

Installation Instructions

NZ & AU

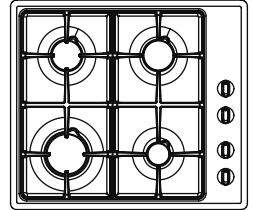

CG603 SERIES

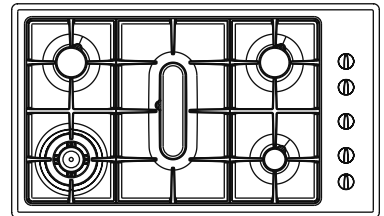
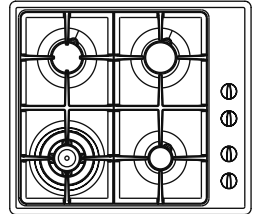

CG903 SERIES

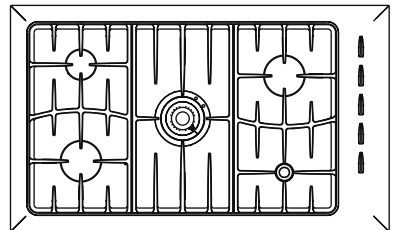

CG913 SERIES

Safety & Warnings

 WARNING	
	<p>Cut Hazard</p> <p>Beware of sharp edges when handling stainless steel appliances.</p> <p>Failure to use caution could result in injury or cuts.</p>



WARNINGS!

- Particular attention shall be given to the relevant requirements regarding ventilation.
- This product should not be sealed into the bench with silicone or glue. Doing so will make future servicing difficult. Fisher & Paykel will not be liable for costs associated with releasing such a product, nor for repairing damage that may be incurred in doing this.
- When this product is installed it shall not be used as a space heater, especially if installed in boats or caravans.
- No combustible material or products should be placed on this product at any time.
- Do not spray aerosols in the vicinity of this product while it is in operation.



CAUTION!

- This product must be installed according to these installation instructions and must comply with local building regulations, local gas authority codes and electrical regulations.
- Failure to install the product correctly could invalidate any warranty or liability claims.

IMPORTANT!

- Read these instructions carefully before installing or using this product.
- Please make this information available to the person responsible for installing the product as it could reduce your installation costs.
- These products are registered: in New Zealand at www.ess.govt.nz and in Australia with AGA at www.gas.asn.au.

Before You Start

- Prior to installation, ensure that the local distribution conditions (nature of gas and pressure) and the adjustment of the product are compatible. For adjustment conditions for this product see Gas Rate Summary.
- This gas hob must be connected to a 220V - 240V 50Hz power supply only and must be earthed via the power cord.
- Ensure a suitable disconnection switch is incorporated in the permanent wiring, mounted and positioned to comply with the local wiring rules and regulations. A means of disconnection with at least a 3 mm air gap contact separation in all poles must be incorporated into the fixed wiring in accordance with the wiring rules, unless the local wiring rules allow for alternative means.
- Ensure that there is a power outlet within reach of the cooktop cable (900 mm from the rear right of the product). This must be accessible after installation. The mains cable should not touch any metal parts.
- Make the bench top of a heat resistant material.
- Seal exposed bare edges of the cutout with an oil-based paint or moisture proof polyurethane to prevent possible damage from moisture creeping between the cooktop trim and the benchtop.

Dimensions

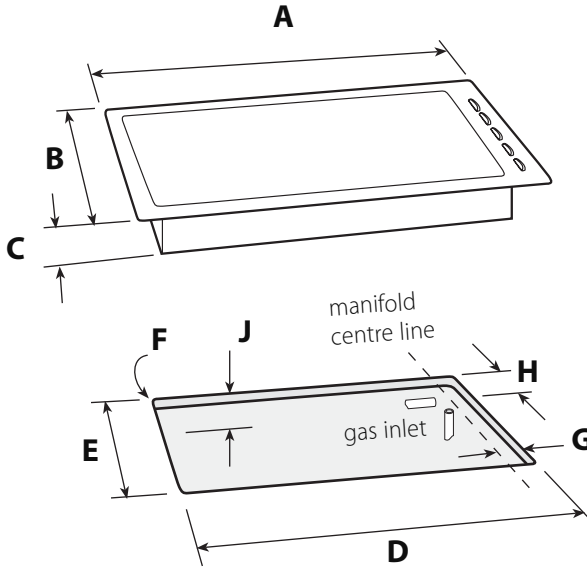

Product	CG603 series	CG903 series	CG913 series
A Width	578	914	914
B Depth	511	533	546
C Height	40	40	76
Pan support to Benchtop	43	43	22
Cutout	CG603 series	CG903 series	CG913 series
D Width	560 (558-562)	870 (846-882)	870 (860-882)
E Depth	490 (485-495)	494 (478-501)	494 (486-524)
F Radius	R10	R10	R10
G	30	30	30
H	40	47	35
J Clearance to nearest combustibile surface	60	60	81

Note:

All measurements given in millimetres (mm).

Cutout dimensions are given as an ‘ideal measurement’ e.g. for new cutouts, followed by an ‘otherwise acceptable range’ (in brackets) e.g. for existing cutouts or replacement products.

Clearances

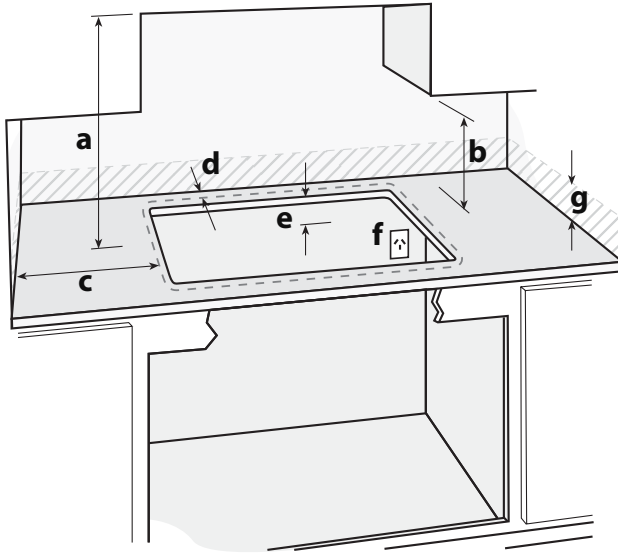

a 600 mm minimum from top of trivet to rangehood.
750 mm minimum from top of trivet to overhead exhaust fan. (Fisher & Paykel splashbacks are 750 mm high).

b 600 mm minimum from top of trivet to downward facing combustable surface. (450 mm minimum if protected by tiles or fire resistant materials).

	CG603 SERIES	CG903 SERIES	CG913 SERIES
c Clearance from side edge of product to any combustable surface	130 mm	120 mm	80 mm
d Clearance from rear edge of product to any combustable surface	100 mm	90 mm	90 mm
Clearance from rear edge of product to any non-combustible surface	10 mm	10 mm	10 mm
e Clearance below benchtop to any combustable surface	60 mm	60 mm	81 mm
Clearance below benchtop to F&P DishDrawer® or F&P oven	45 mm	45 mm	81 mm

f Ensure there is an earthed power outlet within 900 mm of the rear right-hand corner of the product. When used with a flexible hose, the connector on the wall should be between 800 mm to 850 mm above the floor and in the region outside the width of the appliance to a distance of 250 mm. This should be accessible with the appliance installed.

g When protecting a wall with non-combustible material it must be at least 150 mm high.

Installation Instructions

Standards Requirements

Australian and New Zealand Gas Installation Standards (AS5601, NZS 5261) require a cooktop to be installed so that the surface temperature of any nearby combustible surface will not exceed 65°C above ambient.

Typically this is achieved by:

A Having the cooktop spaced away from the wall (see "Clearances" for dimensions) [Dimension **c** and **d**]

OR

B by protecting the wall, to at least 150 mm high [Dimension **g**] along it's length, with non-combustible surface materials, such as:

- 5 mm thick ceramic tiles alone are adequate.
- Tempered glass or sheetmetal (min. 0.4 mm thick) is acceptable when used in front of a fire resistant material.
- Fisher & Paykel Splashback (not available in Australia): This is stainless steel with a 10 mm air gap to the wall. When used with a 10 mm gap behind the product to the front of the splashback. (Only with SB90 series and SB1216 splashbacks.)

These products meet the Standards requirements when installed to the dimensions in these Instructions. (They have been tested by an Independent Testing Lab).

Clamping Down the Cooktop

This cooktop is supplied with fastening clamps that will cope with a bench thickness of 20-50 mm. For benchtops thicker than 50 mm, recess the underside to a thickness of 20-50 mm.

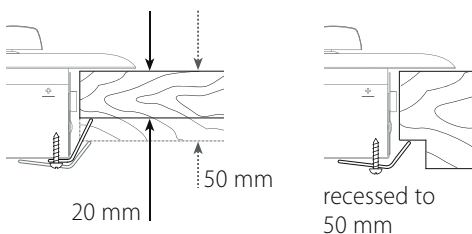

Gas Supply Connection

- **This cooktop is supplied set up for Natural Gas** but is suitable for installation with either Natural Gas or LPG. Refer to relevant table for pressures and appropriate orifice sizes.
- Gas connection to the product **MUST** use the elbow supplied. The regulator will not seal if installed without it.
- Ensure the blue washer (supplied) is located between the elbow (supplied) and product inlet as below. Failure to use this washer will cause the product to leak. Tighten the floating nut to firm finger tight, plus an additional 1/4 turn (90°).

CG603, CG903

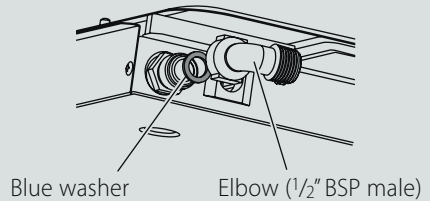

CG913 series

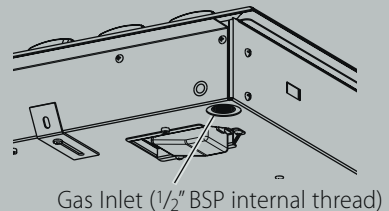

- **After installation, make sure all connections are gas tight.**
- A duplicate data plate enclosed inside the accessories pack should be placed on an accessible surface adjacent to the cooktop.

Flexible Hoses

- Flexible hose assemblies should be AS/NZS 1869 Class B or Class D certified.
- Flexible hoses should not be exposed to temperatures exceeding their certified value. They should not touch hot surfaces on the cooktop or neighbouring products.
- Flexible hoses should not be subject to abrasion, kinking or permanent deformation.

Installation Instructions

Natural Gas

- For Natural Gas usage the gas supply is connected to the regulator which is supplied loose with a built in test point - 1kPa (4" WG) and the inlet connection of 1/2" B.S.P. (male thread). Do not over tighten.
- The test point pressure should be preset to 1.0 kPa with the wok and semi - rapid burners operating at maximum.

LP Gas

- For LPG usage the gas supply for the appliance must be regulated to a pressure of 2.75kPa (11" WG). See 'Conversion to a different gas type'.

Gas Supply Connection Check

- The connection point shall be accessible with the appliance installed.
- To enable the gas supply to be readily shut off, the gas supply must be connected with an isolating valve close to the product.
- After installation and making all connections check thoroughly for possible leaks.

- 1 Turn all control knobs on the unit to "off" position.
- 2 Open the valve on the gas supply.
- 3 Using a suitable leak detection fluid solution (e.g. Rocol) check each gas connection one at a time by brushing the solution over the connection.
- 4 The presence of bubbles will indicate a leak. Tighten the fitting and recheck for leaks. Ensure the washer (supplied) is located between elbow and product gas inlet.
- 5 Turn on each gas valve and light each burner.
- 6 Check for a clear blue flame without yellow tipping. If burners show any abnormalities, check that they are located and assembled properly. Check correct orifices are installed.

The operation of the appliance, including the ignition system, must be tested before installation is complete. If after following the instructions given, satisfactory performance cannot be obtained, contact the local gas authority or your local Approved Service Agent for advice and assistance.

Conversion to Different Gas Type

- Burners can be used with NG or LPG, provided that the orifices appropriate for the gas supply are installed.
- To change the orifices, you will need a 7 mm box spanner (and a 10 mm ring spanner for CG913TM).

- 1 Turn off the main electrical supply.



WARNING!

Electrical Shock Hazard.

Disconnect product from main power supply before continuing.

- 2 Ensure all gas valves are turned off.
- 3 Remove all trivets and burner heads.
- 4 Pull off knobs.
- 5 Unscrew the orifices and replace them with the correct ones. (size numbers are stamped on the side, eg. 70= 0.70 mm) (see figure 1)
- 6 Remove the 2 screws holding each burner (3 on the wok burner).

- 7 Lift hob tray from the product.



WARNING!

Cut Hazard.

Beware of sharp edges.

CG913TM only

- 8 Replace the wok orifice with the correct one using a 10 mm spanner.
- 9 Reset the venturi (see fig.2). Loosen the venturi screw, move the venturi toward the orifice approx. 2 mm.
- 10 To refit the CG913 series hob tray, repeat steps 6 and 7 in reverse.

- 11 Check insulation resistance and earth continuity.

continued...

Installation Instructions

- 12 Turn on main electrical supply and light the burners.
- 13 Important! Reset the minimum setting (see 'Minimum Setting or Turndown').
- 14 Check all burners have good flame (see fig.3,4,5).

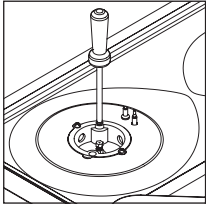

figure 1

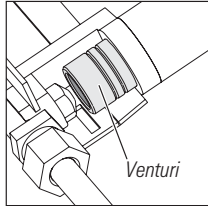

figure 2

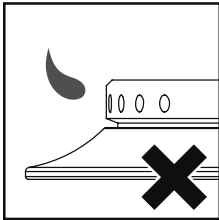

figure 3

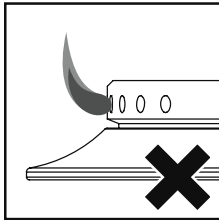

figure 4

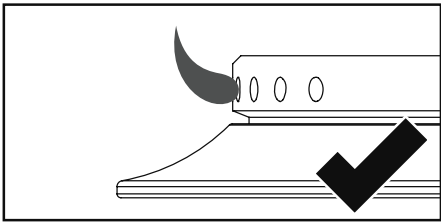

figure 5

Note: CG913TM models may require progressive venturi adjustment on the wok burner:

Fig.3 Lifting Off - move the venturi closer to the orifice.

Fig.4 Yellow Tipping - move the venturi away from the orifice.

Fig.5 Good Flame.

The label supplied with the orifices should be placed over the existing gas type label located on the underside of the product to indicate the gas change.

Minimum Setting or Turn Down

- This has been set at the factory for NG but may need adjusting for local conditions.
- When converting to LPG, the minimum setting **MUST** be reset for each burner.
- To adjust the minimum setting you will need a $\varnothing 2.5 \times 45$ mm screwdriver.

- 1 Ignite the burner and set the knob to its minimum position.
- 2 Remove the knob.
- 3 Rotate the turn down screw slowly until a minimum regular flame is achieved. (The flame will diminish when the screw is turned clockwise and increase when turned anti-clockwise (see fig.6).
- 4 Replace the knob.
- 5 When the setting is right check regulation by quickly rotating the knob from the maximum to the minimum delivery position. The flame must not go out.

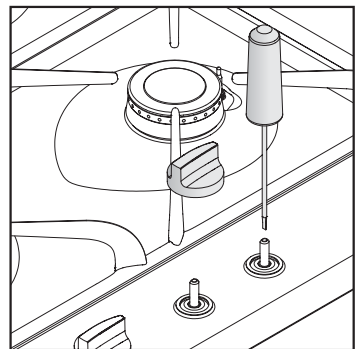

figure 6

Installation Instructions

Gas Rate Summary

Burners	Natural Gas		LPG	
	Orifice size	MJ/h@1 kPa	Orifice size	MJ/h@2.75 kPa
CG603				
Auxiliary Burner (RH front)	0.85 mm	3.6 MJ/h	0.55 mm	4.0 MJ/h
Semi-Rapid Burner (LH & RH rear)	1.3 mm	8.5 MJ/h	0.8 mm	8.5 MJ/h
Wok Burner (LF front)	1.75 mm	15 MJ/h	1.00 mm	13.5 MJ/h
Rapid Burner (LH front)	1.55 mm	12 MJ/h	0.95 mm	12 MJ/h
CG903				
Auxiliary Burner (RH front)	0.85 mm	3.6 MJ/h	0.55 mm	4.0 MJ/h
Semi-Rapid Burner (LH & RH rear)	1.3 mm	8.5 MJ/h	0.80 mm	8.5 MJ/h
Fish Burner (Centre)	1.55 mm	12 MJ/h	0.95 mm	12 MJ/h
Wok Burner (LH front)	1.75 mm	15 MJ/h	1.00 mm	13.5 MJ/h
GC913T				
Simmer Burner (RH front)	0.85 mm	3.6 MJ/h	0.45 mm	2.7 MJ/h
Semi-Rapid Burner (LH rear)	1.22 mm	7.2 MJ/h	0.7 mm	6.2 MJ/h
Rapid Burner (LH front & RH rear)	1.45 mm	10.5 MJ/h	0.85 mm	9.3 MJ/h
Wok Burner (Centre)	1.80 mm	15.5 MJ/h	1.05 mm	14.5 MJ/h
CG913TM				
Simmer Burner (RH front)	0.85 mm	3.6 MJ/h	0.45 mm	2.7 MJ/h
Semi-Rapid Burner (LH rear)	1.22 mm	7.2 MJ/h	0.7 mm	6.2 MJ/h
Rapid Burner (LH front & RH rear)	1.45 mm	10.5 MJ/h	0.85 mm	9.3 MJ/h
Wok Burner (Centre)	1.90 mm	16.3 MJ/h	1.10 mm	15.3 MJ/h

Customer Care

New Zealand

P.O. Box 58732, Greenmount, Auckland.

Toll Free 0800 FP CARE (0800 37 2273)

Fax 09 273 0656

Email customer.care@fp.co.nz

Australia

P.O. Box 798, Cleveland, QLD 4163.

Toll Free 1300 650 590

Tel 07 3826 9100

Fax 07 3826 9298

Email customer.care@fp.com.au

Current Information

Current Installation Instructions, Product dimensions and specifications are available on the Fisher & Paykel web site:

www.fisherpaykel.com