

Series 9, Contemporary Double DishDrawer Dishwasher

Series 9 | Contemporary

Stainless Steel



Wash one drawer while you load the other, with room in each drawer for full-size dinner plates.

- Designed to be installed under your benchtop, with recessed handles for a seamless look
- Six wash programs, as well as additional Quick wash, Sanitise and Extra Dry modifiers

- Flexible racking allows you to customise internal shelves to suit your needs
- Wi-Fi enabled and works with the SmartHQ™ app for remote control and notifications

DIMENSIONS

Height	820 - 880 mm
Width	599 mm
Depth	573 mm

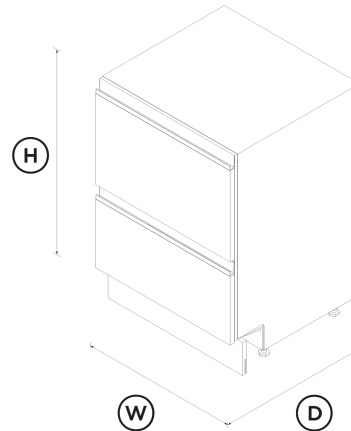

FEATURES & BENEFITS

Seamless Fit

Our built-under DishDrawer™ Dishwashers are installed flush under your benchtop with the option of a custom kickstrip, ensuring minimal gaps. The touch-sensitive control panel is located inside this model, leaving an uninterrupted exterior. Designed to match the Fisher & Paykel family of kitchen appliances with recessed handles for a streamlined look.

Ease Of Use

DishDrawer™ Dishwashers are as easy to open and close as kitchen drawers and can be conveniently positioned at bench height for ease of loading and minimal bending. Flexible racking allows you to make adjustments to fit in a variety of dishes.

Quick, Sanitise And Extra Dry Options

The Quick wash modifier delivers a faster wash while maintaining performance. The Sanitise option provides extra protection, killing 99.9% of bacteria* in the final rinse. The Extra Dry setting is perfect for plastic dishes.

*Certified to NSF/ANSI Standard 184

True Half Load

Each drawer holds a true half load for small, fast washing that won't waste water. Both drawers operate independently so two wash cycles can operate simultaneously to allow for varying loads.

Knock To Pause

For ease-of-use, these DishDrawer™ Dishwashers have a knock to pause function. A knock on the front panel will pause the dishwasher, which can be restarted by using the start button.

Independent Wash

With the ability to use both drawers independently and select different wash programs, the DishDrawer™ Dishwasher can wash everything from fine glass and crystal to heavily soiled pots and pans.

Quiet Performer

Running at a very low decibel rating, these DishDrawer™ Dishwashers do their job without making a fuss. The combination of intelligent technology and simple mechanics means greater reliability and excellent wash performance.

SPECIFICATIONS

Accessories (included)

Cutlery basket	•
Kickstrip	true
Knife clip and multipurpose clip	•

Capacity and loading

Accommodates round plates up to	280mm
Adjustable height, foldable cupracks	•
Fold down tines	•
Pitch adjustable tines	•
Place settings	14
Place settings	14
Place settings per drawer	7
Place settings per drawer	7

Consumption

Energy rating	3.5 star
Energy usage	136kWh/year per drawer
In-use energy carbon emissions estimate	88.6kgCO2e/year per drawer
Water consumption (per wash cycle)	6.9L per drawer
Water rating	4.5 star (WELS)

Controls

End of cycle beeps	•
Energy saving delay start option of up to 12 hours	•
Internal wash selector	•
Keylock	•
Knock to pause	•
Rinse aid indicator light	•
Smart appliance	•

Features

Fan assisted drying	•
Flood protection	•
Flow through detergent dispenser	•
Motor type	BLDC
Quiet operation	•
SmartDrive™ technology	•

Performance

Noise on standard cycle top drawer	42 dBA
------------------------------------	---------------

Power requirements

Amperage	10A
Supply frequency	50Hz
Supply voltage	220 - 240V

Product dimensions

Depth	573 mm
Height	820 - 880 mm
Width	599 mm

Warranty

Parts and labour	2 years
------------------	----------------

Wash Program Modifiers

Extra Dry	•
Quick	•
Sanitise	•
Wash modifiers	3

Wash Programs

Delicate	•
Eco	•
Fast	•
Heavy	•
Medium	•
Rinse	•
Wash programs	6

Water connection

Water pressure	30kPa - 1000 kPa
Water supply	3/4" BSP (20mm) Connector Water Inlet Hose

SKU

82880



A PEACE OF MIND SALE
24 Hours 7 Days a Week Customer Support
T 1300 650 590 W www.fisherpaykel.com

The product dimensions and specifications in this page apply to the specific product and model. Under our policy of continuous improvement, these dimensions and specifications may change at any time. You should therefore check with Fisher & Paykel's Customer Care Centre to ensure this page correctly describes the model currently available. © Fisher & Paykel Appliances Ltd 2020

Other product downloads available at fisherpaykel.com

- [↓](#) 2D-DWG DishDrawer™ Dishwasher
- [↓](#) 2D-DXF DishDrawer™ Dishwasher
- [↓](#) Energy Label DishDrawer™ Dishwasher
- [↓](#) Service & Warranty
- [↓](#) Installation Guide Double DishDrawer™ Dishwasher
- [↓](#) User Guide DishDrawer™ Dishwasher
- [↓](#) Wash Program Data ASNZS DishDrawer™ Dishwasher

Where applicable:

All appliances use energy, and energy usage typically generates carbon emissions. **Fisher & Paykel Appliances' In-use Energy Carbon Emissions Estimate** indicates carbon emissions from a product's in-use energy. This is calculated either annually or per cycle, using the product's market-specific energy label energy consumption data multiplied by the carbon emissions factor for energy in your country or region.

Our In-use Energy Carbon Emissions Estimate is designed to assist customers in making informed purchasing decisions when comparing different Fisher & Paykel products. For example, a heat pump dryer typically has a lower In-use Energy Carbon Emissions Estimate than a vented dryer.