

**FISHER & PAYKEL**

**WASHSMART™ ECO, WASHSMART™  
AND QUICKSMART™ WASHERS**

---

WA1060E, WA8560E, WA7560E,  
WA1060G, WA9060G, WA8560G, WA7060G  
& WA7060M models

**INSTALLATION GUIDE / USER GUIDE  
NZ AU SG ROW**



## CONTENTS

---

Safety and warnings	4
Installation instructions	6
Before your first wash	12
Washer safety features	13
Control panel	14
Wash cycles	18
Eco Active™ wash — WashSmart™ Eco washer only	21
Wash preparation	22
Getting started quickly	25
Wash options	27
Customising a wash cycle	32
Changing pre-set options	34
Caring for your washer	41
Before you call for service	45
Fault codes	47
Troubleshooting	48
Manufacturer's warranty	52
Customer care	54

---

### Registration

To register your product visit our website: [fisherpaykel.com/register](http://fisherpaykel.com/register)

### **⚠ WARNING!**



#### **Electrical Shock Hazard**

**Failure to follow this advice may result in electrical shock or death.**

- If you are using an extension cord or a portable electrical outlet device (eg multi-socket outlet box), ensure that it is positioned so that it does not come into contact with water or moisture.

## **READ AND SAVE THIS GUIDE**

**When using your clothes washer, follow basic precautions, including the following:**

### **General**

- This product has been designed for personal, family or household use. This product is not designed for any commercial use. Any commercial use will terminate this products manufacturer's warranty.
- A damaged power cord must be replaced by a Fisher & Paykel trained and supported service technician or qualified person in order to avoid a hazard. Do not use the appliance until it has been repaired to avoid a risk of electric shock.
- Do not operate this machine if it has been damaged during transport. Contact your Fisher & Paykel dealer or Fisher & Paykel trained and supported service technician.
- This clothes washer is not intended for use by persons (including children) with reduced physical, sensory or mental capabilities, or lack of experience and knowledge, unless they are supervised or given instructions on how to use the washer by someone responsible for their safety.
- Keep children away from the washer while it is in operation.
- Supervise children to ensure they do not play with the washer or climb inside the drum.
- The washer should only be used for washing and rinsing of textiles where this is indicated on the care label.
- Do not add petrol, dry-cleaning solvents, or other flammable or explosive substances to the wash water. These substances give off vapours that could ignite or explode.
- Do not wash articles that have been previously cleaned in, washed in, soaked in, or spotted with gasoline, dry-cleaning solvents, or other flammable or explosive substances as they give off vapours that could ignite or explode.
- The lid will be locked for some parts of the wash cycle for safety reasons. It is possible to open the lid during the cycle under certain conditions. Never force the lid open.
- Do not touch or operate the machine with wet hands or with bare-feet.
- Ensure the installation provides accessibility to the plug or incorporate a switch in the fixed wiring in accordance with the wiring rules to allow disconnection of the appliance from the supply after installation.
- Read and follow the detergent manufacturers' instructions carefully. Instructions on how to use the detergent will be clearly indicated on the pack. Remember to store your detergents out of the reach of children.

## SAFETY AND WARNINGS

MODEL CODE	MAX CAPACITY* (KG)
WA7060M	7
WA7060G	7
WA7560E	7.5
WA8560E	8.5
WA8560G	8.5
WA9060G	9
WA1060G	10
WA1060E	10

\*Capacity refers to the maximum dry weight of items the washer can wash at any one time.

The WA1060E, WA1060G and WA9060G models have a different capacity based on country standards. Refer to the serial plate on the back of the product.

- Do not overload your washing machine beyond its rated capacity.
- Do not wash an electric blanket in your washer unless the care label specifically states it is safe to do so.
- Do not wash curtains in this washer, as sunlight makes them brittle and they may disintegrate during washing.
- The only user-removable parts of the washer are the inlet hose(s) and agitator. No other parts are designed to be removed by anyone other than a Fisher & Paykel trained and supported service technician.

### Installation

- For guidance on how to install your product, please refer to installation instructions contained in this document.

### Water supply requirements:

- Inlet water pressure: Max. 1MPa (145psi), Min. 34kPa (5psi)
- Inlet water flow rate: Min. 8 litres/minute
- A pressure-reducing valve must be installed if pressure is higher than 1MPa.
- For optimum wash performance check the supply pressure is within the recommended range.
- New hose sets provided with the washer should be used to connect the washer to the water mains. Old hose sets should not be re-used.
- We recommend the inlet hose(s) are changed every 5 years. WARNING: Failure to do so may result in a flood and damage to property.
- The hot water temperature should not exceed 65°C and the cold water temperature not exceed 35°C. Temperatures above these may cause the machine to fault or cause damage to the machine.
- Install the machine on a solid and level floor surface ensuring it has at least 20 mm clearance on each side. The washer must not be installed on any textured floor coverings (eg carpet, rugs).

### Disposal

- When disposing of the washer, it is recommended that the lid is removed to avoid children getting trapped inside, and that the electrical cable is cut off close to the washer.

# INSTALLATION INSTRUCTIONS

## Accessories

Check if you received the following accessories with your Fisher & Paykel washer. You will find them inside the drum or attached to the packaging.

- 1 x hose guide
- 2 x inlet hoses

## Unpacking

To ensure the best performance from your new washer please follow the instructions below.

### Removing the packaging

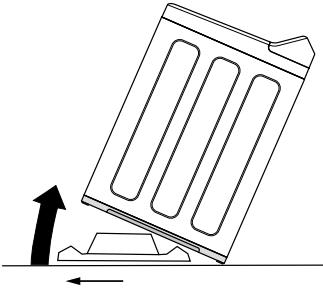

- ① Remove the outer packaging.
- ② Tilt the washer backwards and walk it off the base packer one foot at a time (ensure the lid is still taped down).
- ③ Remove the base packer from under the washer by tilting the washer backwards and pulling the packer out the front.
- ④ Remove the tape, lift the lid and remove the bowl packer from the bowl.
- ⑤ Remove the hoses and accessories.
- ⑥ Keep the base packer and bowl packer in case they are required for future transit.

Ensure that the base packer has been removed before operating your washer.

# INSTALLATION INSTRUCTIONS

## Product and minimum clearance dimensions

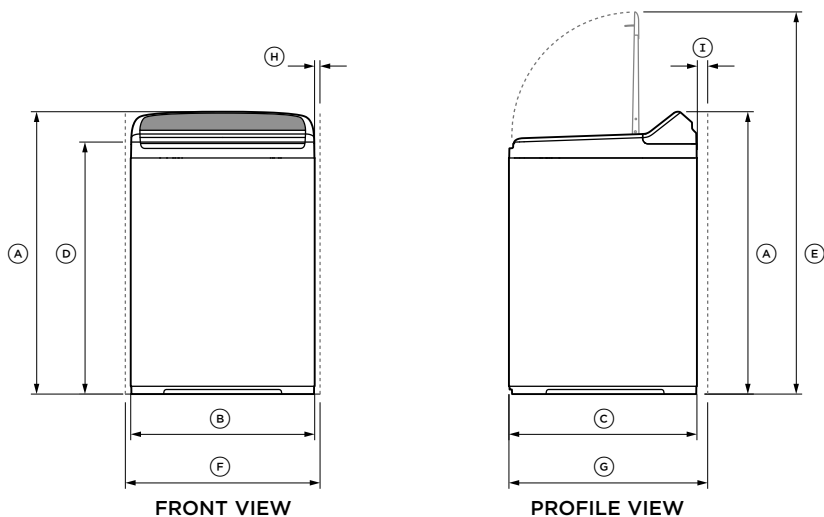

	<b>WA**60*</b>
<b>PRODUCT DIMENSIONS</b>	<b>MM</b>
Ⓐ Overall height of product † (to highest point on console)	1045 - 1075
Ⓑ Overall width of product	600
Ⓒ Overall depth of product	600
Ⓓ Height of product lid closed	950 - 980
Ⓔ Height of product lid open	1350 - 1385
Standpipe height	min. 850 - 1200
<b>MINIMUM CLEARANCES</b>	<b>MM</b>
Ⓕ Minimum cavity width	640
Ⓖ Minimum depth clearance (incl. inlet hoses, drain hose and bowed front)	660
Ⓗ Minimum clearance to either side, wall or adjacent product#	20
Ⓘ Minimum clearance at the rear of the product	50

\*The exact height of your washer is dependent on how far the feet are extended from the base of the washer.

#Applies either side.

# INSTALLATION INSTRUCTIONS

## Levelling instructions

It is **IMPORTANT** to level the washer to ensure good spin performance.

A level is provided with your washer. The washer is level when the bubble sits in the centre, within the two lines.

Your washer is equipped with self-locking feet at the front to ensure they do not move once you have levelled your washer. Move the washer using the top corners, do not push the centre front of the washer.

After levelling, the corners of the washer should be clear of the floor and the washer must not rock in any direction.

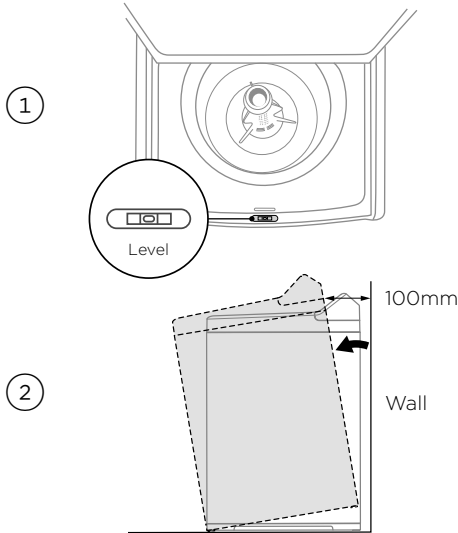

Move the washer to its final position allowing for required clearances.

Level the washer side to side:

- Open the lid and place level at the centre front of the top deck (forward of the lid lock slot). Wind the front feet up or down.

Release the rear feet:

- Close the lid and tilt washer forward away from the wall. Gently lower washer down.

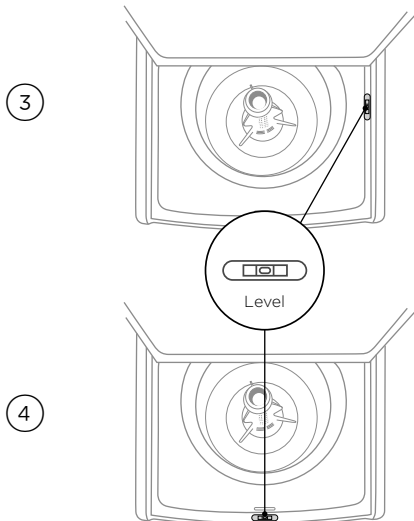

Level the washer front to back:

- Open the lid and place the level on one side of the top deck. Wind both front feet equally.
- To release back feet, tilt the washer forward.

Re-check the washer is level:

- Place the level at the centre front of the topdeck (forward of the lid lock slot).
- Ensure washer does not rock in any direction.
- If washer is not level repeat the above steps.

**If moving or transporting your washer ensure you tape the lid down.**



# INSTALLATION INSTRUCTIONS

## Water supply

### Inlet hoses

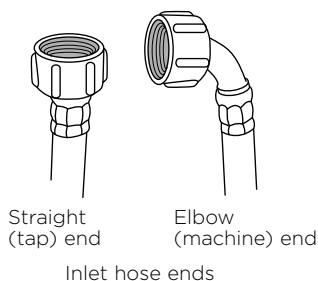

- ① Connect the straight ends of the inlet hoses to the taps (there are washers fitted in both ends). Connect the red connector hose to Hot, and the white connector hose to Cold.
- ② Connect the elbow ends of the inlet hoses to the corresponding washer inlet valves. Inlet valves are marked on the back of the washer. Ensure the Hot valve is connected to the hot tap and the Cold valve is connected to the cold tap.

H = Hot C = Cold

**Only use the new hose set provided with your washer.**

### Water supply requirements:

- If you have an uncontrolled water heating source (eg a wet back or solar heating system) you should fit a tempering valve. This will ensure the hot water temperature remains within safe limits. Contact your registered plumber to select and install the tempering valve.
- Your cold water should not exceed 35°C and your hot water should not exceed 65°C. Temperatures above these may cause the machine to fault or cause damage to the machine.
- Inlet water static pressure: Max. 1MPa (145psi) Min. 34KPa (5psi).
- Inlet water flow rate at tap: Min. 8 litres/min.

### Cold water supply only:

If you only have a cold water supply, a blanking cap **MUST** be connected to the Hot inlet valve. The cap prevents water leaking out of the hot valve. The cap is available from your Fisher & Paykel dealer or Fisher & Paykel trained and supported service technician, Part No. 388491P. This appliance incorporates backflow protection complying with AS3500.1. No further backflow protection is required for connection to the water supply.

Your washer does not have an internal heater to heat water.

Should you wish to use cold water only for all wash cycles, refer to 'Customising wash cycles' on how to program your washer to remember your wash preferences.

# INSTALLATION INSTRUCTIONS

## Draining

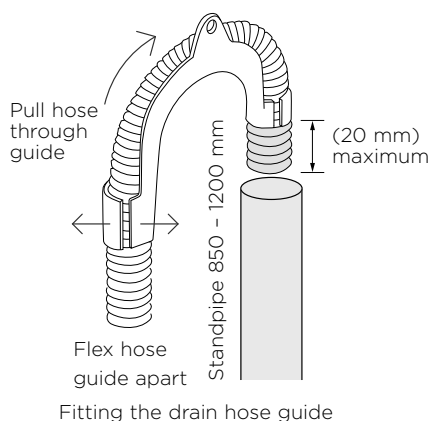

### Placing the drain hose in a standpipe or tub:

- ① Carefully pull the drain hose out from the back of the washer by pulling the exposed part of the hose downward and outward.
- ② To guide the drain hose over the tub or standpipe the hose guide **MUST** be fitted to the drain hose.
- ③ Place the drain hose in the tub or standpipe. Do not fit the hose to a drain spigot. Drainage must not be airtight in order to prevent siphoning.

**To prevent siphoning the drain hose should not extend more than 20 mm from the end of the guide. The height of the standpipe or tub should be between 850 - 1200 mm. The drain hose can be trimmed to length.**

- Regularly check that your standpipe or tub is free from lint or other obstructions, which may affect how your washer works or may cause flooding.
- In multi-storey apartments or any upper floor, the washer should be installed on a floor equipped with a drain.
- Draining must comply with local by-laws.
- We recommend replacing the inlet hoses every 5 years. Hoses should be checked from time to time and replaced if any wear, cuts, bulges, kinks or leaks are found.

## Electrical connection

- This appliance must be supplied with a 220 - 240V, 50Hz, sinusoidal, 10A electrical supply.
- Check the power cord for damage, making sure it is not squashed or twisted.
- A damaged power cord must be replaced by a Fisher & Paykel trained and supported service technician, in order to avoid a hazard.
- The appliance must not be operated until it is repaired, as there is a risk of electric shock.

<b>SPARE PARTS*</b>	<b>PART NO.</b>
Blanking Cap	388491P
Hose Inlet Long (2 m)	422680P
Hose Inlet Large Bore	426123P
Drain Hose Extension	425627P

\*Available from your Fisher & Paykel dealer or a Fisher & Paykel trained and supported service technician.

# INSTALLATION INSTRUCTIONS

## Completing your installation

- Turn on the water and check all hose connections for leaks. Make sure there are no kinks in the hoses. Check the hose connections for leaks again after 24 hours.
- Uncoil power cord, remove and discard the plastic pin cover, and plug into wall socket.
- Connect the appliance to an earthed outlet protected by a fuse of suitable capacity.

## Installation test cycle

Your washer must be correctly installed before use. Check the installation and operation of the washer using the following procedure:

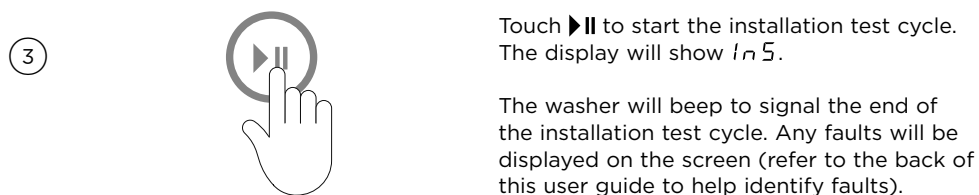
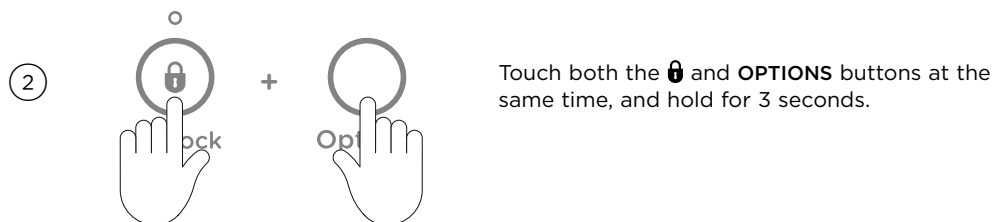

If you need further assistance, please contact a Fisher & Paykel trained and supported service technician or our Customer Care Centre. Refer to 'Customer care' section for contact details.

Note: WA7060M QuickSmart™ washer only—a manual check of the inlet hose connections will be required as the installation test cycle will not verify if the hot and cold inlet hoses are connected the correct way around.

## BEFORE YOUR FIRST WASH

---

### Check you have done everything you need to before you start your first wash:

- Has the basepacker been removed?
- Is the drain hose threaded through the hose guide 'U bend' (with no more than 20 mm extended) and hooked into your standpipe or tub, or attached to a spigot?
- Is the hot hose connected to the hot valve marked 'H'?
- Is the cold hose connected to the cold valve marked 'C'?
- Have the taps been turned on?
- Is the washer correctly levelled, feet are extended and cabinet corners are clear of the floor?
- Has the power cord been connected to an appropriate power supply and the power turned on?
- Have you performed the installation test cycle (see previous page)?

### WashSmart™ washer and QuickSmart™ washer capacities

The table below outlines what is included in a 7kg, 7.5kg, and 8.5kg wash load (in accordance with AS/NZS 2040.1:2005).

WASH LOAD	7 kg	7.5 kg	8.5 kg
Sheets (double)	2	3	3
Bath towels	6	4	5
Tablecloths	2	2	3
Shirts	3	4	5
T-Shirts	4	5	5
Pillowcases	4	4	6
Shorts	7	6	6
Washcloths	6	8	6
Handkerchiefs	4	8	8

#### Note:

- The above load composition is indicative only. We recommend for everyday use that you separate out your sheets and towels and wash them separately on the **REGULAR** cycle.
- The WA1060E, WA1060G and WA9060G models have a different capacity based on country standards. Refer to the serial plate on the back of the product.

## WASHER SAFETY FEATURES

---

### Lid lock

The lid of your washer is locked for some parts of the wash cycle, ensuring safety for you and your family while it is operating.

The **LID LOCKED** light (above the ►|| button) is illuminated when the lid lock is activated, letting you know at a glance if you can open the lid or not.

**To unlock the lid at any time during the cycle touch ►|| .**

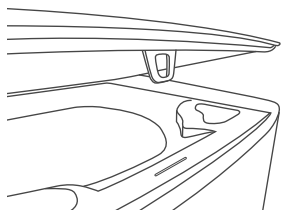

If the lid is left open, your CleanSmart™ washer will be unable to lock the lid, and the cycle will be halted. The washer will beep to alert you and display a warning message on the screen. If this occurs, ensure that the lid is closed and touch ►||.

**Do not put anything down the lid lock slot in the top deck of your washer.**

**Do not try to disable the lid lock.**

### Auto drain

- Unsupervised clothes washers filled with water can present a drowning hazard to small children. In order to minimise any risk of this type of accident, your washer has been pre-programmed to know when this potential hazard is created and drains the wash water to a safe level.
- If you pause or power off your washer at any time during the wash cycle when there is water in the bowl, the washer will activate the auto drain function after 3 minutes. This will drain the water in the wash bowl to an acceptable level, minimising any potential hazard.
- A warning message *RdR* will be displayed on the digital display while auto drain is in operation. The cycle can be restarted at anytime by touching ⓘ and/or ►|| .

# CONTROL PANEL

## Washsmart™ Eco Washer

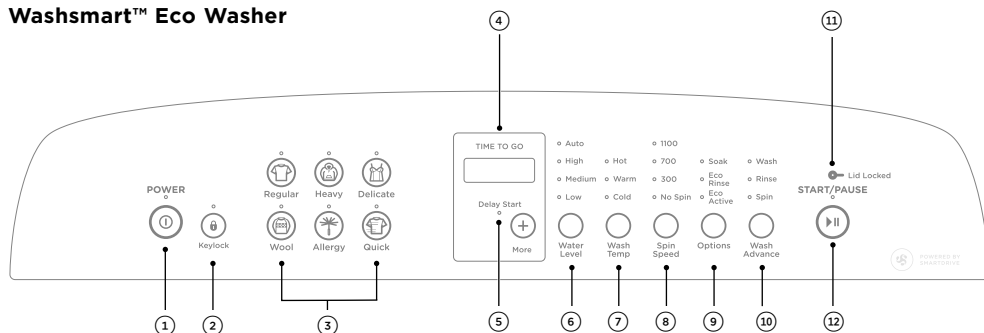

①	<b>POWER</b>	Touch to turn the washer ON/OFF.
②	<b>Keylock</b>	Touch and hold to disable all buttons on the display panel, except ①. This prevents accidental button presses.
③	<b>Wash cycles</b>	Touch to select the desired cycle for your load.
④	<b>Digital display screen</b>	Shows the following: <ul style="list-style-type: none"> <li>• 'Time to go' - the remaining time in the cycle that is currently running.</li> <li>• Delayed start time of wash cycle.</li> <li>• Notifications if an error is detected or a warning is necessary.</li> </ul>
⑤	<b>Delay Start</b>	Touch to increase or decrease the delay start time.
⑥	<b>Water level</b>	Touch to select the water level for your wash. If Auto is selected your wash will automatically select the most efficient water level for the load.
⑦	<b>Wash Temp</b>	Touch to select the water temperature.
⑧	<b>Spin Speed</b>	Touch to select the washer spin speed.
⑨	<b>Options</b>	Touch to select Eco Active, Eco Rinse or Soak.
⑩	<b>Wash Advance</b>	Touch to advance the current cycle or to start a cycle at a particular stage.
⑪	<b>Lid Lock</b>	Illuminates to indicate the lid of the washer is locked. To open the washer pause the cycle.
⑫	<b>START/PAUSE</b>	Touch to start or pause the selected wash cycle.

# CONTROL PANEL

## Washsmart™ Washer

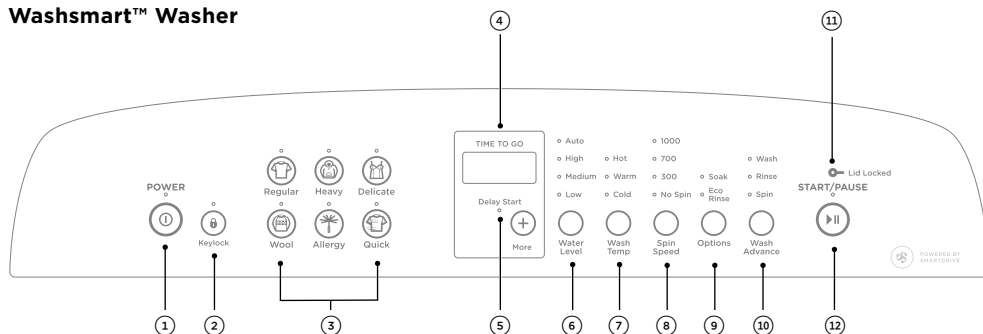

① <b>POWER</b>	Touch to turn the washer ON/OFF.
② <b>Keylock</b>	Touch and hold to disable all buttons on the display panel, except ①. This prevents accidental button presses.
③ <b>Wash cycles</b>	Touch to select the desired cycle for your load.
④ <b>Digital display screen</b>	Shows the following: <ul style="list-style-type: none"> <li>• 'Time to go' - the remaining time in the cycle that is currently running.</li> <li>• Delayed start time of wash cycle.</li> <li>• Notifications if an error is detected or a warning is necessary.</li> </ul>
⑤ <b>Delay Start</b>	Touch to increase or decrease the delay start time.
⑥ <b>Water level</b>	Touch to select the water level for your wash. If Auto is selected your wash will automatically select the most efficient water level for the load.
⑦ <b>Wash Temp</b>	Touch to select the water temperature.
⑧ <b>Spin Speed</b>	Touch to select the washer spin speed.
⑨ <b>Options</b>	Touch to select Eco Rinse or Soak.
⑩ <b>Wash Advance</b>	Touch to advance the current cycle or to start a cycle at a particular stage.
⑪ <b>Lid Lock</b>	Illuminates to indicate the lid of the washer is locked. To open the washer pause the cycle.
⑫ <b>START/PAUSE</b>	Touch to start or pause the selected wash cycle.

# CONTROL PANEL

## Quicksmart™ Washer

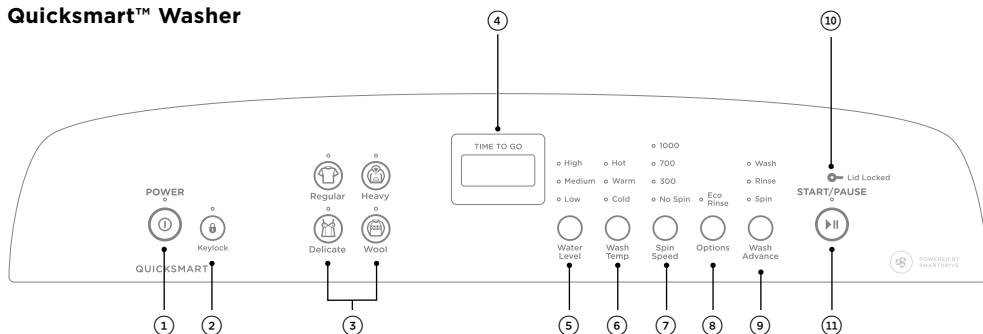

① <b>POWER</b>	Touch to turn the washer ON/OFF.
② <b>Keylock</b>	Touch and hold to disable all buttons on the display panel, except ①. This prevents accidental button presses.
③ <b>Wash cycles</b>	Touch to select the desired cycle for your load.
④ <b>Digital display screen</b>	Shows the following: <ul style="list-style-type: none"> <li>• 'Time to go' - the remaining time in the cycle that is currently running.</li> <li>• Notifications if an error is detected or a warning is necessary.</li> </ul>
⑤ <b>Water level</b>	Touch to select the water level for your wash. If Auto is selected your wash will automatically select the most efficient water level for the load.
⑥ <b>Wash Temp</b>	Touch to select the water temperature.
⑦ <b>Spin Speed</b>	Touch to select the washer spin speed.
⑧ <b>Options</b>	Touch to select Eco Rinse.
⑨ <b>Wash Advance</b>	Touch to advance the current cycle or to start a cycle at a particular stage.
⑩ <b>Lid Lock</b>	Illuminates to indicate the lid of the washer is locked. To open the washer pause the cycle.
⑪ <b>START/PAUSE</b>	Touch to start or pause the selected wash cycle.



## CONTROL PANEL

### Keylock

Keylock can be used to lock the buttons on your washer when not in use. This will avoid accidental button pushes from items left on the lid of the washer and also from any little fingers.

To turn Keylock ON or OFF:

①



Touch and hold the  button for two seconds.

When activated, the light above the  button is illuminated.

If Keylock is ON:



①



To turn your washer on, touch  button for two seconds. This will activate the display panel. **KEYLOCK** will remain activated but let you select your wash cycle options and start the cycle.



②



To pause your washer at any time during the cycle, touch and hold the  button for 2 seconds, or touch the  button twice in quick succession.

③



To stop your washer or power off at any time, touch the  for two seconds or touch the  button twice in quick succession.

## WASH CYCLES

### Wash cycle guide - Washsmart™ Eco Washer

Your washer has a number of wash cycles to suit your laundering needs. Selecting the most appropriate cycle for each particular wash load will help ensure you get the best wash result.

CYCLE	DESIGNED FOR	WASH TIME* (MIN)	WASH ACTION	WASH TEMP.	RINSE	SPIN SPEED (RPM)	SPIN TIME** (MIN)
<b>Regular***</b>	For normally soiled everyday cotton loads, eg t-shirts, shorts, shirts.	11	Regular	Warm/ Cold	Spray/ Deep Rinse	1100	6
<b>Heavy</b>	Recommended cycle for heavily soiled durable garments, eg tea towels, children's clothes.	13	Heavy	Warm	Spray/ Deep Rinse	1100	6
<b>Delicate</b>	Designed for delicate lightly soiled clothes.	5	Delicate	Warm/ Cold	Spray/ Deep Rinse	300	2
<b>Wool</b>	Designed for machine washable woollen items.	5	Wool	Warm/ Cold	Spray/ Deep Rinse	700	4
<b>Allergy</b>	Recommended cycle for people with skin and other sensitivities.	11	Regular	Hot	Spray/ 2 Deep rinses	1100	6
<b>Quick</b>	For washing lightly soiled garments in a faster time.	5	Regular	Warm/ Cold	Spray/ Deep Rinse	1100	2

\* Refers to the agitation time in the 'wash' part of the cycle, not the total time taken to complete a cycle.

\*\* Refers to the length of time when at the maximum spin speed.

\*\*\* The **REGULAR** cycle, 'Auto' water level, 'Warm/Cold' wash temp, '1100' spin speed, 'Eco Active' and 'Eco Rinse' selected is the recommended water and energy saving cycle for normally soiled, everyday washing.

Note: For users in markets with cold supply only, the wash temperature will default to cold wash temperature.

## WASH CYCLES

### Wash cycle guide - Washsmart™ Washer

Your washer has a number of wash cycles to suit your laundering needs. Selecting the most appropriate cycle for each particular wash load will help ensure you get the best wash result.

CYCLE	DESIGNED FOR	WASH TIME* (MIN)	WASH ACTION	WASH TEMP.	RINSE	SPIN SPEED (RPM)	SPIN TIME** (MIN)
<b>Regular***</b>	For normally soiled everyday cotton loads, eg t-shirts, shorts, shirts.	11	Regular	Warm/ Cold	Spray/ Deep Rinse	1000	6
<b>Heavy</b>	Recommended cycle for heavily soiled durable garments, eg tea towels, children's clothes.	13	Heavy	Warm	Spray/ Deep Rinse	1000	6
<b>Delicate</b>	Designed for delicate lightly soiled clothes.	5	Delicate	Warm/ Cold	Spray/ Deep Rinse	300	2
<b>Wool</b>	Designed for machine washable woollen items.	5	Wool	Warm/ Cold	Spray/ Deep Rinse	700	4
<b>Allergy</b>	Recommended cycle for people with skin and other sensitivities.	11	Regular	Hot	Spray/ 2 Deep rinses	1000	6
<b>Quick</b>	For washing lightly soiled garments in a faster time.	5	Regular	Warm/ Cold	Spray/ Deep Rinse	1000	2

\* Refers to the agitation time in the 'wash' part of the cycle, not the total time taken to complete a cycle.

\*\* Refers to the length of time when at the maximum spin speed.

\*\*\* The **REGULAR** cycle with 'Auto' water level, 'Warm/Cold' wash temp, '1000' spin speed and 'Eco Rinse' selected is the recommended water and energy saving cycle for normally soiled, everyday washing.

Note: For users in markets with cold supply only, the wash temperature will default to cold wash temperature.

## WASH CYCLES

### Wash cycle guide - Quicksmart™ Washer

Your washer has a number of wash cycles to suit your laundering needs. Selecting the most appropriate cycle for each particular wash load will help ensure you get the best wash result.

CYCLE	DESIGNED FOR	WASH TIME* (MIN)	WASH ACTION	WASH TEMP.	RINSE	SPIN SPEED (RPM)	SPIN TIME** (MIN)
<b>Regular***</b>	For normally soiled everyday cotton loads, eg t-shirts, shorts, shirts.	11	Regular	Warm	Spray/ Deep Rinse	1000	6
<b>Heavy</b>	Recommended cycle for heavily soiled durable garments, eg tea towels, children's clothes.	13	Heavy	Warm	Spray/ Deep Rinse	1000	6
<b>Delicate</b>	Designed for delicate lightly soiled clothes.	5	Delicate	Warm	Spray/ Deep Rinse	300	2
<b>Wool</b>	Designed for machine washable woollen items.	5	Wool	Warm	Spray/ Deep Rinse	700	4

\* Refers to the agitation time in the 'wash' part of the cycle, not the total time taken to complete a cycle.

\*\* Refers to the length of time when at the maximum spin speed.

\*\*\* The **REGULAR** cycle with 'High' water level, 'Warm' wash temp, '1000' spin speed and 'Eco Rinse' selected is the recommended water and energy saving cycle for normally soiled, everyday washing.

Note: For users in markets with cold supply only, the wash temperature will default to cold wash temperature.

## ECO ACTIVE™ WASH – WASHSMART™ ECO WASHER ONLY

Your FabricSmart™ uses a dual-action wash to give excellent wash performance while taking great care of your clothes. We call this the Eco Active™ wash. The two parts to the Eco-Active™ wash are explained below:

### Detergent activating wash (front-loader type wash)

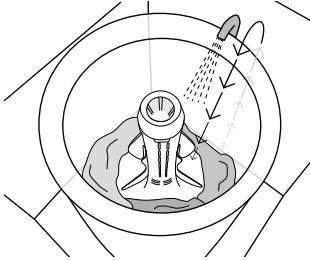

For both ECO ACTIVE™, ON and ECO ACTIVE™, OFF selections, your WashSmart™ washer fills the bowl at the selected temperature with just enough water so that your clothes are 100% saturated. This small amount of water flows down through the clothes, into the bowl base, mixes with the detergent, then is pumped up a specially designed portal and back onto the clothes in a cascade effect. This wash action thoroughly dissolves and activates the detergent.

The concentrated solution of detergent and water rapidly targets stains and soils at the fibre-level of fabrics, boosting soil removal and accelerating the wash process.

### Agitation wash (top-loader type wash)

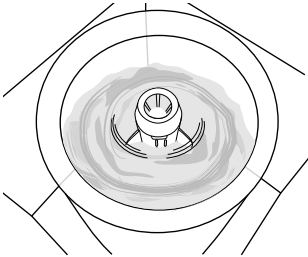

If you have selected ECO ACTIVE™, ON after recirculating the sudsy water through your clothes your WashSmart™ Eco washer will fill with just enough cold water to suspend the clothes in the diluted solution. The flexible finned agitator then provides just enough mechanical action to separate the soil from the clothes.

On WashSmart™ Eco washer the ALLERGY cycle bypasses the detergent activating wash and proceeds directly to the agitation wash.

CYCLE	ECO ACTIVE™ ON	ECO ACTIVE™ OFF
Regular	✓	✓
Heavy	✓	✓
Delicate	✓	✓
Wool	-	✓
Allergy	-	-
Quick	✓	✓

Note: Eco Active™ wash is not available with the WashSmart™ washer or QuickSmart™ washer models.

## WASH PREPARATION

---

### Sorting your load

Sort items according to colour, fabric type, and soil type. Wash fine, delicate fabrics separately from thick, heavy fabrics. Always separate coloured items from whites, especially when they are new. Colour run could be an issue if you wash items at higher temperatures. Some soils, like mud and blood are best washed in cold water. Oily soils (eg some foods and marks on shirt collars) are best washed in warm water.

### Before you load

- Check pockets for items that could damage your clothes or get caught in the washer.
- Close zippers, hooks and eyes, and other fastenings (ie fasten the opening of duvet/ doona covers) and remove loose bra wires. All these can damage both your washer and your clothes.
- Place delicate items, such as lingerie, in a mesh laundry bag before placing in the washer.
- Pre-treat any stains, taking care not to spray pre-treaters on your washer as they can cause damage to the plastic surfaces.

### Ensure the water level suits the load size

If manually selecting the water level, select the correct water level by using the mark on the agitator nearest to the top of the load. Ensure the load does not extend above the bottom of the fabric softener dispenser cup, as splashing may occur.

### For a balanced load

- Place unfolded clothes firmly and evenly around the agitator, no higher than the bottom of the fabric softener dispenser cup.
- Do not wrap large items, such as sheets, around the agitator.
- A mixture of small and large items will wash best.

In the unlikely case of an out of balance load, refer to the 'Levelling instructions' to check the machine is correctly levelled.

# WASH PREPARATION

## Selecting the right detergent

- We recommend using domestic laundry detergent. Use powder or liquid detergent for 'Top Loader' washers.
- When washing wool items, remember to use a detergent specifically recommended for woollens.
- Soap flakes or granulated soap powders should not be used in your washer.
- Pods—Detergent pods are a 'no mess' alternative to powdered or liquid detergent. They should be placed down the centre of the agitator.

## How much detergent?

Follow the instructions on the back of the detergent packet as a guide to the correct amount of detergent to use. The correct amount of detergent will vary, depending on the amount of soil in your clothes and the size of your load. Jeans and work clothes may need more detergent, while towels usually need less. The larger your load, the more detergent you may have to add.

## Adding the detergent

1

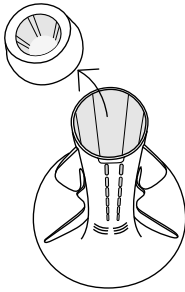

Remove the fabric softener dispenser cup.

2

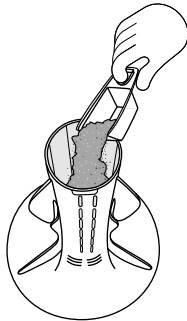

Place pod, pour liquid or powder detergent down the centre of the agitator. Pre-dissolving detergent in warm water (before adding it to the machine) when washing in cold water can improve the performance of the detergent.

Replace the fabric softener dispenser cup (this prevents small articles falling down the centre of the agitator).

## WASH PREPARATION

---

### How the fabric softener is dispensed

The fabric softener goes into the dispenser cup on the top of the agitator. During the rinse the washer spins to release the fabric softener, delivering it down the agitator stem as the washer fills for the final deep rinse.

If fabric softener is not added to the washer correctly, it may contribute to 'scrud' (described below).

Note: The **QUICK** cycle and **ECO RINSE** option are not designed to be used with fabric softener as the fabric softener will not be dispersed correctly.

### How much fabric softener?

Always follow the manufacturer's recommendations on the fabric softener packaging for the correct dosage. The ring on the dispenser cup is a guide only for the maximum amount of fabric softener to add for a full load. Smaller loads require less fabric softener.

### Cleaning the dispenser

When using fabric softener, rinse your dispenser at the end of each wash.

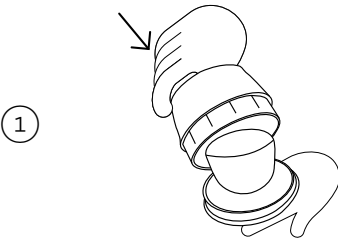

Separate the cup from the dispenser body by pushing downward on the base of the cup.

Rinse both parts of the dispenser using warm soapy water.

### Scrud

Scrud is the name given to the waxy build-up that can occur within a washer when the fabric softener comes into contact with detergent. This can happen when fabric softener is not added to the washer correctly. This build-up is not brought about by a fault in the washer. If scrud is allowed to build up in the washer, it can result in stains on your clothes and/or an unpleasant smell in your washer.

### If you wish to use fabric softener we recommend:

- Using fabric softener sparingly.
- When filling the dispenser, do not splash or overfill.
- Clean the dispenser as soon as the cycle has finished.
- Clean your washer regularly (refer to the 'Caring for your washer' section).
- Cold water washing increases the chance of a build-up of scrud occurring. We recommend a **WARM** or **HOT** wash at regular intervals, eg approximately every 5th wash.
- Fabric softener of a thinner consistency is less likely to leave residue in the dispenser and contribute to a build-up.



## GETTING STARTED QUICKLY

WashSmart™ Eco washer, WashSmart™ washer and QuickSmart™ washer

1



Touch **I** to activate your WashSmart™ washer.

2



Select your desired wash cycle by touching the wash cycle button of your choice (refer to 'Wash cycles' section).

3



Choose your wash options, eg you may want a **WARM** wash temperature and a **SLOW** spin speed.

4



Touch **▶** to start the cycle. The washer will start to fill with water and select the correct wash action for your load.

For best fabric and colour care, remove your clothes as soon as the cycle has finished.

## GETTING STARTED QUICKLY

---

5



Use **lock** mode to lock the buttons on the display, which prevents them from being activated accidentally by a washing basket or little fingers (refer to the 'Washer controls' section).

6

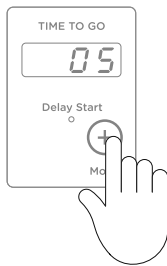

**DELAY START** allows you to delay the start of your wash by 5 mins up to 18 hours (refer to the 'Wash options' section).

**DELAY START** feature not applicable on Quicksmart™ Washer.

7



If you wish to stop your FabricSmart™ washer touch **▶||**.

During a spray rinse or spin, there will be a slight delay while the bowl slows to a stop and the lid is unlocked.

Failure to follow the advice in this guide may result in damage to your garments, and your expectations of wash performance may not be met.

# WASH OPTIONS

## Water Level

Auto water level (not available on QuickSmart™ washer)

1

- Auto
- High
- Medium
- Low



Place your clothes in the machine and select the wash cycle. Press **AUTO** water level if not automatically selected.

2



Touch **▶||**. The machine will automatically fill to the correct water level for the load, for both phases of the wash.

When washing an unusual load, eg large bulky garments, items or pillows, we recommend you select the **DELICATE** cycle. If there is already water in the bowl, it is best to manually select the water level.

### Manual water level selection

The agitator has five levels marked on its stem that can be used to help you select the correct water level. Select the correct water level by using the mark nearest to the top of the load.

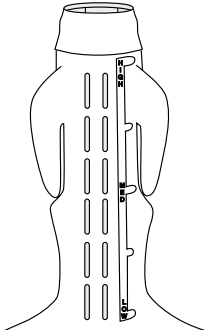

- The levels marked on the agitator do not correspond exactly to the level of the water. They indicate the level of dry clothes suitable for the water level.
- Your washer may occasionally add water during agitation. This is to maintain the water level due to the release of air trapped in the garments.
- Out of balance loads, tangling or splash-over can be caused by selecting a water level that is too high.

## WASH OPTIONS

### Wash temp

WashSmart™ Eco washer and WashSmart™ washer offer 5 wash temperatures, and an additional setting, CONTROLLED COLD.

COLD	CONTROLLED COLD	WARM/COLD	WARM	WARM/HOT	HOT
Incoming from tap	20°C	35°C	40°C	50°C	Incoming from tap

Note: These temperatures are approximate.

The wash temperature selected is used in the detergent activating part of the wash. If **ECO ACTIVE™** is **ON** the temperature will be colder for the second part of the wash. When **ECO ACTIVE™** **OFF** is selected, the bowl will fill with the wash temperature selected.

The temperature of cold tap water varies widely depending on your location and the season. We have developed **CONTROLLED COLD**, which adds a small amount of warm water, when necessary, to raise your cold water wash to 20°C for a more effective wash (refer to the 'Changing pre-set options' section for detail on how to set **CONTROLLED COLD** as the default temperature for your cold water wash).

**QuickSmart™** washer offers three wash temperatures; **COLD** and **HOT** will be the temperature of the water supply.

### WashSmart™ Eco washer only:

For the **ALLERGY** cycle the bowl will fill with water at the temperature selected by the user. There is no **ECO ACTIVE™** section in the wash cycle.

### Spin Speed

Your **WashSmart™ Eco washer** offers three spin speeds: **FAST** (1100 rpm), **MEDIUM** (700 rpm) and **SLOW** (300 rpm), plus an additional **NO SPIN** option.

**WashSmart™** washer and **QuickSmart™** washer offers three spin speeds: **FAST** (1000 rpm), **MEDIUM** (700 rpm) and **SLOW** (300 rpm), plus an additional **NO SPIN** option.

- Fast
- Medium
- Slow
- ✳ No Spin



Increase or decrease your spin speed by touching the **SPIN SPEED** button. **NO SPIN** will pause the washer at the end of the rinse, allowing you to remove drip-dry items before you proceed the washer to its final spin. Touch **ⓘ**, select the **SPIN** cycle (change the spin speed if necessary, eg select **300** for delicate or creasable items) and touch **▶||**.

Some spin speeds are not available on some cycles for best clothes care (eg **DELICATE** cycle).

Your washer will optimise the spin speed according to the level of out of balance in the load.

## WASH OPTIONS

---

### Options

#### Soak (WashSmart™ Eco washer and WashSmart™ washer only)

Use the **SOAK** option to soak clothes during the agitation wash phase. Ensure items are colourfast before using **SOAK**.

When you select **SOAK** your washer will soak for a period of two hours before completing **RINSE** and **SPIN**. During **SOAK** your washer will agitate for a few seconds every minute.

Note: if the **SOAK** option is selected on a **QUICK** cycle, the soak time will be one hour only.

Soak is not available on the Wool cycle.

To exit **SOAK** early, touch ►|| and select **RINSE**. Change the spin speed if necessary (eg select **300** if washing delicate or creasable items) and touch ►||.

### Eco

Use the **ECO RINSE** option to save water. The **ECO RINSE** option uses a spray rinse which has been specially designed to use at least 25% less water than a traditional rinse. Use this option when you want to use less detergent and less water. However, if you have low water pressure or sensitive skin it is better to use a traditional rinse.

The **ECO RINSE** option has not been designed to be used with fabric softener, as it does not have a deep rinse to dispense the softener correctly. Fabric softener should not be used if this option is selected.

**ECO RINSE** is available on selected cycles only. If you try to select this option on other cycles your washer will skip over the option. The wash cycle will take slightly longer when the **ECO RINSE** option is selected.

There are some wash loads that may not suit being washed using the **ECO RINSE** option. For instance, loads that have a lot of sand or sawdust in them or garments where the colour still runs from them.

**DO NOT use your washer to soak items in bleach or sanitiser and if you've soaked items in a bucket, do not tip the contents of the bucket into your washer. The chemicals in these products are very corrosive to metal surfaces and can damage your washer. Rinse and wring items out thoroughly before placing them in your washer.**

## WASH OPTIONS

### Delay Start (not available on QuickSmart™ washer)

The **DELAY START** option can delay the start of the wash cycle between 5 minutes and 18 hours. This can be useful to time your washing to finish when you arrive home from work, or to start once you have finished in the shower.

1

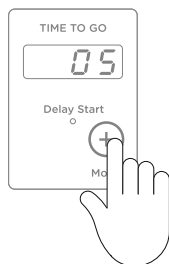

Simply touch **MORE +** to scroll through to your desired delayed start time, or to turn delay start off.

2



Touch **▶||** to confirm your selection and start the countdown. The display screen will show the time until the cycle is set to begin.

Avoid using **DELAY START** for damp, non-colourfast items as this may cause dye run to occur.

### Clothes care safeguards

To avoid accidentally damaging your clothes there are a few options that your washer will not accept. For example, you cannot select a **HOT** wash on the **DELICATE** and **WOOL** cycles.

## WASH OPTIONS

---

### Washing bulky items

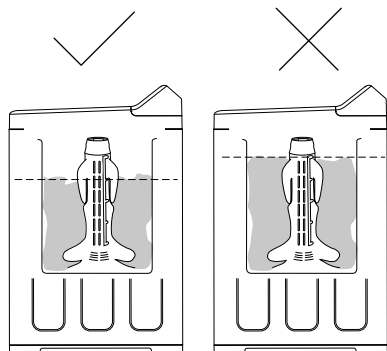

Forcing large items into the washer may result in them being damaged during washing. Make sure there is enough room in the washer for items to move when being washed.

Some items float up during the wash (e.g. duvets/ doonas, water-proof and water-resistant items and pillows). If they sit too high they may touch stationary parts of the washer during agitate or spin. To minimise the chance of this happening, ensure bulky items are pushed back down into the water after fill, and pushed down again to sit below the medium high water level mark on the agitator before **SPIN**. Select a **SPIN SPEED, 300**.

**To prevent an out of balance load or splash-over we recommend washing all bulky items, including water-proof and water-resistant items, on the DELICATE cycle.**

If you wish to re-spin the load at a faster speed make sure the load is sitting below the medium-high mark before spinning.

### Washing woollens

Many woollen items carry a 'Machine Washable' care claim. The fibres of these woollens have been treated to prevent felting when they are machine washed.

- Check the care label.
- Use a wool detergent.
- Use the specially designed **WOOL** cycle.
- To dry woollens lie them flat on a towel and pat into shape. Dry out of direct sunlight.

Most handcrafted garments are not made of machine washable wool and we recommend that you wash them by hand only. Hand washed woollens may be spun in your washer (select **SPIN SPEED, 700**).

Some wool underlays and sheepskin products can be washed in a washing machine but could produce excessive amounts of lint that may cause pump blockages.

# CUSTOMISING A WASH CYCLE

## To customise a cycle

You can program your CleanSmart™ washer to remember the wash options you prefer for each wash cycle. For instance, you may want to set the **REGULAR** cycle to default to a **WARM** wash or set **HEAVY** cycle to include a **SOAK**.

1



Touch 1

2



Touch and hold the wash cycle button you wish to customise, eg **REGULAR**, for 3 seconds.

3



You will hear 2 beeps and the screen will display **5 EE**.

4

- Auto
- High
- Medium
- ☀️ Low
- 1100
- ☀️ 700
- 300
- No Spin
- Soak
- ☀️ Eco Rinse
- Eco Active

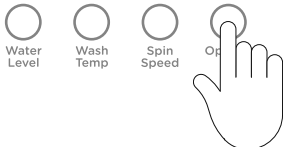

Select your preferred settings e.g. **LOW, COLD, 700, ECO RINSE**.

(WashSmart™ Eco washer displayed.)



## CUSTOMISING A WASH CYCLE

---

5



Touch the cycle button to store your settings. You will hear a long beep to confirm the changes have been saved.





6



Power off your washer.

To change your customised wash cycle simply repeat these steps.

## CHANGING PRE-SET OPTIONS

ICON	DEFAULT	CUSTOMISED FUNCTION
	Regular	Wash Temp
	Heavy	OOB Recovery
	Wool	EOC Beeps
	Delicate	Factory Reset

### Option Adjustment mode

After using your washer a number of times you may want to fine tune some of the options to suit your wash needs.

**There are a number of pre-set options, which can be altered:**



- ① The wash temperatures, including changing the **COLD** wash temperature to **CONTROLLED COLD**.
- ② The out of balance recovery routine.
- ③ The number of beeps at the end of the cycle.
- ④ Resetting to factory default settings.

### To enter Option Adjustment mode

To change or reset any of the options, repeat the below steps.



Turn machine on at the wall but do not touch ①.

Touch  and  together for 3 seconds. You will hear 3 quick beeps indicating you have entered Option Adjustment mode. The washer will show the default setting for the Cold wash temperature



Use buttons on the panel to make your changes to the pre-set options, eg Select **REGULAR** for Wash Temp.

(WashSmart™ Eco washer displayed.)



Touch ① to return to normal mode. Your washer will automatically remember your changes.

## CHANGING PRE-SET OPTIONS

### Adjusting your options

It displays when you first enter Option Adjustment Mode. Options you can change are accessible using the **HEAVY**, **DELICATE**, **WOOL** and **REGULAR** cycle Adjust the options, ie select the **REGULAR** cycle button to modify the wash temperature and **HEAVY** cycle button to change the out of balance (OOB) recovery process, and so on.

### WashSmart™ Eco washer and WashSmart™ washer



Enter Option Adjustment mode (refer to the 'Changing pre-set options' section).

Use the **DELAY START**, **MORE +** button on the panel to scroll through the available settings of your selected option, eg to increase or decrease the temperature of your warm wash temperature, or to change the number of beeps at the end of the cycle.

### QuickSmart™ washer



Enter Option Adjustment mode (refer to the 'Changing pre-set options' section).

Uses **WATER LEVEL** to scroll through the available settings.

# CHANGING PRE-SET OPTIONS

## Wash temperatures

All wash temperatures can be individually adjusted if you think they are too hot or too cold. The hot temperature will be the same as the hot water supply temperature.

To modify the wash temperature:



Enter the Option Adjustment mode, refer to 'Option Adjustment mode' for instructions.

Select the **REGULAR** cycle.

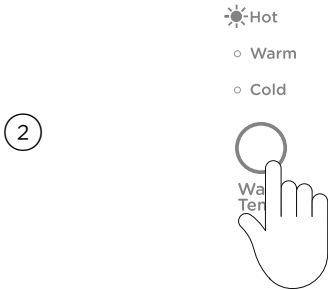

Select the wash temperature you want to adjust, eg **HOT**, by touching the **WASH TEMP** button. The digital display screen shows the current setting.

## WashSmart™ Eco washer and WashSmart™ washer



Touch the **MORE +** or **LESS -** to increase or decrease to the desired temperature. Each increment is equal to approximately 1°C.

## QuickSmart™ washer

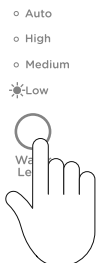

Touch the **WATER LEVEL** button to increase or decrease to the desired temperature. Each increment is equal to approximately 2°C.

## CHANGING PRE-SET OPTIONS

### Controlled Cold (not available on QuickSmart™ washer)

If your incoming cold water temperature is very low you will get a less effective wash. The **CONTROLLED COLD** option solves this problem by adding a small amount of hot water to raise the temperature of the wash to approximately 20°C.

To programme the Controlled Cold temperature option:

1



Enter the Option Adjustment mode, refer to the 'Option Adjustment mode' for instructions.

Select the **REGULAR** cycle.

2



Select **COLD** wash temperature by touching the **WASH TEMP** button (if not already selected).

3



The digital display shows the temperature adjustment possible. The default setting is **L AP**, which is the same temperature as the incoming water from the cylinder for cold water.

4

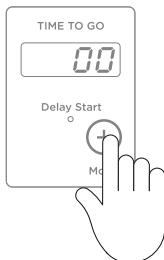

Touch the **MORE +** button until **00** is displayed. Your washer will now control the cold temperature to approximately 20°C.

Each of the remaining settings equals an approximate 1°C temperature increase or decrease from this point(excluding **L AP**).

## CHANGING PRE-SET OPTIONS

If you always use **COLD** or **CONTROLLED COLD** water, we recommend that a **WARM** or **HOT** wash be used regularly, eg every 5th wash should be at least a warm one to maintain the cleanliness of your washer.

### Out of balance recovery routine

When your washer is spinning it can sense if the wash load is out of balance. If an out of balance load is detected, the washer will stop and re-try spinning one more time. If it still senses an unbalanced load there are two options the washer can take.

#### Automatic recovery OFF (default setting)

Your washer will stop, beep, and show *o u t o f b a l* in three phases on the display screen. You must redistribute the load more evenly yourself and touch **▶||** to resume the cycle. Use this option if you wish to conserve water.

#### Automatic recovery ON

Your washer will try to automatically correct the out of balance load. It will fill with water and agitate to redistribute the load before trying to spin up again.

### To change the out of balance (OOB) recovery routine:



Enter Option Adjustment mode.

Select the **HEAVY** cycle.

### WashSmart™ Eco washer and WashSmart™ washer

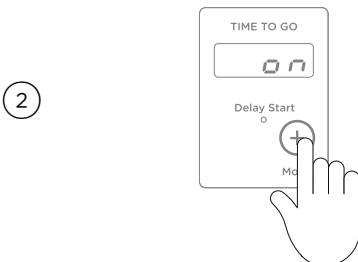

Touch the **+** button to turn automatic recovery *o n* or *o f f*.

## CHANGING PRE-SET OPTIONS

### QuickSmart™ washer

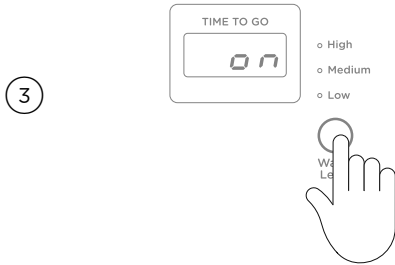

Touch the **WATER LEVEL** button to turn automatic recovery **00** or **0FF**.

### End of cycle beeps

The beeps signalling the end of the cycle can be increased or decreased. The default setting is five beeps.

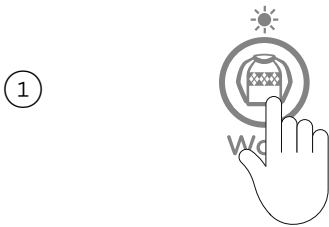

Enter Option Adjustment mode.

Select the **WOOL** cycle.

### WashSmart™ Eco washer and WashSmart™ washer

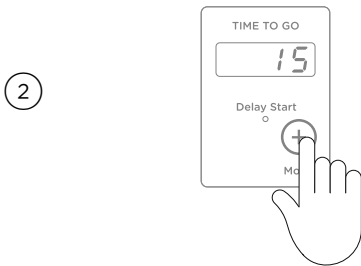

Touch the **MORE +** button to increase or decrease the number of beeps, or for no beeps to sound at the end of the cycle. Touch **ⓘ** to save the setting (if you wish to make no other changes)

## CHANGING PRE-SET OPTIONS

### QuickSmart™ washer

3

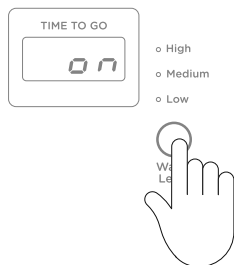

Touch the **WATER LEVEL** button to turn automatic recovery *on* or *off*.

### Factory reset

You can reset your washer to the settings it left the factory with:

1



Enter Option Adjustment mode, refer to the 'Option Adjustment mode' for instructions

Select the **DELICATE** cycle.

2



The display will show *r 5t*. Touch and hold **▶||** for 3 seconds to reset your washer to its factory settings.

This action will reset the washer to the default settings, exit Option Adjustment mode and restart the washer in normal operating mode.

3



Touch **1** to exit if you do not wish to reset your washer. To save changes and exit from the Option Adjustment mode at any time (ie to return to normal operating mode), touch **1**.



## CARING FOR YOUR WASHER

---

### When you have finished using your washer

- Turn off the taps to prevent the chance of flooding should a hose burst.
- Turn off the power at the wall.

### Cold water washing

If you always wash with cold water, we recommend that a **WARM** or **HOT** wash be used at regular intervals, e.g. every 5th wash should be at least a warm one.

### Cleaning your washer

Note: ensure the power is turned off at the wall before cleaning your washer.

- Clean the surfaces of your washer with a soft damp cloth only and wipe dry. Do not use scouring or spray cleaners as they can damage the paint, plastic and panel surfaces.
- Clean the fabric softener dispenser after each cycle using warm soapy water.
- To remove the agitator for cleaning, unscrew the nut down the centre of the agitator by turning anti-clockwise.
- The soft close lid is not designed to be removable for cleaning. Do not attempt to remove the lid.

**The agitator must be fully pushed onto the shaft when refitting. Tighten the nut firmly by hand. Ensure the agitator is not loose.**

### Cleaning the inside of your washer

If you use fabric softener or do regular cold water washing, it is important that you occasionally clean the inside of your washer.

Use commercial washing machine cleaners only. Ensure the cleaner used is compatible with your waste water system, i.e. safe for use if you have a septic tank. Follow the manufacturers instructions. We suggest not having any items in the washer during this cycle.

### WashSmart™ Eco washer and WashSmart™ washer

①



Fill your washer with hot water.

Touch ①, select the **ALLERGY** cycle.

## CARING FOR YOUR WASHER

2

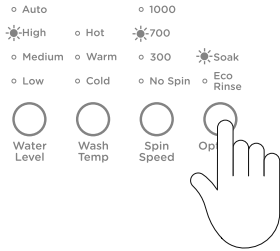

Select **HIGH** water level, **700** spin speed and **SOAK** option.

(WashSmart™ Eco washer displayed.)

3

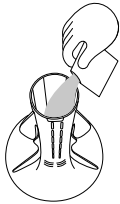

Add the washing machine cleaner directly down the centre of the agitator, follow the manufacturers instructions.

4



Touch ►► .

Let the washer complete the cycle.

5

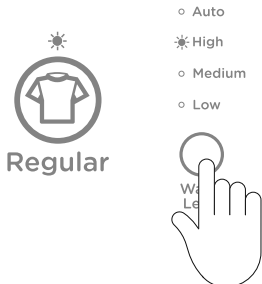

Select and run a **REGULAR** cycle on **HIGH** water level to remove any remaining detergent and scud.

## CARING FOR YOUR WASHER

### QuickSmart™ washer

1



Fill your washer with hot water.

Touch **1** , select the **REGULAR** cycle.

2

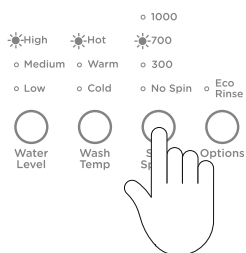

Select **HIGH** water level, **HOT** water temperature and **700** spin speed. Check that **ECO RINSE** is not selected.

3

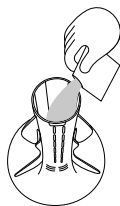

Add the washing machine cleaner directly down the centre of the agitator, follow the manufacturers instructions.

4



Touch **▶||** .

Let the washer complete the cycle.

## CARING FOR YOUR WASHER

---

5



- Auto
- ☀ High
- Medium
- Low



Select and run a **REGULAR** cycle on **HIGH** water level to remove any remaining detergent and scrud.

### Products that might damage your washer

- Concentrated bleaches, laundry pre-soakers/sanitisers, stain removers and hydrocarbon solvents (eg petrol and paint thinners) can cause damage to the surfaces eg control panel, and components of your washer.
- Be careful when washing garments stained with solvents as they are flammable. **DO NOT** put them in your dryer.
- Use of dyes in your washer may cause staining of the plastic components. The dye will not damage the washer but we suggest you thoroughly clean your washer afterwards. We do not recommend the use of dye strippers in your washer.

### Washer sounds and beeps

- Your washer may make sounds that you will not have heard from other clothes washers.
- While draining, your washer may give several low thuds. Your washer is checking that the water has drained before spinning.
- Your washer will beep if you have used **NO SPIN** and at the end of the cycle.
- If your washer is beeping continuously or giving a musical series of beeps, refer to the 'Before you call for service' section.

### Automatic lint system

Your washer has a self-cleaning lint system. The washer automatically separates the lint from the wash water, traps the lint between the inner and outer bowls and flushes it out at the end of the wash.

### Saving water, energy and the environment

Water efficient washing machines will save you money, but it is also worth thinking about energy use, recycling water and the environment. Some options to consider are:

- Turn the washer off at the wall when not in use.
- Turn off the taps when not in use.
- Wash full loads rather than several smaller loads.
- Use the **AUTO** water level option/function (where available).
- Use the **ECO ACTIVE™** wash and **ECO RINSE** option/functions (where available).
- Follow instructions on the detergent packet — do not overdose.
- Use concentrated detergent — it costs less per wash.
- Consider re-using the washing machines grey water on the garden or for flushing your toilet — more information can be found on government websites promoting energy and water saving.

## BEFORE YOU CALL FOR SERVICE

### User warnings

Your washer is capable of self diagnosis and may sound a series of beeps and display a notification or warning to inform you when there is a problem. In most cases you will be able to address the problem the washer is alerting you to. Check this chart before you call for service.

PROBLEM	DISPLAYED AS	WHAT TO DO
The washer is not getting any hot water.	n o h o t	Hot water supply is not hot enough to maintain the wash temperature you have selected. Select a lower wash temperature.
		Inlet hose filters may be blocked and should be cleaned or replaced.
		There may be a kink in the hose. Undo the hose to remove the kink, and reattach. Damaged hoses should be replaced.
		Ensure hot tap has been turned on.
The washer is not getting any cold water.	n o [ L d	Check inlet hoses are connected to the correct taps.
		Ensure cold tap has been turned on.
		Inlet hose filters may be blocked and should be cleaned or replaced.
		There may be a kink in the hose. Undo the hose to remove the kink, and reattach. Damaged hoses should be replaced.
		Check inlet hoses are connected to the correct taps.
		Cold water temperature exceeds recommended limits, refer to 'Water supply'.
The washer is not getting any water.	n o [ R P	The flow rate of the supply water is too slow. Refer to a registered plumber for advice.
		Ensure taps have been turned on.
		Inlet hose filters may be blocked and should be cleaned or replaced.
		There may be a kink in the hose. Undo the hose to remove the kink, and reattach. Damaged hoses should be replaced.
		The drain hose is too low or the drain hose is pushed into the standpipe too far and the water is siphoning out of the washer, refer to 'Draining'.
The flow rate of the supply water is too slow. Refer to a registered plumber for advice.		

## BEFORE YOU CALL FOR SERVICE

PROBLEM	DISPLAYED AS	WHAT TO DO
The washer is out of balance.	o u t o f b a l	<p>Wash load is out of balance. Ensure the washer is stationary. Manually redistribute the load.</p> <hr/> <p>Check the washer is level. Refer to 'Levelling instructions' for more information.</p>
The washer has too many suds.	S U d L o c	<p>The washer has a suds build-up (too much detergent may have been used for the amount of soil in the load). Wait for suds to dissolve (about 20 min). Rinse clothes using a deep rinse.</p> <hr/> <p>Check the standpipe height does not exceed 1200mm.</p> <hr/> <p>If the symptom persists, call your Fisher &amp; Paykel dealer or Fisher &amp; Paykel trained and supported service technician.</p>
The lid can't lock or the lid is open.	L i d    L i d L o c    o p n	<p>Make sure the lid is closed.</p> <hr/> <p>Touch ►  . Refer to 'Lid lock' for more information.</p> <hr/> <p>If the symptom persists call your Fisher &amp; Paykel dealer or Fisher &amp; Paykel trained and supported service technician.</p>
The washer is overloaded.	t o o F U L	<p>The washer is overloaded and can not agitate. Ensure the washer is stationary. Remove items until the remaining ones can move freely.</p> <hr/> <p>Select a higher water level.</p>
The washer has stopped.	P _ _ [ u t	<p>The power was cut to the washer. The washer will restart automatically. No action is required.</p>
The washer has stopped.	A d r	<p>The ►   or Ⓛ button was touched and the washer was inactive for three minutes. The washer will automatically drain to a safe level. Touch any button to stop autodrain then touch ►   to resume the wash cycle.</p>
The washer is on but the display is blank.		<p>The washer was unattended without starting a cycle for a period of time. Touch Ⓛ to activate.</p>

\*The beeps are the same sound your washer makes when you turn it on at the wall.

## FAULT CODES

---

When a continuous series of beeps is sounded, all the lights turn off on the control panel and a number appears on the display, a fault has occurred. The washer will automatically enter this mode if a fault occurs. The fault code will be displayed as a number on the digital display. To stop the sound, touch any button and perform the following steps:

- ① Turn your washer off at the power point.
- ② Wait one minute and turn it back on.
- ③ Remove your wash load.
- ④ Perform a **RINSE** cycle.
- ⑤ If the washer will still not work you will be required to call a Fisher & Paykel trained and supported service technician to arrange service (refer to the 'Customer Care' section). Record the fault code number displayed and the serial number of your washer (located on the rear of the washer) before calling. The fault code will indicate to the service technician what the problem could potentially be.

If a fault code is being displayed, you can still turn your washer off by touching ① .

## TROUBLESHOOTING

The following is a list of problems you may encounter when using this appliance and some suggestions that may help to correct the problem. If you still have problems, please contact your Fisher & Paykel trained and supported service technician or our Customer Care Centre.

### Solving operating problems

PROBLEM	POSSIBLE CAUSES	WHAT TO DO
Washer not turning on.	Power not switched on at the wall.	Switch the power off at the wall and wait 60 seconds before turning power on again.
	Household power supply not working.	Try plugging in another electrical appliance.
	Keylock may be activated.	Try holding down the <b>ⓘ</b> button for two seconds, refer to 'Keylock'.
Washer not filling with water when <b>▶</b> II touched.	Inlet taps not turned on.	Check that both the hot and cold taps are turned on.
	Blocked inlet hose filters.	Clear blockages from inlet hose filters.
	'Delay Start' is set.	Refer to 'Wash options—Delay start' for more information about the <b>DELAY START</b> function.
Washer is filling continuously.	Drain hose is not installed correctly.	Ensure drain hose is located in standpipe or tub.  Ensure standpipe is at least 850mm high but no more than 1200mm high.
	Washer could be siphoning.	To prevent siphoning ensure the drain hose does not extend more than 20mm from the end of the hose guide, refer to 'Draining'.
Washer is not spinning properly.	The load could be out of balance.	Pause washer and manually redistribute the load.
		Check the washer is level and does not rock in any direction, refer to 'Levelling instructions'.
		Check the washer does not have suds build up.



## TROUBLESHOOTING

### Solving operating problems

PROBLEM	POSSIBLE CAUSES	WHAT TO DO
Spin speed sounds slower than normal.	Clothes are unevenly distributed in the bowl.	Washer has compensated by lowering the spin speed.
	The outer wash bowl may still be hot from being filled with hot water.	The washer has slowed the spin speed as a protective measure.
Washer is continually going out of balance.	Washer may not be level.	Check the washer is level and does not rock in any direction, refer to 'Levelling instructions'.
	Too much water for the load	Ensure an appropriate water level is selected for the load size (or select <b>AUTO</b> water level).  Refer to 'Out of balance recovery routine' for more information to change the out of balance recovery mode.
Too much or too little water when filling on auto water level.	The washer needs to determine the correct water level for the load.	Refer to the 'Wash options' section.
	Some loads do not suit <b>AUTO</b> water level, eg pillows.	Manually select the most appropriate water level for the load.
Washer is making noises.	Banging.	Load is out of balance. Touch <b>▶  </b> and redistribute the load.
	Other noises.	Refer to the 'Caring for your washer' section.
Small puddle coming from under the washer.	The water level is too high for the amount of clothes and has caused excessive splashing.	Select a lower water level, refer to 'Water Level'.
	Large bulky garments (eg pillows, duvet) can cause splashing.	Wash on the <b>DELICATE</b> cycle, refer to 'Washing bulky items'.

## TROUBLESHOOTING

### Solving wash problems

PROBLEM	POSSIBLE CAUSES	WHAT TO DO
<b>Creasing.</b>	Overloading of the washer.	Try reducing load size.
	Inappropriate cycle selection.	Choose <b>DELICATE</b> cycle as this cycle has been designed to minimise creasing.
	Spin speed too high.	Try selecting a lower spin speed.  Do not leave wet clothes to sit in the washer or laundry basket.
	Wash temperature too high for items.	Try selecting a lower wash temperature.  Sort your load so that items of similar weight are washed together.
<b>Poor soil removal.</b>	Wash cycle selected not suited to soil level in load.	Are you using the most appropriate wash cycle for the amount of dirt?
	Warm wash water is too cold.	Refer to 'Wash temperatures'.
	Not enough detergent for load size or amount of soil.	Refer to the detergent package for the manufacturers recommended dosage.
	White clothes are better washed separately.	Separate light and heavily soiled items, as clothes can pick up soil from dirty wash water.
	Cold water wash is too cold.	Refer to 'Wash temperatures'.
	Wash temperature not suited to soil type in load.	Blood and mud are better washed in cold water, while oily soils are better washed in warmer water.
	Overloading the washer.	Try reducing your load size.
	A full load of items of the same size eg sheets may not wash as well.	Loads made up of articles of varying sizes will wash better.
Hard water requires more detergent than soft water.	If you have hard water, try adding more detergent.	
<b>Tangling.</b>	Washing with too much water (underloading) can cause the clothes to tangle around one another.	Select an appropriate water level for the load size, or select <b>AUTO</b> water level, refer to 'Wash options'.
	Items wrapped around the agitator when loading.	Place items, especially sheets, in the bowl as loose parcels.

## TROUBLESHOOTING

### Solving wash problems

PROBLEM	POSSIBLE CAUSES	WHAT TO DO
<b>Linting.</b>	Some items in load more likely to release or pick up lint.	Wash lint givers (eg towels, flannelette sheets) separately from lint collectors (eg synthetic fabrics).
	Overloading the washer.	Try reducing your load size.
	Not enough detergent to hold the lint in suspension.	Try using more detergent.
	Overdrying in a dryer can cause a build-up of static electricity in synthetic fabrics and cause them to attract lint.	Try not to over dry items when using your dryer.
<b>Detergent residue.</b>	Overloading the washer.	Try reducing your load size.
	Did you use the recommended amount of detergent?	Try using less detergent.
	Some detergents need to be pre dissolved before being added to the washer.	Check the detergent instructions.
	Cold ambient temperatures, cold washes and/or short agitation times may not allow the detergent to dissolve properly.	Try pre-dissolving the detergent before adding it to the washer.
<b>Black or grey marks on clothes.</b>	A build up caused by the interaction of fabric softener and detergent can flake off and mark clothes.	Refer to 'Fabric Softener' and 'Caring for your washer'.
	Insufficient detergent for the amount of soil on the clothes, can result in grey marks on clothes.	Make sure you are using enough detergent for the amount of dirt in your wash load, refer to 'Detergent'.
<b>Dye transfer.</b>	Washing dark coloured and light coloured items together.	Remember to separate whites and colours.
	Keep wet or damp dark coloured and light coloured items separate.	Wash and dry non-colourfast clothes separately.  Non-colourfast clothes left sitting in a washer or laundry basket can transfer dye onto other clothes.

## MANUFACTURER'S WARRANTY

---

For New Zealand and Australia only. You automatically receive a two-year Manufacturer's Warranty with the purchase of this clothes washer covering parts and labour for servicing within the country of purchase.

### **Fisher & Paykel undertakes to:**

Repair or, at its option, replace without cost to the owner either for material or labour any part of the product, the serial number of which appears on the product, which is found to be defective within two years of the date of purchase.

You also receive an additional eight-year parts only Manufacturer's Warranty on your Direct Drive motor. This additional eight-year Manufacturer's Warranty commences on the day following the expiry of the two-year Manufacturer's Warranty and excludes the motor controller and labour. Fisher & Paykel will repair (as to parts) or, at its option, replace any Direct Drive motor (but not the motor controller) which is found to be defective within this additional Manufacturer's Warranty period. You will be responsible for any labour costs.

Note: These Manufacturer's Warranties are an extra benefit and do not affect your legal rights.

### **These Manufacturer's Warranties DO NOT cover**

- Ⓐ Service calls which are not related to any defect in the product. The cost of a service call will be charged if the problem is not found to be a product fault. For example:
  - ① Correcting the installation, eg removal of bottom packer and transit bolts (front loading washers), levelling the washer, adjustment of the drain to correct siphoning, noises, crossed, kinked or leaking inlet hose connections, turning on water, noises caused by the waterhammer or power supplies.
  - ② Providing instruction on use of the product or changing the set-up of the product, eg instruction on correct use of detergents and fabric softeners.
  - ③ Replacing fuses in, or correcting house wiring or correcting house plumbing, eg unblocking drains.
  - ④ Correcting fault(s) caused by the user.
  - ⑤ Noise or vibration that is considered normal, eg spin sounds, user warning beeps.
  - ⑥ Correcting damage caused by pests, eg rats, cockroaches, etc.
  - ⑦ Water on the floor due to incorrect loading or excessive suds.
  - ⑧ Blocked pumps, removal of foreign objects/substances from the washer, including the pump and inlet hose filters, eg bra wires, bread tags, nails, grit, scrud, etc.
  - ⑨ Correcting corrosion or discolouration due to chemical attack.
- Ⓑ Defects caused by factors other than:
  - ① Normal domestic use; or
  - ② Use in accordance with the product's user guide.
- Ⓒ Defects to the product caused by accident, neglect, misuse or 'act of God'.
- Ⓓ The cost of repairs carried out other than by a Fisher & Paykel trained and supported service technician or the cost of correcting such repairs.
- Ⓔ Normal recommended maintenance as set out in the product's user guide.
- Ⓕ Repairs when the appliance has been dismantled, repaired or serviced by other than a Fisher & Paykel trained and supported service technician or the selling dealer.
- Ⓖ Pick-up and delivery.

## MANUFACTURER'S WARRANTY

---

- Ⓜ Transportation or travelling costs involved in the repair when the product is installed outside the Fisher & Paykel trained and supported service technician's normal service area.

Nothing in this Manufacturer's Warranty is intended to, nor limits, any rights you may have under law to recover the costs of inspecting or returning the goods to us.

This product has been designed for use in a normal domestic (residential) environment. This product is not designed for any commercial use (whatsoever). Any commercial use by a customer will affect this product's Manufacturer's Warranty.

Service under these Manufacturer's Warranties must be provided by a Fisher & Paykel trained and supported service technician 'Customer care'. Such service shall be provided during normal business hours. This Manufacturer's Warranty certificate should be shown when making any claim.

### **For Australian customers**

This Manufacturer's Warranty is an extra benefit and does not affect your legal rights. Our goods come with guarantees that cannot be excluded under the Australian Consumer Law. You are entitled to a replacement or refund for a major failure and compensation for any other reasonably foreseeable loss or damage. You are also entitled to have the goods repaired or replaced if the goods fail to be of acceptable quality and the failure does not amount to a major failure.

**Keep this user guide in a safe place.**

## CUSTOMER CARE

---

### **Before you call for service or assistance:**

Check our website, [fisherpaykel.com](http://fisherpaykel.com), for 'Product Help' to see the latest updates, hints and tips, and information about your product.

We recommend that you also refer to your user guide to ensure:

- ① Your product is correctly installed.
- ② You are familiar with its normal operation.
- ③ You have read the 'Before you call for service', 'Fault codes' and 'Troubleshooting' at the back of the book.

If after checking these points you still need assistance or parts, you can go online to our website and book a service with your nearest Fisher & Paykel trained and supported service technician. Our Customer Care team is also available to offer you assistance.

### **In New Zealand if you need service or assistance:**

Go online to our website and book a service or call the Fisher & Paykel Customer Care Centre and talk to one of our Customer Care Consultants.

**Toll Free:** 0800 FP CARE or 0800 372 273

**Email:** [customer.care@fisherpaykel.com](mailto:customer.care@fisherpaykel.com)

**Website:** [fisherpaykel.com](http://fisherpaykel.com)

**Postal address:** Fisher & Paykel Appliances Ltd, PO Box 58546, Botany, Auckland 2163

Fisher & Paykel has a network of Fisher & Paykel trained and supported service technicians who can carry out any service necessary on your appliance. Visit our website and book a service with a Fisher & Paykel trained and supported service technician in your area.

### **In Australia if you need service or assistance:**

Go online to our website and book a service or call the Fisher & Paykel Customer Care Centre and talk to one of our Customer Care Consultants.

**Toll Free:** 1300 650 590

**Email:** [customer.care@fisherpaykel.com](mailto:customer.care@fisherpaykel.com)

**Website:** [fisherpaykel.com](http://fisherpaykel.com)

**Postal address:** Fisher & Paykel Appliances Australia Pty Ltd, PO Box 798, Cleveland QLD 4163

### **In Singapore if you need service or assistance:**

Call the Fisher & Paykel Customer Care Centre and talk to one of our Customer Care Consultants.

**Phone:** 6741 0777

**Fax:** 6547 0123

**Website:** [www.fisherpaykel.com](http://www.fisherpaykel.com)

**Postal address:** 150 Ubi Avenue 4, Sunlight Building #03-01A, Singapore 408825

## CUSTOMER CARE

---

Fisher & Paykel has a network of Fisher & Paykel trained and supported service technicians who can carry out any service necessary on your appliance. Visit our website and book a service with a Fisher & Paykel trained and supported service technician in your area.

**If you call, write to or contact us via our website, please provide your name and address, model number, serial number, date of purchase and a complete description of the problem. This information is needed in order to better respond to your request for assistance.**

**Product details can be found on the rear of the washing machine.**

### Registration

Register your product with us so we can provide you with the best service possible. To register your product visit our website: [fisherpaykel.com](http://fisherpaykel.com)

Complete and keep for safe reference:

Model	_____
Serial No.	_____
Purchase Date	_____
Purchaser	_____
Dealer	_____
Suburb	_____
Town	_____
Country	_____

**FISHERPAYKEL.COM**

© Fisher & Paykel Appliances 2021. All rights reserved.

The models shown in this guide may not be available in all markets  
and are subject to change at any time.

The product specifications in this guide apply to the specific products and  
models described at the date of issue. Under our policy of continuous product  
improvement, these specifications may change at any time.

For current details about model and specification availability in your country,  
please go to our website or contact your local Fisher & Paykel dealer.

**429598C 06.21**