

FISHER & PAYKEL

FREESTANDING RANGE

**OR30SCG6, OR30SDG6, OR36SCG6 &
OR36SDG6 models**

USER GUIDE

US CA



WARNING!

If the information in this manual is not followed exactly, a fire or explosion may result causing property damage, personal injury or death.

Do not store or use gasoline or other flammable vapors and liquids in the vicinity of this or any other appliance.

NEVER use this appliance as a space heater to heat or warm the room. Doing so may result in carbon monoxide poisoning and overheating of the appliance.

WHAT TO DO IF YOU SMELL GAS

- **Do not try to light any appliance.**
- **Do not touch any electrical switch.**
- **Do not use any phone in your building.**
- **Immediately call your gas supplier from a neighbor's phone. Follow the gas supplier's instructions.**
- **If you cannot reach your gas supplier, call the fire department.**

Installation and service must be performed by a qualified installer, service agency or the gas supplier.

CONTENTS

Safety and warnings	4
Introduction	8
First use	10
Cooking guide	16
Oven functions	18
Cooking Charts	22
Setting the timer	28
Auto cook	30
Locking the oven controls	34
User preference settings	36
Sabbath mode	38
Using your gas cooktop	40
Cooking guidelines and cookware	43
Using the Warming drawer	45
Care and cleaning	46
Using the Self Clean function	57
Troubleshooting	60
Alert codes	65
Warranty and service	67

Registration

To register your product visit our website: fisherpaykel.com/register

SAFETY AND WARNINGS

To reduce the risk of fire, electrical shock, injury to persons, or damage when using the appliance, follow the important safety instructions listed below:

WARNING!



Electrical Shock Hazard

Before removing a faulty oven light bulb, make sure you turn the power to the range off at the main fuse or circuit breaker panel. If you don't know how to do this, contact an electrician.

This appliance is equipped with a three-prong or four-prong grounding plug for your protection against shock hazard and should be plugged directly into a properly grounded power outlet. Do not under any circumstances cut or remove the grounding prong from this plug. Failure to follow this advice may result in death or electrical shock.

WARNING!



Tipping Hazard

A child or adult can tip the range and be killed. Check installation of anti-tip device per installation instructions. Check engagement of anti-tip device if range is moved per installation instructions.

Failure to follow these instructions can result in death or serious burns to children and adults

WARNING!



Fire Hazard

Never use your appliance for warming or heating the room.

Persons could be injured or a fire could start.

Keep the area around the appliance free from combustible materials (eg wall coverings, curtains, drapes), gasoline and other flammable vapors and liquids.

Do not let cooking grease or other flammable materials accumulate in, or, or near the appliance.

Do not hang any articles (eg dish towels) off the oven handle.

Some fabrics may ignite or melt from the heat.

Never leave the cooktop burners unattended when in use - boilover causes smoking and greasy spillovers that may ignite.

Be sure all the controls are turned off and the appliance is cool before using any type of aerosol cleaner on or around the appliance.

Chemicals in such cleaners could, in the presence of heat, ignite or cause metal parts to corrode.

Failure to follow this advice may result in death or serious injury.

SAFETY AND WARNINGS

WARNING!



Explosion Hazard

If you smell gas, do not use the appliance. Open a window or door to let the gas escape, then follow the instructions on the inside front cover of this manual.

Do not use water on grease fires. A violent steam explosion may result. Turn all burners off, then smother fire or flame or use dry chemical or foam-type extinguisher.

Do not heat unopened food containers such as cans - build-up of pressure may cause container to burst and result in injury. Failure to follow this advice may result in injury or death.

WARNING!



Poisoning Hazard

Never cover any slots, holes or passages in the oven bottom or cover an entire rack or the oven floor with materials such as aluminum foil.

Doing so blocks airflow through the oven and may cause carbon monoxide poisoning. Aluminum foil linings may also trap heat, causing a fire hazard.

Clean the appliance with caution. If a wet sponge or cloth is used to wipe spills on a hot cooking area, be careful to avoid steam burn. Some cleaners can produce noxious fumes if applied to a hot surface. Follow the directions of the cleaner manufacturer.

Never use this appliance as a space heater to heat or warm the room. Doing so may result in carbon monoxide poisoning and overheating of the appliance.

Failure to follow this advice may result in poisoning or death.

WARNING!



Hot Surface Hazard

Accessible parts may become hot during use.

Do not touch burners, areas near burners, heating elements or interior surfaces of oven - these may be hot enough to cause burns even though they are dark in color. During and after use, do not touch, or let clothing or other flammable materials contact these parts and surfaces until they have had sufficient time to cool. Other parts and surfaces of the appliance may become hot enough to cause burns among these areas are the grates, back trim and oven vents at the back of the cooktop, front edge, surfaces adjacent to the cooktop, and the oven door.

Use only dry potholders - moist or damp potholders on hot surfaces may result in burns from steam. Do not let potholder touch hot heating elements. Do not use a towel or other bulky cloth.

Let hot grease cool before attempting to handle it.

During self-cleaning, the oven reaches higher temperatures than it does for cooking. Under such conditions, the surfaces may get hotter than usual. Children should be kept away.

Failure to follow this advice may result in serious injury.

IMPORTANT SAFETY INSTRUCTIONS!

- Read all the instructions before using the appliance. Use the appliance only for its intended purpose as described in these instructions.
- Proper installation – be sure your appliance is properly installed and grounded by a qualified technician. A risk of tip-over exists when the appliance is not installed in accordance with the installation instructions.
- Do not operate the appliance if it is damaged or not working properly. If you received a damaged product, contact your dealer or installer immediately.
- Be sure to have the installer show you where and how to turn off the power supply to the range (ie location of the main fuse or circuit breaker panel) and where and how to turn off the gas supply to the range in an emergency.
- Do not leave children alone – children should not be left alone or unattended in the area where the appliance is in use. They should never be allowed to play with the appliance or to sit or stand on any part of the appliance.
- Caution – for safety reasons, do not store items of interest to children in cabinets above a range or at the back of the range – children climbing on the range to reach items could be seriously injured.
- Wear proper apparel – loose-fitting or hanging garments should never be worn while using the appliance.
- User servicing – do not repair or replace any part of the appliance unless specifically recommended in the manual. All other servicing should be referred to a qualified technician. Technicians must disconnect the appliance from the power supply before any servicing.
- Storage in or on appliance – flammable materials should not be stored in an oven or near the cooktop.
- Use care when opening the oven door – let hot air or steam escape before removing or replacing food.
- Keep oven vent ducts unobstructed.
- Keep rugs and mats well clear of the base of the range.
- Placement of oven shelves – always position shelves in the desired location while the oven is cool (before preheating). If a shelf must be removed while the oven is hot, do not let oven mitts or potholder contact the base of the oven or hot heating elements in the oven.
- Do not clean the oven gasket or use any oven-cleaning products on it. It is essential for a good seal, which ensures that the oven operates efficiently. Care should be taken not to rub, damage or move it.
- Do not use oven cleaners, harsh/abrasive cleaning agents, waxes, or polishes in a self-cleaning oven. No commercial oven cleaner, oven liner, or protective coating of any kind should be used in or around any part of a self-cleaning oven.
- Do not use harsh/abrasive cleaners, scourers or sharp metal scrapers to clean the oven door glass since they scratch the surface, which may result in the glass shattering.
- Do not sit or stand on the oven door or place any heavy objects on it – doing so may result in personal injury.
- Be careful when reaching for items stored in cabinets above the appliance.

IMPORTANT SAFETY INSTRUCTIONS!

- **Safe food handling:** leave food in the oven for as short a time as possible before and after cooking. This is to avoid contamination by organisms which may cause food poisoning. Take particular care during warmer weather.
- Clean only the parts listed in this manual.
- Do not use a steam cleaner to clean any part of the appliance.
- Do not obstruct the flow of combustion and ventilation air to the appliance.
- The oven of your range cannot be used in the event of a power failure. Do not attempt to operate these during power failure.
- Do not use aluminum foil to line any part of the oven, warming drawer or cooktop. This will cause heat to be trapped underneath it. This trapped heat can upset the cooking performance and damage the finish of the oven or cooktop parts.
- Do not place any dishes, trays, water or ice directly on the oven floor during cooking, as doing so will irreversibly damage the porcelain enamel finish.
- For safety reasons, the cooktop burner flame size should be adjusted so it does not extend beyond the edge of the cookware.
- Use cookware of the appropriate size and construction for the type of cooking. This appliance is equipped with burners of different sizes. Cookware must be matched to the size of the burner. Select utensils with flat bottoms large enough to cover the burner flames. The use of undersize utensils will expose a portion of the burner flames to direct contact and may result in ignition of clothing. Proper relationships of utensil to burner will also improve efficiency.
- Protective liners - do not use aluminum foil to line grease drip-pans or oven bottoms.
- Glazed cooking utensils - only certain types of glass, glass/ceramic, ceramic, earthenware, or other glazed utensils are suitable for cooktop service without breaking due to the sudden change in temperature.
- Utensil handles should be turned inward and not extend over adjacent cooktop burners - to reduce the risk of burns, ignition of flammable materials, and spillage due to unintentional contact with the utensil, the handle of a utensil should be positioned so that it is turned inward, and does not extend over adjacent cooktop burners.
- **WARNING:** This product contains a chemical known to the State of California to cause cancer, birth defects or other reproductive harm. To reduce the risk from such chemicals, make sure this appliance is installed, operated, and maintained according to the manufacturer's instructions.

INTRODUCTION

30" MODELS

Features may vary

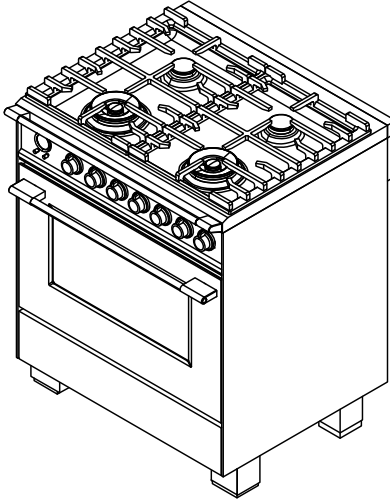

OR30SCG6
OR30SDG6

36" MODELS

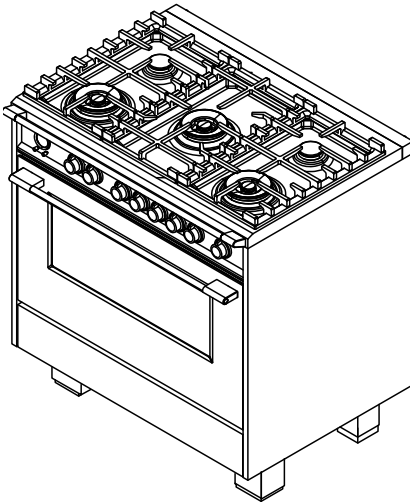

OR36SCG6
OR36SDG6

INTRODUCTION

Before you start

- ① Make sure that the anti-tip bracket at the right rear of the range has been properly installed.
- ② Make sure that the installer has completed the 'Final checklist' in the Installation instructions.
- ③ Read this guide, taking special note of the 'Safety and warnings' section.
- ④ Remove all accessories and packaging from the oven and cooktop. Recycle items that you can. If any adhesive residue is left on surfaces, remove this using dishwashing liquid on a soft cloth. Do not use any harsh or abrasive cleaners.
- ⑤ Make sure you follow the instructions under 'First use' before using your range for cooking.

Overview

Features may vary.

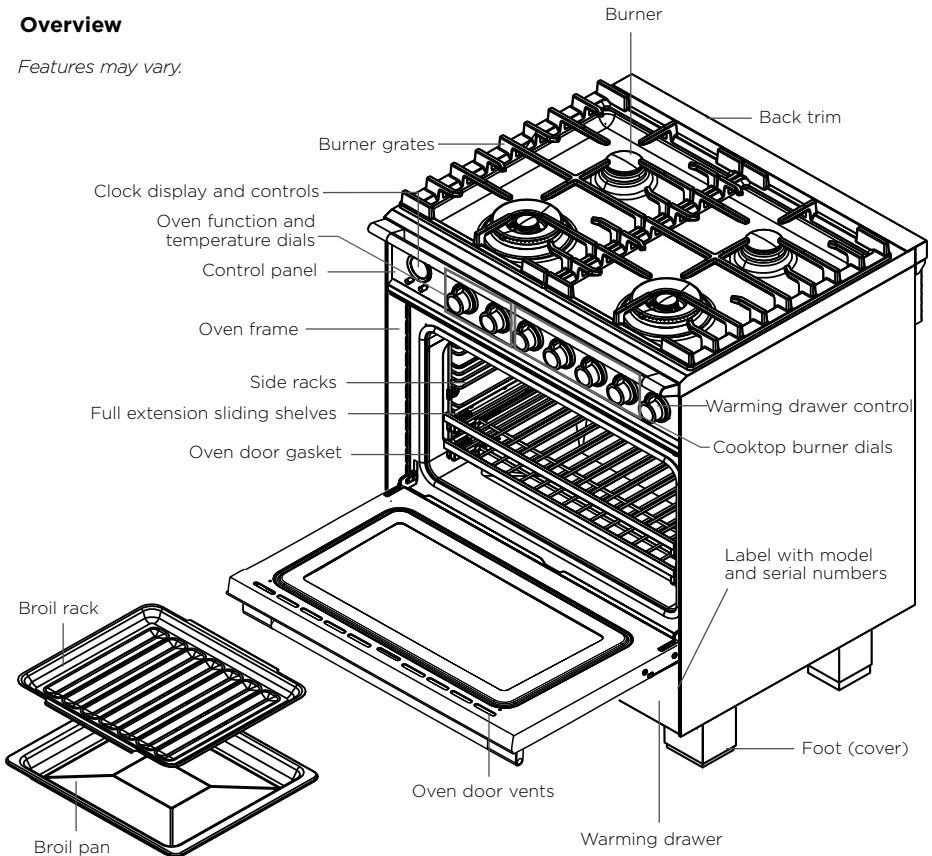

FIRST USE

Control panel layout

Dials may vary

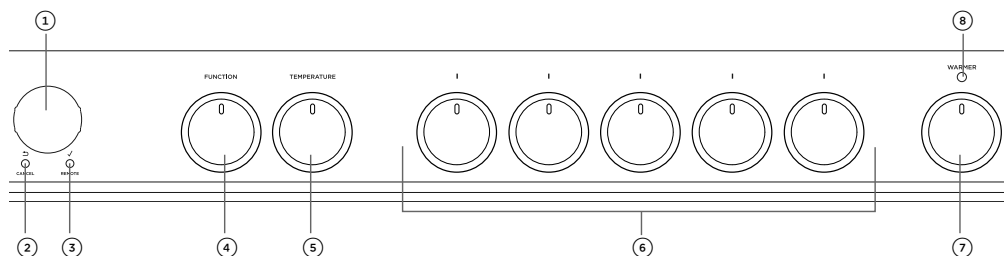

- ① Oven display
- ② Cancel/back button
- ③ Select/Scroll control
- ④ Function dial
- ⑤ Temperature dial
- ⑥ Cooktop control dials
- ⑦ Warming drawer dial
- ⑧ Warming drawer indicator

Clock display and controls



Timer (see 'Setting the timer')



Remote Mode
(Not available on this product)



Auto cook
(see 'Auto cook')



Wireless connection
(Not available on this product)



Lock
(see 'Locking the oven controls')

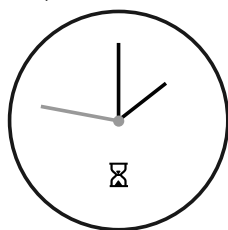

CANCEL



REMOTE

Cancel/back button

- Press to go back
- Press and hold to cancel

Select

- Press to accept or to enter a menu
(Remote mode not available on this product)

Scroll control

- Turn clockwise or counterclockwise to scroll through menu options

FIRST USE

Setting the clock

When your oven is first turned on, or after a power cut, the display will flash. You will need to set the clock in order to use the oven.

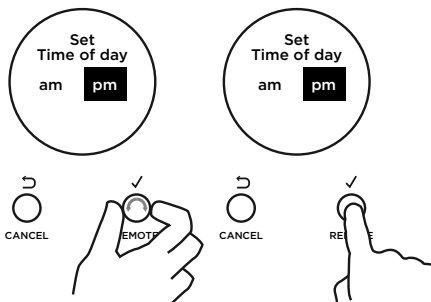
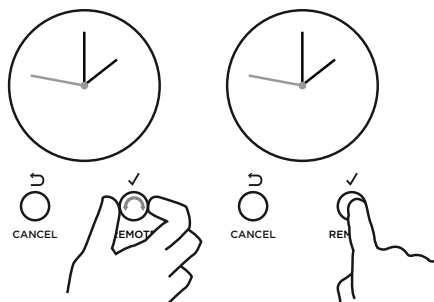

- ① Scroll to choose your preferred clock display.
Select between:
 - Analog
 - 24-hr digital
 - 12-hr digital
 - Display off**
- ② Press ✓ to confirm.

- ②Ⓐ If you have set analog or 12-hr digital display:
 - Scroll to select am or pm.
 - Press ✓ to confirm.

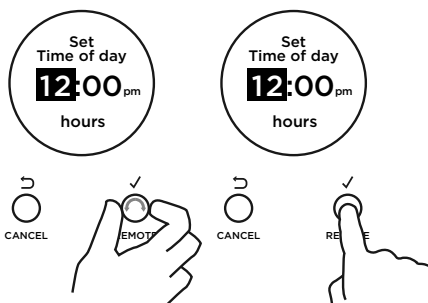
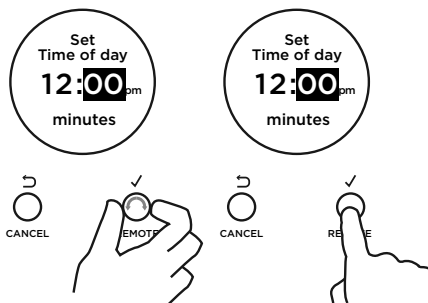

- ③ Scroll to set the minutes.
 - Scroll to select am or pm.
 - Press ✓ to confirm.

- ④ Scroll to set the hours.
 - Press ✓ to confirm.

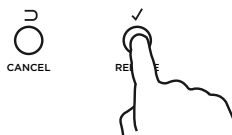

- ⑤ Press ✓ to confirm the time is correctly set.
 - The clock is now set and you can begin using your oven.

** With this option saved, you can still use the oven and timer, however the display will remain unlit. You cannot use any automatic cooking functions when this option is selected. To quit this option and enable the display, press and hold CANCEL.

FIRST USE

Positioning the shelves

- Shelf positions are numbered from the bottom.
- Position the shelves you will need before turning the oven on.
- For advice on which shelf position to use, see sections 'Oven functions', 'Oven cooking guidelines', and 'Cooking charts'.

IMPORTANT!

Always position the oven shelves before turning the oven on. Remove any unused shelves and baking utensils from the oven.

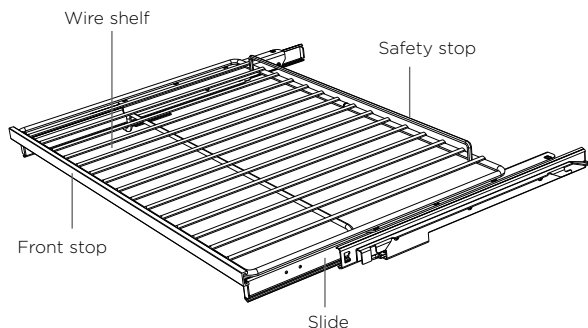
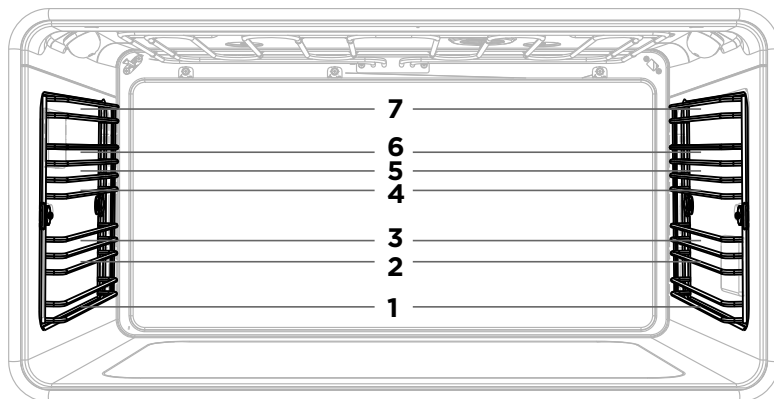

Full extension sliding shelves

- The wire shelves and slides are built together as one unit.
- When positioned correctly, the slides will prevent the wire shelves from tilting when pulled forward.
- Beware: these shelves are heavy.

FIRST USE

To insert the shelves

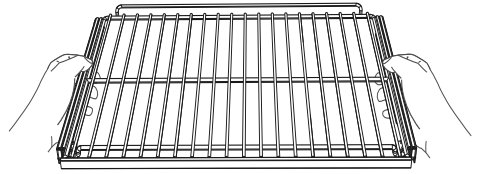
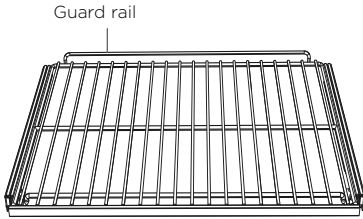

- ① Make sure the guard rail is at the back, facing up and the slides are not extended.
- ② Hold the shelf firmly with both hands, making sure you grip the wire shelf too to stop it sliding forward.

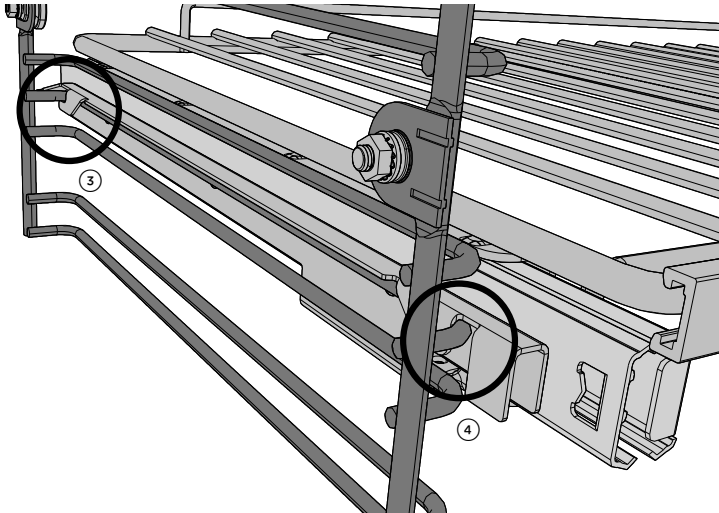

- ③ Hook the rear tags over the wires of the desired shelf position on both side racks.
- ④ Push the shelf all the way into the oven, ensuring the front and rear tags either side are securely locked behind the side rack wires.

To remove the shelves

- ① **Wait for the oven to cool down completely.**
- ② Hold the shelf firmly with both hands, making sure you grip the wire shelf too to stop it sliding forward.
- ③ Pull the shelf forward about $\frac{3}{4}$ of the way.
- ④ Lift the rear of the shelf slightly so that the tags clear the side rack wires, then remove.

FIRST USE

Conditioning the oven

It is important to condition your oven before using it for cooking and baking. Conditioning will burn off any manufacturing residues and ensure that you get the best results right from the start.

Before you start:

- Make sure you have removed all packaging and any cable ties used to secure the shelving during transit.
- Make sure all shelves are fitted in the oven.
- Make sure all oven control dials are turned to O (OFF).

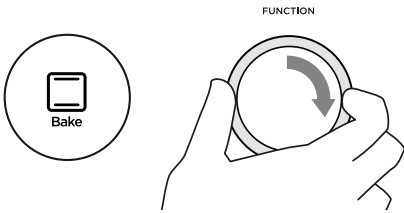

- ① Select the Bake function.
 - The halo will glow white.

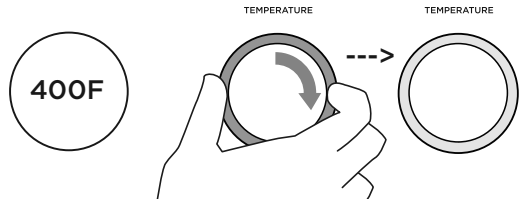

- ② Set the temperature to 400°F for 30 minutes.
 - The halo will glow red while the oven is heating up.
 - The actual temp will show on the screen.
 - When the oven has heated a tone will sound and the halo will turn white.

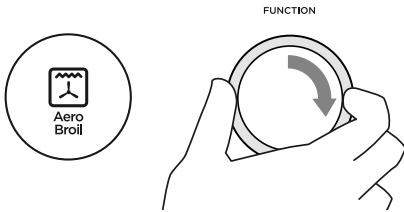

- ③ After 30 minutes, select the Aero Broil function.
 - Heat at 400°F for 10 minutes.

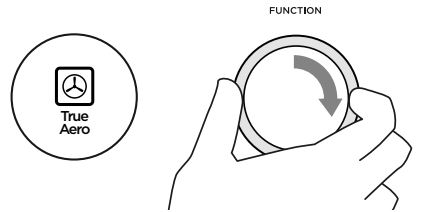

- ④ After 10 minutes, select the True Aero function.
 - Heat at 400°F for 20 minutes.

FIRST USE

FUNCTION

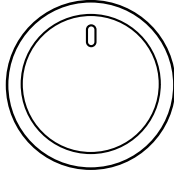

TEMPERATURE

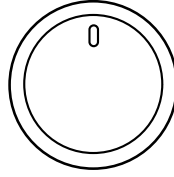

- ⑤ After 20 minutes turn both the function and temperature dials to 0 (OFF). The halos will go out.
- There will be a distinctive smell and a small amount of smoke during the conditioning process as manufacturing residue is burnt off. This is normal, but make sure the kitchen is well ventilated during the conditioning.
 - Once cooled, wipe out the oven and warmer drawer with a damp cloth and mild detergent, and dry thoroughly.

Conditioning the warming drawer

IMPORTANT!

Make sure the drawer is empty and all packaging has been removed.

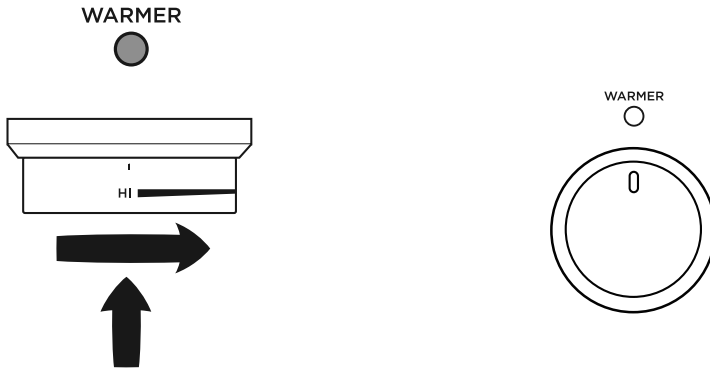

- ① Push in the warmer dial and turn clockwise to HI.
- The indicator will glow red.
 - Heat on HI for 2 hours.
- ② After 2 hours turn warmer dial to 0 (OFF).
- The indicator will go out.
- There will be a distinctive smell and a small amount of smoke during the conditioning process as manufacturing residue is burnt off. This is normal, but make sure the kitchen is well ventilated during the conditioning.
 - Once cooled, wipe out the drawer with a damp cloth and mild detergent, and dry thoroughly.

COOKING GUIDE

Oven cooking guidelines

IMPORTANT!

- Use all the oven modes with the oven door closed.
- Never use aluminum foil to cover the oven shelves or to line the floor of the oven. The trapped heat can irreversibly damage the enamel and may even cause fire.
- Do not place water, ice, or any dish or tray directly on the oven floor, as this will irreversibly damage the enamel.
- Do not cover the broil pan with aluminum foil. This will catch the grease and could cause fire.
- Do not use plastic wrap or wax paper in the oven.
- For food safety reasons, do not leave food in the oven for longer than two hours before and after cooking or defrosting. This is to avoid contamination by organisms which may cause food poisoning. Take particular care during warmer weather.

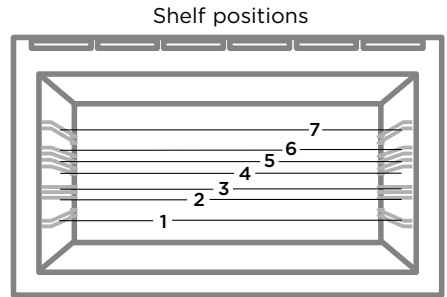
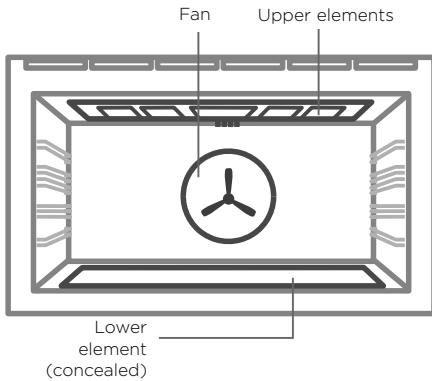

BAKING

- For best results when baking, always pre heat your oven. The temperature halo will change from red to white when the set temperature is reached.
- While the oven is heating the broil element will be on.
- We advise you do not open the door until at least $\frac{3}{4}$ of the way through cooking.
- Make sure cake pans do not touch each other or the sides of the oven.
- When baking double the recipe (especially cookies) cook time may need to increase.
- Your cookware will influence baking times. Dark pans absorb the heat more quickly than reflective pans; glass cookware may require a lower temperature.
- Multi-shelf baking may also require a slight increase in cooking time.

Shelf Position Guide

- Single shelf: place your baking on a shelf that will have the top of your pan near the center of the oven cavity.
- Multi shelf: always leave a space between shelves to allow the air to circulate.

COOKING GUIDE

Oven cooking guidelines

ROASTING

- The Roast function is designed to brown the outside of the meat but still keep the inside moist and juicy.
- Boneless, rolled or stuffed roasts take longer than roasts containing bones.
- Poultry should be well cooked with the juices running clear and an internal temperature of 165°F / 74°C.
- If using a roasting bag, do not use the Roast function. The initial searing stage is too hot for roasting bags. Use Aero Bake or True Aero and follow the manufacturer's instructions.
- When using the Roast function, do not cover your roast, as this will stop the searing process browning the outside of the meat. If you prefer to roast in a covered pan, use the Aero Bake function instead and increase the temperature by 70°F / 20°C.
- Cook larger cuts of meat at a lower temperature for a longer time. The meat will cook more evenly.
- Always roast meat fat side up. That way, basting may not be required.
- Always rest the meat for at least 10 minutes after roasting to allow the juices to settle.
- Remember the meat will continue to cook for a few minutes after removing it from the oven.

Shelf Position Guide

Place the meat on a shelf so that it is in the center of the oven or lower.

BROILING

- This is a healthier alternative to frying.
- Always broil with the oven door completely shut.
- For best results allow 5 minutes of preheat before placing food in the oven.
- If you use glass or ceramic pans, be sure they can withstand the high temperatures of the broil.
- To avoid piercing the meat and letting juices escape, use tongs or a spatula to turn the meat halfway through cooking.
- Brush meat with a little oil to help keep the meat moist during cooking. Alternatively marinate the meat before broiling (but be aware that some marinades may burn easily).
- Where possible broil cuts of meat of a similar thickness at the same time. This will ensure even cooking.
- Always keep a close watch on your food while broiling to avoid charring or burning.

Shelf Position Guide

- For thinner cuts of meat, toasting or browning foods, use a higher shelf position.
- Thicker cuts of meats should be broiled on lower shelves or at a lower broil setting to ensure even cooking.

REHEATING

- Use Bake or Aero Bake to reheat food.
- Bake and Aero Bake are particularly good for reheating pastry based items, as the base heat will help re-crisp the pastry case.
- Always reheat food to piping hot. This reduces the risk of contamination by harmful bacteria.
- Once hot, set the oven temperature to WARM in or use the warming drawer to keep food hot.

Never reheat food more than once.

OVEN FUNCTIONS

IMPORTANT!

- Use all the functions with the oven door closed.



BAKE

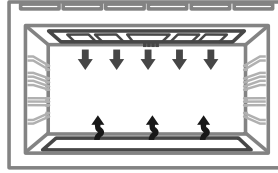

upper outer and lower elements

- Heat comes from both the upper and lower elements. The fan is not used in this function.
- Ideal for cakes and foods that require baking for a long time or at low temperatures.
- This function is not suitable for multi-shelf cooking.

Ideal for moist foods that take a longer time to cook eg rich fruit cake, or bread.



TRUE AERO

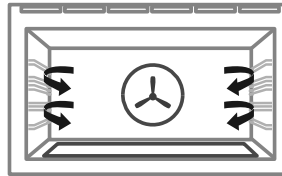

fan and rear element

- By using the central rear heating element and fan, hot air is blown into the cavity, providing a consistent temperature at all levels, making it perfect for multi-shelf cooking.
- Trays of cookies cooked on different shelves are crisp on the outside and chewy in the middle.
- Meat and poultry are deliciously browned and sizzling while remaining juicy and tender.
- Casseroles are cooked to perfection and reheating is quick and efficient.
- When multi-shelf cooking it is important to leave a gap between trays (eg use shelves 3 & 5) to allow the air to move freely. This enables the browning of foods on the lower tray.
- If converting a recipe from Bake to True Aero, we recommend that you decrease the bake time or decrease the temperature by approximately 70°F / 20°C.
- For items with longer bake times (eg over an hour) it may be necessary to decrease both time and temperature.

Ideal for multi-shelf cooking biscuits, cookies, scones, muffins and cupcakes.

OVEN FUNCTIONS



MAXI BROIL

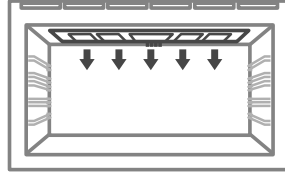

upper inner and outer elements

- Intense radiant heat is delivered from both top elements. You can use Maxi Broil on Low OR High (100% power).
- For best results allow 5 minutes of preheat before placing food in the oven.
- The temperature halo will remain white while using the broil function.
- The most suitable function for 'finishing off' many meals, for example browning the top of potato gratin and frittata.

Ideal for toasting bread or for top browning to 'finish off dishes'.



AERO BROIL

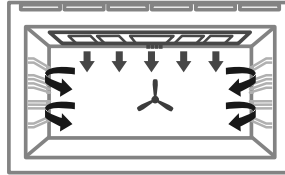

fan plus upper inner and outer elements

- This function uses the intense heat from the elements for top browning and the fan to ensure even cooking of foods.
- Meat, poultry and vegetables cook beautifully; food is crisp and brown on the outside while the inside remains moist and tender.

Ideal for whole chicken, tenderloin of beef or broiling your favourite chicken, fish or steak.



AERO BAKE

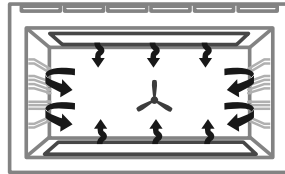

fan plus upper outer and lower elements

- The oven fan circulates hot air from the top outer and the lower elements and distributes it around the oven cavity.
- Food cooked tends to brown more quickly than foods cooked on the traditional Bake function.
- You may need to decrease the time from that recommended in traditional recipes.

Ideal for single shelf baking that takes less than an hour to cook - foods such as muffins, biscuits and cupcakes or things like enchiladas.

OVEN FUNCTIONS

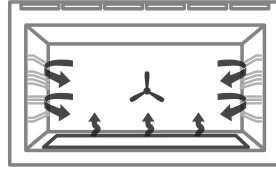

fan plus lower element

- The fan circulates heat from the lower element throughout the oven.
- Excellent for cooking pizza and flatbreads as it crisps the base beautifully without overcooking the top.
- Set the temperature to  for optimum pizza cooking temperature.

Ideal for foods such as sweet and savoury pastry foods and delicate foods that require some top browning eg frittata, quiche.

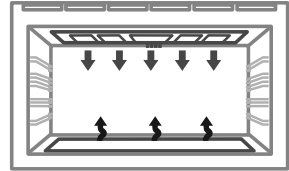
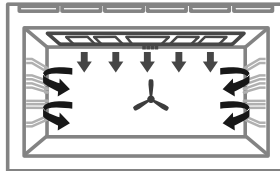

fan plus upper and lower elements

- A two-step program. An initial 20 minute searing stage crisps and browns the roast and caramelises the outside of the meat, then the temperature drops to the level you have preset for the remainder of the cooking period, producing a tender and juicy roast that is full of flavor.
- Oven does not require preheating.
- If desired, use the broil rack or grid, or place vegetables under the roast to allow the juices to drain away from your meat. This will allow the hot air to circulate under the meat as well.

Ideal for Roasting meat, chicken and vegetables.

OVEN FUNCTIONS



RAPID PROOF

this is not a cooking function

- Gentle heat is generated from the upper and lower elements.
- Provides the optimum warm and draft-free environment for proving yeast dough.
- This method provides a faster proof time than at room temperature.
- To prevent overproofing we recommend you check the dough every 30mins.

Proving dough

- ① Place dough in a lightly oiled bowl and cover with plastic wrap and/or a clean damp cloth.
- ② Position the bowl in the center of the oven.
- ③ Select Rapid Proof function.

SELF CLEAN

SELF CLEAN

this is not a cooking function

- Self Clean takes care of the mess and grime that is traditionally associated with oven cleaning.
- There are two Self-Clean cycles available:
 - Standard clean (which takes a minimum of 4 hours) for normal to heavy cleaning
 - Light clean (which takes a minimum of 3 hours) for lightly soiled ovens
- Always clean the inner door glass pane first.
- See 'Using the Self Clean function' for details.

COOKING CHARTS

- Shelf positions are counted from the base up (1 is the lowest, 7 is the highest). Position shelves before you turn the oven on.
- For best results preheat the oven.
- Multi-shelf cooking may need the shelves rotating midway through cooking.
- Oven accessories may temporarily deform slightly when they become hot. This is normal and does not affect their function.

BAKING

FOOD		SHELVES
Biscuits	Plain	Single
		Multi
	Chewy Choc Chip	Single
		Multi
	Sugar Cookies	Single
	Multi	
Cakes	Pound Cake	Single
	Chocolate Brownie (8"x8"/20x20cm pan)	Single
	Angel Food Cake (10"x4"/25x10cm tube pan)	Single
	Rich Fruit Cake	Single
	Sponge (single large)	Single
	Sponge (2x20cm)	Single
Muffins / Cupcakes	Cupcakes	Single
		Multi
	Muffins	Single
		Multi
Scones	English Scones	Single
Meringues	Meringues	Single
Bread/Bread rolls	Sandwich Loaf (9"x5"/23x13cm Loaf Pan)	Single
	Wholewheat Loaf (9"x5"/23x13cm Loaf Pan)	Single
	Soft Dinner Rolls	Single
	Dough proof	Single
Pastry	Pastry Shell (baked blind)	Single
	Phyllo	Single
	Flaky / Puff	Single
	Choux	Single
		Multi
	Croissants	Single
		Multi
Pies	Fruit pie (double crust)	Single
	Baked Cheesecake (in water bath)	Single
	Pumpkin Pie (blind bake, then filled)	Single
	English Custard Tart (blind bake, then filled)	Single
Dessert	Crème Brulee (in water bath)	Single
	Crème Caramel (in water bath)	Single

COOKING CHARTS

The information in these charts are guidelines only. Refer to your recipe or the packaging and be prepared to adjust the cooking times and settings accordingly.

FUNCTION	SHELF POSITIONS	TEMP (°F)	TEMP (°C)	TIME (MINS)
Aero Bake	3	400 - 425	210 - 220	8 - 10
True Aero	2 & 5	425 - 450	215 - 230	10 - 12
Aero Bake	3	355 - 375	180 - 190	10 - 15
True Aero	2 & 5	325 - 340	160 - 170	10 - 15
Aero Bake	3	350 - 375	175 - 190	7 - 15
True Aero	2 & 5	325 - 350	160 - 175	7 - 15
Bake	3	325	160	70 - 80
Bake	3	350	175	20 - 25
Bake	3	325 - 350	160 - 175	50 - 60
Bake	3	275 - 300	135 - 150	3 - 6 hrs
Bake	3	350	175	30 - 40
Bake	3	350	175	15 - 25
Aero Bake	3	365	185	13 - 18
True Aero	2 & 5	345	170	13 - 18
Aero Bake	3	345	170	23 - 30
True Aero	2 & 5	345	170	23 - 30
Bake	3	425 - 450	215 - 230	10 - 12
Bake	3	250 - 270	120 - 130	60 - 70
Bake	3	350	175	40 - 50
Bake	3	375	190	35 - 45
Bake	3	375	190	15 - 18
Rapid Proof	3	-	-	30
Aero Pastry	2	350	175	15
Aero Bake	3	390	200	15 - 25
Aero Bake	3	390	200	20 - 30
Aero Bake	3	390 - 400	200 - 210	30 - 35
True Aero	2 & 5	390 - 400	200 - 210	30 - 35
Aero Bake	3	375 - 390	190 - 200	15 - 25
True Aero	2 & 5	375 - 390	190 - 200	15 - 25
Aero Bake	3	350 - 400	175 - 200	20 - 25
Aero Pastry	3	325	160	50 - 60
Aero Pastry	3	350 - 375	175 - 190	15 - 30
Aero Pastry	3	300 - 350	150 - 175	15 - 30
Aero Pastry	3	275	135	35 - 45
Aero Pastry	3	350	175	35 - 45

COOKING CHARTS

SAVOURY

FOOD	SHELVES
Cornbread	Single
Vegetables	Single
Lasagne	Single
Casserole	Single
Pizza	Single
Quiche (blind bake, then add filling)	Single
Potatoes (whole, baked)	Single
Frittata (shallow)	Single
Oven Meals	Single

ROASTING

FOOD	SHELVES *	RECOMMENDED MODE	
Beef (Boneless)	Rare	Roast	
	Medium	Roast	
	Well Done	Roast	
Prime Rib Roast	Rare	Roast	
	Medium	Roast	
	Well Done	Roast	
Lamb Rack	Single	Roast	
Lamb leg (Bone in)	Medium	Roast	
	Well Done	Roast	
Lamb leg (Boneless)	Medium	Roast	
	Well Done	Roast	
Veal	Medium	Roast	
	Well Done	Roast	
Chicken	Whole Unstuffed	Aero Broil	
	Whole Stuffed	Bake	
	Whole Butterflied	Aero Broil	
Turkey (Whole)	Stuffed	Bake	
	Unstuffed	Bake	
Pork (Boneless)	Medium	Roast	
	Well Done	Roast	
Pork Crackling	Single	Aero Broil	
Venison	Brown in a pan first.	Rare	Aero Broil
		Medium Rare	Aero Broil

COOKING CHARTS

FUNCTION	SHELF POSITIONS	TEMP (°F)	TEMP (°C)	TIME (MINS)
Aero Bake	3	400 - 425	210 - 215	20 - 25
Aero Bake	3	350 - 375	175 - 190	30 - 50
Aero Bake	3	350 - 375	175 - 190	35 - 40
Bake	2 or 3	250 - 350	120 - 175	2 - 4 hours
Pizza	2	550 (pizza)	220	10 - 15
Aero pastry	3	350	175	15 - 30
Bake	3	390	200	50 - 60
Aero Pastry	3	340 - 360	170 - 180	15 - 20
True Aero	3	340 - 375	170 - 190	30 - 40

SHELF POSITIONS	TEMP (°F)	TEMP (°C)	TIME (MINS)	MEAT PROBE (°F) **	MEAT PROBE (°C) **
3	320 - 340	160 - 170	18 - 32 /450g	130 - 138	54 - 59
3	320 - 340	160 - 170	25 - 40 /450g	140 - 165	60 - 74
3	320 - 340	160 - 170	30 - 55 /450g	165 - 174	74 - 79
3	320 - 340	160 - 170	15 - 30 /450g	130 - 138	54 - 59
3	320 - 340	160 - 170	20 - 35 /450g	140 - 165	60 - 74
3	320 - 340	160 - 170	25 - 40 /450g	165 - 174	74 - 79
3	390	200	20	122	50
3	320 - 340	160 - 170	18 - 28 /450g	149 - 158	65 - 70
3	320 - 340	160 - 170	20 - 33 /450g	165 - 174	74 - 79
3	320 - 340	160 - 170	20 - 35 /450g	149 - 158	65 - 70
3	320 - 340	160 - 170	25 - 45 /450g	170 - 174	77 - 79
3	320 - 340	160 - 170	20 - 40 /450g	160	71
3	320 - 340	160 - 170	25 - 45 /450g	170	76
3	350	175	15 - 20 /450g	165	75
3	350	175	17 - 22 /450g	165	75
4	350	175	40 - 50	165	75
2 or 3	320 - 340	160 - 170	17 - 22 /450g	165	75
2 or 3	300 - 330	150 - 165	15 - 20 /450g	165	75
3	340 - 350	170 - 175	25 - 40 /450g	145 - 154	63 - 68
3	340 - 350	170 - 175	30 - 45 /450g	165 - 174	74 - 79
4	430	220	5 to 10	-	-
3 or 4	435	225	7 /2.5cm meat thickness	120 - 129	49 - 54
3 or 4	435	225	9 /2.5cm meat thickness	131 - 140	55 - 60

COOKING CHARTS

BROILING

FOOD		SHELVES	
Beef	Steak	Rare	Single
		Medium	Single
	Hamburger (ground - patties)		Single
	Meatballs (ground)		Single
Lamb Chops		Medium	Single
		Well done	Single
Pork	Chops (well done)		Single
	Ham steak		Single
	Bacon		Single
	Sausages		
Chicken	Boneless pieces		Single
	Bone In Pieces		Single
Fish	Fillets		Single
	Whole		Single
Vegetables	Sliced		Single

COOKING CHARTS

FUNCTION	SHELF POSITIONS	TEMP (°F)	TEMP (°C)	TIME (MINS)
Maxi Broil	6 or 7	HI	HI	8 - 10
Maxi Broil	6 or 7	HI	HI	10 - 15
Maxi Broil	6 or 7	HI	HI	12 - 15
Maxi Broil	6 or 7	HI	HI	12 - 15
Maxi Broil	6 or 7	HI	HI	15 - 20
Maxi Broil	6 or 7	HI	HI	20 - 25
Maxi Broil	6 or 7	HI	HI	15 - 20
Maxi Broil	6 or 7	HI	HI	15 - 20
Maxi Broil	6 or 7	HI	HI	4 - 7
Maxi Broil	6 or 7	HI	HI	10 - 15
Aero Broil	4 or 5	350	175	30 - 40
Aero Broil	4 or 5	350	175	40 - 50
Aero Broil	5 or 6	390 - 430	200 - 220	8 - 12
Aero Broil	5 or 6	390 - 430	200 - 220	15 - 20
Maxi Broil	5 or 6	HI	HI	8 - 12

SETTING THE TIMER

- You can use the timer at any time, even if you are not using the oven.
- If the time is more than an hour, the display will count down in minutes (h:m). If it is less than an hour, it will count down in seconds (m:s).
- You can set the timer for up to 23 hours 59 minutes.

IMPORTANT!

The timer does NOT turn the oven off.

To set the timer

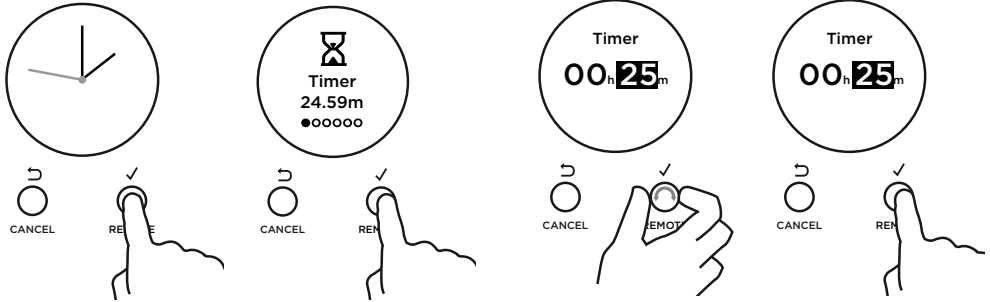

- ① Press ✓ to enter the main menu.
 - The timer will be the first option.
 - Press ✓ to enter the timer.
- ② Scroll to set the minutes.
 - Press ✓ to confirm.

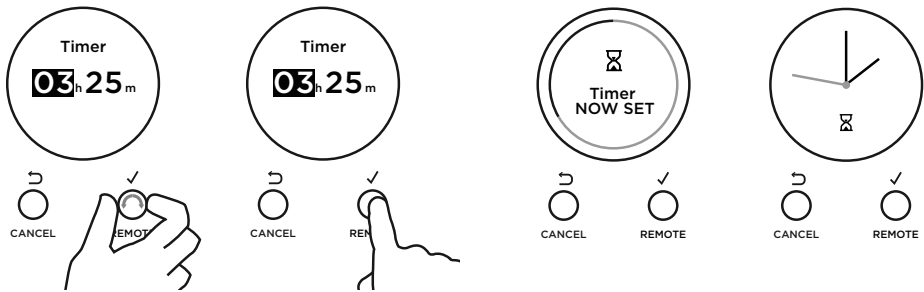

- ③ Scroll to set hours.
 - Press ✓ to confirm.

The timer is now set and will begin counting down. Press ⏪ or scroll to return to the time of day.

SETTING THE TIMER

To edit the timer

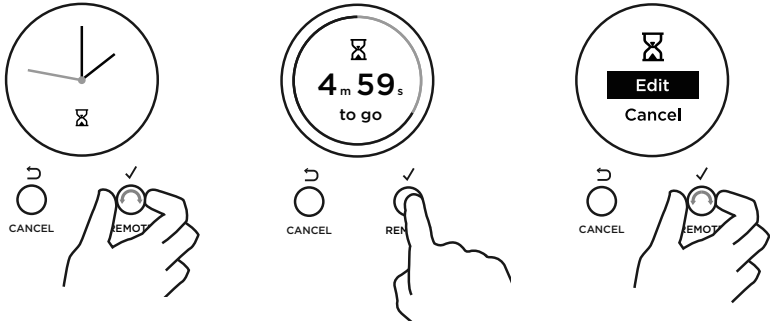

- ① From the home screen, scroll to view the active timer.
- ② Press ✓ to enter the timer.
- ③ Scroll to select Edit.
- ④ Press ✓ to confirm.
- ⑤ Follow the steps previous to adjust the timer.

To cancel the timer

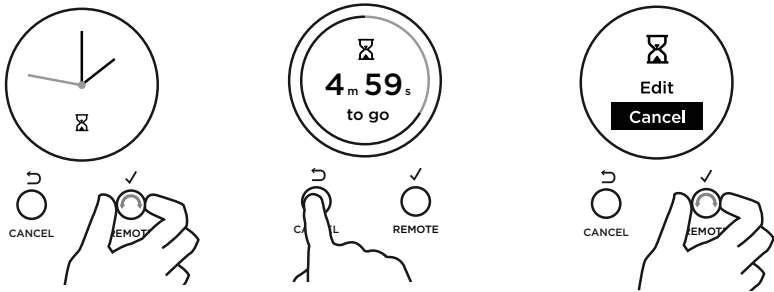

- ① From the home screen, scroll to view the active timer.
 - Press and hold CANCEL to cancel the timer, or follow the steps below:
- ② Press ✓ to enter the timer.
- ③ Scroll to select Cancel.
- ④ Press ✓ to confirm and exit the menu.

When the set time is up

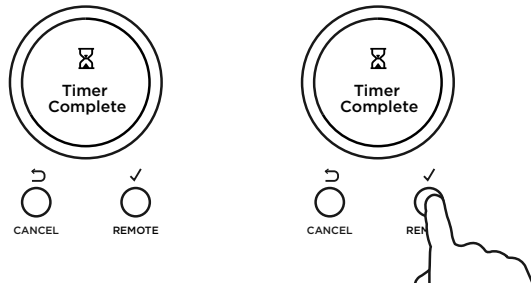

- ① Timer Complete will appear and the display will flash. A tone will sound every few seconds.
- ② Press ✓ or CANCEL to stop the tone sounding.

AUTO COOK

Use Auto Cook to

- Turn off the oven automatically after a set period of time.
- Set the oven for food to be ready at a specific time.

Before you start

- Make sure that your oven is displaying the correct time of day and food is in the oven.

IMPORTANT!

Safe food handling: leave food in the oven for as short as time as possible before and after cooking or defrosting. This is to avoid contamination by organisms which may cause food poisoning. Take particular care during warmer weather.

You can choose to either start cooking now or set a delayed cook.

- Choose Start Now if you have started cooking and want to set the oven to turn off automatically after a set period of time.
- Choose Delayed Cook to set the oven to automatically turn on later and be ready at a set time.

To set Auto Cook

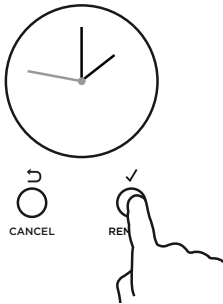

- ① Press ✓ to enter the main menu.

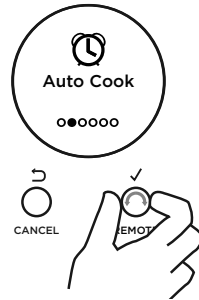

- ② Scroll through the menu options to Auto Cook.
- Press ✓ to enter Auto Cook.



- ③ Scroll to choose between Cook Now and Delayed Cook.
- Press ✓ to accept.

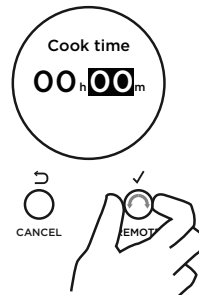
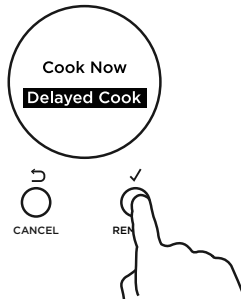

- ④ Set the Cook time.
- Scroll to set the minutes.
 - Press ✓ to accept.

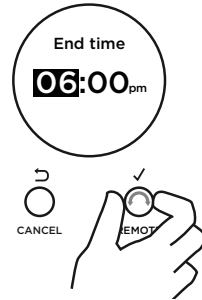
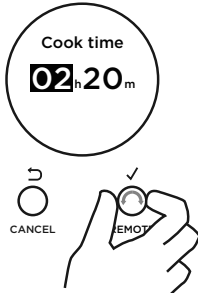

- ⑤ Scroll to set the hours.
- Press ✓ to accept.

Delayed Cook

To set Delayed Cook you will also need to set an End Time.

- ⑥ Scroll to set the minutes.
- Press ✓ to accept.
- ⑦ Scroll to set the hours.
- Press ✓ to accept.

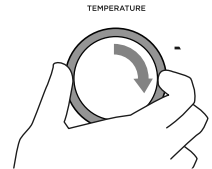
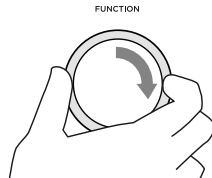
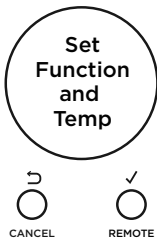

If you have not already set a function and temperature:

- Set Function and Temp will appear in the display.
- The halos on the oven dials will flash.

- ⑧ Set a function and temperature using the oven dials.



The display will show a summary of your settings, showing:

- Start time
- Cook time
- End time

- ⑨ Press ✓ to confirm or ↶ to go back and adjust the settings.

Your oven is now set for automatic cooking.

AUTO COOK

When Auto Cook is set

- The oven and the lights will stay off, the halos will be unlit, but your oven is now set for automatic cooking. It will automatically turn on at the required time.
- You can modify the function and temperature while the oven is waiting to start cooking.
- If setting Delayed Cook you will need to put the food in the oven before starting.
- For safety reasons opening the door while the oven is waiting to start will cancel Delayed Cook.

While the oven is heating up

IMPORTANT!

- **During Auto Cook the grill element will come on while the oven is heating up. Food placed into a cold oven could be prone to burning as the oven heats up.**
- **Large items and foods with a high fat or sugar content are especially prone to burning. Take particular care with foods such as macaroni cheese, large poultry, and enchiladas.**
- **Ideal foods for automatic cooking include stews, casseroles, braised meat and potato top pie.**
- **Position food on a lower shelf to prevent burning.**
- **Where possible cook food in a pan with a lid, or cover food with foil.**

To edit Auto Cook

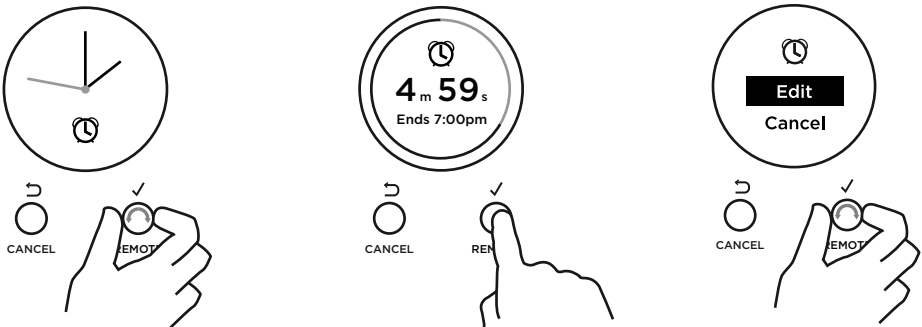

- ① From the home screen, scroll to view Auto Cook.
- ② Press ✓ to enter Auto Cook.
- ③ Scroll to select Edit.
- ④ Press ✓ to confirm.
- ⑤ Follow the steps previous to adjust the Cook or End time.

AUTO COOK

To cancel Auto Cook

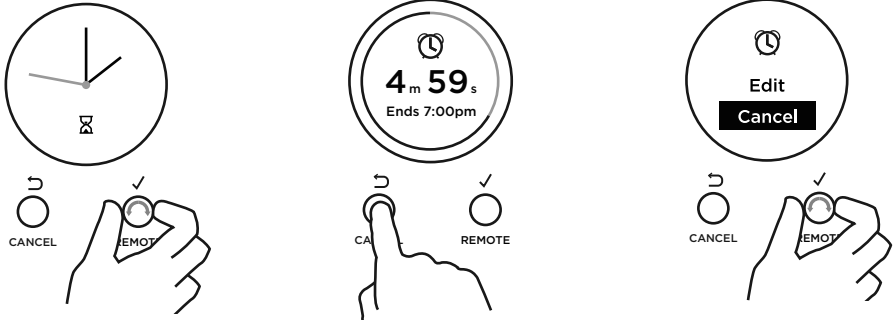

- ① From the home screen, scroll to view the active timer. Press and hold CANCEL to cancel Auto Cook, or follow the steps below. *Turning both dials to 0 (OFF) will also cancel Auto Cook.*
- ② Press ✓ to enter Auto Cook.
- ③ Scroll to select Cancel.
- ④ Press ✓ to confirm.

When the set time is up

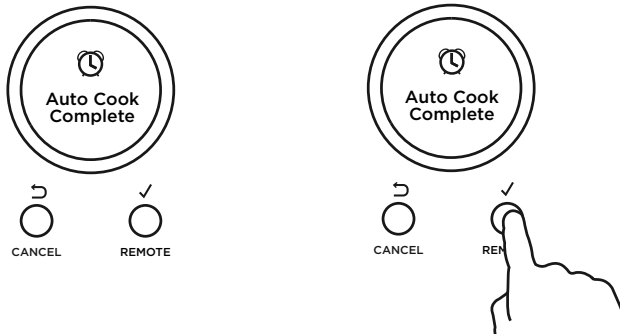

- ① Auto Cook Complete will appear and the display will flash. A tone will sound every few seconds.
- ② Press ✓ or CANCEL to stop the tone sounding.
- ③ Turn both the oven dials back to 0 (OFF).

LOCKING THE OVEN CONTROLS

This function is to prevent accidental use of the oven (eg by children).
When locked, the controls are unresponsive and the oven will not turn on.

IMPORTANT!

- This does not lock the cooktop controls.
- For safety reasons it is not possible to lock the oven controls while the oven is in use or if Auto Cook has been set.

To lock:

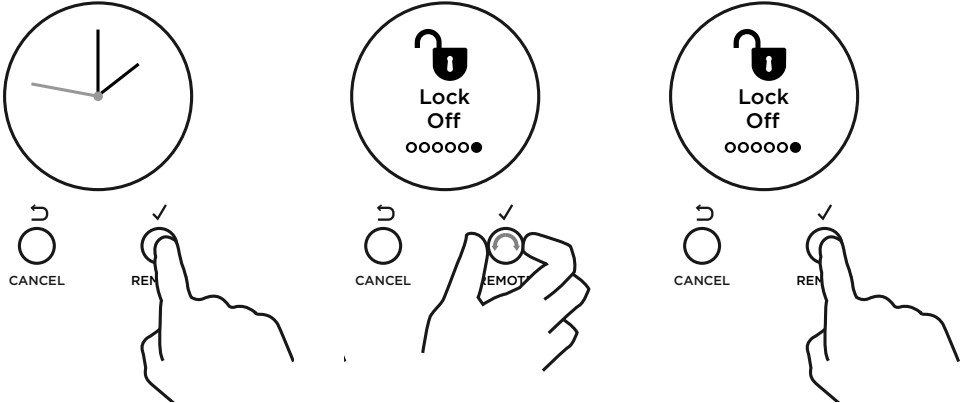

- ① Press ✓ to enter the main menu.
- ② Scroll through the menu options to get to Lock.
- ③ Press ✓ to enter the Lock menu.

LOCKING THE OVEN CONTROLS

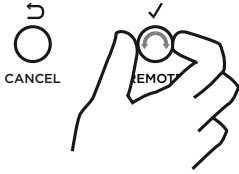
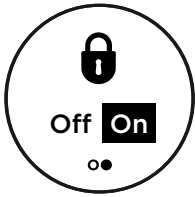

- ④ Scroll through the Lock options to ON.

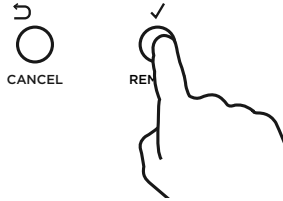

- ⑤ Press ✓ to confirm.
- The control panel is now locked.

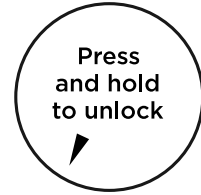

- To unlock:**
- Press and hold CANCEL to unlock the oven controls.

USER PREFERENCE SETTINGS

Adjust the user settings to suit your personal setup preferences.

You can set your oven to:

- display the temperature in degrees Celsius or Fahrenheit
- give audio feedback (tones and beeps) or operate quietly
- display time as 12-hr or 24-hr
- operate with the display off
- have its lights on or off during cooking
- operate in Sabbath setting (see 'Sabbath setting' following)

Note: you cannot change the user preference settings when you oven is operating or set for automatic cooking.

How to change preference settings

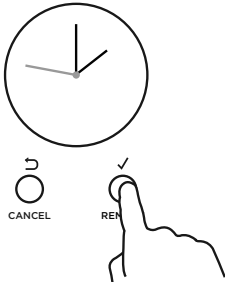

- ① From the home screen, press ✓ to enter the main menu.

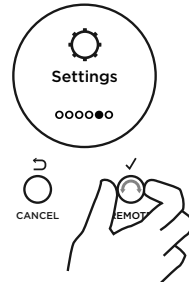

- ② Scroll through the menu options to settings.
 - Press ✓ to enter the settings menu.

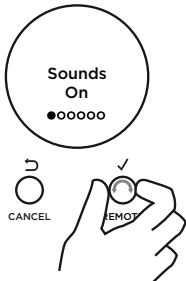

- ③ Scroll to the setting you want to change.
 - Press ✓ to edit the setting.

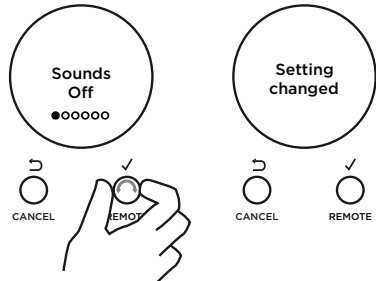

- ④ Scroll between the options for each setting. See refer to the table following for which options are available.
 - Press ✓ to confirm.
- ⑤ The display will confirm that you have changed the setting.

USER PREFERENCE SETTINGS

SETTING	DEFAULT OPTION	ALTERNATIVE OPTION(S)		
CLOCK DISPLAY Select between: <ul style="list-style-type: none"> • Analog and digital display • 12-hr and 24-hr display • Display off** Turn the display off if you only want to use the basic functionalities of your oven.	ANALOG 	24 HR 24:00	12 HR 12:00	DISPLAY OFF** Clock display Off
TEMPERATURE SCALE Select between degrees Celsius or Fahrenheit.	FAHRENHEIT Degrees Fahrenheit	CELSIUS Degrees Celsius		
AUDIO FEEDBACK Turn the oven beeps and tones on or off.*	SOUNDS ON Sounds On	SOUNDS OFF Sounds Off		
OVEN LIGHTS Have the light off during cooking if you want to save power or want the food you cook to be a surprise for others.	LIGHTS ON DURING COOKING Lights On	LIGHTS OFF DURING COOKING Lights Off		
SABBATH MODE	SABBATH OFF Sabbath Off	See 'Sabbath Mode' for instructions		
LANGUAGE Choose the language you would like the oven to display in.	US ENGLISH US English	US ENGLISH US English	SPANISH Espanol	FRENCH Francaise
WIRELESS CONNECTION Not available on this product.	OFF WiFi Off			
USER SETTINGS RESET Use this to clear all changes to settings and reset to the factory settings.	RESET Reset	Select this option and accept to reset all user settings		

* The timer tone and alert beeps will sound even if you save the SOUNDS OFF option.

** With this option saved, you can still use the oven, and timer, however the display will remain unlit.

Any automatic functions will be cancelled when this option is selected.

To quit this option and enable the display, press and hold CANCEL.

SABBATH MODE

This setting is designed for religious faiths that observe a 'no work' requirement on the Sabbath.

While your oven is in Sabbath Mode

- The display, dial halos and indicators will be unlit, the controls will be unresponsive.
- No tones or beeps will sound.
- No alert codes or temperature changes will be displayed.
- The oven lights will stay on. If you want the oven lights to be off during Sabbath Mode, first select the 'Lights off' option as described in 'User preference settings', and then set Sabbath Mode afterwards.
- Bake  is the only function available in Sabbath Mode.

How to set Sabbath Mode

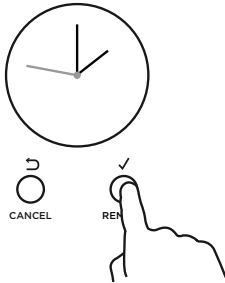

- ① From the home screen, press ✓ to enter the main menu.

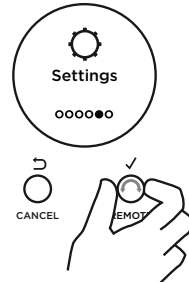

- ② Scroll through the menu options to settings.
- Press ✓ to enter the settings menu.

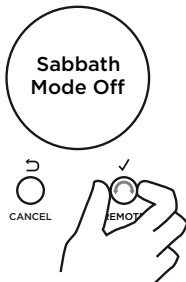

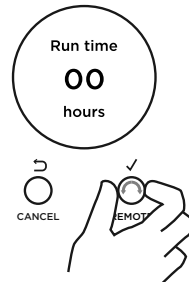

- ③ Scroll through the menu options to Sabbath Mode.
- Press ✓ to enter the Sabbath Mode setting.



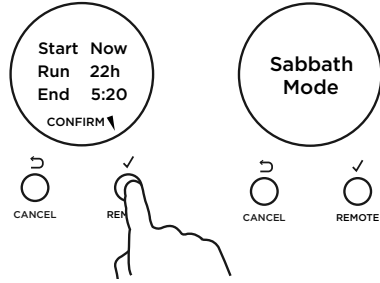
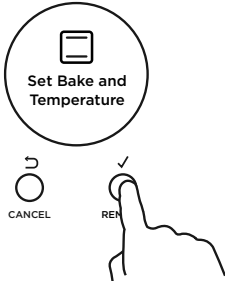

- ④ Scroll to set the time. You may set the time up to 48 hours.
- Press ✓ to confirm.

SABBATH MODE



- ⑤ Select the Bake  function.
- ⑥ Set the desired temperature.

The display will show a summary of your settings, showing:

- Start time
 - Run time
 - End time
- ⑦ Press  to confirm or  to go back and adjust the settings.

The display, indicators and dial halos will be unlit and unresponsive, but the oven will bake until you quit Sabbath Mode.

To quit Sabbath Mode

Press and hold CANCEL until the time of day appears in the display, or turn either oven dial back to 0 (OFF).

USING YOUR GAS COOKTOP

OR36 models

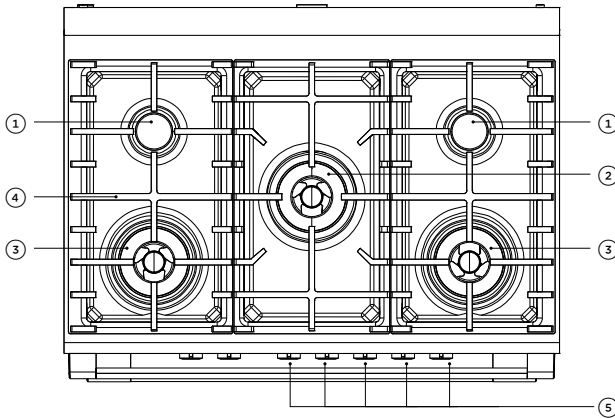

Cooktop features

- ① Semi-rapid burner
- ② Dual wok burner
- ③ Triple-ring burner
- ④ Burner grates
- ⑤ Burner dials

OR30 models

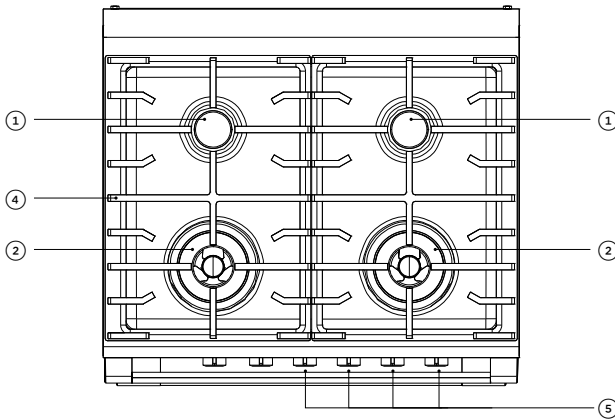

Using the dual wok burners

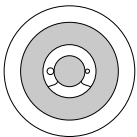

Inner and outer burners

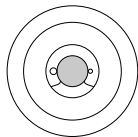

Inner burner only

When using a dual wok burner, you can choose to use the inner burner only or both the inner and outer burners as desired.

The lowest burner setting on the range is the inner ring of the dual wok burner. This can be used for delicate simmering or the melting of chocolate.

USING YOUR GAS COOKTOP

Burner Controls

The dials control the flow of gas through the valve.

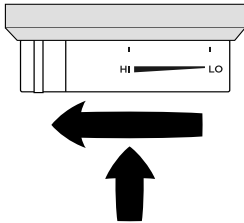

Using the single burners

- ① Identify the knob of the burner you want to use.
- ② Starting from the O (OFF) position, push the knob in and turn it counterclockwise to HI.
 - Keep holding the knob in until the broil burner lights and continue to hold for a couple of seconds after.

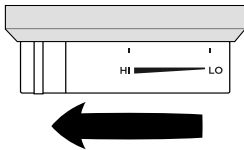

- ③ When the burner has lit, adjust the flame anywhere between HI and LO.
 - Do not adjust the knob between HI and O (OFF).

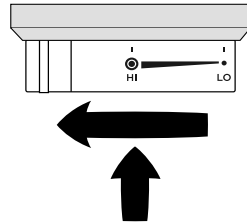

Using the dual burner

- ① Starting from the O (OFF) position, push the knob in and turn it counterclockwise to either HI (with a dot) to light both the inner and outer rings or HI (with a circle) to light the inner ring only.

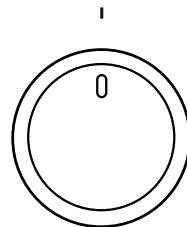

- ③ When you have finished cooking, turn the knob clockwise back to O (OFF).
 - If you are using LP gas, there may be a slight 'extinction pop' or flash at the flame spreader a few seconds after the burner has been turned off. This is normal for LP gas.

USING YOUR GAS COOKTOP

If a burner does not light

Turn the control dial to O (OFF) and wait at least one minute before trying again, to all the gas to disperse.

If the burner still does not light, check that:

- the range is plugged in and the power supply is switched on
- there is no power failure in your home or neighborhood
- the gas is turned on
- the gas bottle is not empty (if you use bottled gas)
- the flame spreaders are clean and the holes are not clogged
- the ignitors are sparking. If they are not sparking, they may be dirty or wet. Clean them with a toothbrush and methylated spirits, as shown below. See 'Care and cleaning' for instructions on removing and replacing the burner parts.

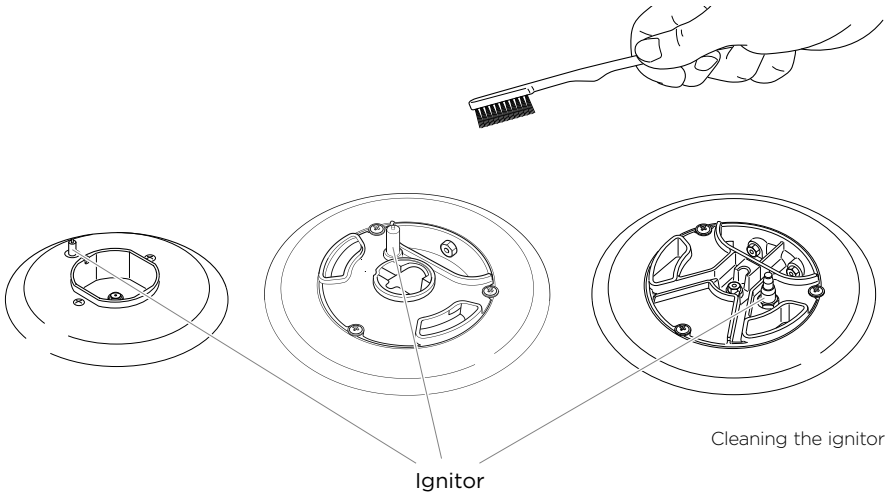

If the flame is irregular

Check that the burner parts (flame spreader and burner cap) are:

- clean and dry
- positioned correctly, as shown below
- For further advice, see sections 'Care and cleaning' and 'Troubleshooting'.

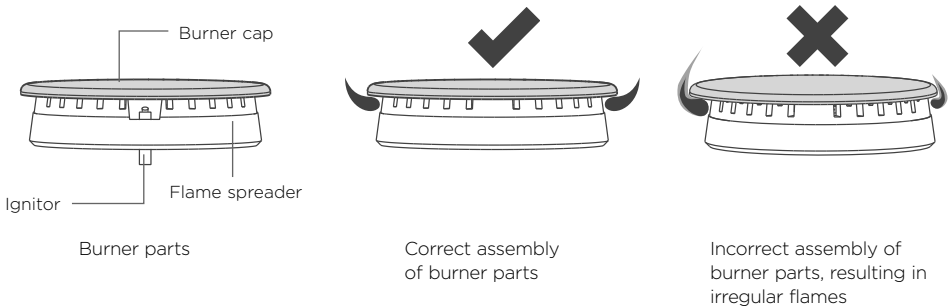

COOKING GUIDELINES AND COOKWARE

Cooking guidelines

IMPORTANT!

- **Never leave the cooktop unattended when in use. Boilover causes smoking and greasy spills that may ignite.**
- **Take care when deep-frying: oil or fat can overheat very quickly, particularly on a high setting.**
- Start cooking on a high setting. When food comes to the boil, reduce the setting and maintain a steady heat to cook your food thoroughly. Doing this will reduce the cooking time.
- Using a lid will reduce cooking times through retaining the heat.
- Minimise the amount of liquid or fat to reduce cooking times.
- Use the lowest setting on the dual wok burner to maintain low heat for turn down and simmering.

Cookware

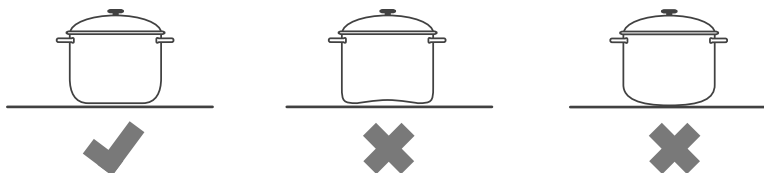

- Use saucepans with thick flat bases. Food in a saucepan with an uneven base will take longer to cook.
- Do not let large saucepans or frying pans overlap the bench, as this can deflect heat onto your benchtop and damage its surface.
- Always make sure saucepans are stable. Using very heavy saucepans may bend the pan supports or deflect the flame.
- Make sure the size of the pan matches the size of the burner. A small pot on a large burner is not efficient.

The following table shows the minimum and maximum saucepan base diameters that may be used on each burner:

BURNER	MINIMUM DIAMETER	MAXIMUM DIAMETER
Semi-rapid	6.5" (16cm)	10" (24cm)
Triple-ring wok	10.5" (26cm)	11" (28cm)
	Maximum diameter for woks 14" (36cm)	
Dual (inner crown only)	4.8" (12cm)	5.5" (14cm)
Dual (inner and outer crowns)	10.5" (26cm)	11" (28cm)
	Maximum diameter for woks 14" (36cm)	

COOKING GUIDELINES AND COOKWARE

Wok stand

The wok stand fits over the triple-ring wok or dual burner trivet.

IMPORTANT!

- Using a wok without the stand may cause the wok to tip or the wok or dual burner to operate incorrectly.
- Do not use the stand for ordinary, flat-bottomed saucepans.
- The wok stand **MUST BE PLACED ONLY** over the trivet for the triple-ring wok or dual burner.
- The cooktop becomes very hot during operation. Keep children well out of reach.

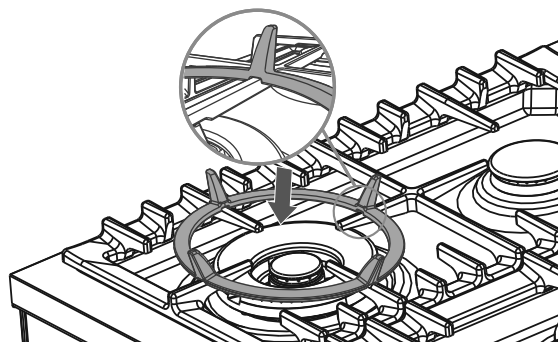
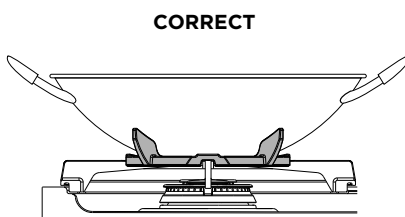
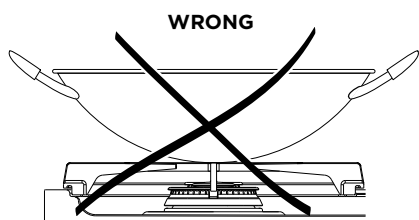

Correct placement of wok stand

USING THE WARMING DRAWER

Use the warming drawer to keep food warm after you have finished cooking and to warm plates before serving. The warming drawer will keep hot cooked foods at serving temperature.

- Allow time for the drawer to preheat
- Place hot food in a heatproof pan or serving dish.
- Take care when opening the drawer. Position your hand at the bottom of the drawer and open slowly to allow hot air and steam to escape.
- Take care not to touch the inside surfaces of the drawer while it is hot.
- When using the drawer to warm plates ensure the temperature is only set to LO. Ensure plates are evenly spread out.
- Do not stack dishes or plates as this may result in uneven heating.

WARMER



To use the warming drawer

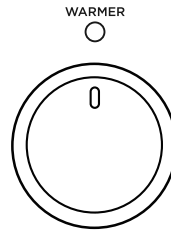
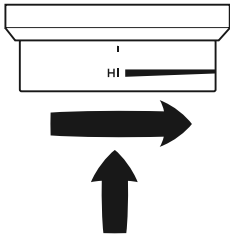

- ① Push in the warmer dial and turn clockwise to HI.
 - While the drawer is on the indicator will glow red.
- ② When you have finished using the drawer turn the dial back to 0 (OFF).
 - The indicator will go out.

Warmer dial

- The temperature can be set anywhere between LO (minimum) and HI (maximum).
- The warming drawer is fitted with an heating element in the top.
- The maximum heat will differ depending on your electrical connection (220W at 240V, 165W at 208V).
- See the below table for the temperature settings.

DIAL POSITION	°F (240V)	°C (240V)	°F (208V)	°C (208V)
LO	86	30	86	30
HI	167	75	149	65

IMPORTANT!

- Do not use the drawer to re-heat food.
- Do not place food in the drawer in unopened containers. Built up pressure could cause the container to burst.
- Do not use plastic containers.
- Use dry potholders to transfer dishes to and from the drawer. Take care not to let potholders touch the hot upper element.
- Do not store flammable items in the drawer.
- Do not use the warmer drawer as a storage drawer.
- Do not use aluminum foil to line the drawer.
- Make sure the dial is always set to O (OFF) when running a self clean cycle and any time when the drawer is not in use.

CARE AND CLEANING

DOS

- Read these cleaning instructions and the 'Safety and warnings' section before you start cleaning your range.
- Before cleaning or removing any part, make sure that everything on the range has been turned off.
- Unless suggested otherwise in the chart following, allow any part to cool to a safe temperature before cleaning. If you do need to handle a warm or hot part, take extreme care. Wear long protective mitts to avoid burns from steam or hot surfaces.
- Try using any cleaner on a small area first, to ensure it doesn't stain.
- See the pages following this chart for instructions on removing and replacing different parts of the range for cleaning or maintenance.
- To help you identify any parts, see illustrations in section 'Introduction' and after this cleaning chart.
- Ensure the anti-tip device is re-engaged if you move the range for cleaning. Failure to do this may result in the oven tipping, and adults and children may be killed.
- To prevent soiling from becoming 'baked on' and stubborn, we recommend removing any easy-to-reach spills, food or grease stains from the oven cavity enamel after each use.
- Always clean the inner glass pane before starting a Self Clean cycle. Failure to do this will mean that residue will bake on and be impossible to remove.
- Always remove oven shelves before starting a Self Clean cycle.

DON'TS

- **Do not use aerosol cleaners until the range has completely cooled. The propellant substance in these cleaners could catch fire in the presence of heat.**
- **Do not let soiling or grease accumulate anywhere in or on the range. This will make future cleaning more difficult and may present a fire hazard.**
- **Do not use any abrasive or harsh cleaners, cloths, scouring pads or steel wool. These will scratch your range and damage its appearance.**
- **Do not use a steam cleaner to clean any part of the range.**
- **Do not perform any cleaning or maintenance on parts not specifically named in the chart below. If in doubt, contact Customer Care.**
- **Only a service technician can take apart the door.**
- **Do not attempt to take the door apart for cleaning. If the inner panes of glass in the door become dirty, please contact your Repairer or Customer Care.**

CARE AND CLEANING

Manual cleaning chart

WHAT? HOW OFTEN?	HOW?	IMPORTANT!
RANGE EXTERIOR		
Door frame exterior, Control panel, Cooktop base Back trim Warming drawer exterior After every use	① Soften any stubborn stains under a hot soapy cloth. ② Clean with a solution of mild detergent and hot water, then wipe dry with a microfiber cloth. Stainless steel models: For extra shine, use a suitable stainless steel cleaner and polish, following manufacturer's instructions. Always rub the stainless steel in the direction of the polish lines.	<ul style="list-style-type: none"> Always read the label to make sure your stainless steel cleaner does not contain chlorine compounds as these are corrosive and may damage the appearance of your cooktop. Do not use and take care not to spill any stainless steel cleaner on the dials, oven handles, or the kickstrip grate. These are not stainless steel parts and their surface may be damaged by stainless steel cleaner.
Dials Oven handles	① Wipe with a damp cloth using a solution of mild detergent and hot water. ② Dry thoroughly with microfiber cloth.	<ul style="list-style-type: none"> Do not use stainless steel cleaner on these parts, as doing so may damage their coating.
Clock display and controls	Take particular care when cleaning the clock and surrounding area. Only use a damp cloth with detergent.	<ul style="list-style-type: none"> Do not use any oven cleaners, harsh or abrasive cleaners, scouring pads, steel wool or sharp metal scrapers on the glass. These may scratch and damage the surface.
Oven door glass (exterior)	Clean using a soft cloth and a mixture of warm water and dishwashing liquid or glass cleaner.	
OVEN PARTS		
Enamel oven interior - <i>light soiling</i>	① Wipe with a damp cloth and a solution of hot water and mild detergent. ② Wipe dry with a soft cloth. Note: the oven door may be removed to make reaching into the oven easier.	<ul style="list-style-type: none"> To prevent soiling from becoming 'baked on' and stubborn, we recommend removing any easy-to-reach spills, food or greasy stains from the enamel after each use. Doing so will reduce the need for using the Self Clean function frequently.
Enamel oven interior - <i>stubborn, 'baked-on' soiling</i>	Run the Self Clean cycle. See "Using the Self Clean function" for instructions.	

CARE AND CLEANING

WHAT? HOW OFTEN?	HOW?	IMPORTANT!
OVEN PARTS		
Side racks	<p><i>For light soiling:</i></p> <ul style="list-style-type: none"> • Clean with a solution of mild detergent and hot water. <p><i>For heavy soiling:</i></p> <ul style="list-style-type: none"> • Run a Self Clean cycle. 	
Oven shelves	Wipe with a damp cloth and mild detergent. Do not wipe off or wash away the white lubricating grease (visible when the shelf is extended).	<ul style="list-style-type: none"> • Never leave in the oven during a Self Clean cycle. • Do not wash the shelf in the dishwasher, immerse in soapy water, or use oven cleaner on it. Doing so will prevent the slides from running smoothly.
Broil pan and rack	① Pre-soak any stubborn soiling in a solution of mild detergent and hot water.	<ul style="list-style-type: none"> • Never leave any of these parts in the oven during a Self Clean cycle. They will become discoloured or damaged.
Rotisserie parts	② Wash by hand or in a dishwasher.	
Upper and lower oven elements	Do not clean these parts. They self-clean during normal use.	
Oven door glass (interior)	<ul style="list-style-type: none"> • Use a soft cloth and a mixture of warm water and dishwashing liquid to remove light soiling after every use. 	<ul style="list-style-type: none"> • Do not use oven cleaners or any other harsh/abrasive cleaners, cloths, scouring pads, steel wool or sharp metal scrapers to clean the oven door glass. These scratch the glass, which in turn could result in the glass cracking and shattering. • Do not allow grease to build up on the glass or become baked on as this reduces visibility into the oven.
<i>After every use</i>	<ul style="list-style-type: none"> • For stubborn stains, try using a mixture of baking soda and warm water with a non-abrasive scrubbing pad, then wipe dry with a soft, lint-free cloth. 	
Oven door gasket	<p>Avoid cleaning this part. If you need to remove large food particles off it, proceed as follows:</p> <ol style="list-style-type: none"> ① Dampen a sponge with clean hot water. ② Gently wipe off the soiling, but do not rub. ③ Press a dry towel gently on the gasket to dry. 	<ul style="list-style-type: none"> • Do not use any cleaning agent on the gasket. • The gasket is essential for a good seal. Take care not to rub, displace, or damage it.
Warming drawer (interior)	<ol style="list-style-type: none"> ① Wipe with a damp cloth and a solution of hot water and mild detergent. ① Wipe dry with a soft cloth. Note: the drawer may be removed to make cleaning easier. 	<ul style="list-style-type: none"> • To prevent soiling from becoming 'baked on' and stubborn, we recommend removing any easy-to-reach spills, food or greasy stains from the enamel after each use.
Drip tray under door (OR36 models only)	<ol style="list-style-type: none"> ① Remove oven door. ② Wipe with a damp cloth and a solution of hot water and mild detergent. 	

CARE AND CLEANING

WHAT? HOW OFTEN?	HOW?	IMPORTANT!
COOKTOP PARTS		
Aluminum and enamelled Burner caps and flame spreaders	<ol style="list-style-type: none"> ① Check that the burner is turned OFF and allow it to cool. ② Lift off the burner cap and brass flame spreader. ③ Wash them in hot soapy water, rinse, and dry. <ul style="list-style-type: none"> • Use a stiff nylon brush or straight-ended paper clip to clear the notches of the flame spreader. ④ Replace the flame spreader and burner cap correctly. See 'Replacing the burner parts'. <p style="margin-left: 20px;"><i>Brass burner parts only:</i> For extra shine and to remove tarnish use a suitable brass cleaner and polish, following manufacturer's instructions.</p>	<ul style="list-style-type: none"> • Keep the notches of the flame spreaders clear. Soiling may clog these and cause ignition problems. • Before replacing the burner parts, check that they are dry. Wet burner parts may result in an irregular flame. • Before lighting a burner you have reassembled, check that all of its parts are positioned correctly. Incorrect assembly can cause dangerous irregular flames and ignition problems. • Do not put any burner parts in the dishwasher as they will become discolored.
Ignitors	<ol style="list-style-type: none"> ① Check that the burner is turned OFF. ② Clean the ignitor with a small brush (eg old toothbrush) or cotton swab that has been dipped into rubbing alcohol. 	<ul style="list-style-type: none"> • The ignitors must be kept clean and dry to work correctly. Dirty or wet ignitors could cause constant clicking and sparking, even if a flame is present.
Burner grates	<ol style="list-style-type: none"> ① Wait until the grates have cooled completely. ② Carefully lift the grates off the cooktop and place them on a protected surface. ③ To remove stubborn stains, soak the grates in a mixture of clothes washing detergent and water. ④ Wash in a mixture of hot water and dishwashing liquid, then rinse and allow to dry. <ul style="list-style-type: none"> • The grates are also dishwasher safe. 	<ul style="list-style-type: none"> • Take care, the grates are heavy. • Make sure you place a dish towel or other soft cover on the surface before putting a grate on it.
Wok ring	<ol style="list-style-type: none"> ① To remove stubborn stains, soak the grates in a mixture of clothes washing detergent and water. ② Wash in a mixture of hot water and dishwashing liquid, then rinse and allow to dry. <ul style="list-style-type: none"> • The wok ring is also dishwasher-safe. 	

CARE AND CLEANING

Removing and replacing the oven door

IMPORTANT!

- Do not lift the oven door by its handle. Doing so may damage the door.
- Make sure the oven and the door are cool before you begin to remove the door.
- Before removing the door, make sure there is a large enough clear, protected surface in the kitchen to rest the door on.
- Take care, the oven door is heavy!

To remove the oven door

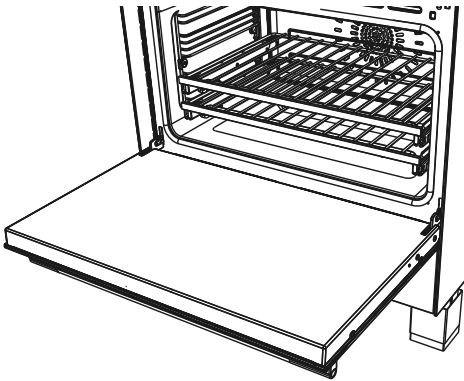

- ① Open the door fully.

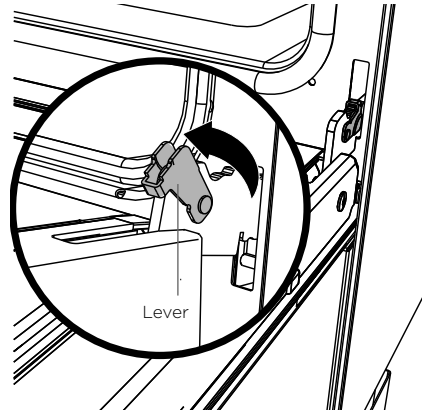

- ② Open the levers fully on both sides.

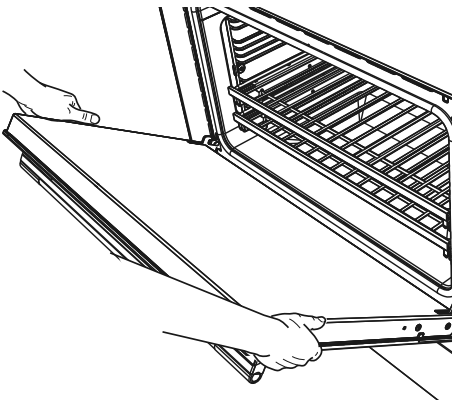

- ③ Holding the door firmly on both sides, gently close it about halfway.

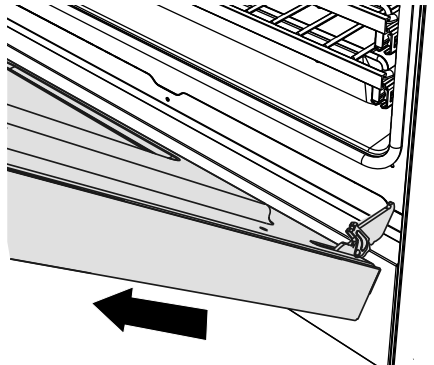

- ④ Disengage the hinges and remove the door. Place on a protected surface.

CARE AND CLEANING

To replace the oven door

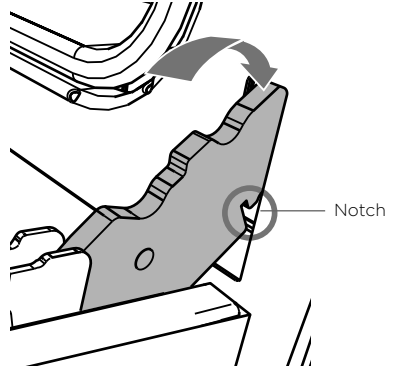
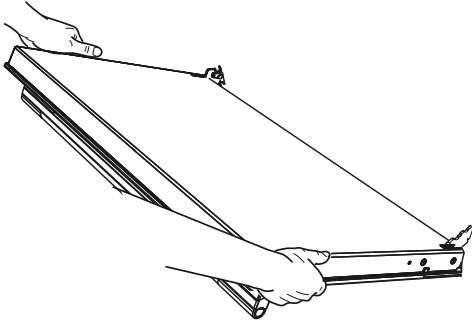

① Hold the door firmly in an approximately halfway open position.

② Insert the hinge tongues into the slots, making sure that the notches on both sides drop into place as shown.

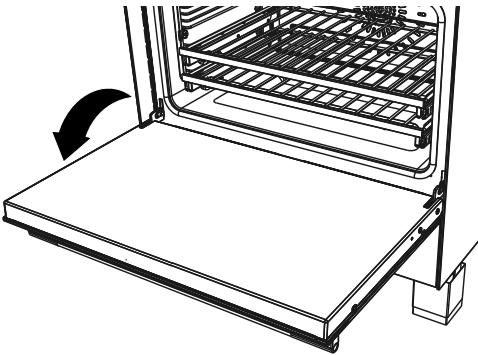

③ Open the door fully.

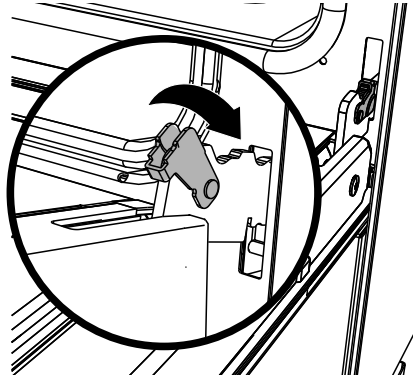

④ Fully close the levers on the left and right hinges, as shown, then close the door.

CARE AND CLEANING

Removing and replacing the oven side racks

IMPORTANT!

Always turn off the range at the wall first.
Ensure the oven has cooled down completely before starting.

Remove all shelves

- 1 Slide out all shelves and remove.
For easier access we recommend removing the oven door. See 'Removing and refitting the oven door'.

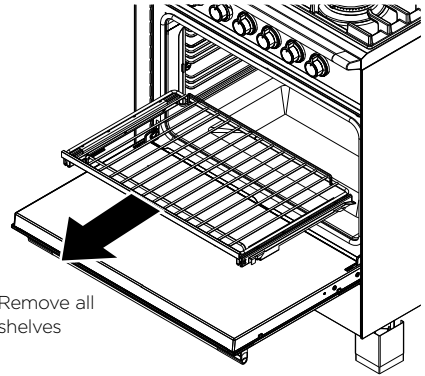

To remove the side racks

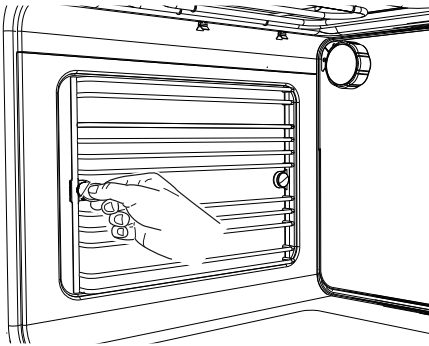

- 2 Use a small coin or a flat-head screwdriver to loosen and remove the fixing screws.

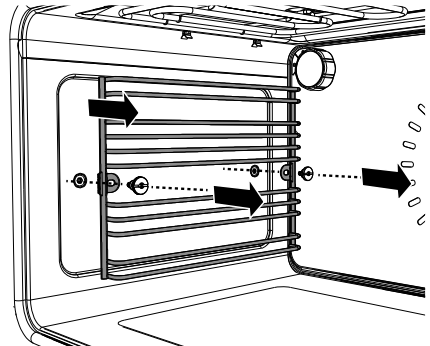

- 3 Remove the side racks.

To replace the side racks

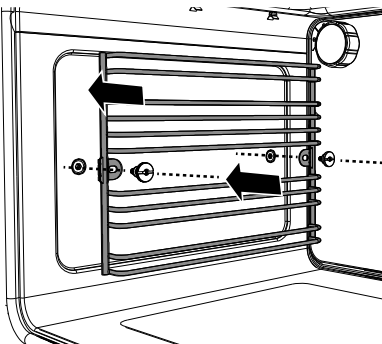

- 1 Make sure the side racks are the right way up, as shown.

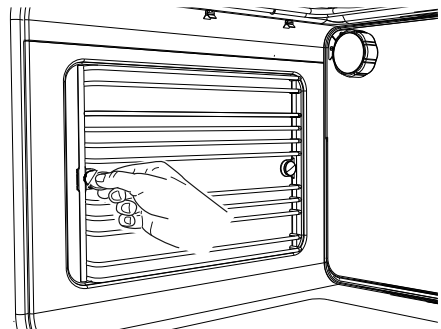

- 2 Refit the fixing screws and tighten.

Removing and replacing the warming drawer

IMPORTANT!

- Always turn off the range at the wall first.
- Ensure the oven and warming drawer have cooled down completely before starting.
- Ensure the drawer is completely empty before removing it.
- Always position your hand at the bottom of the drawer to open and close it.

To remove the warming drawer

- ① Open the drawer completely.
- ② Open the levers fully on both sides and hold in place:
 - On the left side push the lever down
 - On the right side push the lever up
- ③ Remove the drawer while holding the levers in position.

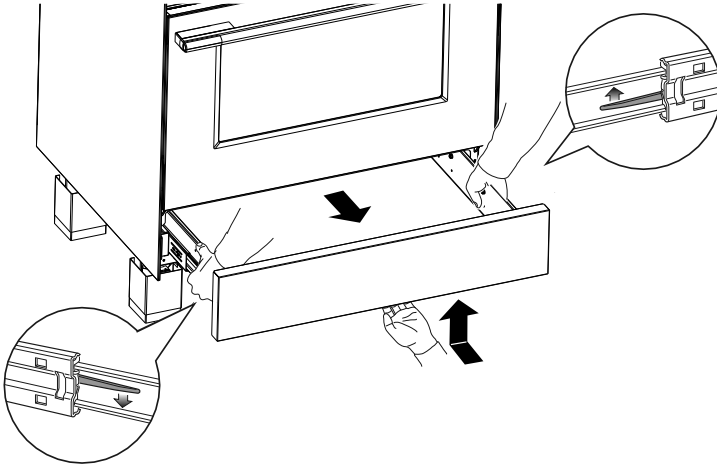

Fitting the warming drawer

- ① Insert the drawer guides onto the sliding runners on either side of the range interior.
 - Make sure they are correctly lined up on both sides of the drawer.
- ② Gently close the drawer completely. The safety catches will automatically hook into place.

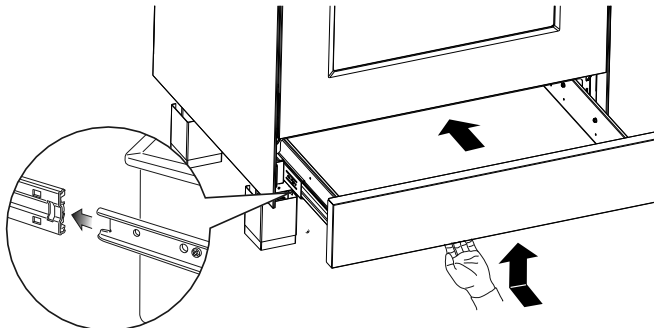

CARE AND CLEANING

Burner parts

- You can remove and clean these parts with hot soapy water or non-abrasive detergents. Clean spills regularly before they become burnt on. Do not wash these parts in a dishwasher.
- After cleaning, check that the burners and their flame spreaders are dry before replacing correctly.
- It is very important to check that the burner flame spreader and the cap have been correctly positioned. Failure to do so can cause serious problems.
- Check that the ignitor is always clean to ensure trouble free sparking. It must be cleaned very carefully using a toothbrush and methylated spirits.
- Note: to avoid damage to the electronic ignition, do not try to light a burner without all burner parts in place.

Replacing the burner parts

- Carefully replace the burner parts as per the following illustrations.
- Fit the flame spreader to the housing as shown below. Make sure the burner is not able to rotate.

Check that:

- the ignitor is always clean to ensure trouble-free sparking
- the probe is always clean to ensure correct operation of the safety valves
- the flame spreaders are clean and the holes are not clogged

Note: both the ignitor and probe must be very carefully cleaned using a toothbrush and methylated spirits.

Replacing the semi-rapid burners

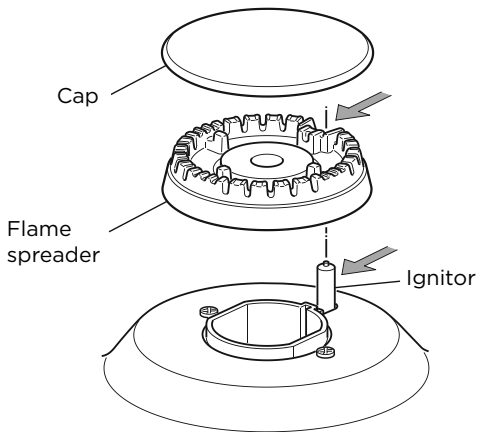

Correct positioning of semi-rapid burner parts

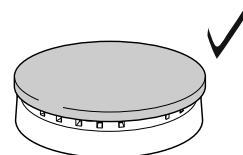
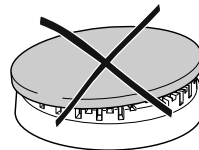
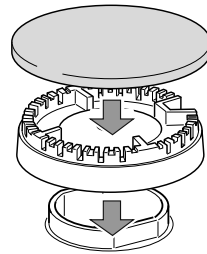

Replacing the semi-rapid burner caps

CARE AND CLEANING

Replacing the triple-ring wok and dual burners

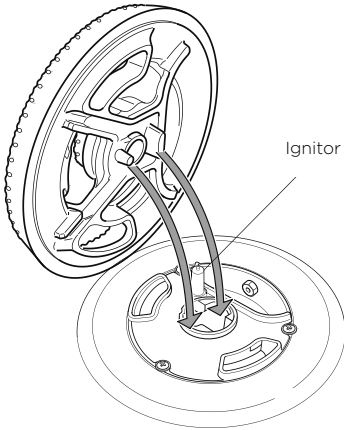

Correct positioning of flame spreader - triple-ring wok burner

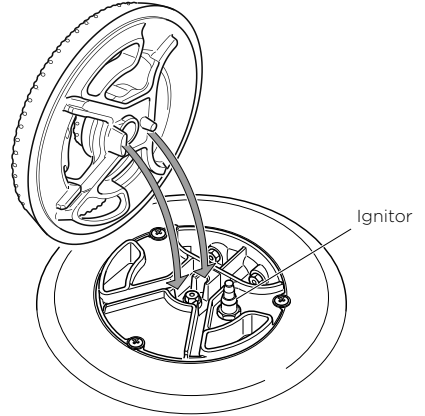

Correct positioning of flame spreader - dual burner

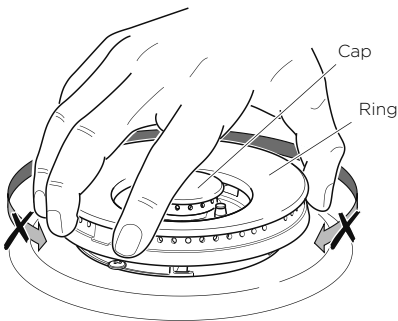

Correct positioning of cap and ring - triple-ring wok and dual burner

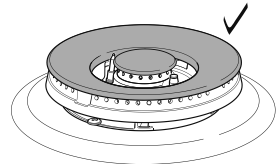
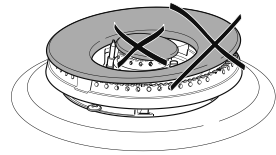
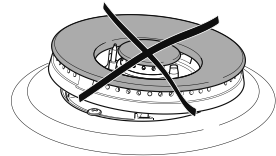

Incorrect and correct positioning of cap and ring - triple-ring wok and dual burner

CARE AND CLEANING

Replacing an oven light bulb

IMPORTANT!

Use a 25W, 120V 60HZ G9 halogen bulb for replacement.

Do not use a standard light bulb in any oven, the heat will break it.

- ① Allow the oven (including the lamp cover and the bulb) to cool completely.
- ② Remove any shelves that may get in the way.
- ③ Remove the door if the lamp will be hard to reach.
- ④ Turn the power supply to the range off at the main fuse or circuit breaker panel. If you don't know how to do this, contact an electrician.

IMPORTANT!

Failure to disconnect the range from the power supply may result in death or electrical shock.

- ⑤ Remove the lamp cover.
 - Upper lights: wearing a rubber glove to improve grip turn the cover counter-clockwise to unscrew.
 - Side lights: wearing a rubber glove to improve grip, hold the cover and prise out using finger nails on other hand. If this does not work place a thin plastic spatula between the cover and cavity wall and gently twist to prise the cover off. Take care not to chip the glass covers or to damage the enamel finish inside the oven.
- ⑥ Remove the faulty bulb.
- ⑦ Holding the replacement bulb in a soft cloth or tissue insert it into the socket. Do not touch the bulb with your fingers.
- ⑧ Replace the lamp cover.
 - Upper lights: turn the cover clockwise to tighten and then back a quarter turn.
- ⑨ Turn the power supply to the range back on at the main fuse or circuit breaker panel.

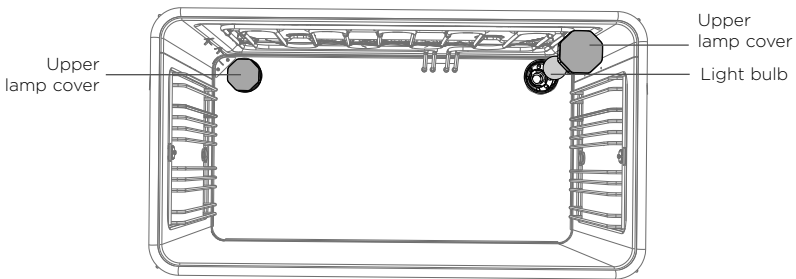

OR30 Models

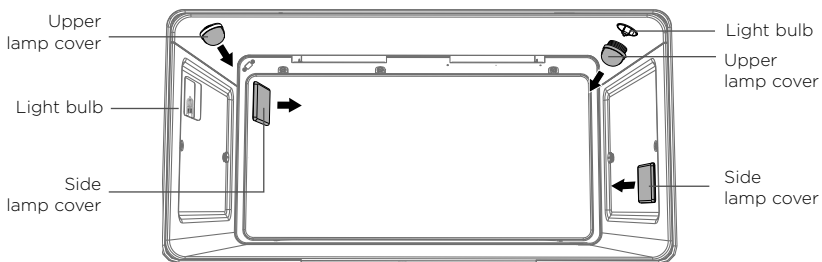

OR36 Models

USING THE SELF CLEAN FUNCTION

Using Self Clean

Self Clean uses extremely high temperatures to break down and burn off grease and grime. All that is left is a small amount of grey ash that you can easily wipe up.

There are two self clean cycles:

- **Standard Clean** 4 hours, for normal or heavy soiling
- **Light Clean** 3 hours, for light or localized soiling

IMPORTANT!

- **You must clean the inside glass door panel BEFORE starting a self-clean cycle. Failure to do this may result in permanent staining or marking of the door glass. See 'Care and cleaning' for our recommendations on how to do this.**
- **Do not use oven cleaners, any degreasing cleaners, or oven liners.**
- **Remove all oven shelves, trays, bakeware and utensils from the oven before starting a self clean cycle (except side racks). If left in the oven they will be permanently damaged; items made from combustible material (eg wood, fabric, plastic) may even catch fire.**
- **Do not use your oven to clean miscellaneous parts.**
- **Make sure the room is well ventilated.**
- **Before starting a Self Clean cycle, make sure you move any pet birds to another, closed and well-ventilated room. Some pet birds are extremely sensitive to the fumes given off during a Self Clean cycle, and may die if left in the same room as the oven during such a cycle.**
- **During a Self Clean cycle, the oven reaches higher temperatures than it does for cooking. Under such conditions, the surfaces may get hotter than usual and children should be kept away.**
- **The oven door will be locked during the Self Clean cycle.**
- **If there are cracks or flaws on any of the oven door glass panes, if the oven seal is damaged or worn, or if the door does not close properly, do not start a Self Clean cycle. Call your Fisher & Paykel trained and supported service technician.**

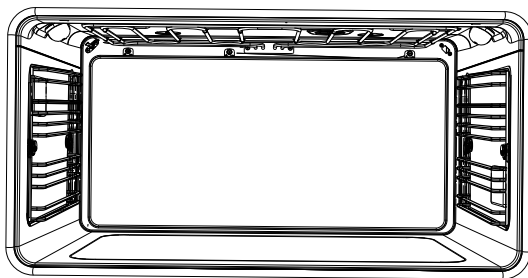

Before you start

- ① Remove all oven shelves and any other accessories, bakeware, and utensils.
Note: you do not need to remove the side racks.
- ② Wipe up any spills, and along the inner edge of the oven surface around the seal. Failure to do so may discolour the oven surface.

IMPORTANT!

Avoid cleaning the seal itself as this may cause damage.

- ③ Check the inner glass pane of the oven door. If it has soiling on it (eg stains from greasy splatter), you will need to clean it manually before starting a Self Clean cycle. For instructions, see 'Care and cleaning'.

IMPORTANT!

- **If soiling is left on the glass, it will become burnt on during the Self Clean cycle, making it very difficult to remove.**
- ④ Close the oven door firmly.

USING THE SELF CLEAN FUNCTION

To set Self Clean

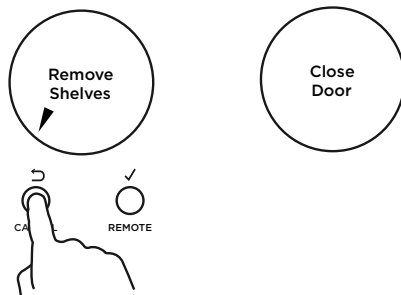
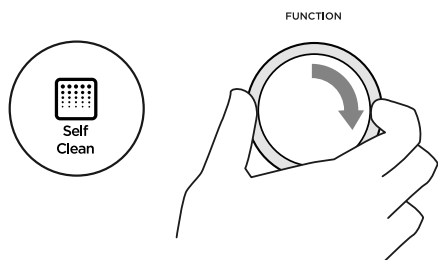

① Turn the function dial to Self Clean.

- ② The display will prompt you to remove the oven shelves.
- Remove the oven shelves and any other bakeware or accessories still in the oven.
 - Press and hold ↵ to confirm.
 - If the oven door is not closed properly, the display will also prompt you to close the door.

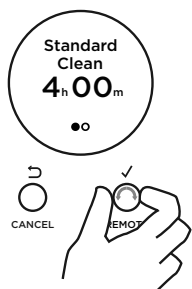

③ Scroll to choose between Standard Clean and Light Clean.

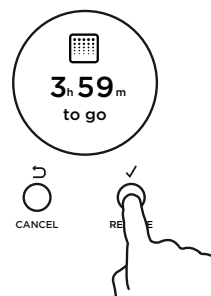

④ Press ✓ to confirm.

Self Clean is now set.

- The door will automatically lock and remain locked during the cycle.
- The display will start counting down the time remaining.

USING THE SELF CLEAN FUNCTION

When Self Clean is finished

- A tone will sound.
 - Self Clean Complete will show in the display.
 - The display will flash.
 - The door will unlock.
- ① Press any button to stop the display flashing.
 - ② Wait for the oven to cool completely.
 - ③ Wipe up the ash in the oven with a small brush or a damp cloth.
 - ④ Dry with a lint-free cloth.
 - ⑤ Replace the oven shelves.



To cancel Self Clean

IMPORTANT!

- **A Self Clean cycle can be cancelled at any time.**
- **The door will not unlock until the oven has cooled to a safe temperature.**
- **Do NOT turn off the mains power supply to the oven (wall switch). Turning off the power while the oven is too hot may damage the oven and its surrounding cabinetry.**

- ① Press  to cancel Self Clean.
- Self Clean Cancelled will show in the display.
 - The door will remain locked and the display will remain lit until the oven has cooled down to a safe temperature.

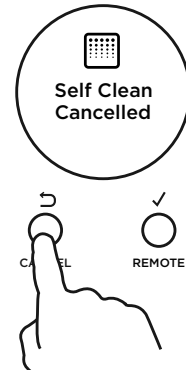

TROUBLESHOOTING

Troubleshooting chart

If there is a problem, check the chart below to see if you can fix it. If the problem cannot be fixed or persists, call your Fisher & Paykel trained and supported service technician or Customer Care.

PROBLEM	POSSIBLE CAUSES	WHAT TO DO
General		
The oven does not work.	No power.	Check that the mains power supply (wall switch) is turned on, the fuse has not tripped and there is no power outage in your area.
	The clock has not been set.	The oven will not work unless the clock is set. See 'Setting the clock'.
The oven does not work but the display is lit.	The oven is set for automatic cooking.	See 'Automatic cooking' for instructions.
	The oven is in Demo Mode.	Contact Customer Care.
One or all of the lights do not come on, but the oven works.	The oven light bulb(s) have blown.	Replace the light bulb(s). See 'Care and cleaning' for instructions.
	The door is not correctly fitted.	See 'Care and cleaning' for instructions on fitting the door correctly.
	The oven is in Sabbath setting and the 'Light off' option has been saved.	To quit Sabbath setting, press and hold CANCEL. See 'User preference settings' for instructions on changing the 'Light off' option.
The temperature indicator is blank and the oven control dials are unresponsive.	The control panel is locked.	See 'Locking the oven controls' for instructions.
The oven is not heating.	The door is not properly closed or it is opened too frequently during cooking.	The heating elements are disabled while the door is open. Make sure the door is properly closed and avoid opening it frequently during cooking.
A glass pane in the oven door has cracked, chipped, or shattered.	Incorrect cleaning or the edge of the glass hitting against something.	You must NOT use the oven. Call your Fisher & Paykel trained and supported service technician or Customer Care.

TROUBLESHOOTING

PROBLEM	POSSIBLE CAUSES	WHAT TO DO
General		
I can feel hot air blowing out of the vents after I have turned the oven off.	This is normal.	For safety reasons the cooling fans will continue to run even when you have turned the function dial to 'OFF'. The fans will switch off automatically when the oven has cooled.
The oven fan comes on when I select a function that does not use a fan (eg bake or classic bake).	This is normal. The fan comes on while the oven is preheating. It may turn off when the oven has reached the set temperature.	Wait until a long tone sounds and the temperature dial halo turns white: the oven will then be ready to use.
The oven has reached the set temperature but the temperature dial halo is still red (indicating that the oven is not ready to use).	This is normal: when heating up from cold, your oven is designed to initially heat to a temperature somewhat higher than what you have set. This is to provide optimal baking conditions right from the start.	Wait until a long tone sounds and the temperature dial halo turns white: the oven will then be ready to use.
The oven is heating but the display is dark.	The oven is set to 'Display off' option. The oven is in Sabbath setting.	To quit the 'Display off' option, press and hold CANCEL until the display shows the time of day. To quit Sabbath setting, press and hold CANCEL until the display shows the time of day.
The oven cancels automatic cooking when I try to adjust the clock setting.	The oven was set for automatic cooking when you were trying to adjust the clock setting.	You can only adjust the clock setting while the oven is not set for automatic cooking.
The temperature dial halo never turns red when I use Maxi Broil.	This is normal: the halo stays white to indicate that the broil element provides instant radiant heat.	
The displays work, and the function and temperature dials halos come on but the oven does not heat up.	The oven is in 'Demo' mode.	Call Customer Care.

TROUBLESHOOTING

PROBLEM	POSSIBLE CAUSES	WHAT TO DO
Self Clean function		
During a Self Clean cycle, the oven is louder than usual.	This is normal: the oven's cooling fans operate at their highest speed.	
The Self Clean cycle has finished, but the oven door will not open.	The oven door is locked because the oven is still too hot to be used for cooking.	Wait until the Self Clean cycle has finished. If you cancelled a Self Clean cycle which was already underway, the oven still needs to cool down before it can be used. The oven door will automatically unlock.
I have cancelled a Self Clean cycle but cannot use the oven: <ul style="list-style-type: none"> • the oven door will not open • the display is still counting down minutes or showing Self Clean Canceled • the dials and controls are unresponsive. 	This is normal: if the function dial halo is unlit, you have successfully cancelled the Self Clean cycle. However, the oven is still too hot to be used for cooking and needs to cool down.	Wait until the cool-down phase has finished. A long tone will sound and the oven door will automatically unlock when the oven is ready to use. Note: depending on when the Self Clean cycle was cancelled, the cool-down phase may take up to 45 minutes.
The oven is beeping and the display shows $\overline{A2}$ or $\overline{A3}$.	See section 'Alert codes' for instructions.	
There is a power cut during a Self Clean cycle.	Power cut.	The door will remain locked. Once the power is turned back on, the door will remain locked until the oven has cooled to a safe temperature.

TROUBLESHOOTING

PROBLEM	POSSIBLE CAUSES	WHAT TO DO
OVEN		
Condensation around oven (eg on control panel or top of oven door.)	Food has high moisture content or local climate (temperature, humidity) is contributing to condensation.	Condensation is normal. You can wipe the drops off the control panel. If there is frequent or excessive condensation, make sure that cabinetry around the range is moisture-proofed.
Condensation building up in the oven while cooking on Maxi Broil.	Food in your oven releasing moisture as it cooks.	Allow the broil element to preheat for 5 minutes before placing food in the oven or try cooking on Aero Broil instead.
Steam coming from oven vents at the back of the range.	Moisture from food evaporating during cooking.	This is normal, especially if you are cooking large quantities of food in the oven using the Aero Bake function.
Uneven baking.	Oven not properly preheated.	Wait until the halo around the temperature knob has changed from red to white before putting food in.
	Unsuitable or incorrectly arranged bakeware.	See 'Oven cooking guidelines' for advice.
COOKTOP BURNERS		
None of the burners, grill, or griddle will light.	No power supply.	Check that there is no power outage in your area and that the power supply to the range is switched on at the circuit breaker panel.
	No gas.	Check that the gas supply to the house is working. You should hear the gas when you turn a burner on. If you are using bottled gas, check that it is not empty.
The ignitor keeps clicking (continuous spark) even when a burner has lit.	Dirty or wet ignitor(s).	Clean the ignitor(s). See 'Care and cleaning' for instructions.

TROUBLESHOOTING

PROBLEM	POSSIBLE CAUSES	WHAT TO DO
COOKTOP BURNERS		
Some burners will not light.	Burner parts or ignitors may be wet, dirty, or misaligned.	Check that the burner parts are clean, dry, and correctly assembled. Check that the ignitors are clean and dry. See 'Care and cleaning' for instructions.
Flames do not burn all around the burner cap.		
There is no clicking when I try to light a burner.	The ignitor is dirty or there is a power outage.	Clean the ignitor(s). See 'Care and cleaning' for instructions.
There is a power failure - can I still use the cooktop burners?	Power outage in your area.	The cooktop burners can still be used. To light them: <ol style="list-style-type: none"> ① Holding a lighted match to the flame spreader, push in on the control knob and turn counterclockwise to LITE. ② When the flame is burning all the way around the burner, you may adjust the heat.
IMPORTANT!		
If the flame is blown out during a power failure, turn the knob immediately to O (OFF), as the burner will not automatically relight and gas may escape.		
The flames have suddenly gone out.	A draft or a spill has extinguished the flame.	No action required. The burner will detect this and automatically relight. However, if there has been a large spill, we recommend turning the burners off and cleaning the burners and sump area. See 'Care and cleaning' for instructions.
There is a slight 'extinction pop' or flash after I've turned a cooktop burner off.		This is normal for LP gas and requires no action.
The burner flames are uneven, very large, yellow or yellow-tipped or sooty.	Technical fault: the gas is the wrong type or hasn't been adjusted properly.	Do not use your cooktop burners. Contact your Fisher & Paykel trained and supported service technician or Customer Care.

ALERT CODES

If there is a problem with the oven, the range will:

- automatically suspend all oven functions
- beep five times
- display an alert code.

IMPORTANT!

Do not turn off the mains power supply to the range (wall switch) if you get an alert code, unless the instructions in the chart following specifically instruct you to. There are cooling fans within the range which are needed to cool the range components. Turning off the power while the range is too hot may damage the range and its surrounding cabinetry.



What to do if an alert code is displayed

- ① If the beeping hasn't stopped already, touch any control to stop it.
- ② Make a note of the alert code displayed. You may need this information.
- ③ Check the chart following to see if you can fix the problem yourself and follow the instructions.
- ④ If you can fix the problem and the alert code does not reappear, you can keep using your oven.

OR

If you can't fix the problem yourself or the alert code reappears and the problem persists: wait until the cooling fans have stopped and the oven has completely cooled down, then turn the power to the range off at the wall and call your Fisher & Paykel trained and supported service technician or Customer Care with the alert code information.

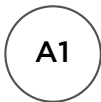
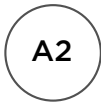
ALERT CODES

ALERT CODE	POSSIBLE CAUSES	WHAT TO DO
 A1	The oven has overheated.	<ol style="list-style-type: none"> ① Allow the oven to cool down. ② Once the oven has cooled down and the door has unlocked, the alert code will disappear. You can now use the oven again.
 A2	Door lock error: the door cannot be locked after you have started a Self Clean cycle.	<ol style="list-style-type: none"> ① Turn the power to the oven off at the wall and on again. ② Wait approximately 10 seconds. This is to allow the door lock to return to its initial position. ③ Set the clock. See 'Setting the clock and first use' for instructions. ④ Try starting a Self Clean cycle again, making sure that you close the door firmly. See 'Using the Self Clean function'.
 A3	Door lock error: the door cannot be unlocked after a Self Clean cycle has finished.	<ol style="list-style-type: none"> ① Turn the power to the oven off at the wall and on again. ② Try touching on the oven door to help the door lock disengage. ③ If this doesn't help and the alert code reappears, call your Fisher & Paykel trained and supported service technician or Customer Care.
 F2 F + number	Technical fault.	<ol style="list-style-type: none"> ① Note down the alert code. ② Wait until the cooling fans have stopped and the oven has completely cooled down. ③ Turn the power to the oven off at the wall. ④ Call your Fisher & Paykel trained and supported service technician or Customer Care with the alert code information.

WARRANTY AND SERVICE

Before you call for service or assistance

Check the things you can do yourself. Refer to the installation instructions and your user guide and check that:

- ① Your product is correctly installed.
- ② You are familiar with its normal operation.

If after checking these points you still need assistance or parts, please refer to the Service & Warranty book for warranty details, contact your nearest Fisher & Paykel service center, Customer Care, or get in touch via our website www.fisherpaykel.com.

Complete and keep for safe reference:

Model _____

Serial No. _____

Purchase Date _____

Purchaser _____

Dealer _____

Suburb _____

Town _____

Country _____

FISHERPAYKEL.COM

© Fisher & Paykel Appliances 2021. All rights reserved.

The models shown in this guide may not be available in all markets
and are subject to change at any time.

The product specifications in this guide apply to the specific products and
models described at the date of issue. Under our policy of continuous product
improvement, these specifications may change at any time.

For current details about model and specification availability in your country,
please go to our website or contact your local Fisher & Paykel dealer.

591500D 03.21