

**FISHER & PAYKEL**

**FRONT LOADING  
WASHER DRYER**

---

WD8560F1, WD7560P1 & WD8060P1 models

**INSTALLATION GUIDE / USER GUIDE**

**NZ AU GB**



# CONTENTS

---

Introduction	3
Safety and warnings	4
Installation instructions	11
Before you do your first wash	17
Safety features	18
Washer dryer controls	19
Wash and dry cycles	21
Detergent and fabric softener	23
Wash preparation	26
Getting started quickly	30
Customising wash and dry cycles	36
Caring for your washer dryer	37
Before you call for service	40
Fault codes	42
Troubleshooting	43
Consumption data table	51
Product Fiche according to Commission Delegated Regulation (EU) 96/60/EC	52
Manufacturer's Warranty	53
Customer care	55
European Directive 2012/19/EU on Waste Electrical and Electronic Equipment (WEEE)	57

---

## **IMPORTANT!**

### **SAVE THESE INSTRUCTIONS**

The models shown in this user guide may not be available in all markets and are subject to change at any time. For current details about model and specification availability in your country, please go to our website [fisherpaykel.com](http://fisherpaykel.com) or contact your local Fisher & Paykel dealer.

## **Registration**

Register your product with us so we can provide you with the best service possible.

To register your product visit our website: [fisherpaykel.com](http://fisherpaykel.com)



# INTRODUCTION

---

## Welcome

Thank you for buying a Fisher & Paykel washer dryer. We are proud of this washer dryer and trust it will serve you well for many years.

Your washer dryer gives you the ultimate convenience in one simple machine. There are numerous wash, dry and continuous wash and dry cycles with additional options, meaning you can perform every wash and dry task with ease and have the knowledge that your clothes are receiving the best possible care.

With the ability to automatically sense when your clothes are dry, your washer dryer is more efficient, making it kinder on your wallet and the environment. Having the technology of a water condensing dryer allows clothes to be dried in a closed environment where the hot moist air is condensed and pumped directly into a drain, therefore requiring no external ventilation.

At Fisher & Paykel we aim to provide innovative products that are simple to use, ergonomic and that will exceed expectations. Thousands of tonnes of laundry and 80 years of experience have been programmed into your washer dryer to help give you the best possible performance.

Please take the time to read these instructions carefully before you begin using your machine. Following the advice in this user guide will ensure you get the performance you expect from your machine with the best possible wash and dry results. Keep these instructions for future reference.

We hope you enjoy your new washer dryer. We have certainly enjoyed designing it for you.

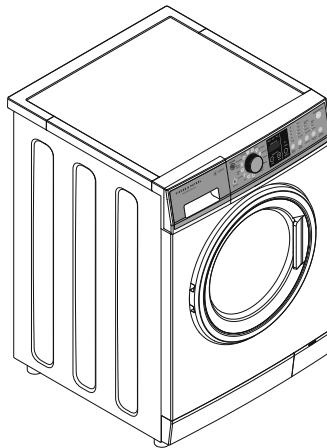

Front loading washer dryer



**Caution, risk of fire — this is a safety symbol. Failure to follow the warnings outlined in these user instructions can cause a fire hazard.**

**⚠ WARNING!**



**Fire Hazard**

- Only dry fabrics that have been washed with water.
- Do not use heat to dry articles containing foam rubber or similarly textured rubber-like materials, dry on 'Air Dry'.
- Do not stop a washer dryer before the end of the drying cycle unless all items are removed and spread out in order to dissipate the heat.
- A washer dryer produces combustible lint; clean pump filter regularly.
- Failure to follow these instructions can result in death or personal injury.

**⚠ WARNING!**



**Electric Shock Hazard**

**If you are using an extension cord or a portable electrical outlet device (eg multi-socket outlet box), ensure that it is positioned so that it does not come into contact with water or moisture. Failure to do so may result in death or electrical shock.**

- This product has been designed for personal, family or household use. This product is not designed for any commercial use. Any commercial use will terminate this products manufacturer’s warranty.

## IMPORTANT SAFETY INSTRUCTIONS

### WARNING!

When using your washer dryer, follow basic precautions, including the following:

#### General

- Do not overload your machine beyond its rated capacity.

MAXIMUM CAPACITY	kg	kg	kg
Wash capacity	7.5	7.0	8.5
Dry capacity	4.0	4.0	5.0

- **CAUTION:** In order to avoid a hazard due to inadvertent resetting of the thermal cut-out, this appliance must not be supplied through an external switching device, such as a timer, or connected to a circuit that is regularly switched on and off by the utility.
- This washer dryer is not intended for use by persons (including children) with reduced physical, sensory or mental capabilities, or lack of experience and knowledge, unless they are supervised or given instructions on how to use the washer dryer by someone responsible for their safety.
- The washer dryer should only be used for washing, rinsing and drying of textiles where this is indicated on the care label.

- **The door will be locked from the start of the cycle until the cycle is complete for safety reasons. It is possible to open the door during the cycle under certain conditions (refer to page 20).**
- **Never force the door open.**
- **Keep children away from the washer dryer while it is in operation.**
- **Supervise children to ensure they do not play with the washer dryer or climb inside the drum.**
- **Do not touch the door during a drying cycle as the door can become hot.**
- **Do not open the detergent dispenser during the cycle.**
- **The only user-removable parts of the washer dryer are the inlet hose, detergent dispenser and the pump filter. No other parts are designed to be removed by anyone other than a Fisher & Paykel trained and supported service technician.**
- **Do not touch or operate the machine with wet hands or with bare-feet.**
- **A damaged power cord must be replaced by a Fisher & Paykel trained and supported service technician, in order to avoid a hazard. The appliance must not be operated until it is repaired, as there is a risk of electric shock.**
- **Do not operate this machine if it has been damaged during transport. Contact your Fisher & Paykel dealer or Fisher & Paykel trained and supported service technician.**
- **Do not add gasoline, dry-cleaning solvents, or other flammable or explosive substances to the wash water. These substances give off vapours that could ignite or explode.**



- **Do not wash or dry articles that have been previously cleaned in, washed in, soaked in, or spotted with gasoline, dry-cleaning solvents, or other flammable or explosive substances as they give off vapours that could ignite or explode.**
- **Undergarments that contain metal reinforcements should not be placed in the washer dryer. Damage to the machine can result if the metal reinforcements come loose during washing or drying.**
- **Check and remove all objects from pockets, eg lighters and matches.**
- **Never wash or dry rubber articles, fibreglass, or any plastic items or film, eg plastic lined tablecloths and baby bibs.**
- **Clothes must go through the cool down/airing phase in the final part of the drying cycle. This ensures items are left at a temperature where they will not be damaged. If for any reason the washer dryer is stopped before the cycle has finished, dry clothes should be removed immediately and not left in the dryer. Clothes should be quickly spread out flat to cool so heat can dissipate, not left bunched up, eg in a clothes basket.**
- **This washer dryer has been designed for domestic use only, not for commercial applications, such as massage/beauty clinics where there may be increased lint accumulation or flammable materials in the atmosphere or load.**
- **Do not operate this product if there is an accumulation of lint in or around the washer dryer.**
- **Children should be supervised to ensure they do not play with the washer dryer.**

- **Unplug the machine from the power supply when it is not in use.**
- **Do not swing or put weight on the door.**
- **Your washer dryer is designed to stop operating in the event of power outage. When power is resumed, the machine will remain off until the 'POWER' button is pressed. To restart the washer dryer, press 'POWER', select your wash or drying cycle and touch ▶||.**
- **Never attempt to repair the washer dryer yourself.**
- **For problems that cannot be solved from information in this user guide, turn off and unplug your washer dryer and contact a Fisher & Paykel trained and supported service technician.**

### **Spontaneous combustion**

#### **IMPORTANT!**

**To reduce the risk of fire in a washer dryer the following should be observed:**

- **Items that have been spotted or soaked with vegetable oil or cooking oil are a fire hazard and should not be placed in a tumble washer dryer.**
- **Oil-affected items can ignite spontaneously, especially when exposed to heat sources such as a washer dryer. The items become warm causing an oxidation reaction in the oil. This oxidation creates heat. If the heat cannot escape the items can become hot enough to catch fire. Piling, stacking or storing oil-affected items can prevent heat from escaping creating a fire hazard.**

## SAFETY AND WARNINGS

---

- **Fabrics that contain vegetable oil, cooking oil or have been contaminated by hair care products should not be washed or dried. If unavoidable, these fabrics should be washed in a hot water wash with extra detergent – this will reduce, but not eliminate the fire hazard. The cool down cycle of the washer dryer should be used to reduce the temperature of these items. They must not be removed from the washer dryer and piled or stacked while hot.**
- **Items that have previously been cleaned in, washed in, soaked in or spotted with flammable liquids or solids, eg petrol/gasoline, kerosene, dry cleaning solvents, vegetable or cooking oil, acetone, denatured alcohol, some brands of spot removers, turpentine, waxes and wax removers or other flammable or explosive substances should not be placed in a washer dryer.**
- **Do not dry unwashed items in the washer dryer.**
- **Fabric softeners, or similar products, should be used as specified by the fabric softener instructions.**
- **The washer dryer must not be used if industrial chemicals have been used for cleaning.**

### Installation

- The washer dryer must be installed in a well-ventilated, dust-free environment.
  - The washer dryer must not be installed on any textured floor coverings (eg carpet, rugs) to ensure that openings at the base of the machine are not obstructed.
  - Do not install the washer dryer behind a lockable door, sliding door, or behind a door where the hinge is on the opposite side to that of the washer dryer in such a way that the full opening of the door is inhibited. Ensure the washer dryer door can always be opened fully.
  - The cold water temperature should not exceed 35°C.
- Water supply requirements:**
- Inlet water pressure: Maximum 1MPa (150psi), Minimum 30kPa (4.5psi)
  - Inlet water flow rate: Minimum 6 litres/minute
  - A new hose is provided with the washer dryer and should be used to connect the washer dryer to the water mains.
  - Old hoses should not be re-used.
  - We recommend that the inlet hose be changed every 5 years. Failure to do so may result in a flood and damage to property.

### Disposal

- When disposing of the washer dryer, it is recommended that the door is removed to avoid children getting trapped inside, and that the electrical cable is cut off close to the washer dryer.

# INSTALLATION INSTRUCTIONS

**Please read and follow the ‘Safety and warnings’ and ‘Installation instructions’ sections carefully before using your washer dryer!**

## Accessories

Please check you received the following accessories with your Fisher & Paykel washer dryer. You will find them inside the drum:

- 1 x Inlet hose
- 1 x Drain hose guide
- 1 x Installation instructions and user guide
- 1 x Spanner
- 1 x Installation leaflet (attached to the top of the washer)
- 1 x Hose clamp (WD8060P1 model only)

## Unpacking

To ensure the best performance from your new washer dryer please follow the instructions below.

### Removing the packaging

- ① Remove the outer packaging (including the polystyrene packer and plastic wrapping). All packaging must be removed prior to use. Ensure these materials are kept out of reach of children. Note: a small amount of water may be seen inside the packaging and inside the washer dryer. This is the result of factory testing and is normal.
- ② Tilt the product backwards and ‘walk’ it off the base one foot at a time. Not doing so may cause damage to your floor and washer dryer.
- ③ Remove all packaging and accessories from inside the drum.

### Removing the transit bolts

The clothes washer dryer is fitted with 4 transit bolts at the rear to prevent internal damage during transportation.

**The 4 transit bolts MUST be removed prior to operation of the machine. Failure to remove these will result in damage to the machine and compromise your manufacturer’s warranty.**

# INSTALLATION INSTRUCTIONS

## To remove the bolts:

- ① Use a spanner or socket to unscrew and remove all four transit bolts at the back of the washer dryer (**A**).
- ② Pull the black rubber grommets to remove the bolt, grommet and white plastic spacers from the machine. Keep the transit bolts in case they are required for future transit of the machine. **Never transport the machine without the transit bolts properly fixed in place.**
- ③ Cover the bolt holes with the white plastic plugs which are attached to the machine and located near each hole (**B**). Push to clip into place.

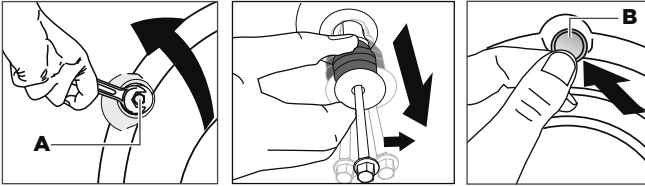

Removing the transit safety bolts

## Installation location

This washer dryer CANNOT BE INVERTED AND MOUNTED ON THE WALL.

# INSTALLATION INSTRUCTIONS

## Product dimensions

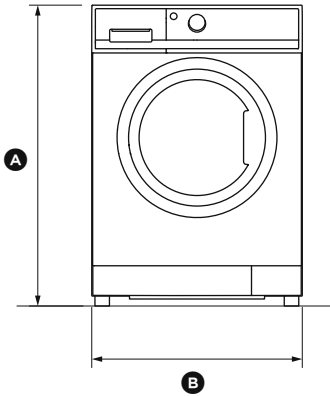

**FRONT VIEW**

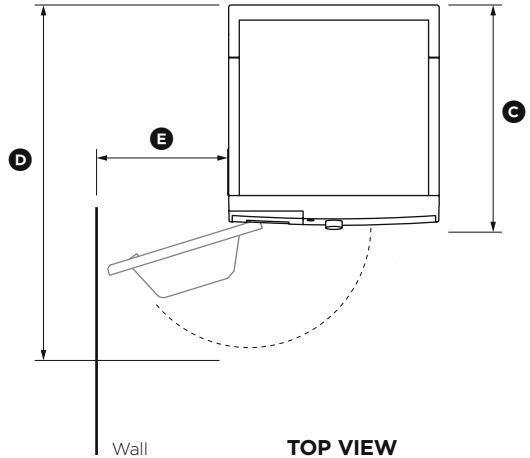

**TOP VIEW**

	<b>WD7560P1</b>	<b>WD8060P1</b>	<b>WD8560F1</b>
<b>PRODUCT DIMENSIONS</b>	<b>mm</b>	<b>mm</b>	<b>mm</b>
(A) Overall height of product	850	850	850
(B) Overall width of product	600	600	600
(C) Overall depth of product (including dial and door when closed)	590	590	645
(D) Depth with door open	1010	1010	1065
(E) Minimum door clearance to adjacent wall	330	330	330
Standpipe height	min. 800-1200	min. 800-1200	min. 800-1200
<b>MAXIMUM CAPACITY</b>	<b>kg</b>	<b>kg</b>	<b>kg</b>
Wash capacity	7.5	7.0	8.5
Dry capacity	4.0	4.0	5.0

Note: the exact height of your washer dryer is dependent on how far the feet are extended from the base of the machine. The space where you install your washer dryer needs to be at least 40mm wider and 20mm deeper than its dimensions.

# INSTALLATION INSTRUCTIONS

This machine must not be installed and operated on a plinth.

## Levelling the machine

It is IMPORTANT to level the machine to ensure good spin performance, and to minimise noise, vibrations and wear and tear on the washer dryer.

- 1 Before positioning the machine in its final position, check that the machine is level, front to back and side to side.
- 2 Manoeuvre the product into its final position (we suggest a minimum clearance of 20mm each side).
- 3 Use a spirit level to check that the machine is correctly level. The washer dryer comes with four adjustable feet, wind all four feet up or down until the dryer is correctly level. Place the spirit level on top of your washer dryer in the following places;
  - left to right
  - back to front
  - corner to corner.

The machine is considered level when the bubble sits in the centre of the two lines when placed flat on top of the machine.

- 4 Using the spanner provided, tighten the lock nuts against the base of the machine to lock the feet in position.

Never unscrew the feet completely from their housings.

After levelling, the corners of the washer dryer cabinet should be clear of the floor and the machine must not rock in any direction.

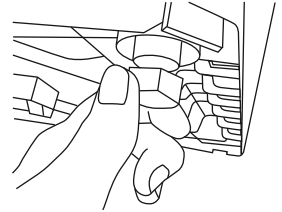

Levelling the feet

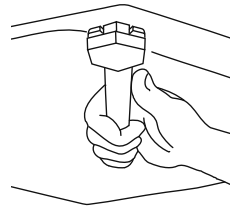

Locking the feet

## Connecting to the water supply

### Inlet hose

- 1 Connect the straight end of the inlet hose to the cold tap and the elbow end to the machine inlet valve. Tighten the inlet hose end by hand until the hose seal just makes contact with the tap sealing face and then tighten a further half-turn. Make sure there are no kinks in the hose.
- 2 Turn the tap on and check for leaks. Check for leaks again after 24 hours.

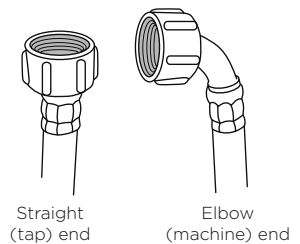

Inlet hose ends

Note: an internal heater in the product will heat the cold water to the selected cycle temperature.



# INSTALLATION INSTRUCTIONS

## Draining

### Drain hose placement in a stand pipe or tub

- ① To guide the drain hose over the tub or standpipe the hose guide must be fitted to the drain hose. The height of the standpipe or tub should be between 800 - 1200mm.
  - ② Secure the hose guide so it cannot become dislodged from the standpipe or tub.
- If the drain hose is placed on the ground or if the standpipe or tub is less than 800mm high, the machine will continuously drain while being filled (siphon).
  - Regularly check that your standpipe or tub is free from lint or other obstructions, which may affect how your machine works or may cause flooding.

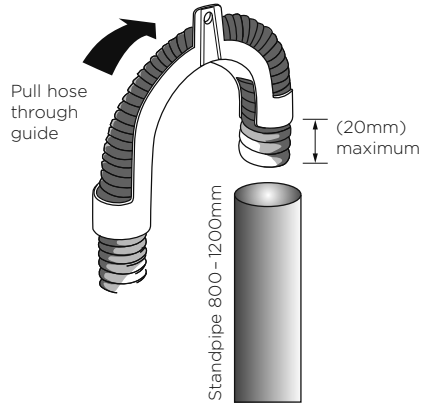

Fitting the drain hose guide

### Attaching drain hose to spigot

- ① Guide drain hose through hose guide
  - ② Secure hose guide to back wall of cupboard using a screw. The height of the drain hose should be between 500 - 800mm from ground level.
  - ③ Attach drain hose to spigot and secure using a hose clamp ensuring the blanking insert is cleared from spigot.
  - ④ Check for leaks.
- The drain hose should be checked from time to time and replaced if any damage (eg wear, cuts, bulges, kinks, leaks, etc) is found. Do not bend the drain hose sharply, as this may cause it to split.
  - In multi-storey apartments or any upper floor, the machine should be installed on a floor equipped with a drain.
  - Draining must comply with local by-laws.

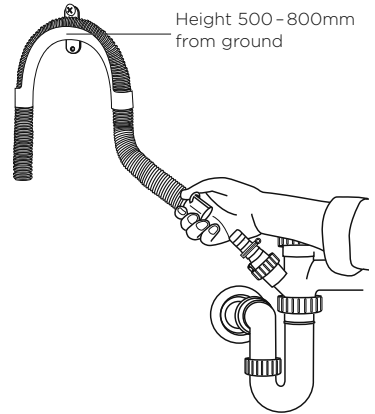

Attaching drain hose to spigot

# INSTALLATION INSTRUCTIONS

## Electrical connection

- ① This appliance must be connected to a 220V – 240V, 50Hz, sinusoidal, minimum 10A electrical supply.
  - ② Uncoil the power cord, remove and discard the plastic pin cover and plug into a wall socket.
  - ③ Connect the appliance to an earthed outlet protected by a fuse of suitable capacity.
- Check the power cord for damage and make sure it is not squashed or twisted when installing the washer.
  - Always remove the power cord from a socket by the plug, not by the cord.

---

## SPARE PARTS

---

Available from your Fisher & Paykel dealer or a Fisher & Paykel trained and supported service technician.

Hose Inlet Long (2m)	Part No. 422680P
Hose Inlet Large Bore	Part No. 426123P
Drain Hose Extension (not suitable for attaching to a spigot)	Part No. 425627P

## Completing the installation

### Installation test cycle

**Do this before you wash or dry any items in your washer dryer. This is to check that your washer dryer is installed and functioning correctly prior to use.**

- ① Turn your washer dryer on by pressing the 'POWER' button.
- ② Select the 'Quick Wash 30' cycle. Ensure the drum is empty and the door closed.
- ③ Touch the ►|| button. The machine will start to fill.
  - Observe the machine for any problems (eg leaking from the hose, excess noise or vibrations).
  - The washer will beep and display any faults on the screen if there are any problems. Refer to 'Before you call for Service' section at the back of this book.
- ④ Wait until you see water in the bottom of the drum.
- ⑤ Touch ►|| to stop the cycle, then press 'POWER' to turn the machine off.
- ⑥ Press 'POWER' again, select the 'Spin' cycle and touch ►||.
  - Check the drain hose is firmly secured to the standpipe or tub, or spigot.
  - Observe that the machine pumps out the water, and spins.

**If there are any problems, you must address these before proceeding with normal use. The washer dryer will automatically turn off at the end of the cycle if there are no problems.**

## BEFORE YOU DO YOUR FIRST WASH

---

**Before you start, it is a good idea to go through the following checklist:**

- ① Have the packaging and transit bolts been removed?
- ② Is the drain hose threaded through the 'U bend' (with no more than 20mm extended) and hooked into your standpipe or tub, or attached to a spigot?
- ③ Is the cold hose connected to the cold valve? Has the tap been turned on and connected to the washer dryer?
- ④ Is the machine correctly levelled? Are the feet locked and cabinet corners clear of the floor and walls?
- ⑤ Has the power cord been connected to an appropriate power supply and the power turned on?
- ⑥ Has the installation test cycle been performed?
- ⑦ We recommend you complete your first cycle with a half-load amount of detergent and without a load in order to remove any residues remaining in the machine from the manufacturing process.

# SAFETY FEATURES

## Door lock

The door of your washer dryer will lock once you touch ►|| until the machine beeps at the end of the cycle, ensuring safety for you and your family while your machine is operating.

Simply touch ►||, the machine will pause and the door will automatically unlock if the conditions inside the washer dryer are safe. The ►|| button and time to go will flash on the screen while the washer dryer is paused. Close the door and touch ►|| to resume the cycle. If items of clothing have been added or removed from your washer dryer the displayed time to go may differ from the actual cycle time. If the machine is in the middle of a wash or dry cycle and you are wanting to add or remove any items please refer to the 'Add a Garment' section below.

Note: the door will remain locked if the temperature inside the washer dryer is above 60°C and/or the water level is above the bottom of the door seal (a warning will be displayed in these circumstances, refer to 'Before you call for service').

## Add a Garment

The 'Add a Garment' function can be used to interrupt a cycle to add or remove a garment at any time during the wash or dry part of the cycle (as long as the wash temperature selected is lower than 60°C). If 'Add a Garment' is pressed during a drying cycle the machine will perform a cool down until a safe temperature is reached then the door will unlock. Refer to 'Wash and Dry Cycle Options' for more information.

## Opening the door during a power failure

If there is a power failure during a wash or dry cycle your washer dryer will stop and the door will remain locked. You can manually unlock the washer dryer door to remove your clothes by opening the pump filter cover at the bottom right of your washer dryer. Simply place a coin or key in the slot and tilt it upwards to lever the cover open, then pull the door release tab.

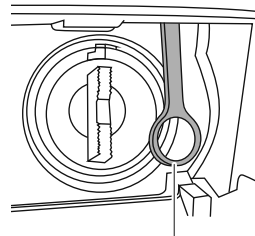

Door release tab

Manual door opening mechanism

## Do not attempt to do this if the water level in the drum is above the level of the door.

When power is restored you will need to restart your machine by simply pressing 'POWER'. The washer dryer will remember where in the cycle it was up to.

## Your washer also has the following protective measures:

- Flood protection—turns off valves and turns pump on if a flood condition is detected.
- Out-of-balance protection—stops and redistributes the load if an unbalanced load condition is sensed, and/or slows the spin speed to compensate.
- Excess suds protection—pauses to allow suds to break down before continuing the cycle.

# WASHER DRYER CONTROLS

## SmartTouch™ Control Dial

The SmartTouch™ Control Dial provides easy and efficient wash and dry cycle selection. As you rotate the dial, the icon of the wash or dry cycle selected will be illuminated, while the default settings for that cycle will be illuminated on the right side of the control panel.



SmartTouch™ Control Dial

## SmartTouch™ buttons

The smooth, easy clean buttons enable simple selection of options with lights clearly showing the selections you are making.



SmartTouch™ buttons

## Digital display screen

The digital display screen provides an estimate of how long the wash or dry cycle has to go. If you have programmed a 'Delay Start', the time remaining until the cycle will start will be displayed here, along with any messages to help you with the overall running of your washer dryer (eg user warnings).

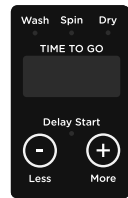

Digital display screen

## Progress lights

The progress lights indicate what part of the cycle the washer dryer is currently performing (wash, spin, dry). Two lights are on at the beginning of a wash cycle and all three lights are on at the beginning of a continuous wash and dry cycle. The light for the current part of the cycle flashes, and each one goes out when that part of the cycle is complete.



Progress lights

## Keylock mode

'Keylock' can be used to lock the buttons on your washer dryer. This will avoid accidental button pushes. For more detail refer to the 'Wash and dry cycle options' section.



'Keylock' mode

## Drum light (WD8560F1 model only)

Your machine has a drum light to help assist you when loading and unloading your washer dryer. When you press 'POWER', the LED light in the drum will turn on. After 2 minutes it will automatically turn off. At the end of the cycle, the drum light will turn on again for 5 minutes to help aid unloading.

# WASHER DRYER CONTROLS

## Time to go

Your washer dryer displays approximately how many minutes are remaining in the cycle you are running, so that you can tell at a glance when your laundry will be finished. Please be aware that a number of factors can influence the overall cycle time, eg the water flow rate, water pressure, load size, cycle, fabric type of garments, wetness of the load and options selected. Therefore, cycle times will vary, even during a cycle. Unexpected events in a wash cycle (eg out of balance, oversudsing) can lengthen the cycle time.

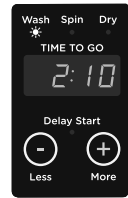

Time to go

## Wash and dry options

This button controls the functionality of your washer dryer. If you are wanting to perform an individual wash only cycle please select 'Wash'. If you are wanting a continuous wash and dry cycle please select both 'Wash' and 'Dry'. This cycle will seamlessly continue from wash to dry so your washing is completed in one easy step. If you are wanting to perform an individual drying cycle please select 'Dry'.



Wash and dry options

## Wash only

If performing a wash only cycle, the approximate wash time will be displayed and will count down until cycle completion.

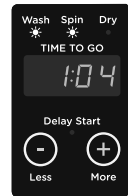

Wash only cycle

## Dry only

If performing a dry only cycle (eg 'Everyday', 'Cottons', 'Heavy', 'Delicate', 'Synthetic', 'Towels' or 'Allergy') the machine will display *AUTO* until the washer dryer has determined the time it will take to dry each specific load. *AUTO* will be replaced by the number of minutes the cycle you are running has remaining. Once your washer dryer has achieved the dryness setting you have selected, it will go into a cool down phase and display *COOL* until the load reaches a safe temperature, and then ends the cycle. In some cases when running a dry only cycle the machine will display *AUTO* and will not calculate a remaining time to go. This is normal and can occur due to a number of different factors, ie running back to back drying cycles.

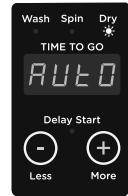

Dry only cycle

If you have chosen an 'Air Dry' cycle, your washer dryer will display a time to go until the end of the cycle is reached. If you select a 'Time Dry' cycle the machine will display the time to go until the *COOL* down period is reached and the cycle ends.

## Wash and dry

If performing a continuous wash and dry cycle your machine will display an estimated cycle time. The time depends on the cycle and options chosen, and the average time to dry a typical load size is added to the wash time. Once the wash cycle has finished the machine will display *AUTO* and recalculate the drying time depending on a number of factors. The estimated time to go will then be displayed until the cool down phase begins.

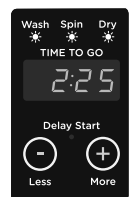

Wash and dry cycle

## WASH AND DRY CYCLES



Your washer dryer has a number of wash, dry and continuous wash and dry cycles to suit your laundering needs. Selecting the most appropriate cycle for each particular wash and dry load will help ensure you get the best wash and dry result.

CYCLE	DESIGNED FOR	DESCRIPTION
<b>Everyday</b>	Normal or lightly soiled everyday items eg t-shirts, track pants, sweatshirts, pants.	<b>Wash:</b> A faster wash cycle designed for mixed loads with normal soiling. <b>Dry:</b> High heat cycle for rapid drying of everyday clothing.
<b>Cottons**</b>	Normally soiled everyday cotton loads, eg whites.	<b>Wash:</b> A comprehensive cycle specifically designed for cottons. <b>Dry:</b> High heat cycle for rapid drying of everyday clothing.
<b>Heavy</b>	Heavy soiled durable garments eg rugby shorts.	<b>Wash:</b> A stronger, hotter wash for difficult stains on durable fabrics. <b>Dry:</b> Longer, high heat cycle for heavy fabrics and denims.
<b>Synthetic</b>	Normally soiled, everyday synthetic or mixed clothing items eg business shirts, t-shirts.	<b>Wash:</b> A cycle tailored to washing synthetic and mixed fabric types. <b>Dry:</b> Low heat cycle for drying synthetic garments.
<b>Delicate</b>	Delicate, lightly soiled items eg tops, blouses.	<b>Wash:</b> Gentler wash with more water to look after delicate items. <b>Dry:</b> Low heat cycle for carefully drying delicate and heat sensitive fabrics.
<b>Towels</b>	Normally soiled towel loads.	<b>Wash:</b> A cycle specifically designed for towels. <b>Dry:</b> High heat cycle to dry and fluff towel loads.
<b>Allergy</b>	Asthma sufferers and people with skin sensitivities.	<b>Wash:</b> Hot wash to kill dust mites and extra rinses to remove all traces of detergent. <b>Dry:</b> Longer, high heat cycle for rapid drying.
<b>Quick Wash 30</b>	Lightly soiled garments.	<b>Wash:</b> A quick cycle for lightly soiled loads. <b>Dry:</b> High heat cycle for rapid drying.
<b>Rinse</b>	Items that require rinsing only.	<b>Wash:</b> Two rinses followed by a spin. <b>Dry:</b> High heat cycle for rapid drying.
<b>Spin</b>	Spinning wet items.	<b>Wash:</b> Spin only. <b>Dry:</b> High heat cycle for rapid drying.
<b>Air Dry</b>	Drying items for a specific time period, without heat.	<b>Wash:</b> N/A. <b>Dry:</b> 40 minute cycle with no heat.
<b>Time Dry</b>	Drying items for a selected period of time.	<b>Wash:</b> N/A. <b>Dry:</b> A cycle with specific drying times ranging from 30-150 minutes.
<b>Drum Clean</b>	Maintaining the cleanliness of your washer dryer.	<b>Wash:</b> A hot cycle to remove any residues inside the washer dryer. <b>Dry:</b> N/A.

## WASH AND DRY CYCLES

CYCLE	MODELS MAX. LOAD SIZE (WASH/DRY) (KG)*	DEFAULT WASH TEMP. (°C)	MAX. WASH TEMP. (°C)	DEFAULT SPIN SPEED (RPM)	MAX. SPIN SPEED (RPM)	DEFAULT DRYNESS LEVEL***
Everyday	WD8560F1: 8.5/5 WD8060P1: 7/4 WD7560P1: 7.5/4	40	90	1400	1400	Dry
Cottons**	WD8560F1: 8.5/5 WD8060P1: 7/4 WD7560P1: 7.5/4	40	90	1400	1400	Dry
Heavy	WD8560F1: 8.5/5 WD8060P1: 7/4 WD7560P1: 7.5/4	60	90	1400	1400	Dry
Synthetic	WD8560F1: 4/3 WD8060P1: 4/2 WD7560P1: 3/2	40	60	1100	1100	Dry
Delicate	WD8560F1: 4/3 WD8060P1: 4/2 WD7560P1: 3/2	30	40	500	800	Dry
Towels	WD8560F1: 6/5 WD8060P1: 5/4 WD7560P1: 5/4	40	90	1400	1400	Extra Dry
Allergy	WD8560F1: 8.5/5 WD8060P1: 7/4 WD7560P1: 7.5/4	60	90	1400	1400	Extra Dry
Quick Wash 30	WD8560F1: 4/3 WD8060P1: 4/2 WD7560P1: 3/2	40	60	800	1400	Dry
Rinse	WD8560F1: 8.5/5 WD8060P1: 7/4 WD7560P1: 7.5/4	Cold	Cold	1400	1400	Dry
Spin	WD8560F1: 8.5/5 WD8060P1: 7/4 WD7560P1: 7.5/4	N/A	N/A	1400	1400	Dry
Air Dry	WD8560F1: N/A/5 WD8060P1: N/A/4 WD7560P1: N/A/4	N/A	N/A	N/A	N/A	N/A
Time Dry	WD8560F1: N/A/5 WD8060P1: N/A/4 WD7560P1: N/A/4	N/A	N/A	N/A	N/A	N/A
Drum Clean	N/A	90	90	1400	1400	N/A

\* Depends on your model of washer dryer (8.5kg/5kg, 7kg/4kg or 7.5kg/4kg)

\*\* **WD8560F1 and WD7560P1 models only.** 'Cottons', 'Wash, '40°C, '1400' rpm, 'Eco' selected is the recommended water and energy saving cycle for normally soiled, everyday washing. 'Cottons', 'Dry', 'Dry' (Dryness level), 'Eco', '1400' rpm selected is the recommended energy saving cycle for drying of everyday cotton items.

\*\* **WD8060P1 model only.** 'Cottons', 'Wash, '40°C and '60°C, '1400' rpm, 'Eco' are the standards energy testing and labelling cycles in accordance with EN 50229:2007 and EU directive 96/60/EC. These are the standard cotton programmes for normally soiled cotton laundry. They are the most efficient programmes in terms of combined energy and water consumption for cotton laundry. The wash temperature may differ from declared cycle temperature. 'Cottons', 'Dry', 'Dry' (Dryness Level), 'Eco', '1400' rpm selected is the recommended energy saving cycle for everyday cotton items.

\*\*\* 'Dryness Level' is only an option on automatic sensing cycles. On the 'Air Dry' and 'Time Dry' cycles, dryness will vary depending on the load and its initial moisture content.



# DETERGENT AND FABRIC SOFTENER

## Detergent type

Your washer dryer requires low sudsing detergent to prevent oversudsing problems. Low sudsing detergent comes in **powder**, **liquid** or **pod** form and is labelled '**Top Loader/Front Loader**', '**Low Suds**', '**High Efficiency**' or '**HE**'.

Using any other detergent type that is not recommended for front loaders, may lead to excessive suds formation, which will lengthen the cycle time as the machine waits for the suds to dissolve.

## Where do I put my detergent?

### Liquid detergent

If you wish to use liquid detergent, add it to the main wash compartment on the left side of the dispenser drawer marked with a **II** (**A**). As the machine fills, water is flushed into this compartment and is mixed with the detergent, the detergent solution is then delivered to the drum. There may be a small volume of water left in the liquid detergent dispenser at the end of the cycle. This is normal.

### Powdered detergent

If you wish to use powdered detergent, the liquid detergent compartment **MUST** be removed from the dispenser drawer. To do this firmly grasp and twist and pull the left hand side of the internal compartment and pull upwards (**B**). To replace the liquid detergent compartment slide it back into the drawer marked **II** (**C**). Press down in the middle until it clicks (**D**).

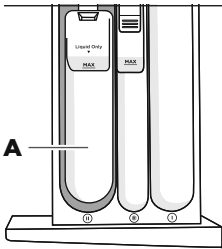

Detergent dispenser drawer

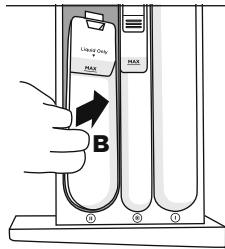

Removing the liquid detergent compartment

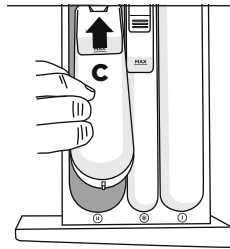

Replacing the liquid detergent compartment

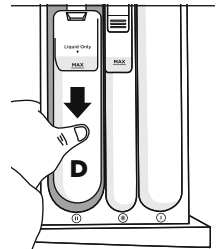

Clicking in the liquid detergent compartment

- If using liquid detergent ensure the liquid detergent compartment is installed.
- If using powder ensure the liquid detergent compartment has been removed.
- Make sure the detergent drawer is completely closed before starting the cycle.
- If performing an individual drying cycle make sure there is no detergent in the dispenser drawer.

# DETERGENT AND FABRIC SOFTENER

## Pods

Detergent pods are a 'no mess' alternative to powdered or liquid detergent. They must be placed at the back of the drum prior to loading your clothes. This will ensure they are activated quickly in the wash. Do not place pods in the detergent dispenser drawer or on top of your clothes.

## Pre Wash

If you wish to use the 'Pre Wash' option, liquid or powdered detergent must only be placed in the pre wash detergent compartment on the right hand side of the drawer, marked with ①. When you select 'Pre Wash', the pre wash compartment is flushed at the start of the cycle. For more information refer to 'Wash cycle options'.

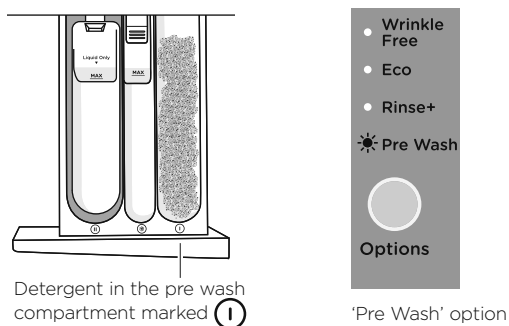

**Make sure the detergent dispenser drawer is completely closed before starting the cycle.**

## How much detergent?

The correct detergent dosage varies depending on the amount of soil in your load, the size of the load and the water quality, so getting the correct dose takes some trial and error. Use the instructions stated on the detergent package as a guide, then alter the dosage according to the results.

If you overdose, you will get over foaming issues, but if you under-dose you will get poor performance and over time your washer dryer will start to smell as dirt and bacteria builds up inside it.

### Detergent advice

- ① If your washer dryer smells you are probably not using enough detergent for the soil level in your loads. Run a 'Drum Clean' cycle and either try a better quality detergent or use a higher dose. If you are using an 'Eco' detergent, alternate the use of this with a mainstream detergent.
- ② Add the detergent BEFORE starting the cycle, close the dispenser and do not open it while the cycle is running.
- ③ If you find foam leaking from your washer dryer, check you are using a low sudsing or front loader type detergent and check the quantity you are using against the detergent manufacturers recommendation. You may need to reduce the quantity you are using.

### Fabric softener

Add fabric softener to the middle compartment of the dispenser marked with a . The washer dryer will automatically flush the fabric softener during the rinse part of the cycle.

#### If you wish to use fabric softener we recommend to:

- ① Use it sparingly. Measure it carefully and do not use more than 25mls (1/2 cap), some thicker varieties may need diluting.
- ② Clean your dispenser regularly.
- ③ Clean your machine regularly using the 'Drum Clean' cycle.
- ④ Complete wash cycles at a wash temperature of 40°C or above at regular intervals (eg every 5th wash) as washing in cold water increases the chance of scrud occurring (see below).

Note: if you fill beyond the MAX mark, the fabric softener will be dispensed into the bowl prematurely and contribute to scrud.

### Scrud

Scrud is the name of the waxy build-up that can occur within any washing machine (including washer dryers) when fabric softener comes in contact with detergent. This build-up is not brought about by a fault in the machine. If scrud is allowed to build up in the machine it can result in stains on clothes and an unpleasant smell in your washer dryer.

If you wash a particularly dirty load, we recommend putting your washer dryer through a 'Rinse' cycle once the cycle has finished and the load has been removed, to clean out any remnants from that cycle.

## WASH PREPARATION

---

When preparing your washer or dryer load there are some important things to consider:

### Sorting

- It is best that you sort your garments before placing them into the washer dryer. Sort into loads of similar items, and loads that will take similar times to dry. Always separate coloured items from whites, especially when they are new.
- Some soils, like mud and blood are best washed in cold water. Oily soils (eg some food stains or makeup) are best washed in warm water.
- Look for care label instructions on your clothes as this will inform you of wash and dry recommendations.
- Wash and dry fine, delicate fabrics (eg synthetics and polyester-cotton shirts) separately from thick, heavy fabrics (eg towels, flannelette sheets). This prevents damage and the possibility of some items becoming over-dried whilst others are still damp. It also helps to extend the life of your clothing and linen.
- We recommend removing your clothes from the washer dryer after the completion of a wash or dry cycle to help decrease the chance of wrinkles, and dye transfer from coloured items to white items.
- Wash and dry towels on the towels cycle to reduce lint transfer onto other clothing items and to efficiently wash and dry towels.
- Items of clothing with screen-printing should be turned inside out to prevent damage to the print. Also garments with hooks or zippers should be fastened and where possible, turned inside out.
- In the following table (next page) there are recommendations for what cycles and settings you may wish to wash and dry different items on, and suggestions for special wash and dry requirements.

**Over loading the washer dryer with a dry load above this line on any drying cycle can lead to poor drying performance.**



## WASH PREPARATION

SPECIFIC ITEM REQUIREMENTS	SUGGESTED WASH/DRY CYCLE AND OPTIONS	COMMENTS
Towels	<b>Wash:</b> Towels, 1400 or 1100 rpm spin, 40°C, Wrinkle Free. <b>Dry:</b> Towels, Extra Dry, Wrinkle Free.	Towels produce a lot of lint and are best dried on their own.
Sheets, pillowcases, duvet/ doona covers	<b>Wash:</b> Everyday, 1400 or 1100 rpm spin, 30°C or 40°C. <b>Dry:</b> Everyday, Dry.	Ensure duvet/doona cover openings are buttoned/domed before placing in the washer dryer.
Bulky items — doonas, duvets, sleeping bags	<b>Wash:</b> Synthetic, 40°C or 60°C, Rinse+, 800 rpm. <b>Dry:</b> Synthetic, Dry.	Only wash and dry one bulky item at a time and place a few knotted towels into the machine at the same time when drying to help move the item around.
Shirts, pants, other creasables	<b>Wash:</b> Synthetic, 800 rpm, 30°C or 40°C, Wrinkle Free. <b>Dry:</b> Synthetic, Dry, Wrinkle Free.	'Wrinkle Free' should be selected to help minimise creasing once the wash and/or drying cycle has finished.
Woolens, silks	<b>Wash:</b> Delicate, 500 rpm, 30°C or 40°C. <b>Dry:</b> N/A.	A gentle deep water wash for delicate items, where it is best to dry these clothes on a flat surface away from direct sunlight.
Delicates, fine fabrics	<b>Wash:</b> Delicate, 500 rpm, 30°C. <b>Dry:</b> Delicate, Dry.	You can further reduce the dryness level to damp for very delicate items.
Jeans	<b>Wash:</b> Everyday or Heavy, Cold or 30°C. <b>Dry:</b> Everyday or Heavy, Dry or Extra Dry.	Turn jeans inside out to help maintain their appearance. Dry separately from other items.
Highly coloured items	<b>Wash:</b> Everyday, Cold or 30°C. <b>Dry:</b> Everyday, Dry.	Wash new brightly coloured clothing individually to ensure colour run does not occur.
Whites, cotton items	<b>Wash:</b> Cottons, 1400 or 1100 rpm, 40°C or 60°C. <b>Dry:</b> Cottons, Dry.	Cotton can withstand high temperatures, use 'Wrinkle Free' to minimise creasing.
Have sensitive skin or require extra rinsing	<b>Wash:</b> Allergy, Rinse+, 1400 rpm or 1100 rpm, 40°C or 60°C. <b>Dry:</b> Allergy, Extra Dry.	Greater water-using cycle to ensure all detergent is rinsed out of the load.
Asthma/allergies	<b>Wash:</b> Allergy, Rinse+, 1400 rpm or 1100 rpm, 40°C or 60°C. <b>Dry:</b> Allergy, Extra Dry.	Wash on high temperatures to kill bugs and germs and increase dryness level to ensure no moisture is left in the items.
Lightly soiled items	<b>Wash:</b> Quick Wash 30, 30°C. <b>Dry:</b> Everyday, Dry or Quick Wash 30 (if doing continuous wash and dry cycle).	For small load sizes that are lightly soiled or that need a quick freshen up.
Muddy, sandy or linty items	<b>Wash:</b> Everyday, Pre Wash, Rinse+, Cold. <b>Dry:</b> Everyday, Dry.	Emptying the pump filter after washing these items and performing a rinse cycle with an empty drum to wash away any residue is recommended. The pump filter after washing these clothes and performing a rinse cycle with an empty drum to wash away any residue.
Smelly washer dryer	<b>Wash:</b> Drum Clean, 90°C. <b>Dry:</b> N/A.	Include detergent to wash away any scrud or dirt build up.

# WASH PREPARATION

---

## Before you load

- Check pockets for items that could damage your clothes or get caught in the washer dryer.
- Close zippers, hooks and eyes, and other fastenings (ie fasten the opening of duvet/doona covers), and remove loose bra wires. All these can damage both your washer dryer and your clothes.
- Place delicate items, such as lingerie, in a mesh laundry bag if performing a wash only cycle. If performing a continuous wash and dry cycle or an individual dry cycle it is recommended not to use a mesh bag to ensure good drying performance.
- Pre-treat any stains, taking care not to spray pre-treaters on your washer dryer as they can cause damage to the plastic surfaces.

## Loading

- It is more efficient to wash larger loads, so try to collect enough items to loosely fill the drum when the items are dry.
- If performing a continuous wash and dry cycle or an individual dry cycle please take note of the dryer capacity to ensure the appropriate dryness level is reached. Note: the dryer capacity is less than the wash capacity.
- Before performing a continuous wash and dry cycle or an individual dry cycle, garments should be fluffed up and loaded evenly to minimise creasing and wrinkling, and to ensure the load is dried evenly. Make sure there is plenty of room for the garments to tumble freely while drying.
- It is a good idea to wash and dry 'permanent press' types garments (eg business shirts) together on a separate cycle with the 'Wrinkle Free' option on. This will help reduce wrinkling and the need for ironing.
- If you run a wash cycle then manually want to select a drying cycle, fluff up the items in the machine before starting a drying cycle.
- Hint: For a drying cycle, load the washer dryer in terms of the space the garments take up when dry, rather than wet. Do not overload a drying cycle as it may damage your washer dryer and clothes.

## To reduce tangling

- Load items individually when performing a drying cycle.
- Only dry bedding loads of up to a maximum of 5kg or 4kg in the dryer (depending on the model).

## To reduce creasing

- If performing a continuous wash and dry cycle remove items from the dryer as soon as the drying cycle is completed.
- If the items are going to be left in the machine after any cycle, select 'Wrinkle Free' to help reduce creasing.
- Shake clothes out after a wash cycle and before performing a dry cycle and load individually to help items dry evenly.
- Launder permanent press garments separately, eg business shirts.
- Allow enough room in the dryer for clothes to tumble freely.
- Hang garments as soon as the dry cycle is complete to reduce the need for ironing.

# WASH PREPARATION

---

## Lint

- Some items are lint givers, while others are lint collectors. Always dry lint givers and collectors separately.
- Delicate or easily damaged items (eg silk garments, nylon stockings, fine fabrics, delicate embroidered fabrics, garments with metal accessories, sleeping bags or other down items) should be dried separately, using the 'Delicate' cycle

<b>LINT GIVERS</b>	<b>LINT COLLECTORS</b>
Towels	Synthetics eg polar fleece
Flannelette sheets	Corduroy
Nappies	Polyester cottons

- Do not overload your washer dryer beyond its rated capacity.
- Never put dripping wet clothes on top of the washer dryer as excess water may cause an electrical hazard.
- Do not wash or dry an electric blanket or any other electrical, plastic or rubber items in your washer dryer unless the care label specifically states it is safe to do so. Never dry these items at high temperatures.
- Do not wash or dry curtains in this washer dryer, as sunlight makes them brittle and they may disintegrate during washing or drying.

Note: this washer dryer is designed to be used as a washer then a dryer, please keep dry only cycles to a minimum to ensure lint is flushed out of the machine between drying cycles.

## GETTING STARTED QUICKLY

- Sort your washing carefully. Separate white/light colours from dark colours. Wash new, highly coloured and dark coloured items separately to prevent dye transfer. Refer to the 'Sorting and loading' section.
- Load your clothes individually into the drum. Close the door.
- Use '**Top Loader/Front Loader**', '**Low Suds**', '**High Efficiency**' or '**HE**' powder, liquid or pods. Pour liquid detergent into the correct compartment in the dispenser drawer marked ①. If you wish to use powdered detergent you **MUST** remove the liquid detergent insert by firmly grasping and twisting the left hand side of the internal compartment and pulling upwards. If you are using detergent pods place them at the back of the drum before adding your clothing. For more information on detergent refer to the 'Detergent and fabric softener' section.
- If you wish to use fabric softener, pour it in the compartment marked with a ②. For more information on fabric softener refer to the 'Detergent and fabric softener' section.

**Fabric softener should not be used if you have selected the 'Quick Wash 30' cycle.**

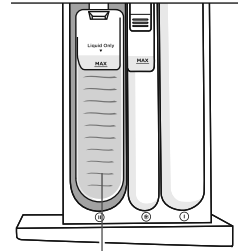

Liquid detergent in compartment marked ①

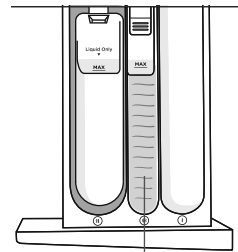

Fabric softener in compartment marked ②



## GETTING STARTED QUICKLY

- ① Press 'POWER' to activate your washer dryer.
- ② Select your wash or dry cycle by turning the SmartTouch™ Control Dial.
- ③ If you are wanting to perform a wash, dry or continuous wash and dry cycle touch the 'Select' button to change to the desired cycle functionality.
- ④ Choose your wash or dry options (if you wish to select options different from the default options for the cycle).
- ⑤ Touch ►|| to start the cycle.

- If you make an invalid selection the washer dryer will beep to alert you.
- When the cycle finishes, your washer dryer will perform end of cycle beeps and then turn off automatically.
- If you wish to stop your washer dryer at any point during a wash or dry cycle simply touch ►|| to pause the cycle. There may be a slight delay while the drum comes to a stop, then the door will unlock. Under certain conditions however the door will remain locked for safety reasons (refer to the 'Safety features' section).
- If you wish to cancel or change the wash cycle once a cycle has started, simply touch the ►|| button then select the new cycle. Touch ►|| to restart the washer dryer.

- **For the best fabric and colour care, remove your clothes as soon as the cycle has finished.**
- **Failure to follow the advice in this guide may result in damage to your garments and your expectations of wash and dry performance may not be met.**
- **Sort and load items into the drum, ensuring no items are in the way of the door. Close the door (you will hear it click).**

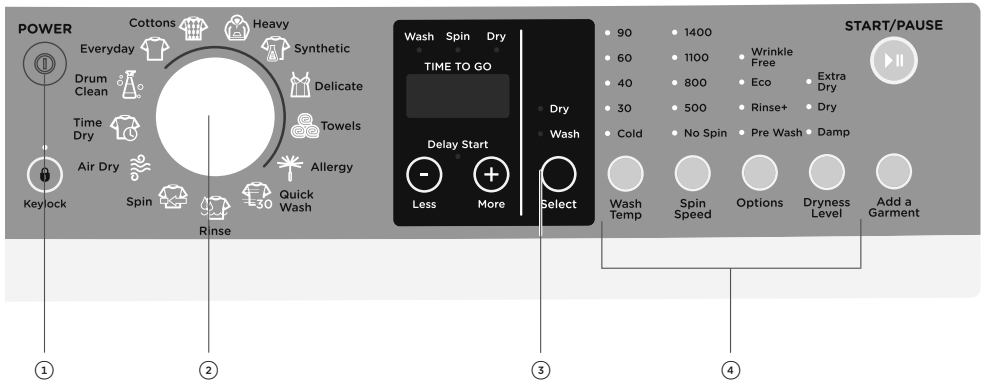

## WASH AND DRY CYCLE OPTIONS

---

All wash and dry cycles default to the recommended options for that cycle based on the average load expected to be washed. You can vary the options (eg 'Wash Temp', 'Spin Speed') to create your desired cycle. Note: some options are not available on some cycles, for clothes care reasons, or because the option is not appropriate for the cycle.

To change a wash or dry option or options you have selected after a cycle has started, simply touch ►|| and select your new setting, then touch ►|| again to resume the cycle with the new setting or settings. Note: some options may not be available for selection under certain conditions and after particular stages of the cycle have passed.

### Wash Temp

Your washer dryer offers five wash temperatures:

Cold	30°C	40°C	60°C	90°C
------	------	------	------	------

- Simply touch the 'Wash Temp' button to increase or decrease the wash temperature.
- The washer dryer will fill with cold water and heat the water to the selected temperature (if required).
- Some temperatures are not available on some cycles as a safeguard for your clothes (eg 90°C on the 'Delicate' cycle).

### Spin Speed

- Simply increase or decrease the spin speed by touching the 'Spin Speed' button. Selecting different spin speeds will limit the wash, rinse and final spin speed.
- Selecting 'No Spin' will end the cycle after the rinse, allowing you to remove items you wish to drip dry. If you have removed the items you wish to drip dry and there are items remaining that you would like to process to spin, press 'POWER' and select the Spin cycle. If necessary, modify the spin speed to best care for your load (ie spin delicate items at '500' rpm for best garment care).
- Some continuous wash and dry cycles will limit spin speed selections to optimise drying performance.

## WASH AND DRY CYCLE OPTIONS

---

### Options

#### Pre Wash

For extra dirty loads you can perform a 'Pre Wash'. Your washer dryer will start the wash with a short wash in cool water to remove excess soil. After this the machine will drain and then fill with the selected temperature for the main wash.

Simply touch the 'Options' button and select 'Pre Wash' when choosing your wash options. Note: 'Pre Wash' cannot be selected after a wash cycle has been started, ie if you touch ►|| and try to select 'Pre Wash' it will be unavailable. 'Pre Wash' must be selected at the start of the cycle.

If you use the 'Pre Wash' option, liquid or powdered detergent needs to be placed in the correct detergent compartment. The pre wash compartment is on the right hand side of the drawer, marked ❶. When you select 'Pre Wash', the compartment is flushed at the start of the cycle.

#### Rinse+

If you have a particularly dirty load, or you have sensitive skin and wish to give your clothes an extra rinse, select 'Rinse+' from the 'Options' button. Your load will undergo an extra rinse to get rid of any residual detergent or soil in the items. Note: 'Rinse+' will not be available if the 'Eco' option has been selected.

#### Eco

Use the 'Eco' option to save water and energy. Selecting 'Eco' will reduce the wash temperature slightly and alter the wash and rinse programming. 'Eco' on a drying cycle will perform a specially designed spin to optimise drying efficiency. 'Eco' selected for a continuous wash and dry cycle will perform both of these 'Eco' functions making it a water and energy efficient cycle.

Note: this option will not be available if the 'Pre Wash', 'Rinse+' or 'Wrinkle Free' options have been selected.

#### Wrinkle Free

We recommend you remove the clothes from the washer dryer immediately after the completion of the wash or dry cycle to minimise wrinkling and creasing of items and to prevent dye run. However, if you will not be present at the end of the wash and/or dry cycle you can select 'Wrinkle Free'.

When 'Wrinkle Free' is selected, the washer dryer will tumble the clothes once every 15 minutes for up to 12 hours after the wash or dry cycle has finished. The 'Wrinkle Free' light and ►|| button will flash, and the washer dryer will beep at regular intervals to remind you to remove your load. To remove the load during this phase, simply touch the ►|| button.

## WASH AND DRY CYCLE OPTIONS

---

### Dryness Level

Your washer dryer takes the guess work out of choosing drying times by sensing the dryness of the load. When your washer dryer senses that the clothes have dried to the dryness level you have selected, the washer dryer will automatically enter the cool down phase then finish the cycle.

The washer dryer has three dryness levels to choose from; 'Damp', 'Dry' and 'Extra Dry'. Choose the dryness level to suit your load depending on how dry you wish your clothes to be. If you find the load is not dry enough, select the next dryness level up. The higher the level, the longer the drying time and the drier your clothes will become.

Once the washer dryer has sensed that the load is dry it will automatically go into an airing or cool down phase. During cool down the drum tumbles and cool air is blown through the clothes. The machine will end the cycle when the load and the machine have reached a safe temperature.

- If you wish to, you can select a combination of these options to operate on the same cycle. Simply touch the appropriate button until both options are selected. Repeat to deselect an option.
- For clothes care and performance reasons not all options may be available on some cycles.

### Add a Garment

The 'Add a Garment' option enables you to add or remove items during the wash or drying stages of a cycle, under certain conditions. Once the 'Add a Garment' button is touched during a wash cycle, the ►|| button and time to go will flash. Wait until you hear the door unlock. Open the door and add or remove items. Close the door and touch ►|| to restart the cycle. The 'Add a Garment' button will only operate when the wash temperature selected is lower than 60°C. 'Add a Garment' can be used when the total wash volume has been reached, as your washer dryer will drain the water to a lower level if necessary, so the door can be opened.

If selecting 'Add a Garment' in a drying cycle the machine will automatically go into a cool down phase and will display [ 0 0 L to decrease the temperature inside the drum to a safe level. This may take a while depending on the cycle selected, load type, load size and drying cycle completion time. The door will unlock when it has reached a safe temperature for you to add or remove items. Close the door and touch ►|| to restart the cycle. The machine will display R U L until the end of the cycle is reached then [ 0 0 L will be displayed.

## WASH AND DRY CYCLE OPTIONS

---

### Keylock



This option enables you to deactivate the buttons on the display panel, except for the 'POWER' and 'Keylock'  buttons. This prevents accidental button presses.

**To turn 'Keylock' mode ON or OFF when the washer dryer is powered on:**

- Touch and hold the  button for 2 seconds.





Note: when activated, the light above the  button is illuminated.

**If 'Keylock' mode is activated and the machine is powered off:**



- To turn your washer dryer on, press the 'POWER' button, then touch and hold the  button for two seconds. Select your wash cycle, options and then touch  to start the cycle.
- To turn the washer dryer off at anytime when 'Keylock' is activated simply press the 'POWER' button.

### Delay Start



The 'Delay Start' option enables you to delay the start of the wash cycle from between 5 minutes and 12 hours. Times you can select are 5 min, 15 min, 30 min, 1 hour, then hourly up to 12 hours. This can be useful to time your washing or drying to finish when you arrive home from work, or to start once you have finished in the shower. Some stain removers also require you to spray them on then leave for several minutes before washing. Your washer dryer will wait for the selected time then start without you having to wait or remember to start your machine.

To programme a 'Delay Start' time, simply touch the 'More'  button to increase the delay time and 'Less'  button to decrease the time or turn 'Delay Start' off. Touch  to confirm your selection and start the countdown. Once started, the time will count down on the digital display screen in 1 minute increments, the 'Delay Start' light will flash and the  light will stop flashing and turn on solid.

Note: if you hold the 'More'  button down, the time displayed on the screen will increase after every half a second (more convenient than touching the button repetitively).

To remove a 'Delay Start' time once it is counting down, simply touch  , then touch the 'Less'  button to decrease the time to zero. Touch  to start the cycle immediately.

We suggest that you avoid using 'Delay Start' for damp, non-colourfast items as this may cause dye run to occur.

Note: for the 'Time Dry' cycle the 'Delay Start'  and  buttons are used to increase and decrease the time for a 'Time Dry' cycle. The delay start functionality cannot be used on a 'Time Dry' cycle.

## CUSTOMISING WASH AND DRY CYCLES

---

After using your washer dryer a few times you may discover there are some wash or dry options you prefer for some cycles.

You can programme your washer dryer to remember the wash and dry options you prefer for each cycle. For instance, you may want to set the 'Everyday' cycle to 'Cold' wash temperature or set the 'Heavy' cycle so it gives you 'Rinse+' every cycle.

### To customise a cycle:

- ① Press 'POWER' to turn the machine on.
- ② Turn the dial to select the cycle you wish to customise.
- ③ Touch and hold any of the wash option buttons for 3 seconds. The cycle icon will flash on and off to indicate that the product is in cycle adjustment mode. The display will show *SEt*.
- ④ Select the wash and dry options you prefer by touching the relevant option button.
- ⑤ Touch **⏸** to save the selected settings.

Your washer dryer will automatically remember your changes for all future wash or dry cycles you do.

### Factory reset

You can reset your washer dryer to the default settings it left the factory with:

- ① Turn the dial to select 'Spin'.
- ② Touch and hold these three buttons together for 3 seconds; 'Options' 'More' **+**, and 'Less' **-** until *dEF* appears on the screen and the machine has beeped.
- ③ Your washer dryer will now be reset to the default settings.

# CARING FOR YOUR WASHER DRYER

## When you have finished using your washer dryer

- Unplug the machine from the power socket.
- Wipe around the door and in the rubber gasket to remove any remaining water/condensation, lint and foreign matter.
- Turn off the taps to prevent the chance of flooding should a hose burst.

## Cleaning your washer dryer

Before you start cleaning your washer dryer, ensure that it is disconnected from the power (ie unplug the machine from the power socket).

### Cleaning the control panel and outer surfaces of the washer dryer

Use a soft damp cloth to wipe all surfaces, then wipe dry. Avoid using chemical or scouring cleaners, as these will damage the paint and plastic surfaces of your washer dryer.

### Cleaning the detergent dispenser drawer

Wipe out the detergent dispenser drawer with a damp cloth. Clean it regularly, especially if you use fabric softener. To remove the drawer, pull it open, push down on the tab in the fabric softener compartment and pull out. Rinse it out under warm water and replace.

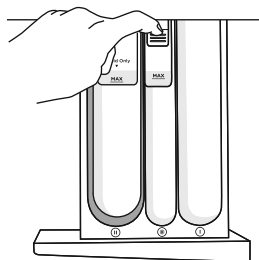

Removing the dispenser drawer for cleaning



### Cleaning the inside of your washer dryer

It is important that you regularly clean the inside of your machine using the 'Drum Clean' cycle. After 100 cycles the  icon will flash every time you turn your washer dryer on to remind you to do this. If your washer dryer starts to smell this is a sign that you should complete a 'Drum Clean' cycle. We recommend that you do not have any items in the washer dryer when you run this cycle.



'Drum Clean' cycle

### Cleaning steps

- ① Add approximately 2 full scoops of a good quality powdered detergent directly into the main wash detergent compartment of the dispenser drawer (marked ) or use a drum cleaning product specifically designed for front loading washing machines (follow manufacturer's instructions).
- ② Press 'POWER' to turn your machine on and select the 'Drum Clean' cycle.
- ③ Touch  to start the cycle (refer to the 'Wash and dry cycles' section).

# CARING FOR YOUR WASHER DRYER

## Cleaning the drum and the door

- Use a soft damp cloth to wipe the door, cleaning any water marks or residue off it.
- Wipe the rubber seal around the door. Remove any items or lint accumulating in the bottom of the seal catchment and wipe out any water accumulated here. If this is not cleaned out, unpleasant odours will develop.
- If the drum has any residual dirt or lint stuck to it, remove this and wipe the drum clean. Do not leave any metal objects in the drum as these may rust and cause staining.
- WD8560F1 has a self cleaning door flush that directs a portion of the rinse water over the door during various stages of the cycle to help to clean hair and insolubles from the inside of the door and surrounding parts. We still recommend that you manually clean it with a soft cloth periodically as per the instructions above.

## Cleaning the pump filter

The pump has a filter to trap foreign objects that enter the washer dryer along with clothing. The pump filter can be accessed from the front of the washer dryer.

### To clean the filter:

This should be cleaned out approximately once a month.

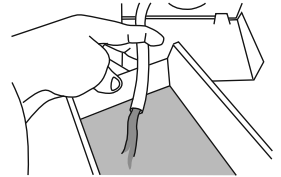

Drain residual water

- ① Turn the power off and unplug the machine.
- ② Use a coin to open the filter cover. Place the edge of the coin into the slot and tilt upwards whilst levering the cover open.
- ③ Unhook the pump outlet hose and pull it out (about 150mm). Remove the plug and allow any water (approximately 250ml) to drain into a shallow dish.
- ④ After the draining process is complete, replace the plug into the hose and refit the hose back into the housing.
- ⑤ Remove the filter by turning anti-clockwise. Clean and rinse under a tap.
- ⑥ Replace the filter by turning clockwise until the white mark on the filter is in line with the white line on the pump housing.
- ⑦ Make sure the propeller is freely moving at the back of the filter cavity, remove any foreign objects.
- ⑧ Close the filter cover.

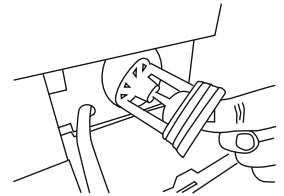

Replacing filter

White marks are in line

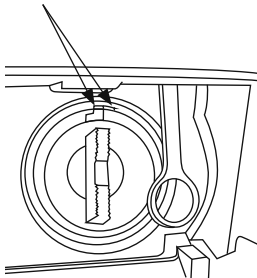

Correct

White marks are not in line

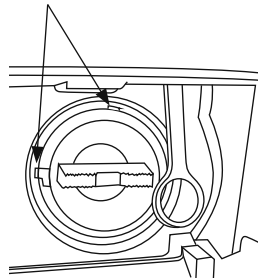

Incorrect

White mark on filter must be in line with white line on pump housing



## CARING FOR YOUR WASHER DRYER

---

### Cleaning the hose

The hose has a filter in it, preventing any solid contaminants in the water entering your washer dryer. Occasionally you should disconnect the water inlet hose where it connects to the taps, check for any build up of dirt and wash this out.

### Nappy sanitisers/bleach

Nappy sanitisers and bleach are very corrosive to metal surfaces. DO NOT tip the contents of a nappy bucket into your machine. Rinse and wring items out thoroughly before placing them in the machine.

### Moving your washer dryer

If you need to move your washer dryer a considerable distance (eg moving house), **remember to replace the transit bolts before moving it.** These will protect internal components of the washer dryer from damage.

To replace the transit bolts, pull out the bolt-hole covers at the back of the machine. Push the transit bolt rubber grommets and plastic spacers into the hole left and tighten it with the spanner provided with the product.

Make sure any water in the washer dryer is drained out. This can be done by cleaning out the pump filter (refer to 'Caring for your washer dryer' section 'Cleaning the pump filter').

- Leave the door to your washer dryer open when it is not in use to allow the washer dryer to dry out, otherwise it will develop unpleasant odours. When leaving the door open like this, it is extremely important that children and pets are kept away from the washer dryer so they cannot be accidentally trapped inside it.
- Aside from the detergent dispenser, water hose, and the pump filter, no other parts are designed to be removed from the machine for cleaning. Do not attempt to remove any other part of the machine.

## BEFORE YOU CALL FOR SERVICE

### User warnings

Your washer dryer is capable of diagnosing a number of its own problems. It will sound a continuous series of beeps and display a code when it has a problem that you can correct yourself. All control panel lights will turn off and the code will be displayed to inform you what the problem is. To stop the beeps, press any button on the control panel. Do not try to continue washing or drying once you stop the noise. You must address the problem the washer dryer is alerting you to.

Check this chart before you call for service.

PROBLEM	DISPLAYED AS	WHAT TO DO
<b>Water is not getting to the machine</b>	<i>n o</i> <i>t R P</i>	Check the tap has been turned on.
		Check the hose connection.
		Check the inlet hose filter is not blocked, the hose is not kinked and is attached correctly.
		Check that the drain hose is not too low or pushed into the standpipe too far. This will cause the water to siphon out of the machine.
		Check the cold water temperature does not exceed the 35°C temperature requirement.
		Check the water flow rate. It maybe too low.
<b>Wash load is out of balance</b>	<i>o u t</i> <i>o f</i> <i>b a l</i>	Touch ►   to try the spin again.
		If the out of balance persists, pause the cycle, manually redistribute the load and touch ►   to spin again. If necessary, stop the cycle, select 'Spin' and touch ►  .
		If the problem persists, check the machine is correctly levelled.
<b>Too many suds</b>	<i>S u d</i> <i>L O C</i>	Machine will stop and flash <i>S u d L O C</i> while waiting for suds to dissipate. The machine will not beep during this time. When the suds have dissipated, the machine will automatically restart.
		If a suds event has occurred during a cycle the machine will also display this warning at the end of the cycle, to alert you that this has occurred. This may help to explain any reduction in performance.
		Check you are using a suitable detergent.
		Check you are not overdosing the detergent.
		Check the standpipe height for the drain does not exceed 1200mm.

## BEFORE YOU CALL FOR SERVICE

PROBLEM	DISPLAYED AS	WHAT TO DO
Machine is too hot	<i>t o o H o t</i>	The temperature in the drum is over 60°C therefore it is not safe to open the door. Wait until the temperature drops below 60°C then the machine will open the door.
Door is locked	<i>d o o r L o c k</i>	<p>The temperature in the drum is over 60°C therefore it is not safe to open the door. Wait until the temperature drops below 60°C.</p> <p>Check the water level in the drum. If the level is above the bottom of the door seal, the door cannot be opened. Use the 'Add a Garment' button if you wish to add or remove items.</p> <p>If the drum is still moving, wait for it to stop before attempting to open the door.</p>
Door is open	<i>d o o r O P E n</i>	<p>Close the door fully and touch ►   .</p> <p>Try opening and closing the door again.</p> <p>Reposition the load, make sure the load is correctly in the drum and that protruding items are not stopping the door from closing.</p>
The pump filter is blocked	<i>Ɛ L r F L E r</i>	<p>Machine will stop and flash <i>Ɛ L r F L E r</i> if the water is not draining out of the drum. This can be caused by foreign objects or a build up of lint in the pump or filter. Clean the filter, refer to 'Caring for your washer dryer' on how to remove the filter (if the machine is in the middle of a cycle and has a drum fill of water a lot of water might come out).</p> <p>Run a 'Drum Clean' cycle to flush out any residue or lint that may be caught in the machine after cleaning out the filter. If this happens often, clean the filter out regularly.</p>
Machine is cooling down	<i>Ɛ o o L</i>	<p>The machine is performing a cool down to reduce the temperature inside the drum so it is safe to open. This time can vary depending on a number of factors. Let the machine perform this cool down period so it is safe to access items of clothing.</p> <p><i>Ɛ o o L</i> will be displayed at the end of a drying cycle, if the 'Add a garment' button is selected and if ►   is pushed.</p>

Once you have addressed the user warning try using your washer dryer as per usual. If the symptom persists, call your Fisher & Paykel trained and supported service technician.

## FAULT CODES

---

**When a continuous series of beeps is sounded, all the lights turn off on the control panel and a number appears on the display, a fault has occurred.** The washer dryer will automatically enter this mode if a fault occurs. The fault code will be displayed as *E r r* followed by a number on the digital display. To stop the sound, touch any button and perform the following steps:

- ① Turn your machine off at the power point.
- ② Wait one minute and turn it back on.
- ③ Check your machine is correctly levelled (refer to page 12).
- ④ Remove your load.
- ⑤ Perform a 'Rinse' cycle.
- ⑥ If the fault re-occurs repeat steps ① and ②.
- ⑦ If the machine still will not work you will be required to call a Fisher & Paykel trained and supported service technician to arrange service (refer to the 'Customer Care' section). Record the fault code number displayed and the serial number of your washer dryer (located on the rear of the machine, and/or above the drum opening when the door is open) before calling. The fault code will indicate to the Fisher & Paykel trained and supported service technician what the problem could potentially be.

If a fault code is being displayed, you can still turn your washer dryer off by pressing 'POWER'.

## TROUBLESHOOTING

The following is a list of problems you may encounter when using this appliance and some suggestions that may help to correct the problem. If you still have problems, please contact your Fisher & Paykel trained and supported service technician.

### Solving general operating problems

PROBLEM	POSSIBLE CAUSES	WHAT TO DO
<b>Washer dryer not turning on</b>	Electrical cord not plugged into a power socket.	Plug cord into a power socket.
	Power not switched on at the wall.	Switch the power on at the wall. Then touch 'POWER'.
	Household power supply not working.	Try plugging another electrical appliance into the same socket. Turn off the power at the power point. Unplug the washer dryer from the power socket. Wait 60 seconds, plug it back in, turn it on and try again.
	'Keylock'  may be activated.	Touch and hold the 'POWER' button for 2 seconds. Refer to page 37.
<b>Touching ►   does not start filling or drying</b>	Washer dryer door not closed properly.	Open and reclose door.
	The washer dryer has detected a fault.	Check if a code is being displayed on the panel. (Refer to pages 40 – 42).
	Cold tap turned off.	Check that the cold tap is turned on.
	Blocked hose filter.	Check the tap end of the inlet hose for blockages.
	Inlet hose leaking, twisted or damaged.	Check the inlet hose for leaks or damage. Check that the inlet hose is not twisted.
	Faulty water supply.	Check the cold tap is connected to the machine and is working.
	'Delay Start' may be set.	Refer to page 35.
<b>Washer dryer is paused</b>	►   light is flashing.	Touch the ►   button to resume the cycle.

## TROUBLESHOOTING

### Solving general operating problems

PROBLEM	POSSIBLE CAUSES	WHAT TO DO
<b>Washer dryer stops working mid cycle</b>	The washer dryer has detected a fault.	Refer to pages 40–42.
	Power or water failure.	Check the power and/or water is working correctly.
	Washer dryer has been paused.	Touch the ►   button to continue.
	Too many suds.	Washer dryer is waiting for suds to dissolve before continuing the cycle.
<b>Vibrating</b>	Transit bolts left in place.	Ensure transit bolts are removed prior to use of the product (refer to page 10).
	Washer dryer may not be level.	Ensure washer dryer is installed on an appropriate surface and levelled correctly (refer to page 12).
	Load is out of balance.	Wash an average sized load rather than a smaller load or a single item. Washing or drying one item at a time is not recommended as it is difficult for the washer dryer to balance a single item during spin.
<b>Small puddle of water from under the machine</b>	Inlet hose or drain hose leaking.	Check inlet hose and the drain hose are correctly attached and not damaged.
	Lots of suds.	Suds may have leaked and then dissolved.
	Detergent dispenser blocked.	Clean detergent dispenser drawer (refer to page 37).
	Detergent dispenser drawer not fully closed.	Close detergent dispenser drawer fully and ensure it remains closed during the cycle.
	Damage to door seal.	Check seal inside door for damage. If it sustains any damage it will need to be replaced.
<b>Washer dryer keeps stopping and starting</b>	The 'Wrinkle Free' option has been selected.	Refer to page 33 for more information.

## TROUBLESHOOTING

### Solving general operating problems

<b>PROBLEM</b>	<b>POSSIBLE CAUSES</b>	<b>WHAT TO DO</b>
<b>Not spinning properly</b>	Load has gone out of balance.	Open door and redistribute load, then restart the washer dryer.
	Machine is not level.	Ensure machine is correctly levelled (refer to page 12).
	Suds build up.	Check the amount of detergent used, reduce if necessary (refer to pages 27 - 28).
<b>Detergent or fabric softener remaining in detergent dispenser at the end of the cycle</b>	Detergent drawer not properly closed or was opened part way through the cycle.	Ensure the detergent dispenser drawer is fully closed at the start of the cycle and remains closed throughout the cycle.
	Dirty or blocked detergent dispenser.	Clean the detergent dispenser (refer to page 37).
	Liquid sitting at the 'Max' level at the end of the cycle indicates a blockage.	Clean the fabric softener dispenser (refer to page 37).
	Dispenser over loaded with detergent.	Clean out remaining detergent (refer to pages 27 - 28 for dosing information).
<b>Black or grey marks on clothes</b>	Correct amount of detergent.	Ensure the correct dose of detergent is used for the load size and soil level (refer to page 27).
	Washer dryer needs to be cleaned.	Empty the machine and complete a 'Drum Clean' cycle (refer to page 37).
<b>Tangling</b>	Items not sorted correctly.	Separate larger items from smaller items.
	Washer dryer loaded incorrectly.	Load items loosely and individually into the washer dryer (ie not folded).
	Incorrect cycle for load type selected.	Use the 'Synthetic' cycle to wash shirts.
	Washer dryer overloaded in terms of its capacity or the cycle selected.	Try washing average to smaller load sizes.

## TROUBLESHOOTING

### Solving washer problems

PROBLEM	POSSIBLE CAUSES	WHAT TO DO
<b>Washer dryer drains while filling</b>	Drain hose too low.	Ensure the height of the drain hose is at least 800mm from the floor level (refer to page 14).
	Drain hose sitting in water.	Clear the drain.
<b>Washer dryer is not draining</b>	Drain hose blocked.	Clear the drain hose.
	Pump filter blocked.	Clear the pump filter (refer to page 38).
	Drain hose higher than 1200mm above floor level.	Lower the level of the drain hose (refer to page 14).
<b>Filling continuously</b>	Drain hose not connected to standpipe or tub.	Connect drain hose correctly (refer to page 14).
	Machine siphoning.	Ensure standpipe or tub is at least 800mm from the floor level.
<b>Poor rinsing</b>	Incorrect detergent used.	Use low sudsing, front loader detergent only (refer to page 27).
	Too much detergent used.	Ensure the correct dose of detergent is used for the load size and soil level (refer to page 28).
<b>Cycle time longer than usual/Inaccurate time reading/ Adjustment of time remaining during cycle</b>	The wash and drying time is approximate.	Wash and drying time may be influenced by a number of factors (refer to page 21).
	Low water pressure or flow rate.	Ensure that the inlet hose filter is not blocked.
	Out of balance or oversudsing.	Recovery from out of balance or oversudsing will extend cycle time (refer to page 40).
	Washing a large load.	Be aware that it will take longer for the machine to fill.
	Selecting various options.	Be aware that some options will extend cycle time.
<b>Dye transfer</b>	Coloured items not washed separately from white/light coloured items.	Remember to separate whites and colours.
	New or non-colourfast items not washed separately.	Wash non-colourfast items separately and select 'Cold' wash temperature.
	Wet items have been left sitting for too long.	Remove items from washer dryer as soon as the cycle is finished, or if items are not to be removed from the washer dryer immediately, select 'Wrinkle Free'.
	Wash temperature.	Consider the wash temperature you select for your coloured items. Lower the temperature if you are concerned.



## TROUBLESHOOTING

### Solving washer problems

<b>PROBLEM</b>	<b>POSSIBLE CAUSES</b>	<b>WHAT TO DO</b>
<b>Too many soap suds</b>	Incorrect type of detergent used.	Use low sudsing, front loader detergent only (refer to page 27).
	Too much detergent used.	Ensure the correct dose of detergent is used for the load size and soil level (refer to page 28).
<b>Poor soil Removal</b>	Incorrect wash cycle selected.	Select a wash cycle that is appropriate for the amount of dirt (refer to pages 23–26).
	Insufficient detergent.	Ensure the correct dose of detergent is used for the load size and soil level (refer to page 28).
	Washer dryer overloaded.	Ensure the washer dryer is not overloaded in terms of its capacity or the cycle selected (refer to pages 23–26).
	Load was particularly dirty.	Select 'Pre Wash' for particularly dirty loads (refer to page 33).
	Items not sorted correctly.	Wash heavily and lightly soiled garments separately.
	Washer dryer dirty from previous wash or dry cycle.	After washing particularly dirty clothing, we recommend putting the washer dryer through a 'Rinse' cycle after the load has been removed, to wash away any remnants of dirt and to prevent it contaminating future wash or dry cycles.
	Incorrect wash temperature selected in relation to the type of soil.	Select a wash temperature suitable for the type of soil, eg warm for greasy soils, cold for muddy soils. Increasing the wash temperature generally improves soil removal and overall wash performance.
<b>Washing very wet at the end of the cycle</b>	Cycle selected not appropriate.	Particularly short or delicate cycles have shorter spins which can result in wetter washing at the end of the cycle.
	Incorrect spin speed for load selected.	Select a faster spin speed.
	An out of balance load has occurred.	The washer dryer compensates for the out of balance by using a lower spin speed, to reduce noise and potential damage to itself.

## TROUBLESHOOTING

### Solving dryer problems

PROBLEM	POSSIBLE CAUSES	WHAT TO DO
<b>Dryer does not heat</b>	Dryer set to 'Air Dry' cycle.	Check what cycle the dryer is set to, change to the preferred cycle (refer to pages 30–34).
	The dryer has progressed to cool.	The dryer will progress and display <b>□ □ □ L</b> (refer to page 34).
<b>Dryer is taking too long/results were not satisfactory</b>	Drying cycle selected not appropriate for the load.	Select an appropriate cycle for the load (refer to pages 23–26).
	'Dryness Level' selected not appropriate for the load.	Select a higher dryness level (refer to pages 23–26).
	Dryer overloaded for the cycle.	Each cycle has a maximum load size (refer to page 31).  Try dividing the load in two and dry half at a time.
	Environmental conditions may be affecting dryer operation.	In hot, humid conditions the dryer will take longer to dry a load and be less efficient.
	Dryer not draining water properly.	Check the drain hose for blockages or damage. You may need to call for service (refer to page 38).
	Items got wrapped up inside other items.	Try separating items and drying similar items together. Open items out when you place them in the dryer. Do not fold them up. Untangle items, eg pull long sleeves out so they are not stuck/trapped on the inside of the garment.
<b>Clothes getting too hot or damaged</b>	Cycle selected not appropriated for the load.	Ensure the cycle selected is appropriate for items in the load (refer to pages 23–26, 30 and 31).
	Items removed from dryer before the end of cycle cool down had finished.	Removing items before cool down may damage clothing if it is not spread out and exposed to air to cool once removed from the dryer.
<b>Cycle time longer than usual</b>	Cycle time may be affected by a number of factors and is approximate.	Cycle time is affected by the size and composition of the load, how wet/dry the load was to begin with, the environmental conditions the dryer is operating in, cycle options selected, sensing while drying and any interruptions during the cycle (refer to page 21).

## TROUBLESHOOTING

### Solving dryer problems

<b>PROBLEM</b>	<b>POSSIBLE CAUSES</b>	<b>WHAT TO DO</b>
<b>Linting</b>	Washer dryer is overloaded.	Remove some items from the washer dryer, cycles have certain capacity limitations (refer to pages 30 and 31).
	Loads not sorted correctly.	Dry lint gives separately from lint receivers. Dry similar colours together eg light coloured items with light coloured items, dark items with dark coloured items (refer to pages 23-6).
	Clothes over dried.	Over drying clothes in the dryer can cause them to attract lint. Use an auto sensing cycle or ensure you check your load if using the 'Time Dry' cycles to avoid over drying (refer to pages 23-26).
	New items have been dried in the washer dryer recently.	New towels or flannelette sheets can leave lint in the dryer, which may be picked up by subsequent loads.
<b>Fabric damage</b>	Delicate items not dried on an appropriate cycle.	Dry delicate items on a 'Delicate' cycle (refer to pages 24, 30 and 31).
	Metal parts on the items or in the load.	Fasten zips and other clasps before placing items in the washer dryer.
	Items not separated or dried on an appropriate cycle for the fabric type.	Dry similar items together. Ensure an appropriate cycle is selected (refer to pages 23-26).
	'Dryness Level' selected not appropriate for the fabric type.	Ensure the 'Dryness Level' selected is appropriate for the fabric type. Refer to the items care label (refer to pages 30 and 31).
	Instructions on care label not followed.	Follow the instructions on the care label of the items.

## TROUBLESHOOTING

### Solving dryer problems

<b>PROBLEM</b>	<b>POSSIBLE CAUSES</b>	<b>WHAT TO DO</b>
<b>Creasing</b>	Washer dryer overloaded.	Do not overload washer dryer.
	Incorrect cycle for load type.	Use specified cycle for particular load type and add on 'Wrinkle Free' option to your cycle.
	Spin speed too fast.	Select a slower spin speed.
	Wet clothes left in washer dryer or laundry basket.	Laundry left sitting wet is more likely to crease. If not removing clothes from washer dryer immediately at end of cycle, select the 'Wrinkle Free' option. Do not leave wet washing sitting in a washing basket.
	Wash temperature too hot for load type.	Select a lower wash temperature. Check items care label for correct care.
	Items not sorted correctly.	Sort load so that items of similar weight are washed and dried together (refer to pages 23-26).

## CONSUMPTION DATA TABLE

MODEL	CYCLE	TEMP. (°C)	LOAD (kg)	PROGRAMME TIME ON DISPLAY (min)	REMAINING MOISTURE CONTENT (%)	ENERGY CONSUMPTION (kWh/CYCLE)	WATER CONSUMPTION (L/CYCLE)
WD8060P1	Cottons Eco*	60	7	335	44	0.78	51
	Cottons	40	7	142	58	1.06	73
	Everyday	40	7	64	47	0.67	70
	Heavy	60	7	135	61	1.67	91
	Towels	40	5	60	62	0.66	74
	Synthetic	40	4	127	38	0.93	53
	Delicate	40	4	45	64	0.29	63
	Quick Wash 30	40	4	30	67	0.36	58

Tested on default settings. Values are approximate only. Consumption will depend on how the washer is used. Actual values can vary depending on water pressure, water hardness, water inlet temperature, room temperature, environmental conditions, type and size of load, fluctuation in electricity supply and options selected.

\* Values measured in accordance with EN 60456 and EU Regulation 1061/2010.

**PRODUCT FICHE ACCORDING TO  
COMMISSION DELEGATED REGULATION (EU) 96/60/EC**

**Fisher & Paykel**

<b>MODEL</b>	<b>WD8060P1</b>
Energy efficiency class on a scale from A (most efficient) to G (low efficient)	A
Energy consumption for washing, spinning and drying, in kWh per complete operating cycle using standard 60 cotton cycle and 'cotton dry' drying cycle	4.79
Energy consumption for washing and spinning in kWh per cycle using standard 60 cotton cycle	0.78
Washing performance class on a scale from A (higher) to G (lower)	A
Water extraction efficiency class on a scale from A (higher) to G (lower)	
Water remaining after spinning in % (as a proportion of dry weight of wash)	44
Maximum spin speed (rpm)	1400
Washing capacity (kg) for standard 60 cotton washing cycle	7.0
Drying capacity (kg) for a standard 'dry cotton' drying cycle	4.0
Water consumption for washing, spinning and drying in litres per complete operating cycle	102
Water consumption for washing and spinning only in litres per cycle using standard 60 cotton cycle	51
<b>Programmes to which the information on the label and fiche leaflets relates: Cottons, 60°C, Eco; Cottons, 40°C, Eco; and Cottons Dry, Dry (dryness level), Eco.</b>	
Washing and drying time. Programme time for complete operating cycle (60 cotton washing and 'dry cotton' drying) for rated washing capacity (min)	600
Washing and spinning only time. Programme time for standard 60 cotton washing cycle for rated washing capacity (min)	338
Estimated annual energy consumption based on 200 complete operating cycle for a four person household, always using the dryer (kWh/year)	958
Estimated annual water consumption based on 200 complete operating cycles for a four-person household, always using the dryer (l/year)	19480
Estimated annual energy consumption based on 200 complete operating cycle for a four-person household, never using the dryer (kWh/year)	156
Estimated annual water consumption based on 200 complete operating cycles for a four-person household, never using the dryer (l/year)	10200
Noise during washing using standard 60 cotton washing cycle according with Directive 86/594/EEC (dBA)	55
Noise during spinning using standard 60 cotton washing cycle according with Directive 86/594/EEC (dBA)	67
Noise during drying using 'cotton dry' drying cycle according with Directive 86/594/EEC	58

**Method of distribution for dry cycle**

The base load shall be divided according to the instruction of the manufacturer.

The rated drying capacity is 4kg including 1 piece sheet and 6 pieces pillowcase and some terry towels, and the others are the load used for the second dry cycle.

# MANUFACTURER'S WARRANTY

---

You automatically receive a 2 year Manufacturer's Warranty with the purchase of this washer dryer covering parts and labour for servicing within the country of purchase.

## **Fisher & Paykel undertakes to:**

Repair or, at its option, replace without cost to the owner either for material or labour any part of the product, the serial number of which appears on the product, which is found to be defective within TWO YEARS of the date of purchase.

You also receive an additional EIGHT YEAR parts only Manufacturer's Warranty on your Direct Drive motor. This additional 8-year Manufacturer's Warranty commences on the day following the expiry of the 2-year Manufacturer's Warranty and excludes the motor controller and labour. Fisher & Paykel will repair (as to parts) or, at its option, replace any Direct Drive motor (but not the motor controller) which is found to be defective within this additional Manufacturer's Warranty period. You will be responsible for any labour costs.

Note: these Manufacturer's Warranties are an extra benefit and do not affect your legal rights.

## **These Manufacturer's Warranties DO NOT cover**

- (A) Service calls which are not related to any defect in the product. The cost of a service call will be charged if the problem is not found to be a product fault. For example:
  - ① Correcting the installation, eg removal of bottom packer and transit bolts (front loading washers), levelling the washer, adjustment of the drain to correct siphoning, noises, crossed, kinked or leaking inlet hose connections, turning on water, noises caused by the waterhammer or power supplies.
  - ② Providing instruction on use of the product or changing the set-up of the product, eg instruction on correct use of detergents and fabric softeners.
  - ③ Replacing fuses in, or correcting house wiring or correcting house plumbing, eg unblocking drains.
  - ④ Correcting fault(s) caused by the user.
  - ⑤ Noise or vibration that is considered normal, eg spin sounds, user warning beeps.
  - ⑥ Correcting damage caused by pests, eg rats, cockroaches, etc.
  - ⑦ Water on the floor due to incorrect loading or excessive suds.
  - ⑧ Blocked pumps, removal of foreign objects/substances from the washer, including the pump and inlet hose filters, eg bra wires, bread tags, nails, grit, scrud, etc.
  - ⑨ Correcting corrosion or discolouration due to chemical attack.
- (B) Defects caused by factors other than:
  - ① Normal domestic use; or
  - ② Use in accordance with the product's user guide.
- (C) Defects to the product caused by accident, neglect, misuse or 'act of God'.
- (D) The cost of repairs carried out other than by a Fisher & Paykel trained and supported service technician or the cost of correcting such repairs.
- (E) Normal recommended maintenance as set out in the product's user guide.

## MANUFACTURER'S WARRANTY

---

- Ⓕ Repairs when the appliance has been dismantled, repaired or serviced by other than a Fisher & Paykel trained and supported service technician or the selling dealer.
- Ⓖ Pick-up and delivery.
- Ⓗ Transportation or travelling costs involved in the repair when the product is installed outside the Fisher & Paykel trained and supported service technician's normal service area.

Nothing in this Manufacturer's Warranty is intended to, or does limit, any rights you may have under law to recover the costs of inspecting or returning the goods to us.

This product has been designed for use in a normal domestic (residential) environment. This product is not designed for any commercial use (whatsoever). Any commercial use by a customer will affect this product's Manufacturer's Warranty.

Service under these Manufacturer's Warranties must be provided by a Fisher & Paykel trained and supported service technician (refer to the 'Customer Care' section at the back of this book). Such service shall be provided during normal business hours. This Manufacturer's Warranty certificate should be shown when making any claim.

### **For Australian customers**

This Manufacturer's Warranty is an extra benefit and does not affect your legal rights. Our goods come with guarantees that cannot be excluded under the Australian Consumer Law. You are entitled to a replacement or refund for a major failure and for compensation for any other reasonably foreseeable loss or damage. You are also entitled to have the goods repaired or replaced if the goods fail to be of acceptable quality and the failure does not amount to a major failure.

**Please keep this user guide in a safe place.**



## CUSTOMER CARE

---

### **Before you call for service or assistance...**

Check the things you can do yourself. Refer to your user guide and check:

- ① Your product is correctly installed.
- ② You are familiar with its normal operation.
- ③ You have read the 'Before you call for service', 'Fault codes' and 'Troubleshooting' sections at the back of the book.

If after checking these points you still need assistance or parts, please refer to your nearest Fisher & Paykel trained and supported service technician, Customer Care, or contact us through our website [fisherpaykel.com](http://fisherpaykel.com).

### **In New Zealand if you need assistance...\***

Call the Fisher & Paykel Customer Care Centre and talk to one of our Customer Care Consultants.

**Toll Free:** 0800 FP CARE or 0800 372 273

**Fax:** (09) 273 0656

**Website:** [fisherpaykel.com](http://fisherpaykel.com)

**Postal address:** Fisher & Paykel Appliances Ltd, PO Box 58550, Botany, Auckland 2163

### **If you need service...\***

Fisher & Paykel has a network of Fisher & Paykel trained and supported service technicians that can carry out any service necessary on your appliance. Our Customer Care Centre can recommend a Fisher & Paykel trained and supported service technician in your area.

### **In Australia if you need assistance...\***

Call the Fisher & Paykel Customer Care Centre and talk to one of our Customer Care Consultants.

**Toll Free:** 1300 650 590

**Fax:** (07) 3826 9298

**Website:** [fisherpaykel.com](http://fisherpaykel.com)

**Postal address:** Fisher & Paykel Appliances Australia Pty Ltd, PO Box 798, Cleveland QLD 4163

### **If you need service...\***

Fisher & Paykel has a network of Fisher & Paykel trained and supported service technicians that can carry out any service necessary on your appliance. Our Customer Care Centre can recommend a Fisher & Paykel trained and supported service technician in your area.

### **In the United Kingdom if you need assistance...\***

Call the Fisher & Paykel Customer Care Centre and talk to one of our Customer Care Consultants.

**Phone:** 08000 886 605

**Website:** [fisherpaykel.com](http://fisherpaykel.com)

**Postal address:** Fisher & Paykel Appliances Ltd, Maidstone Road, Kingston, Milton Keynes, Buckinghamshire, MK10 0BD, United Kingdom

## CUSTOMER CARE

---

If you call, write or contact us via our website please provide: your name and address, model number, serial number, date of purchase and a complete description of the problem. This information is needed in order to better respond to your request for assistance.

Product details can be found on the rear of the machine, and/or above the drum opening (when the door is open).

### Registration

Register your product with us so we can provide you with the best service possible. To register your product visit our website: **[fisherpaykel.com](http://fisherpaykel.com)**

Complete and keep for safe reference:

Model \_\_\_\_\_

Serial No. \_\_\_\_\_

Purchase Date \_\_\_\_\_

Purchaser \_\_\_\_\_

Dealer \_\_\_\_\_

Suburb \_\_\_\_\_

Town \_\_\_\_\_

Country \_\_\_\_\_

## **EUROPEAN DIRECTIVE 2012/19/EU ON WASTE ELECTRICAL AND ELECTRONIC EQUIPMENT (WEEE)**

---

This appliance is marked according to the European directive 2012/19/EU on Waste Electrical and Electronic Equipment (WEEE). By ensuring this product is disposed of correctly, you will help prevent potential negative consequences for the environment and human health, which could otherwise be caused by inappropriate handling of this product.

The symbol  marked on the serial plate, or on the documents accompanying the product, indicates that this appliance can not be treated as household waste. It shall be handed over to the applicable collection point for the recycling of electrical and electronic equipment. Disposal of the appliance shall be carried out in accordance with local environmental regulations for waste disposal.

For more detailed information about treatment, recovery, and recycling of this product, please contact your local city office, your household waste disposal service or your Fisher & Paykel retailer/dealer from whom you purchased this product.

**FISHERPAYKEL.COM**

© Fisher & Paykel Appliances 2019. All rights reserved.

The product specifications in this document apply to the specific products and models described at the date of issue. Under our policy of continuous product improvement, these specifications may change at any time. You should therefore check with your Dealer to ensure this document correctly describes the product currently available.

**NZ AU GB**

**429646D 09.19**