

TOP LOADING WASHING MACHINE

WL1264P1 WL1064P1 WL1064G1 WL9058G1 WL8058G1

**IMPORTANT!**

- Read these instructions carefully before installing.
- Failure to adhere to the following guidance may result in a flood and damage to property.
- A blanking cap must be installed on the hot water inlet if the hose is not connected.
- Place drain hose end into tub or high standpipe and ensure it is a minimum of 900mm from the ground to prevent water siphoning.
- Recommended drainage height is 1000mm.
- Only use the new inlet hose set provided with your washer.

**INSTALLER CHECKLIST**

- Bottom plate installed
- Drainage hose attached and clamped
- Drainage hose threaded through hose guide
- Drainage hose at correct height (900 - 1200mm)
- Hot hose connected to the hot valve marked 'H', or blanking cap installed. Leave cap with customer if not required
- Cold hose connected to the cold valve marked 'C'
- Ensure the hot and cold taps are fully open
- Machine is level
- Test cycle complete
- Complete a HYGIENE cycle with HIGH water level selected, with a half load amount of detergent and run without a load

If you need further assistance, please contact a Fisher & Paykel trained and supported service technician or our Customer Care Centre.

**1 UNPACK**

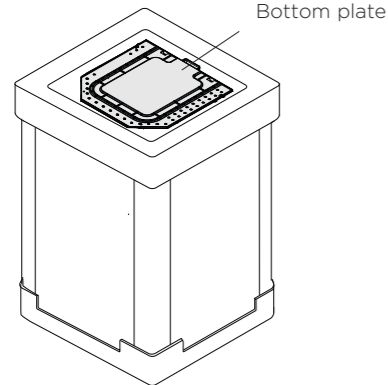

**Remove packing**

- 1 Remove the outer packaging.
- 2 Remove the **bottom plate** from the top packaging.
- 3 Using two people, lift the washer up and away from the base packer. Hold the base packer down while lifting the washer up. Move base packer to side and place the machine gently on floor.
- 4 Lift the lid and remove the drum packer from the drum.
- 5 Remove the hoses and accessories.

**2 INSTALL BOTTOM PLATE**

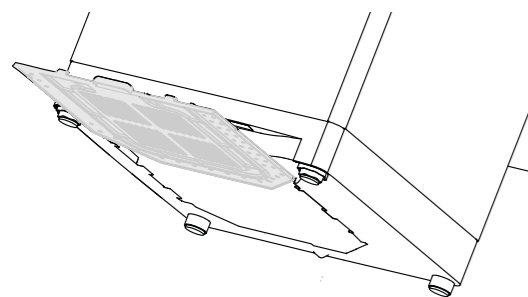

**WARNING! Safety Critical Item**

- 1 Tilt the machine backwards against a supported wall.
- 2 Slide the bottom plate in, click the front tabs into place and screw in.
- 3 Once the screw is tight and the bottom plate is secure, return the washer to it's standing position.

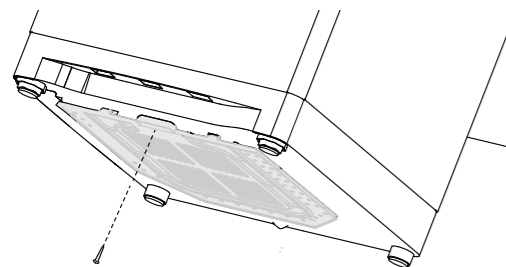

**3 INSTALL DRAIN HOSE**

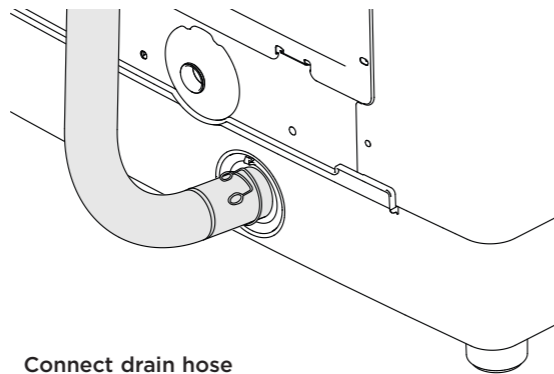

**Connect drain hose**

- 1 Remove the cap of the drain hose outlet.
- 2 Connect the drain hose to the connection point and fasten with provided drain hose clamp.

Note: A small amount of water may come out when the cap is removed.

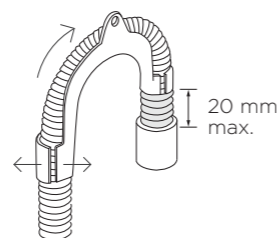

**Connect guide**

- 1 Flex the guide apart and pull the hose through the guide.
- 2 Ensure a maximum of 20mm of the hose is left exposed at the end.
- 3 Secure the hose guide to prevent it dislodging from the tub or standpipe.
- 4 Do not fit the hose to a drain spigot. Drainage must not be airtight in order to prevent siphoning.
- 5 Do not force the drain hose down a standpipe.

Drainage must not be airtight in order to prevent siphoning.  
Do not place hose into a floor drain.

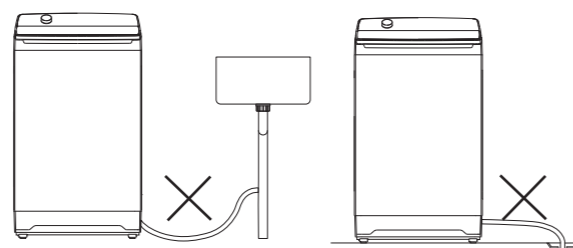
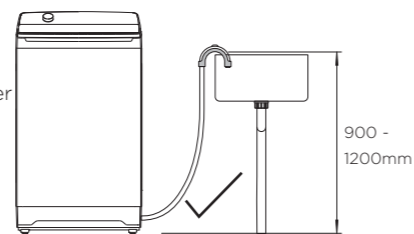

**4 CONNECT WATER SUPPLY**

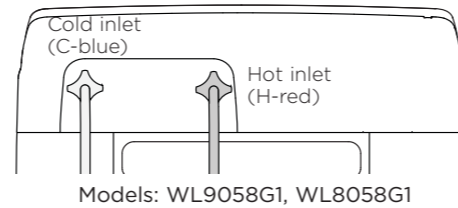
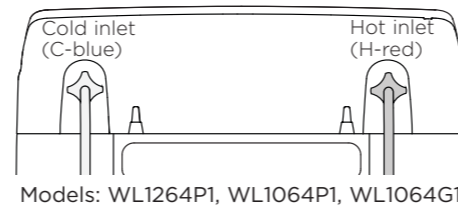

**Connect water**

- 1 Connect the straight end of the inlet hoses to the taps.
- 2 Connect the elbow end to the corresponding washer inlet valve.
- 3 Tighten the inlet hose end by hand until the hose seal just makes contact with the tap-sealing face. Continue to tighten a further half-turn.
- 4 Make sure there are no kinks in the hoses.
- 5 **Fully open** both taps to turn on and check for leaks. Check for leaks again after 24 hours.

**5 INSTALL HOT INLET BLANKING CAP**  
(When hot hose is not connected)

**IMPORTANT!**

If you are connecting to cold water supply only:

- Attach the inlet blanking cap to the hot water inlet to prevent leaking.
- The blanking cap can be found in the installation bag supplied with the product.

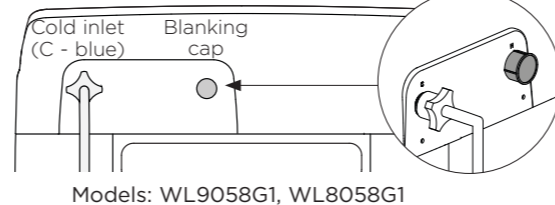
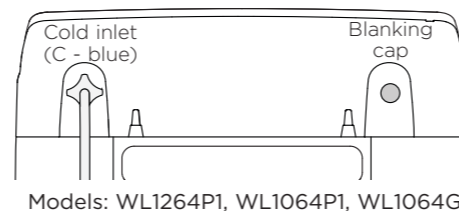

**6 LEVEL MACHINE**

It is **IMPORTANT** to level the washer to ensure good spin performance.

- Your washer is equipped with self adjusting feet at the rear and adjustable feet at the front.
- To adjust the front feet, pull down then twist.
- Ensure they do not move once you have levelled the washer by hand-tightening the locknut's.
- After levelling, the corners of the washer should be clear of the floor and must not rock in any direction.

- 1 Move the washer to its final position allowing for 20mm on each side and 50mm at the rear of machine.
- 2 Close the lid and tilt washer forward away from wall to release the rear feet.
- 3 Gently lower washer back down.

**Level the washer side to side:**

- 4 Check whether washer rocks from side to side. Adjust front feet to correct any rocking. Open the lid and check the drum is in a central position.

**Level the washer front to back:**

- 5 Open the lid, check the drum is still in a central position.
- 6 Adjust front feet to correct any rocking. There should be equal weight on both front feet. There must be no rocking in any direction, and the drum must be in a central position.
- 7 If the washer is not level repeat the above steps.
- 8 Once level, hand tighten the locknut's on the front feet.

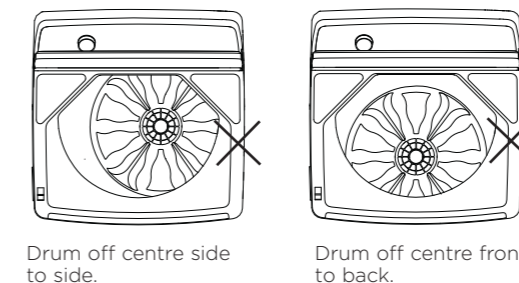
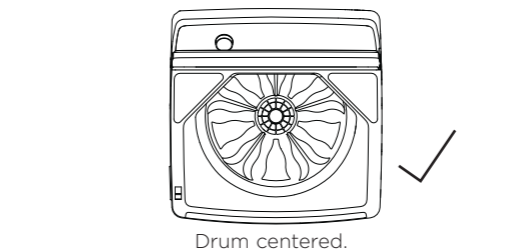

**7 TEST CYCLE**

**Complete the installation**

- Turn on the water and check all hose connections for leaks. Ensure there are no kinks in the hoses. Check the hose connections for leaks again after 24 hours.
- Uncoil power cord, remove and discard the plastic pin cover, and plug in to an earthed outlet protected by a fuse of suitable capacity.
- Complete a test cycle with an empty drum.

**POWER**



- 1 Touch **⏻** to activate your washer.



- 2 Select **QUICK** cycle.  
**If no hot hose is connected to the machine, change the water temperature setting to COLD before starting the quick cycle.**



- 3 Touch **▶||** to start the test cycle.

If there are any problems, you must address these before proceeding with normal use. The washer will automatically turn off at the end of the cycle if there are no problems.

**8 HYGIENE CYCLE**

Inform the customer to run a **HYGIENE** cycle after the completion of the **QUICK** cycle to remove any residues remaining from the manufacturing process. Select high water level, use a half-load amount of detergent and run the cycle without a load.

For setups with **BOTH** hot and cold hose connected:

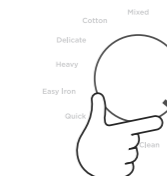

- 1 Select **HYGIENE**. Touch **▶||** to start.

For setups with **ONLY** a cold hose connected

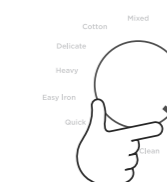

- 1 Select **HYGIENE**. Change the water temperature to **COLD**. Touch **▶||** to start.