

FISHER & PAYKEL

**TOUCH CONTROL
CERAMIC GLASS COOKTOPS**

CE604DTB, CE704DTB and CE754DTB models

INSTALLATION GUIDE / USER GUIDE

NZ AU

CONTENTS

Safety and warnings	2
Installation instructions	8
Introduction	14
Using your cooktop	16
Using your cooktop's special features	20
Cooking guidelines	25
Care and cleaning	28
Troubleshooting	30
Warranty and service	32

IMPORTANT! **SAVE THESE INSTRUCTIONS**

The models shown in this user guide may not be available in all markets and are subject to change at any time. For current details about model and specification availability in your country, please go to our website www.fisherpaykel.com or contact your local Fisher & Paykel dealer.

SAFETY AND WARNINGS

Your safety is important to us. Please read this information before using your cooktop.

Installation

⚠ WARNING!



Electrical Shock Hazard
Disconnect the appliance from the mains electricity supply before carrying out any work or maintenance on it.
Connection to a good earth wiring system is essential and mandatory.
Alterations to the domestic wiring system must only be made by a qualified electrician.
Failure to follow this advice may result in electrical shock or death.

⚠ WARNING!



Cut Hazard
Take care - some edges are sharp.
Failure to use caution could result in injury or cuts.

IMPORTANT SAFETY INSTRUCTIONS

Installation

- **Read these instructions carefully before installing or using this appliance.**
- **No combustible material or products should be placed on this appliance at any time.**
- **Please make this information available to the person responsible for installing the appliance as it could reduce your installation costs.**
- **In order to avoid a hazard, this appliance must be installed according to these instructions for installation.**
- **This appliance is to be properly installed and earthed only by a suitably qualified person.**
- **This appliance should be connected to a circuit which incorporates an isolating switch providing full disconnection from the power supply.**
- **Failure to install the appliance correctly could invalidate any warranty or liability claims.**

⚠ WARNING!



Electrical Shock Hazard
Do not cook on a broken or cracked cooktop. If the cooktop surface should break or crack, switch the appliance off immediately at the mains power supply (wall switch) and contact a qualified technician. Switch the cooktop off at the wall before cleaning or maintenance. Failure to follow this advice may result in electrical shock or death.

⚠ WARNING!



Fire Hazard
Unattended cooking on a hob with fat or oil can be dangerous and may result in fire. NEVER try to extinguish a fire with water, but switch off the appliance and cover flame, eg with a lid or fire blanket. Do not store items on cooking surfaces. Failure to follow this advice may result in serious burns or death.

⚠ WARNING!



Hot Surface Hazard
During use, accessible parts of this appliance will become hot enough to cause burns. Do not let body, clothing or any item other than suitable cookware contact with the ceramic glass until the surface is cool.

Never leave metal objects on the cooktop as they can become hot very quickly.

Keep children away. Handles of saucepans may be hot to touch. Check saucepan handles do not overhang other cooking zones that are on. Keep handles out of reach of children.

Failure to follow this advice could result in burns and scalds.

⚠ WARNING!



Cut Hazard
The razor-sharp blade of a cooktop scraper is exposed when the safety cover is retracted. Use with extreme care and always store safely and out of reach of children.

Failure to use caution could result in injury or cuts.

Operation and maintenance

IMPORTANT SAFETY INSTRUCTIONS

- **CAUTION:** The cooking process has to be supervised. A short term cooking process has to be supervised continuously.
- Never leave the appliance unattended when in use. Boilover causes smoking and greasy spillovers that may ignite.
- Never use your appliance as a work or storage surface.
- Never leave any objects or utensils other than suitable cookware on the appliance.
- Never use your appliance for warming or heating the room.
- Do not allow children to play with the appliance or sit, stand or climb on it.
- Do not store items of interest to children in cabinets above the appliance. Children climbing on the cooktop could be seriously injured.
- Do not leave children alone or unattended in the area where the appliance is in use.
- Children of less than 8 years old must be kept away from the appliance unless continuously supervised.

IMPORTANT SAFETY INSTRUCTIONS

- **This appliance can be used by children aged from 8 years and above, and persons with reduced physical, sensory or mental capabilities or lack of experience and knowledge, if they have been given supervision or instruction concerning the use of the appliance in a safe way and they understand the hazards involved.**
- **Cleaning and user maintenance shall not be done by children without supervision.**
- **Do not repair or replace any part of the appliance unless specifically recommended in the manual. All other servicing should be done by a qualified technician.**
- **Do not use a steam cleaner to clean your cooktop.**
- **Do not place or drop heavy objects on your cooktop.**
- **Do not stand on your cooktop.**
- **Do not use pans with jagged edges or drag pans across the ceramic glass surface as this can scratch the glass.**
- **Do not use scourers or any other harsh/abrasive cleaning agents to clean your cooktop, as these can scratch the ceramic glass.**
- **If the power supply cable is damaged, it must only be replaced by a qualified technician.**
- **Do not operate your cooktop by means of an external timer or separate remote-control system.**

INSTALLATION INSTRUCTIONS

Cooktop and cutout dimensions

Drawings for illustration purposes only

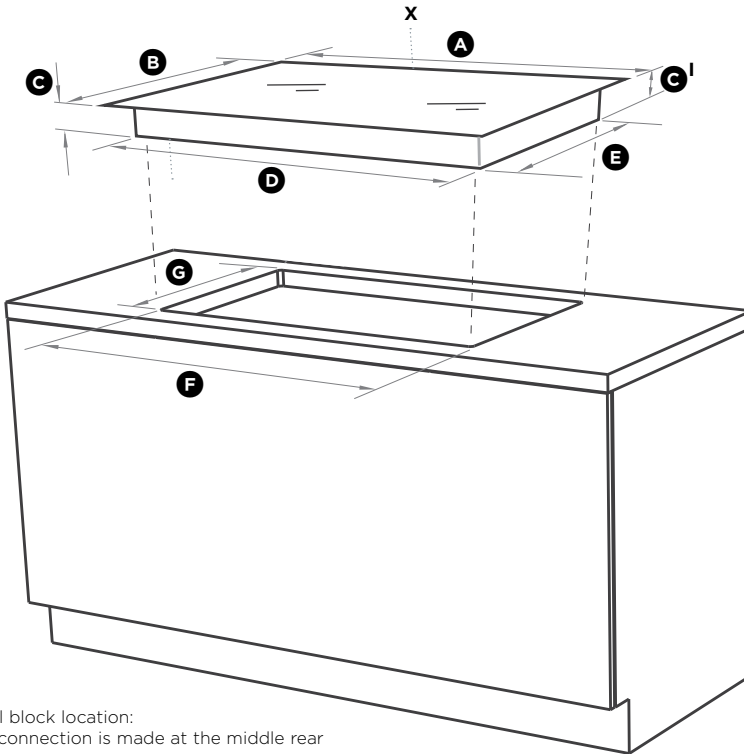

X Terminal block location:
Electrical connection is made at the middle rear

PRODUCT AND CUTOUT DIMENSIONS

	CE604DTB	CE704DTB	CE754DTB
	MM	MM	MM
(A) Overall width of cooktop	600	700	750
(B) Overall depth of cooktop	530	530	530
(C) Height of chassis (below top of bench)	48	48	48
(C') Height of terminal block (below top of bench)	58	58	58
(D) Width of chassis	552	552	715
(E) Depth of chassis	480	480	480
(F) Overall width of cutout	560	560	725
(G) Overall depth of cutout	490	490	490

INSTALLATION INSTRUCTIONS

Clearances

Drawings for illustration purposes only

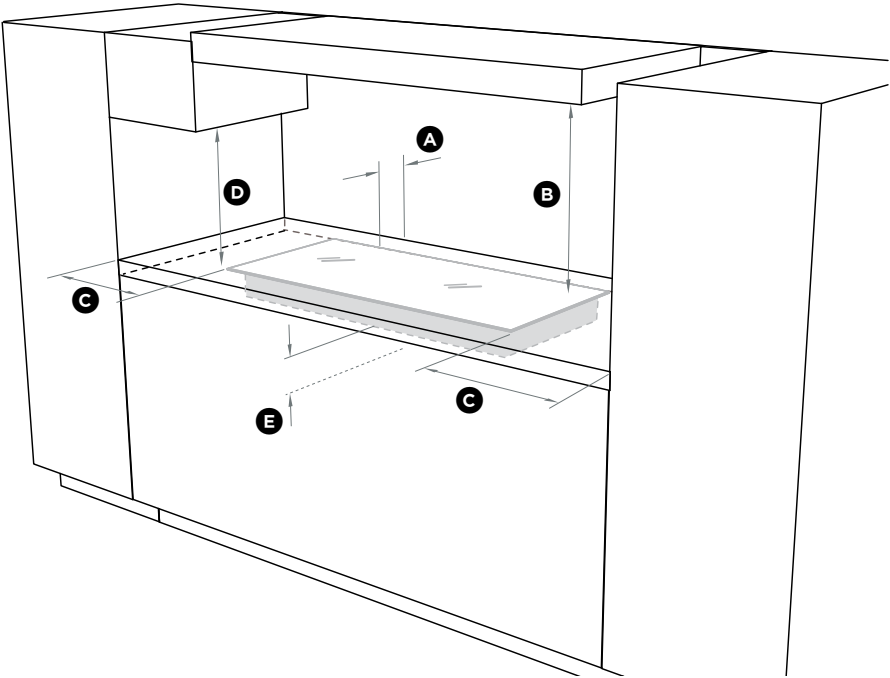

CLEARANCE DIMENSIONS	CE604DTB	CE704DTB	CE754DTB
	MM	MM	MM
(A) Minimum clearance from rear edge of cutout to: nearest combustable surface	55	55	55
(B) Minimum clearance from glass surface to: rangehood	650	650	650
(C) Minimum clearance from side edges of cutout to: nearest combustable surface	85	135	78
(D) Minimum clearance from benchtop to: overhead cabinet not directly above the cooktop	450	450	450
(E) Minimum clearance below top of benchtop to: thermal protection barrier	68	68	68

INSTALLATION INSTRUCTIONS

Before you install the cooktop, make sure that

- the benchtop is square and level, and no structural members interfere with space requirements
- the benchtop is made of a heat-resistant material
- the cooktop will not be installed directly above a dishwasher, as the humidity may damage the cooktop
- the installation will comply with all clearance requirements and applicable standards and regulations
- a suitable isolating switch providing full disconnection from the mains power supply is incorporated in the permanent wiring, mounted and positioned to comply with the local wiring rules and regulations. The isolating switch must be of an approved type and provide a 3 mm air gap contact separation in all poles (or in all active [phase] conductors if the local wiring rules allow for this variation of the requirements)
- the isolating switch will be easily accessible to the customer with the cooktop installed
- you consult local building authorities and by-laws if in doubt regarding installation
- you use heat-resistant and easy-to-clean finishes (such as ceramic tiles) for the wall surfaces surrounding the cooktop.

When you have installed the cooktop, make sure that

- the power supply cable is not accessible through cupboard doors or drawers
- there is adequate flow of fresh air from outside the cabinetry to the base of the cooktop
- if the cooktop is installed directly above an oven or its base is accessible through a cupboard or drawer space after installation, a thermal protection barrier is installed below the base of the cooktop (see below)
- the isolating switch is easily accessible by the customer
- you complete the 'Final checklist' at the end of these installation instructions.

The thermal protection barrier must be:

- removable
- heat-resistant
- made from low thermal conductivity material
- at least 20 mm below the base of the cooktop to ensure adequate ventilation

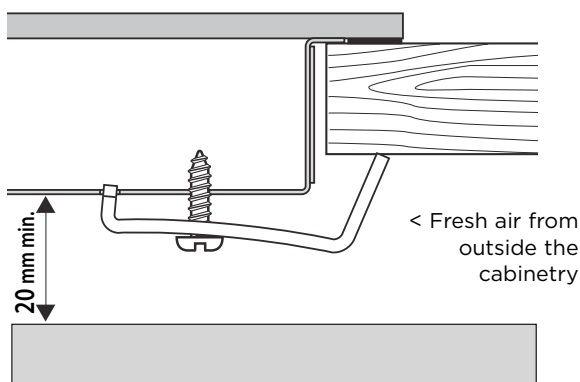

Thermal protection barrier

INSTALLATION INSTRUCTIONS

Fastening the cooktop to the bench

- ① Turn the cooktop upside down and place it on a soft surface.
- ② Spread the seal around the edges of the ceramic glass with the adhesive side facing down, making sure that the whole perimeter is sealed. Cut off any excess material.
- ③ Mount the supplied clamps (A) and screws (B) onto the cooktop, as shown (without tightening the screws).
- ④ Place the cooktop into the cutout, then tighten the screws to clamp the cooktop securely to the bench.
- ⑤ Using a sharp cutter or trimmer knife, trim the excess sealing material around the edge of the cooktop. Take care not to damage the benchtop.

Note: if your bench is thicker than 40 mm, recess the underside to between 30 and 40 mm.

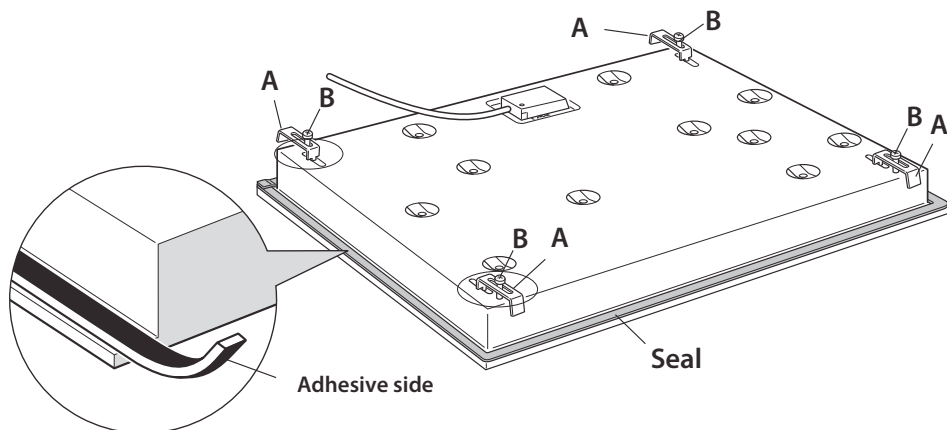

Preparing the cooktop before installation (models may vary)

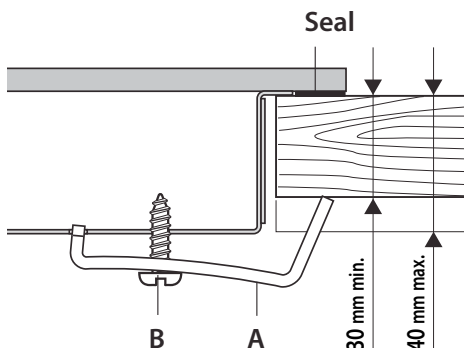

Fastening the cooktop to the bench

INSTALLATION INSTRUCTIONS

Connecting the cooktop to the mains power supply

IMPORTANT!

- This cooktop must be connected to the mains power supply only by a suitably qualified person.
- This cooktop must be earthed.
- Before connecting the cooktop to the mains power supply, check that:
 - the domestic wiring system is suitable for the power drawn by the cooktop
 - the voltage corresponds to the value given on the rating plate
 - the power supply cable sections can withstand the load specified on the rating plate.
- To connect the cooktop to the mains power supply, do not use adapters, reducers, or branching devices, as they can cause overheating and fire.
- The power supply cable must not touch any hot parts and must be positioned so that its temperature will not exceed 75 °C at any point.

Power supply

CE604DTB 6400W @ 220-240/380-415V 2N- (28A)

CE704DTB 6400W @ 220-240/380-415V 2N- (28A)

CE754DTB 7300W @ 220-240/380-415V 2N- (32A)

IMPORTANT!

Check with an electrician whether the domestic wiring system is suitable without alterations. Any alterations must only be made by a qualified electrician.

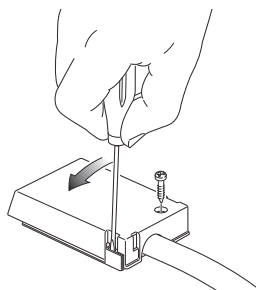

Opening the terminal block cover

Connection diagrams

Single-phase connection

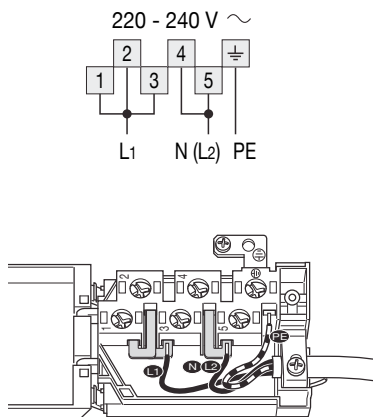

Two-phase connection

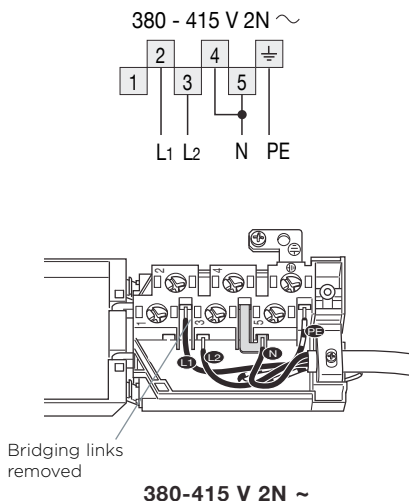

INSTALLATION INSTRUCTIONS



TO BE COMPLETED BY THE INSTALLER

- Is the cooktop earthed?
- Check that the power supply cable is NOT touching the base of the cooktop. This will ensure that the cable is not damaged by heat from the cooktop.
- Check that the power supply cable is not accessible via cupboard doors or drawers.
- Is the cooktop clamped down securely?
- Check that all the cooking zones function correctly. Turn on all of them to a high setting and leave them on for at least one minute.
- Are all elements glowing?
- Are all touch controls and displays functioning?
- To check that the 'hot surface' indicators function correctly, turn off all the cooking zones. Is **H** displayed in all the cooking zone displays?
- Have you shown the customer how to use the cooktop? Make sure you explain to the customer about the 'Hot surface' indicators. Encourage them to read the full user guide before using the cooktop.

Complete and keep for safe reference:

Model

Serial No.

Purchase Date

Purchaser

Dealer Address

Installer's Name

Installer's Signature

Installation Company

Installation Date

INTRODUCTION

About your new cooktop

Thank you for buying a Fisher & Paykel ceramic glass cooktop. This guide introduces you to all its special features. We recommend you read the whole guide before using your new cooktop, for both safety and cooking success.

For more information, visit our website listed on the back cover.

Before using your new cooktop

- Read this user guide, taking special note of the 'Safety and warnings' section.
- Remove any protective film that may still be on your cooktop.

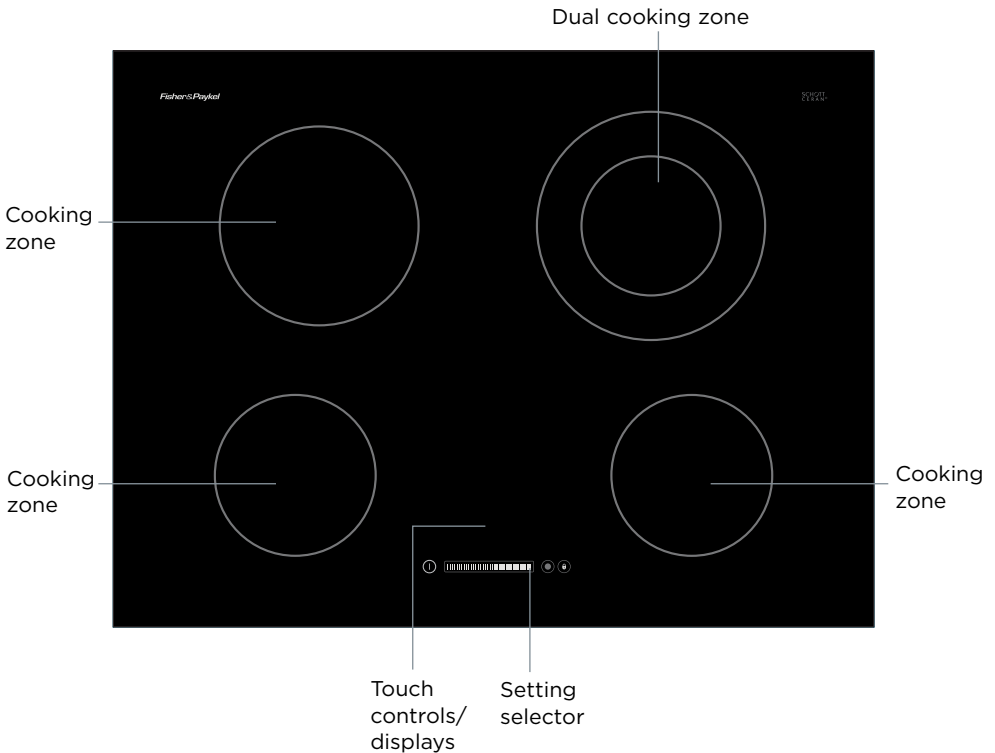

Cooktop layout
(layouts vary)

INTRODUCTION

Touch controls overview

These indicators show which cooking zone(s) the timer is set for:

if flashing:

timer is selected and ready to be set

if steadily lit:

timer is set and counting down

if flashing and beeping:

set time is up

Timer display:

- shows the number of minutes set/remaining
- shows **CL** (cleared) if the timer is not set

if on:

outer section of the dual cooking zone is on

if off:

outer section of the dual cooking zone is off

if on:
cooking zone is selected and ready to be set

if on:
cooktop is on
if off:
cooktop is off

if on:
controls (except ON/OFF) are locked and unresponsive
if off:
controls are responsive

Keylock control:
Locks the controls (except ON/OFF) to prevent unintended use

ON/OFF control

Turns the cooktop on and off

Setting selector:

Touch this area or slide your finger along it to select the heat or timer setting. The lights above the selector correspond to the setting levels (I-9)

Warning!
The cooking zone is not in use but its surface is still very hot!

Dual zone control:

Turns the outer section of the dual cooking zone off and on

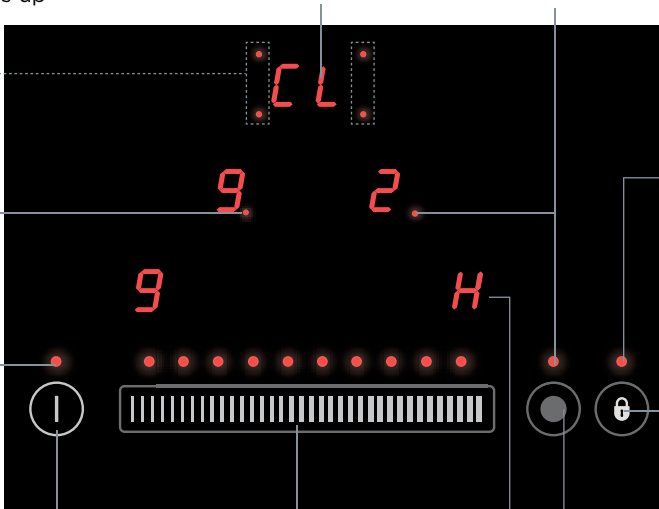

USING YOUR COOKTOP

Using the touch controls

- The cooking zone and timer displays also function as touch controls. To select a cooking zone or the timer, simply touch its display. Use the ball of your finger, not its tip. The controls respond to touch, so you don't need to apply any pressure.
- Once you have selected a cooking zone or the timer, you have 10 seconds to set it (while the little red light at the bottom right of the display is on). If the little red light goes out before you have had a chance to select a setting, simply re-select the cooking zone or timer by touching its display again.
- Make sure the controls are always clean, dry, and there is no object (eg a utensil or a cloth) covering them. Even a thin film of water may make the controls difficult to operate.

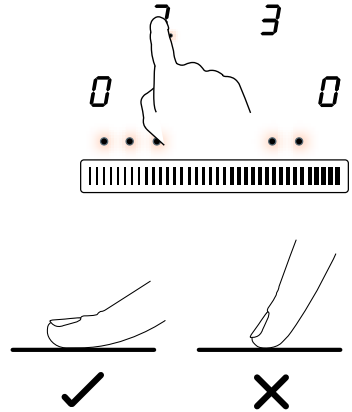

To select a setting on the selector:

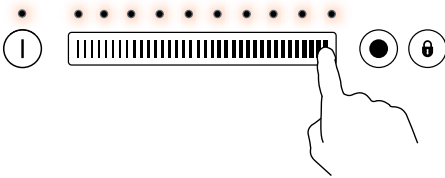

Touch at one point to "jump" to a specific setting

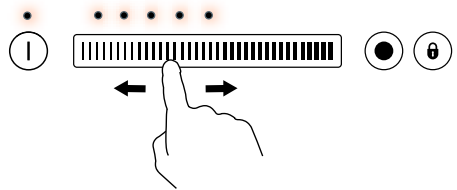

OR

slide your finger along the selector

USING YOUR COOKTOP

To start cooking

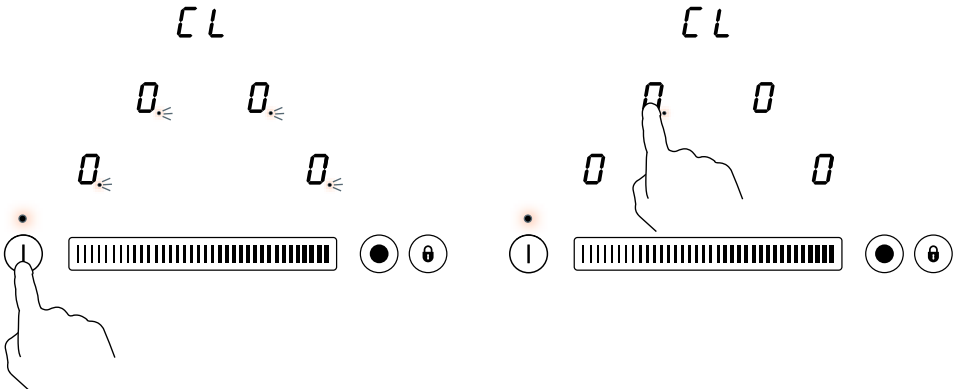

- 1 Turn on the cooktop.

Notes:

- **CL** (cleared) in the timer display means that the timer is not set.
- If you do not select a cooking zone within 20 seconds, the cooktop will automatically turn off.

- 2 Select a cooking zone.

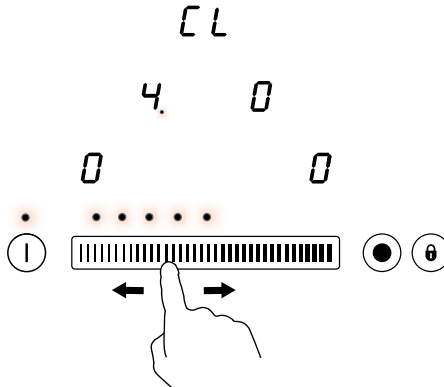

- 3 Select a heat setting (0-9).

Note: setting **u** (between **0** and **1**) provides continuous gentle heat between **0** and **1**. See 'Using your cooktop's special features'.

USING YOUR COOKTOP

To modify the heat setting during cooking

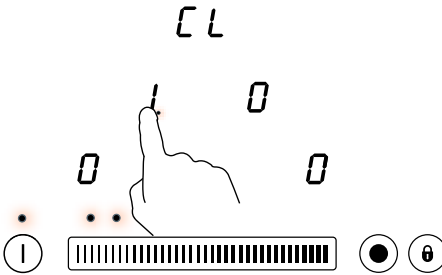

- ① Select a cooking zone.

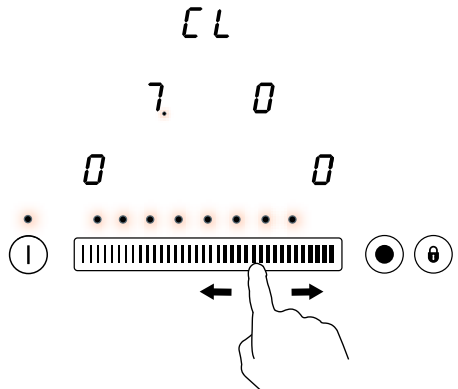

- ② Modify its heat setting.

When you have finished using a cooking zone, you can turn it off, but continue to use other cooking zones:

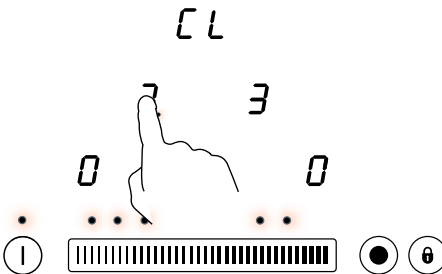

- ① Select the cooking zone you want to turn off.

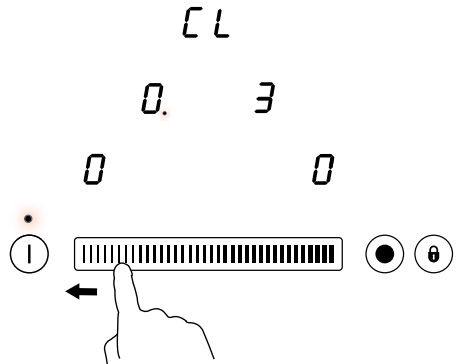

- ② Decrease its heat setting until the display shows **0**. If the cooking zone surface is too hot to touch, **H** will replace **0** in the display.

turn the whole cooktop off:

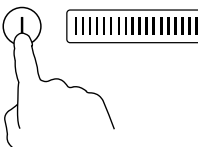

- ① Turn the cooktop off.

H H



- ② **H** will show which cooking zone surface is too hot to touch. It will disappear when the surface has cooled down to a safe temperature.

USING YOUR COOKTOP

Using the dual (right rear) cooking zone

When you turn the dual (right rear) cooking zone on, both the inner and outer sections will heat. Use the ● control to toggle the outer section off or on again.

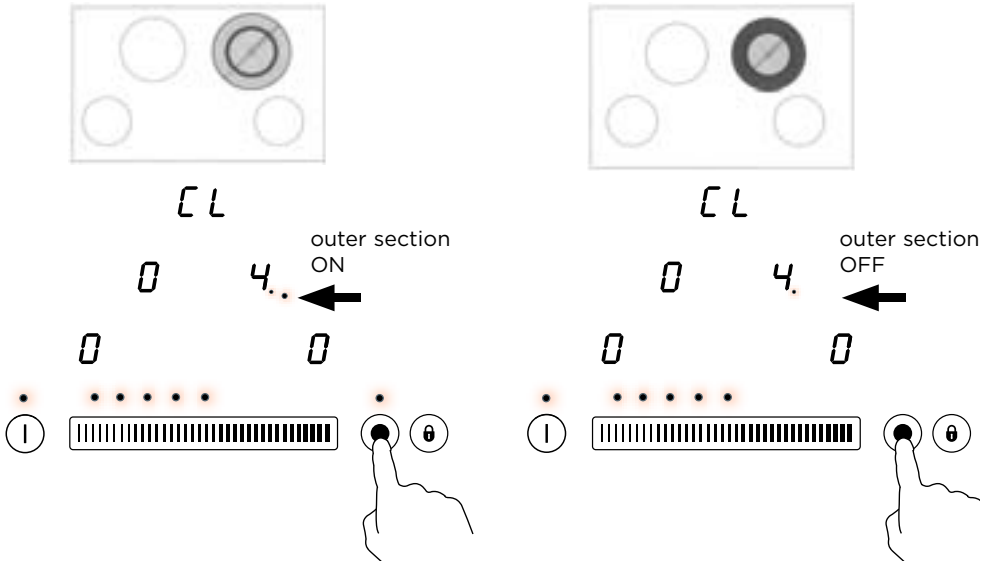

Locking the controls

- You can lock the controls to prevent unintended use (for example children accidentally turning cooking zones on).
- When the controls are locked, all controls except the ON/OFF control are disabled.

To lock the controls

- ① Make sure that the cooktop is turned on but no cooking zone is in use.
 - ② Touch and hold the keylock control (●) for 2 seconds. The red light above the control comes on, indicating that the controls are locked.
- Note: the cooktop will automatically turn off after 10 seconds, but the controls will still be locked when you turn the cooktop on again.

To unlock the controls

- ① Make sure the cooktop is turned on.
- ② Touch and hold the keylock control (●) for 2 seconds. The red light above the control goes out.
- ③ You can now start using your cooktop.

IMPORTANT!

Do not lock the controls while a cooking zone is in use. If you do, you can always turn the cooktop off with the ON/OFF control in an emergency.

USING YOUR COOKTOP'S SPECIAL FEATURES

Using the Auto Heat-reduce feature

Cooking zones set for this feature will:

- first quickly heat up food or liquid at the highest setting
- then automatically reduce the heat to a preset lower setting to cook the food through.

To set a cooking zone for Auto Heat-reduce

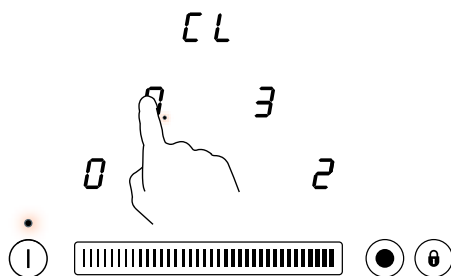

- ① Select a cooking zone.

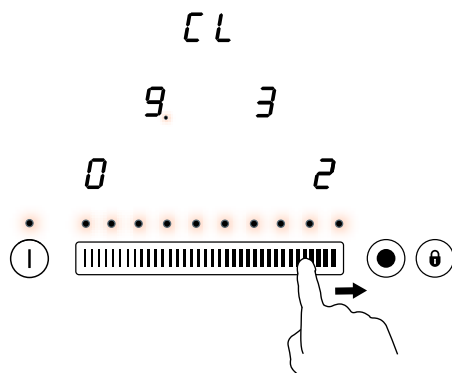

- ② Select heat setting 9.

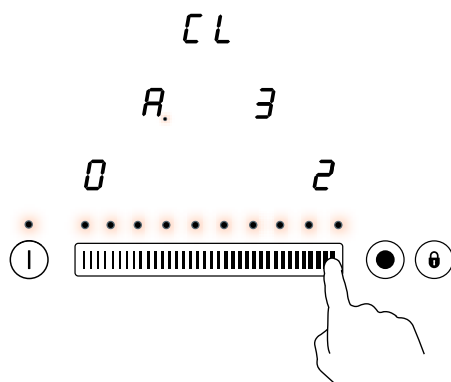

- ③ Re-touch the right end of the setting selector. **A** will start flashing alternately with **9** in the cooking zone's display.

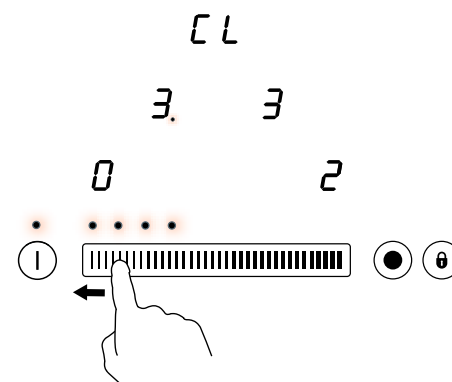

- ④ Choose the lower heat setting you want the cooking zone to automatically reduce to (1-8).

When Auto Heat-reduce is set

Initially, while the cooking zone is at the highest setting, **A** will flash alternately with your selected lower setting. Then, when the period of highest setting is over (eg after 5 minutes), **A** will stop flashing and the cooking zone will automatically reduce the heat to your preset lower setting.

USING YOUR COOKTOP'S SPECIAL FEATURES

PRESET LOWER HEAT SETTING	PERIOD ON HIGHEST SETTING
1	1 minute
2	3 minutes
3	5 minutes
4	6.5 minutes
5	8.5 minutes
6	2.5 minutes
7	3.5 minutes
8	4.5 minutes

To increase or quit the Auto Heat-reduce setting while Ais flashing

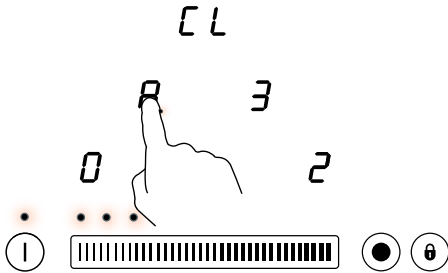

- ① Select the cooking zone already set for Auto Heat-reduce.

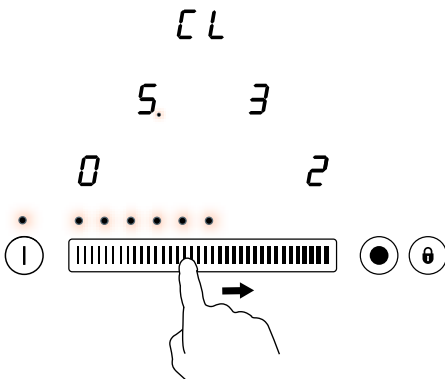

- ② **Increase** the lower heat setting. The period on highest setting will be automatically readjusted.

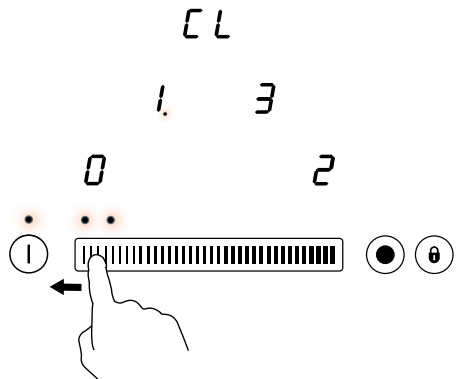

- ② **To quit, decrease** the lower heat setting. Note: if you want to keep using Auto Heat-reduce and reduce the originally set lower heat setting, quit Auto Heat-reduce and set it again.

USING YOUR COOKTOP'S SPECIAL FEATURES

Using the GentleHeat feature

This heat setting between **0** and **1** provides continuous gentle heat and is ideal for:

- delicate cooking tasks such as melting chocolate
- warming plates
- keeping cooked food warm. If reheating cooked food from cold, always bring it to the boil on a higher setting before changing to the GentleHeat setting.
- For food safety reasons, a cooking zone set for GentleHeat will automatically turn off after two hours of continuous use.

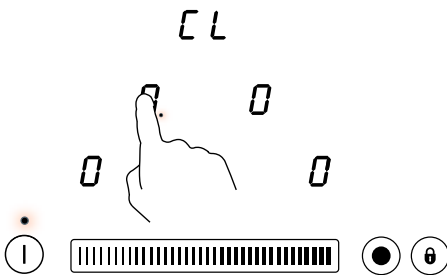

① Select a cooking zone.

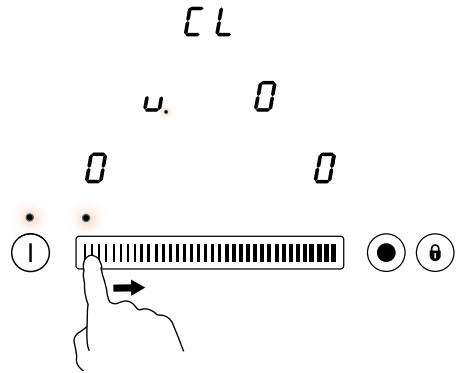

② Select heat setting **u**.

USING YOUR COOKTOP'S SPECIAL FEATURES

Using the timer

You can set the timer to automatically turn one or more cooking zones off when the set time is up.

IMPORTANT!

Never leave the cooktop unattended when in use, even if you have set the timer to automatically turn a cooking zone off.

To set the timer for a cooking zone

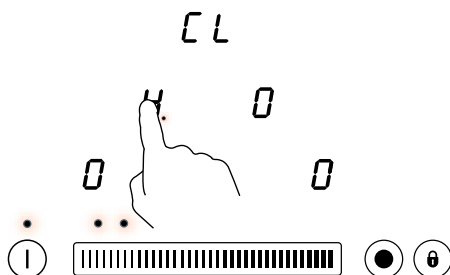

① Select a cooking zone already in use.

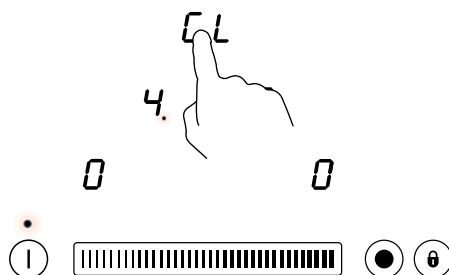

② Select the timer.

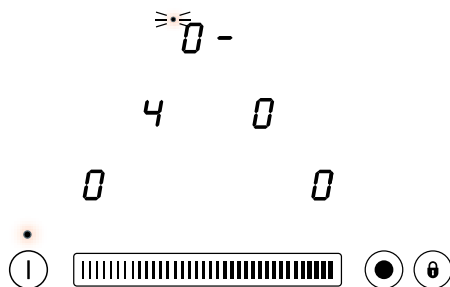

③ The flashing indicator in the timer display means that the timer is ready to be set for the left rear cooking zone.

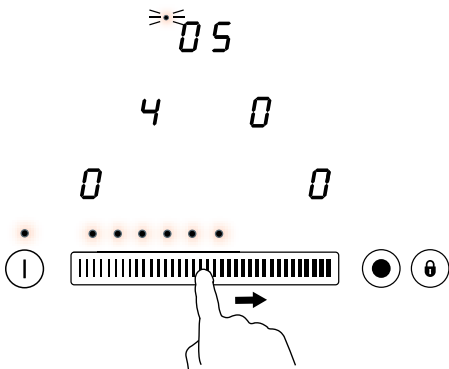

④ Set the right-hand digit using the setting selector.

As an example, you would like to set the timer to turn this particular cooking zone off after 25 minutes.

USING YOUR COOKTOP'S SPECIAL FEATURES

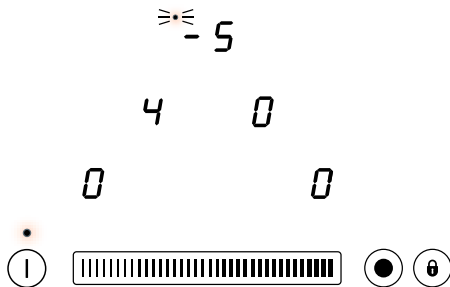

- ⑤ The display will then indicate for you to set the left-hand digit.

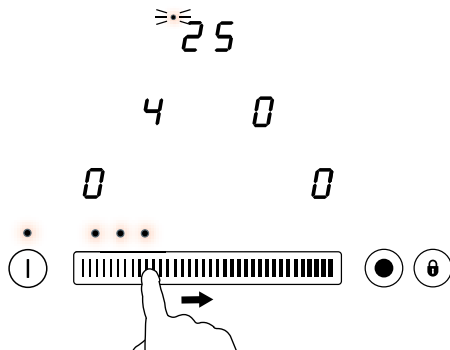

- ⑥ Set the left-hand digit using the setting selector. The timer is now set and begins counting down.

When the set time is up

- The corresponding indicator in the timer display will flash, the timer will beep, and the cooking zone will automatically turn off (its display showing **H** if the surface is hot).
- Touch any control to stop the beeping.

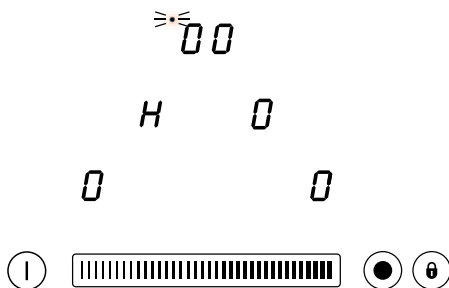

Notes on using the timer

- Skip the last step (6) if you want to set the timer to less than 10 minutes.
- To modify or cancel a timer setting, follow steps 1 and 2 under 'To set the timer for a cooking zone', then modify the number of minutes as wished.
- Once you have set the timer for one cooking zone, you can go on to set it for additional cooking zones by repeating the steps under 'To set the timer for a cooking zone' for each, being mindful of the following:
 - The timer display will always revert to showing the setting for the cooking zone with the shortest remaining time.
 - To check the timer setting for a different cooking zone, simply select the cooking zone. Its remaining time will briefly appear in the timer display.

COOKING GUIDELINES

Cookware

- Use heavy-gauge, flat, smooth-based cookware that matches the diameter of the cooking zone. This will provide good contact with the glass and help reduce cooking times. Low heat or slow cooking is often due to incorrect cookware size.
- Cookware with a stainless steel sandwich base or enamelled cast iron will give you the best results.
- Saucepans or heavy frying pans with jagged edges or a rough base will scratch the glass.
- Always lift pans off the cooktop - do not slide, or they may scratch the glass.
- Never use plastic or aluminium foil dishes on the cooktop.
- Aluminium and copper-based cookware will leave metallic stains on the cooktop. To prevent these building up, clean the cooktop after every use following the instructions in 'Care and cleaning'. If the metallic stains are allowed to burn onto the surface, they may react with the glass and may no longer be removable. They don't, however, affect performance.
- Avoid placing anything on a hot cooking zone until it has cooled completely (H has gone out).
- Avoid placing anything on a hot cooking zone until it has cooled completely.

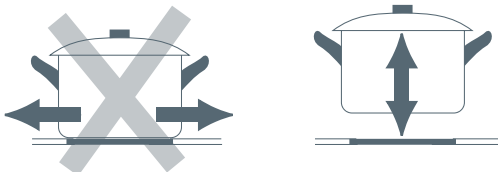
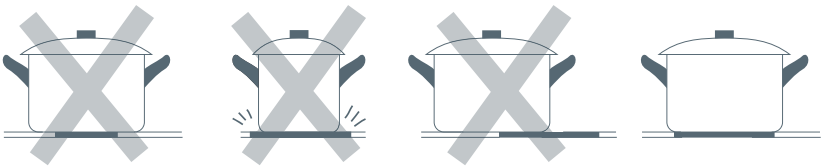
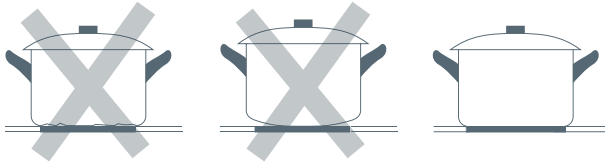

IMPORTANT!

- **Never leave the appliance unattended when in use. Boilover causes smoking and greasy spillovers that may ignite.**
- **Take care when deep-frying: oil or fat can overheat very quickly, particularly on a high setting.**

General cooking tips

- Using a lid will reduce cooking times through retaining the heat.
- Minimise the amount of liquid or fat to reduce cooking times.
- Start cooking on a high setting and reduce it when the food has come to the boil or heated through.
- Even after a cooking zone has been turned off, its glass surface retains enough heat to continue cooking. To avoid overcooking, remove pans from hot cooking zones when the food is cooked.

Cooking rice, simmering

- Some tasks, including cooking rice by the absorption method, may require a setting higher than the lowest setting to ensure the food is cooked properly in the time recommended.
- Simmering occurs below boiling point, when bubbles are just rising occasionally to the surface of the cooking liquid. It's the key to delicious soups and tender stews because the flavours develop without overcooking the food. Egg-based sauces are best kept below boiling point throughout cooking, and flour-based sauces should also be gently simmered after they have reached boiling point.

Searing steak

- ① Stand the meat at room temperature for about 20 minutes before cooking.
- ② Heat up a heavy-based frying pan.
- ③ Brush both sides of the steak with oil and season it to taste.
- ④ Lower the meat onto the hot pan.
- ⑤ Turn the steak only once during cooking. The exact cooking time will depend on the thickness of the steak and how cooked you want it. Times vary between 2 to 8 minutes per side. Press the steak to gauge how cooked it is: the firmer it feels, the more 'well done' it will be.
- ⑥ Leave the steak to rest on a warm plate for a few minutes to allow it to relax and become tender before serving.

For stir-frying

- ① Choose a flat-based wok or a large frying pan.
- ② Have all the ingredients and equipment ready. Stir-frying should be quick. If cooking large quantities, divide the food into several smaller batches.
- ③ Preheat the pan briefly and add two tablespoons of oil.
- ④ Cook any meat first, put it aside and keep warm.
- ⑤ Stir-fry the vegetables. When they are hot but still crisp, turn the cooking zone to a lower setting, return the meat to the pan and add your sauce.
- ⑥ Stir the ingredients gently to make sure they are heated through.
- ⑦ Serve immediately.

COOKING GUIDELINES

Heat settings

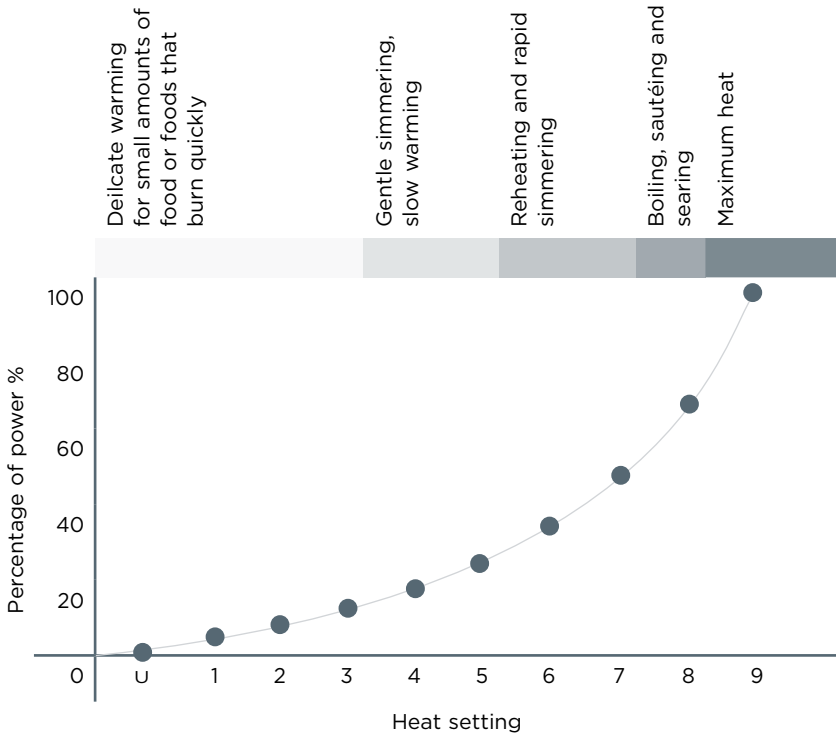

CARE AND CLEANING

IMPORTANT!

- For your safety, switch the power to the cooktop off at the wall before any cleaning. In this case, there will be no 'Hot surface' indication, but the cooking zones may still be hot! Take extreme care.
- Do not use a steam cleaner to clean your cooktop.
- Do not use scourers or any harsh/abrasive cleaning agents to clean your cooktop, as these can scratch the ceramic glass or stainless steel.

WHAT?	HOW?	IMPORTANT!
<p>Light soiling on glass after every use</p> <p>- fingerprints and marks - stains left by non-sugary liquids (eg water, soup, oil)</p>	<ul style="list-style-type: none"> • Wipe with a soft, damp cloth and mild detergent. A microfibre or 'glass' cloth is ideal for this. • Wipe dry with a clean cloth or paper towel. 	<p>Before cleaning, make sure that the glass is a safe temperature to touch.</p>
<p>Non-sugary boilovers, spills and food stains on glass</p> <p>- burnt-on food or grease - pasta water, milk, soup</p>	<ol style="list-style-type: none"> ① Remove the soiling with ceramic cooktop cleaner using a sponge or non-abrasive scourer suitable for ceramic glass. ② Remove any excess cleaner and wipe dry with a clean cloth or paper towel. ③ Apply ceramic cooktop conditioner or protector following the instructions on the dispenser. A microfibre or 'glass' cloth is ideal for this. 	<ul style="list-style-type: none"> • Heavy-duty scourers, some nylon scourers and harsh/abrasive cleaning agents may scratch the glass. Always read the label to check if your cleaner or scourer is suitable. • Never leave cleaner residue on the cooktop: the glass may become stained.
<p>Hot sugary spills, melted plastic or metal on glass</p> <p>- sugar, sugary syrups - jams and jellies - vegetables or vegetable water with high sugar content (peas, sweetcorn, beetroot) - melted aluminium foil or plastic wrap</p>	<p>Remove these immediately with a spatula or razor blade scraper suitable for ceramic glass cooktops, but beware of hot spills and surfaces:</p> <ol style="list-style-type: none"> ① Hold the blade or utensil at a 30° angle and scrape the soiling or spill to a cool area of the cooktop. ② Immediately clean the soiling up with a dish cloth or paper towel. ③ Follow the instructions for 'Light soiling on glass after every use' above. 	<ul style="list-style-type: none"> • Remove stains left by melts and sugary food or spillovers immediately. If left to cool on the glass, they may be difficult to remove or even permanently damage the glass surface. • Cut hazard: the blade in a scraper is razor-sharp when the safety cover is retracted. Use with extreme care and always store safely out of reach of children.

CARE AND CLEANING

WHAT?	HOW?	IMPORTANT!
Metallic stains on glass caused by cookware with - copper base - aluminium base	<ul style="list-style-type: none">• Follow the instructions for 'Non-sugary boilovers, spills and food stains on glass' above.• For stubborn metallic stains, try using a razor blade scraper suitable for ceramic glass cooktops, holding it at a 30° angle.	If the cooktop is not cleaned after every use and copper or aluminium stains are allowed to burn onto the surface, they may react with the glass and no longer be removable. They don't, however, affect performance.
Spillover on the touch controls - food stains - fingerprints and marks	<ol style="list-style-type: none">① Switch the power to the cooktop off at the wall.② Soak up the spill.③ Wipe the touch control area with a clean damp sponge or cloth.④ Wipe the area completely dry with a paper towel.⑤ Switch the power to the cooktop back on at the wall.	<ul style="list-style-type: none">• Immediately wipe off any stainless steel cleaner if it is spilled onto the control dials.• Commercial stainless steel cleaners containing chlorine compounds are corrosive and may damage the appearance of your cooktop. Always read the label to check if your cleaner contains chlorine.

TROUBLESHOOTING

PROBLEM	POSSIBLE CAUSE	WHAT TO DO
The cooktop cannot be turned on.	No power.	Make sure the cooktop is connected to the power supply and that it is switched on at the wall. Check whether there is a power outage in your home or area. If you've checked everything and the problem persists, call your Authorised Repairer or Customer Care.
Cooking zones seem to turn themselves off and on during use.	They cycle off and on to maintain the selected setting or prevent the glass from overheating.	This is normal and needs no action.
The touch controls are unresponsive.	The controls are locked.	Unlock the controls. See section 'Using your cooktop' for instructions.
The touch controls are difficult to operate.	There may be a slight film of water over the controls or you may be using the tip of your finger when touching the controls.	Make sure the touch control area is dry and use the ball of your finger when touching the controls.
There is a metal sheen on the glass.	Cookware with copper or aluminium base.	See 'Care and cleaning'.
The glass is being scratched.	Rough-edged cookware.	Use cookware with flat and smooth bases. See 'Cookware and cooking tips'.
	Unsuitable, abrasive scourer being used.	See 'Care and cleaning'.
The cooktop is continuously beeping and the cooking zone displays read out 	Liquid has spilled onto the touch control area.	Switch the power to the cooktop off at the wall and see 'Care and cleaning' for instructions.
	There are objects (e.g utensils) on the touch control area.	Remove the objects from the touch control area.
	Several touch controls are registering continuous contact (eg due to someone resting their hand or arm on the touch control area).	Remove the cause of continuous contact.

TROUBLESHOOTING

PROBLEM	POSSIBLE CAUSES	WHAT TO DO
The cooktop turns itself off unexpectedly and the cooking zone displays read out E₁H alternating with H .	The cooktop electronics have overheated and the cooktop turns itself off as a safety measure.	Let the cooktop cool down before using it again.
The cooktop turns itself off unexpectedly and no error message or hot surface indication is displayed.	There is a power outage in your home or area.	Wait until the power comes back on.
The cooktop turns itself off unexpectedly and the displays show an error code (a letter and number combination) other than the two explained above.	Technical fault.	Note down the error code, then switch the power to the cooktop off at the wall and contact your Authorised Service Centre or Customer Care with the error code information.
The cooktop cannot be turned off.	Electronics fault.	Switch the power to the cooktop off at the wall and call your Authorised Service Centre or Customer Care.
The cooktop displays do not come on at all or are only partly visible.	Display fault.	Call your Authorised Service Centre or Customer Care.

WARRANTY AND SERVICE

Before you call for service or assistance ...

Check the things you can do yourself. Refer to the installation instructions and your user guide and check that:

- ① Your product is correctly installed.
- ② You are familiar with its normal operation.

If after checking these points you still need assistance or parts, please refer to the Service & Warranty book for warranty details and your nearest Authorised Service Centre, Customer Care, or contact us through our website www.fisherpaykel.com.

Complete and keep for safe reference:

Model _____
Serial No. _____
Purchase Date _____
Purchaser _____
Dealer _____
Suburb _____
Town _____
Country _____

WARRANTY AND SERVICE

This cooktop has been designed and constructed in accordance with the following codes and specifications:

In New Zealand and Australia:

- AS/NZS 60335-1:Current Version
General Requirements for Domestic electrical appliances
- AS/NZS 60335-2-6:Current Version
Particular Requirements for Domestic electrical cooking appliances
- AS/NZS CISPR 14.1.Current Version
Electromagnetic Compatibility Requirements.

FISHERPAYKEL.COM

© Fisher & Paykel Appliances 2017. All rights reserved.

The product specifications in this booklet apply to the specific products and models described at the date of issue. Under our policy of continuous product improvement, these specifications may change at any time. You should therefore check with your Dealer to ensure this booklet correctly describes the product currently available.

NZ AU

599581D / 1105639-BO 10.17