

8kg Series 5 Top Loader Washer, Eco-Active

Series 5 | Top load

White



With room for large loads, this top loader runs on SmartDrive™ technology for a quieter, quicker wash.

- 12 wash cycles including Allergy, Towels, and Bulky
- 4 star energy and water rating
- Includes extra wash feature Soak, for helping to clean tough stains
- Energy saving with Eco-Active™ wash

DIMENSIONS

Height	1045 - 1075 mm
Width	600 mm
Depth	600 mm

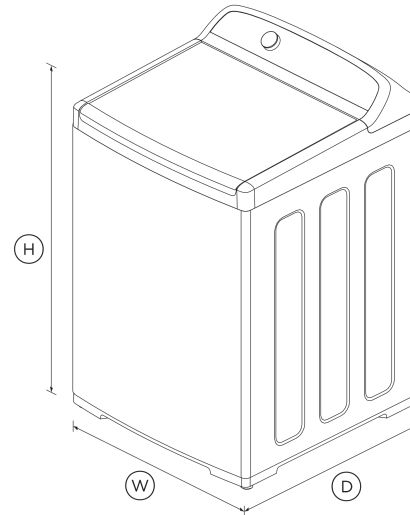

FEATURES & BENEFITS

Smartdrive™ Technology

Our world-first SmartDrive™ technology is made up of just three main parts. This means our washing machines can sense each load, use less water and run with less moving parts for greater reliability.

4-Star Water And Energy

This top loader washing machine features both a 4-star energy rating and a 4-star water rating.

Easy To Use

This machine has a cycle to suit every type of load including Allergy, Sheets and Towels. Select a cycle with the easy-to-use SmartTouch™ control dial.

Easy Installation

Self-levelling feet make installation easy and ensure the washer stays level, to reduce vibration and keep noise to a minimum.

Soft-Close Lid

The robust glass lid has a soft close mechanism that makes it family safe, avoids slamming and allows for hands-free operation.

Robust Construction

Designed with durable, quality materials from the real stainless steel wash basket through to the glass lid.

Perfect Pair

Our washing machines and dryers make the perfect pair. Not only do they care for your clothes, they also look stylish together in your laundry.

SPECIFICATIONS

Capacity

Capacity **8 kg**

Consumption

Energy rating **4 star**
 Energy usage **300kWh/year**
 In-use energy carbon emissions estimate **40.6kgCO2e/year**
 Water consumption per cycle **82L**
 Water rating **4 star (WELS)**

Features

Adjustable alert beeps	•
Agitator	Low profile
Auto out of balance correction	•
Automatic water level	•
Controlled cold	•
Delay start	•
Detergent dispenser	•
Eco rinse	•
Fabric softener dispenser	•
Lid lock	•
No Spin / Spin hold	•
Rinse options	4
SmartTouch™ control dial	•
Soak	•
Soil levels	3
Spin speeds	3
Stainless steel drum	•
Water temperature controls	5

Performance

Auto-Lint disposal	•
Load sensing	•
Maximum spin speed	1100 rpm
Number of spin speeds	3
SmartDrive™ technology	•

Product dimensions

Depth	600 mm
-------	---------------

Height	1045 - 1075 mm
Height (Lid open)	1350 - 1380mm
Width	600 mm

Warranty

Parts and labour	2 years
Parts only SmartDrive™ motor	10 years

Wash Cycles

Allergy	•
Bulky	•
Conventional	•
Delicate	•
Easy Iron	•
Eco-Active™	•
Heavy	•
Number of wash cycles	12
Quick	•
Regular	•
Rinse	•
Sheets	•
Spin	•
Towels	•

SKU	92264
-----	-------

The product dimensions and specifications in this page apply to the specific product and model. Under our policy of continuous improvement, these dimensions and specifications may change at any time. You should therefore check with Fisher & Paykel's Customer Care Centre to ensure this page correctly describes the model currently available. © Fisher & Paykel Appliances Ltd 2020

Other product downloads available at fisherpaykel.com

- [↓ Energy & Water Label](#)
- [↓ Service & Warranty](#)
- [↓ Installation Guide](#)
- [↓ User Guide](#)

Where applicable:

All appliances use energy, and energy usage typically generates carbon emissions. **Fisher & Paykel Appliances' In-use Energy Carbon Emissions Estimate** indicates carbon emissions from a product's in-use energy. This is calculated either annually or per cycle, using the product's market-specific energy label energy consumption data multiplied by the carbon emissions factor for energy in your country or region.

Our In-use Energy Carbon Emissions Estimate is designed to assist customers in making informed purchasing decisions when comparing different Fisher & Paykel products. For example, a heat pump dryer typically has a lower In-use Energy Carbon Emissions Estimate than a vented dryer.



A PEACE OF MIND SALE
24 Hours 7 Days a Week Customer Support

T 0800 372 273 W www.fisherpaykel.com