

# FISHER & PAYKEL

## OVEN

---

### MINIMAL

OB60SMPTDG1, OB60SMPTDB1

### CONTEMPORARY

OB60SDPTDX2

### USER GUIDE

CN



## CONTENTS

---

Safety and warnings	3
Before you begin	8
First use	9
Using the oven light	17
Using the kitchen timer	18
Changing the time	20
Locking the control panel	21
Unlocking the control panel	22
Cooking options	23
Delayed cook	24
Auto off	25
Temperature sensor	26
Guided cooking	29
Cooking guide	31
User preference settings	37
Sabbath Mode	39
Care and cleaning	41
Using Self Clean	51
Troubleshooting	54
Alert codes	57
Food contact materials declaration	58
Manufacturer's Warranty and Service guide	60

---

### Registration

To register your product visit our website: [fisherpaykel.com/register](https://fisherpaykel.com/register)



**⚠ WARNING!**



**Electric Shock Hazard**

**Failure to follow this advice may result in electric shock or death.**

- Turn the oven off at the wall before replacing the oven lamp.
- Before carrying out any work on the electrical section of the appliance, it must be disconnected from the mains electricity supply.
- Connection to a good earth wiring system is absolutely essential and mandatory.
- Alterations to the domestic wiring system must only be made by a qualified electrician.

**⚠ WARNING!**



**Fire Hazard**

**Failure to follow this advice may result in overheating, burning, and injury.**

- Carefully follow the instructions for starting a self-clean cycle.
- Do not place aluminium foil, dishes, trays, water or ice on the oven floor during cooking, this will irreversibly damage the enamel. Lining the oven with aluminium foil may cause fire.
- Never use your appliance for warming or heating the room. Persons could be burned or injured or a fire could start.
- Flammable materials should not be stored in an oven or near its surface.
- Do not use adapters, reducers, or branching devices to connect this appliance to the mains power supply

### ⚠ WARNING!



#### **Cut Hazard**

**Failure to use caution could result in injury.**

- Take care: some edges are sharp.

### ⚠ WARNING!



#### **Hot Surface Hazard**

**Failure to follow this advice could result in burns and scalds.**

- To avoid burns and scalds, keep children away from this appliance.
- Surfaces of the appliance may become hot enough to cause burns. Examples include the oven vent, the surface near the oven vent, and the oven door.
- Do not touch heating elements or interior surfaces of the oven. Heating elements may be hot, even when they are dark in colour.
- Use protection when handling hot surfaces, such as oven shelves or dishes.
- Be careful when opening the oven door. Let hot air or steam escape before removing or replacing food.
- During and after use, do not touch or let clothing or other flammable materials contact heating elements or interior surfaces of the oven until they have had sufficient time to cool.

### READ AND SAVE THIS GUIDE

#### **WARNING!**

To reduce the risk of fire, electrical shock, injury to persons or damage when using the oven, follow the important safety instructions listed below. Read all the instructions before installing or using the oven. Use the oven only for its intended purpose as described in these instructions.

#### **Installation**

- Ensure your appliance is properly installed and earthed by a qualified technician.
- Ensure this oven is connected to a circuit which incorporates an isolating switch providing full disconnection from the power supply.
- Do not install or operate the appliance if it is damaged or not working properly. If you receive a damaged product, contact your dealer or installer immediately.
- Please make this information available to the person installing the appliance—doing so could reduce your installation costs.
- This appliance must be installed and connected to the mains power supply only by a suitably qualified person according to these installation instructions and in compliance with any applicable local building and electricity regulations. Failure to install the appliance correctly could invalidate any warranty or liability claims.
- If the power supply cable is damaged, it must be replaced by the manufacturer, its service agent or similarly qualified person in order to avoid a hazard.
- Isolating switch: make sure this oven is connected to a circuit which incorporates an isolating switch providing full disconnection from the power supply in accordance with the wiring rules.
- The oven must be earthed.
- Do not use adaptors, reducers or branching devices to connect the oven to the mains electricity supply, as they can cause overheating and burning.
- The appliance must not be installed behind a decorative door in order to avoid overheating.
- Please take extra care not to damage the lower trim of the oven during installation. The trim is important for correct air circulation and allows the door to open and close without obstruction. The manufacturer does not accept any responsibility for damage resulting from incorrect installation.

#### **Servicing**

- Do not repair or replace any part of the appliance unless specifically recommended in the user guide. All other servicing should be undertaken by a Fisher & Paykel trained and supported service technician or qualified person.

#### **Fire hazard**

- Do not use water on grease fires. Smother the fire or flame or use a dry chemical or foam type extinguisher.
- Use only dry oven mitts or potholders. Moist or damp potholders on hot surfaces could result in burns from steam. Do not let potholders touch hot areas or heating elements. Do not use a towel or a bulky cloth for a potholder. It could catch fire.
- Do not heat unopened food containers. They can build up pressure that may cause the container to burst and result in injury.

## SAFETY AND WARNINGS

---

### Food safety

- Leave food in the oven for as short a time as possible before and after cooking. This is to avoid contamination by organisms which may cause food poisoning. Take particular care during warm weather.

### General use

- This product has been designed for use in a domestic (residential) environment. This product is not designed for any commercial use. Any commercial use by the customer will affect this product's manufacturer's warranty.
- Household appliances are not intended to be played with by children.
- Children should not be left alone or unattended in the area where the appliance is in use. They should never be allowed to sit or stand on any part of the appliance.
- Children of less than 8 years old must be kept away from the appliance unless continuously supervised.
- This appliance can be used by children aged 8 years and above and persons with reduced physical, sensory or mental capabilities or lack of experience and knowledge if they have been given supervision or instruction concerning use of the appliance in a safe way and understand the hazards involved.
- Cleaning and user maintenance shall not be carried out by children without supervision.
- Do not store things children might want above the oven. Children could be burned or injured while climbing on the oven to retrieve items.
- Do not place heavy objects on the oven door.
- Always keep oven vents unobstructed. Do not wear loose fitting or hanging garments when using the appliance. They could ignite or melt if they touch an element or hot surface and you could be burned.
- Caution: Hot air can blow from the vent at the top of the oven as part of the oven's cooling system.
- Always position shelves in the desired location while the oven is cool (before preheating). If a shelf must be removed while the oven is hot, do not let the oven mitts or potholder contact hot heating elements in the oven or the base of the oven.
- Use only bakeware approved for ovens. Follow the bakeware manufacturer's guidance.
- Always place oven racks in desired location while oven is cool. If rack must be moved while oven is hot, do not let potholder contact hot heating element.
- Do not touch heating elements or interior surfaces of your oven. Heating elements and interior surfaces may be hot even though they are dark in color and could cause burns. The oven door, vent openings and surfaces near these openings may also become hot.
- This appliance is configurable to allow remote operation at any time. Do not store flammable materials or temperature sensitive items inside, on top or near the appliance.
- Neither the temperature sensor or aluminium foil must come in contact with the oven elements.
- Only use the temperature sensor recommended for this oven.
- The appliance must not be installed behind a decorative door in order to avoid overheating.
- **WARNING:** Accessible parts may become hot during use. Young children should be kept away.



## SAFETY AND WARNINGS

---

### Cleaning

- Do not clean the oven seal or use any oven-cleaning products on it. It is essential for a good seal, which ensures that the oven operates efficiently. Care should be taken not to rub, damage, move or remove the oven seal.
- Do not use oven cleaners, harsh/abrasive cleaning agents, waxes, or polishes. No commercial oven cleaner, oven liner, or protective coating of any kind should be used in or around any part of the oven.
- Do not use harsh/abrasive cleaners, scourers or sharp metal scrapers to clean the oven door glass since they scratch the surface, which may result in the glass shattering.
- Clean only the parts listed in this manual.
- Do not use a steam cleaner to clean any part of the oven.
- The door gasket is essential for a good seal. Care should be taken not to rub, damage or move the gasket.

### Self cleaning

- Spillages must be removed before starting a self-clean cycle.
- Before starting a self-clean cycle, remove oven shelves and all other cookware and/or utensils, and wipe up large food spills or grease deposits.
- Before starting a self-clean cycle, ensure you move any pet birds to another, closed and well-ventilated room. Some pet birds are extremely sensitive to the fumes given off during a self-clean cycle and may die if left in the same room as the oven during such a cycle.
- During a self-clean cycle, the oven reaches higher temperatures than it does for cooking. Under such conditions, the surfaces may get hotter than usual and children should be kept away.

### Light source information

- This product contains a light source of energy efficiency class G. The light source used in this appliance is not suitable for room illumination.

## BEFORE YOU BEGIN

- Your oven must be installed by a suitably qualified person according to the installation guide. The installer should complete the final installer checklist.
- Read this guide, taking special note of safety and warnings.
- Remove all internal and external packaging and recycle it responsibly where possible.
- Refit the shelves to your desired position in the oven.
- Condition the oven following guidance in first use.

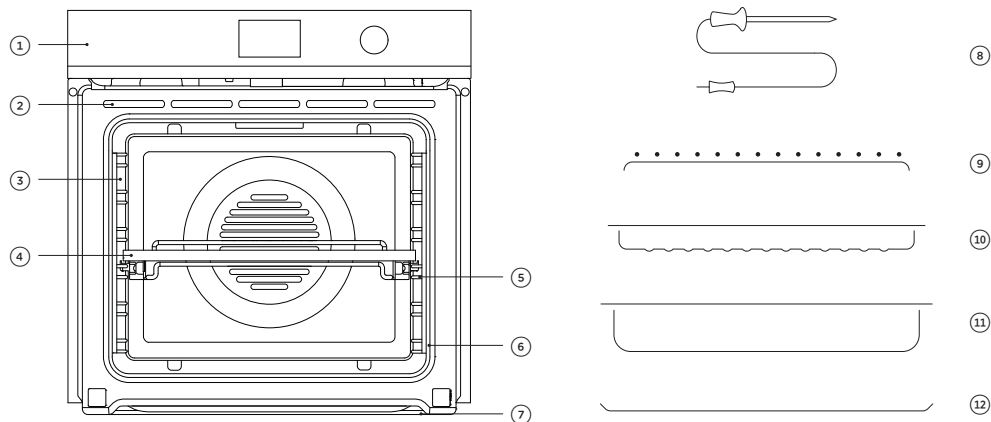

### Oven features and accessories

- |                 |                      |
|-----------------|----------------------|
| ① Oven controls | ⑦ Drip channel       |
| ② Oven vents    | ⑧ Temperature sensor |
| ③ Oven light    | ⑨ Grill rack         |
| ④ Shelves       | ⑩ Grid               |
| ⑤ Side racks    | ⑪ Roast dish         |
| ⑥ Oven seal     | ⑫ Baking tray        |

Not all accessories are provided with all models. To purchase additional accessories, go to [www.fisherpaykel.com](http://www.fisherpaykel.com)

## FIRST USE

---

### Oven racks

Your oven comes with the shelves positioned and secured inside. The following shows you how to remove and reposition them to your preferred position.

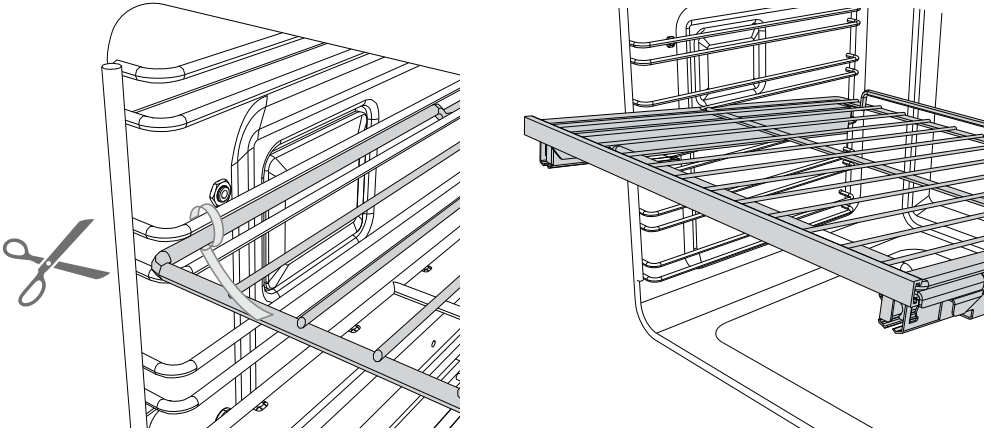

### Remove shelves from oven

- ① Remove all cable ties and packaging holding shelves in place.
- ② Remove all shelves, taking special care with sliding shelves.
- ③ To remove a sliding shelf, grip it at the front (making sure you are gripping the wire shelf and sliding frame together), lift upwards and pull it out of the oven.

For your safety, the wire shelves and sliding frames are built together as one unit and are not separable. When placed properly on the side racks, the slides prevent the wire shelves from tilting when pulled towards you.

# FIRST USE

## Replace shelving in your preferred positions

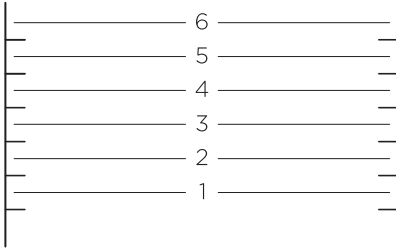

### Shelf positions

We recommend placing the sliding shelves on positions 2 and 4 for everyday cooking.

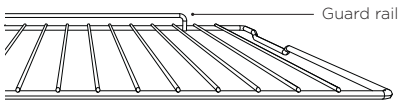

### To replace wire shelves

Check the shelf is positioned correctly, with the guard rail at the back, then slide into place on the side racks.

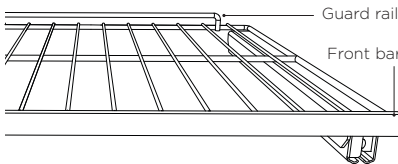

### To replace sliding shelves

- ① Grip the shelf at the front making sure you are holding the wire shelf and the sliding frame together.
- ② Make sure the shelf is level and facing the right way with the guard rail at the back.
- ③ Place the shelf on top of the side racks at the desired height, hooking the rear tags over the side racks on both sides.
- ④ Push the shelf all the way into the oven, making sure the front tags are also securely hooked over the side racks.

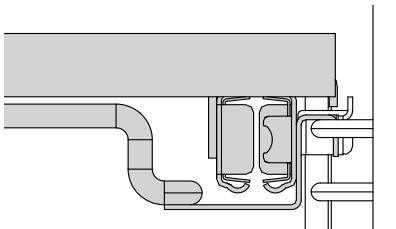

### Note

Ensure sliding shelves are positioned on top of the side rack wires instead of between them.

When there is food in the oven, take care to slide the shelves horizontally when extending them. This will prevent the tags lifting off the side racks and the shelf tipping over.

# FIRST USE

## Control panel

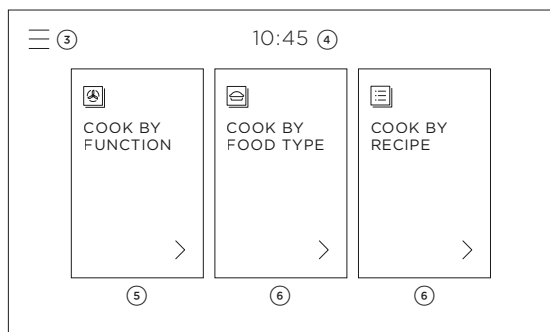
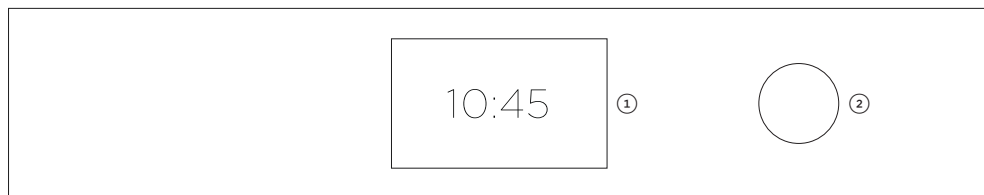

### Control panel features

- 1 Touchscreen display
- 2 Control dial
- 3 Menu
- 4 Clock
- 5 Oven functions
- 6 Guided cooking features

### Touchscreen display

Your oven is operated using an intuitive touchscreen display. Use the screen to navigate between functions, food types, recipes and settings.

### Using the touch controls

Use the ball of your finger, not its tip. The controls respond to touch, so pressure is not needed.

### Control dial

- Turn the control dial to scroll through menu items and set timers.
- Press in to select or press and hold to go back.

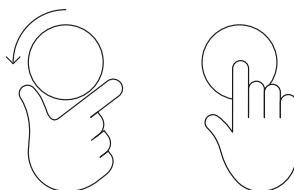
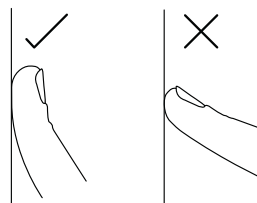

## FIRST USE

### Setting the clock

You'll need to set the time on your oven when it is first turned on, or after a power cut.

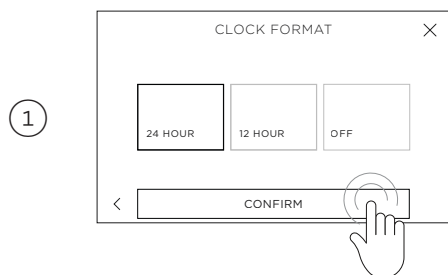

Choose between **24 HOUR**, **12 HOUR** or **OFF** then select **CONFIRM**.

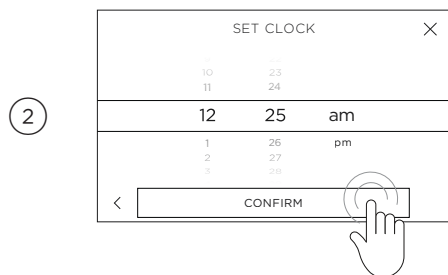

Scroll to set the correct time then select **CONFIRM**.

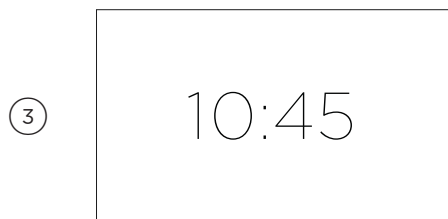

The time is now set and will show on the screen.

# FIRST USE

## Selecting and using a function

To select and use a function, touch the function name or icon. For more information on each function, touch the description underneath each function name.

### Selecting function

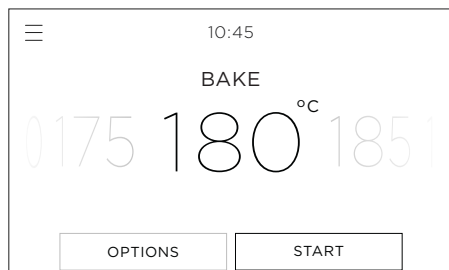
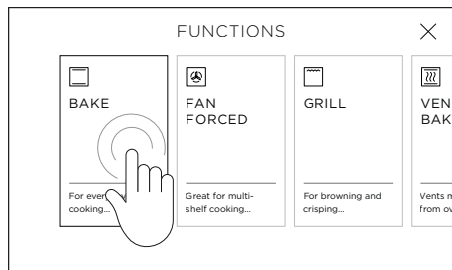

### Expanding a description

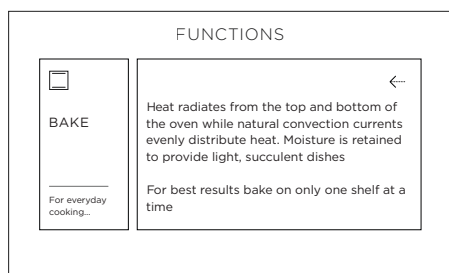
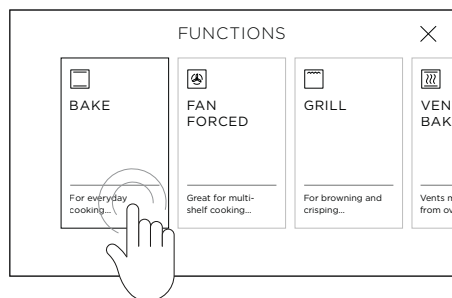

# FIRST USE

## Setting a function and temperature

For more information on the functions, touch the description underneath each function name or see the 'Cooking guide' section of this book.

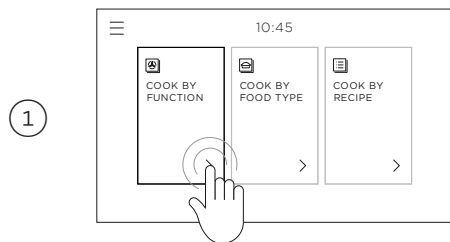

Touch the screen or turn the dial to enter the menu. Select **COOK BY FUNCTION**.

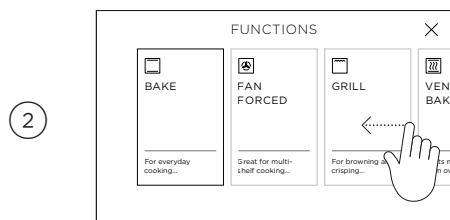

Scroll through the functions and select the one you want to cook with.



To adjust the preset temperature, swipe left or right or use the dial. Touch **START** to heat the oven and begin cooking.

A red bar will show on the screen while the oven is heating.

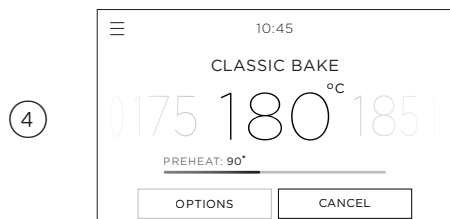

When the oven has reached the set temperature, a tone will sound, the bar will disappear and the dial will turn red.

Some functions do not need to preheat. For those functions the bar won't show and the dial halo will remain red throughout cooking.



# FIRST USE

## Editing or cancelling cooking

Touch the function name or temperature at any point during cooking to adjust.

### Changing the temperature

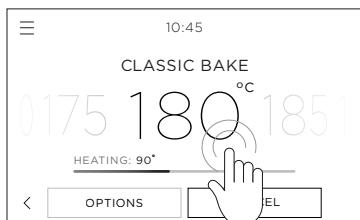

### Changing the function

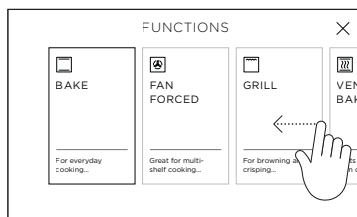
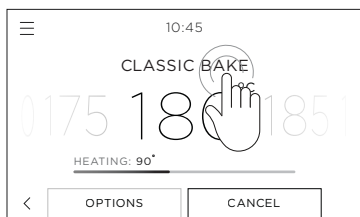

### Turning the oven off

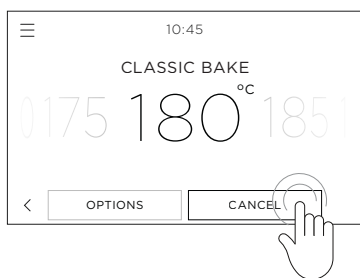

To stop cooking and turn the oven off, press **CANCEL** and then **CONFIRM** at any point.

### Rapid preheating stage

For some cooking functions, the oven will go through an initial rapid preheat stage. In this stage, the fan and both bake and grill elements will turn on to quickly heat the oven to the set temperature. Depending on the cooking function, the fan, bake and grill elements will turn off once the oven reaches the set temperature.

# FIRST USE

## Conditioning the oven

It is important to condition your oven before using it for cooking. This will burn off any manufacturing residues and ensure that you get the best results right from the start. It will take approximately 1 hour.

### Before you start:

Make sure you have removed all packaging and any cable ties used to secure the shelving during transit. Make sure all shelves are fitted in the oven. Make sure the kitchen is well ventilated during conditioning.

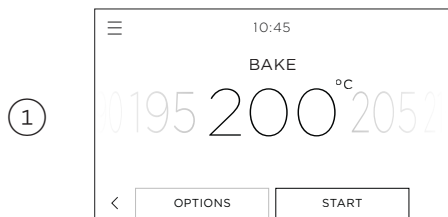

Select **COOK BY FUNCTION** and set the oven to **BAKE** at 200°C and heat for 30 minutes.

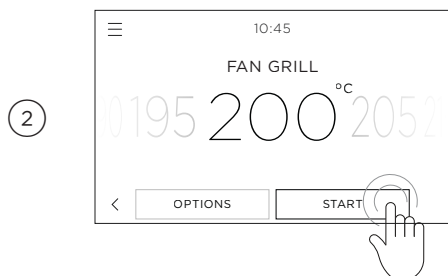

After 30 minutes change the function to **FAN GRILL** and heat for 5 minutes.

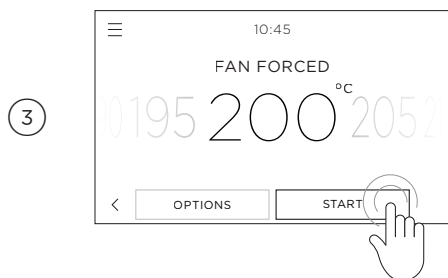

After 5 minutes, change the function to **FAN FORCED** and heat for a further 20 minutes. When you have finished, turn the oven off.

### After conditioning:

There will be a distinctive smell and a small amount of smoke during the conditioning process as manufacturing residue is burnt off. This is normal, but make sure the kitchen is well ventilated. Once cooled, wipe out the oven with a damp cloth and mild detergent, and dry thoroughly.

# USING THE OVEN LIGHT

## Turning the oven light ON or OFF

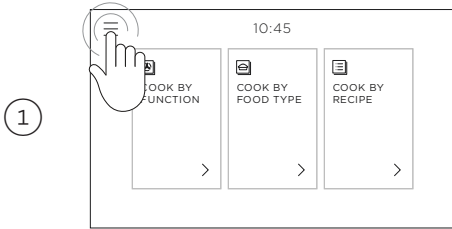

Touch the menu icon in the top left corner of the display.

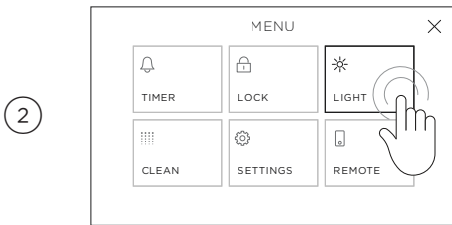

Select **LIGHT**.

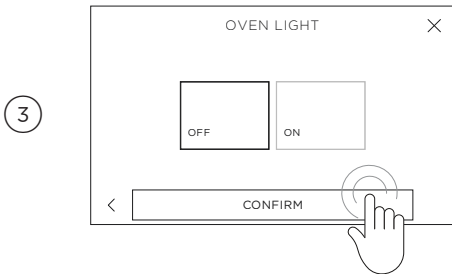

Select **ON** or **OFF** as required and then select **CONFIRM**.

## USING THE KITCHEN TIMER

- Use the kitchen timer to keep track of cooking times. You can use it at any time, even if you are not using the oven.
- The kitchen timer does not turn the oven off. See 'Cooking guide' 'Cooking Options' for how to set the **AUTO OFF** timer or **DELAYED COOK**.

### Setting the timer

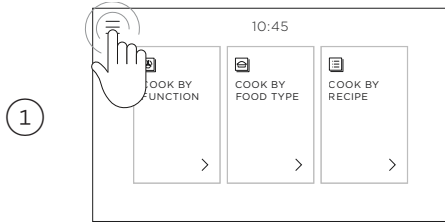

Touch the menu icon in the top left corner of the screen.

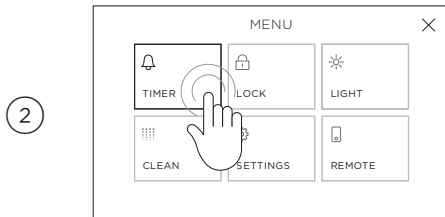

Select **TIMER**.

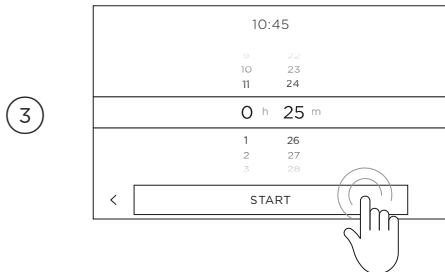

Scroll to set timer length then select **START**.  
You can set the timer for up to 11 hours 59 minutes.

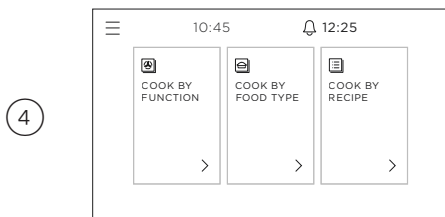

The timer countdown will show on the screen.

## USING THE KITCHEN TIMER

### Editing or cancelling the timer



Touch the timer countdown in the upper right of the screen.

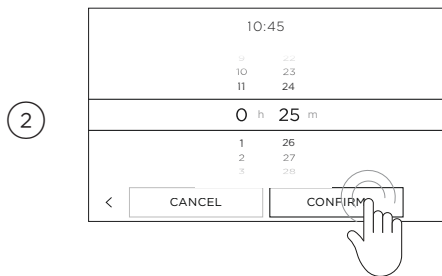

Adjust the timer as needed and select **CONFIRM**, or touch **CANCEL** to cancel the timer completely.

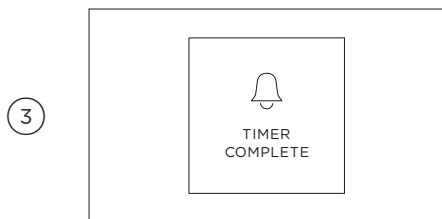

At the end of the timer a tone will sound every few seconds. Touch the screen anywhere to stop it.

## CHANGING THE TIME

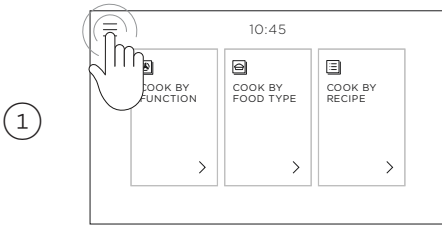

Touch the menu icon in the top left corner.

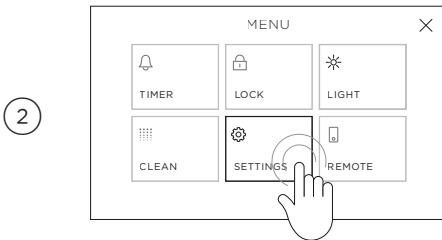

Select **SETTINGS**.

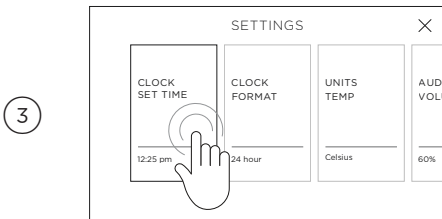

Select **CLOCK SET TIME**.

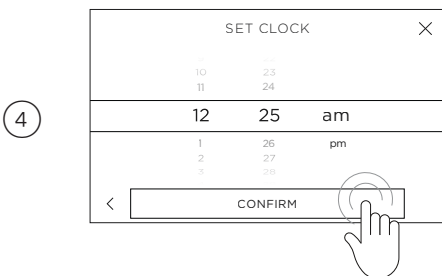

Scroll to change the time then select **CONFIRM**.

## LOCKING THE CONTROL PANEL

Lock the oven controls to prevent accidental use of the oven by children or when cleaning. When locked, the controls are unresponsive and the oven will not turn on.

For safety reasons you cannot lock the oven controls while the oven is in use or if automatic cooking options have been set.

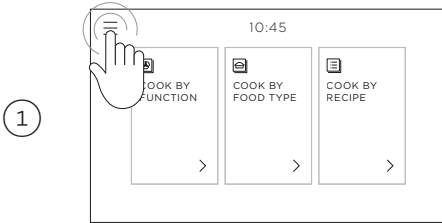

Touch the menu icon in the top left corner of the screen.

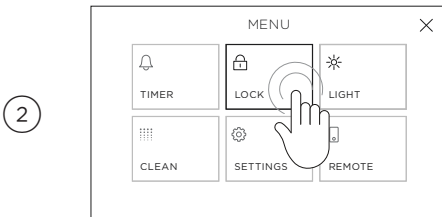

Select **LOCK**.

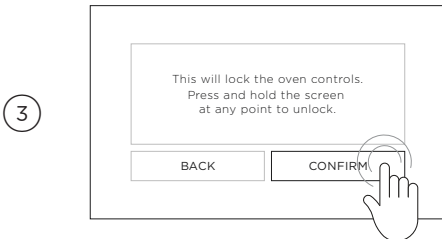

Select **CONFIRM**.

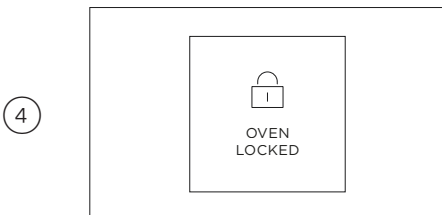

The control panel is now locked. The controls will remain unresponsive until it is unlocked.

## UNLOCKING THE CONTROL PANEL

---

1

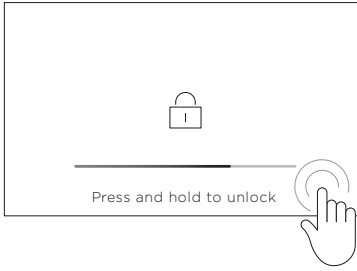

Press and hold anywhere on the screen until the bar fills and the oven unlocks.



# COOKING OPTIONS

Your oven comes with a number of automatic cooking options to help you get the best results:



## DELAYED COOK

Set the oven to turn on later in the day, cook for a set length of time and turn off automatically.



## AUTO OFF

Set the oven to turn off after a set length of time.



## TEMPERATURE SENSOR

Use the temperature sensor to automatically turn your oven off when your food reaches a set internal temperature.

You can set these options either before you start cooking, or at any point once your oven is already running.

1

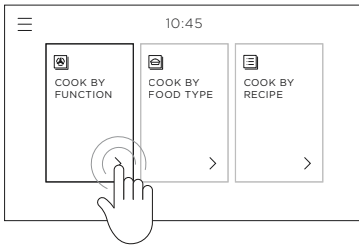

Select **COOK BY FUNCTION**.

2

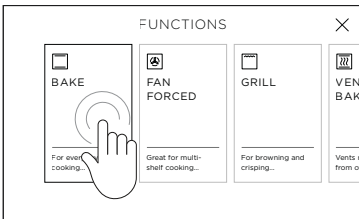

Select the function you want to cook with.

3



Touch **OPTIONS** at the bottom of the screen and select the option you want to use.

## DELAYED COOK

The grill element may come on while the oven is heating up. Position food on a lower shelf or cover to prevent burning as the oven heats up.

Safe food handling: leave food in the oven for as short a time as possible before and after cooking or defrosting, to avoid contamination by organisms which may cause food poisoning. Take particular care during warmer weather.

When using **DELAYED COOK** we do not recommend using **GRILL**, **FAN GRILL** or **AIR FRY** functions.

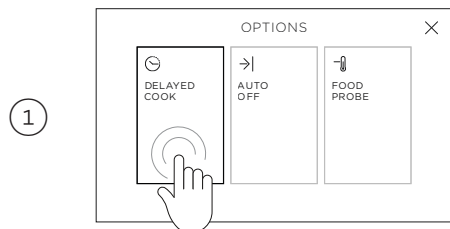

Select **DELAYED COOK** from the **OPTIONS** menu.

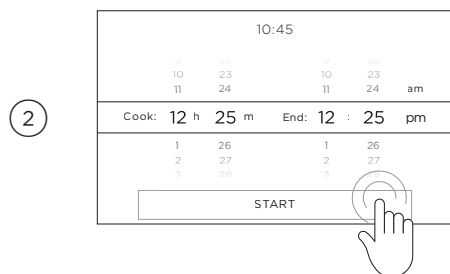

Scroll to set a cook duration and an end time, then select **START**.

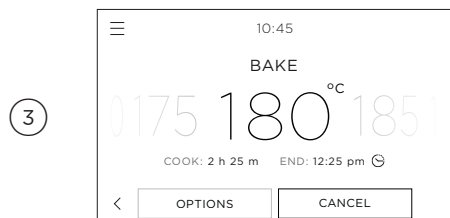

**DELAYED COOK** is now set.

Your oven will automatically calculate when it needs to turn on based on what cook duration and end times are set.



**To edit or cancel**

Touch **OPTIONS** and select **DELAYED COOK** at any point to edit or cancel.

**When the end time is reached**

The oven will automatically turn off and a tone will sound.

## AUTO OFF

1

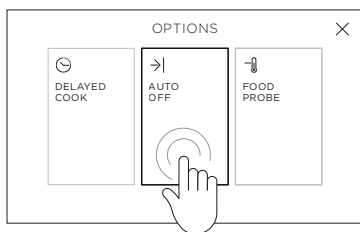

Select **AUTO OFF** from the **OPTIONS** menu.

2

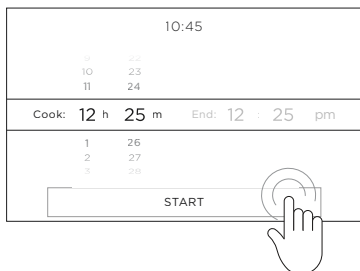

Scroll to set a cook duration and select **START**. Your oven will automatically calculate the end time based on what cook duration is set.

3

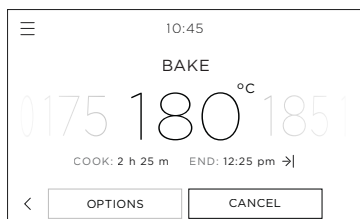

**AUTO OFF** is now set.

Your oven will cook for the set length of time and then turn off automatically.

4



**To edit or cancel**

Touch **OPTIONS** and select **AUTO OFF** at any point to edit or cancel.

**When the end time is reached**

The oven will automatically turn off and a tone will sound.

## TEMPERATURE SENSOR

---

### Tips for using the temperature sensor

- You can still use the kitchen timer when the sensor is in use.
- You cannot use the temperature sensor with **DELAYED COOK** or **AUTO OFF**.
- The internal temperature of meat will continue to rise by a few degrees after you have removed it from the oven, so allow for this in your calculations. After cooking, cover and let the meat rest for 15 to 20 minutes.
- If you wish to remove food from the oven (eg basting), unplug the temperature sensor from the oven but do not remove it from the meat. When you are ready to resume cooking, ensure you plug the sensor plug back into the oven.
- When cooking meat, insert the sensor horizontally into the centre of the thickest part. The thicker the meat, the longer it will take to cook, so it is important that the tip of the sensor is measuring the temperature of the meat at its thickest point. Make sure the tip of the sensor is not protruding out of the meat, and does not touch bone, fat or gristle, as these will heat up more quickly than the lean meat.

### Internal temperatures and food safety

- Ensure meat is fully defrosted before cooking. The temperatures given onscreen and in the Cooking Guides are recommendations. Results will depend on the quality and composition of the food.
- Rest meat after cooking to allow the internal temperature to continue to rise.
- For food safety, high risk foods such as fish should reach a minimum internal temperature of 63 - 70°C and poultry and minced meat should reach 75°C.

# TEMPERATURE SENSOR

## Using the temperature sensor

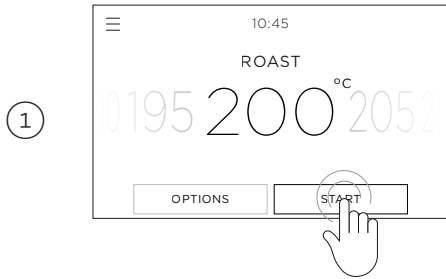

Select your function and temperature and preheat the oven if needed.

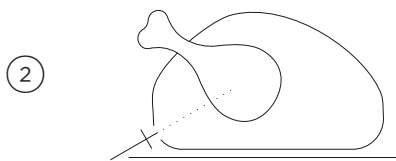

Insert the sensor into your food.

Always position the tip of the sensor in the thickest part of the dish, avoiding fat and bone in meat.

Ensure the tip of the sensor doesn't protrude out the other side of food or touch cookware.

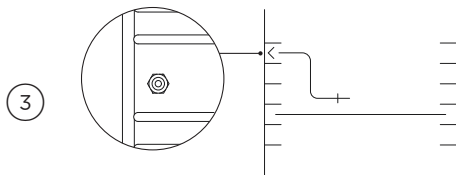

Place food in the oven and plug the sensor into the socket inside the oven, on the left hand side.

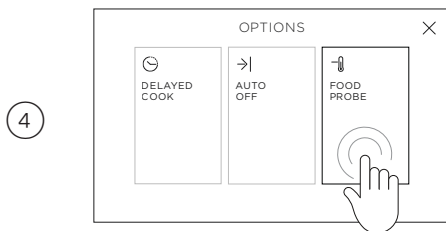

Go to the **OPTIONS** menu and select **TEMPERATURE SENSOR**.

## TEMPERATURE SENSOR

5

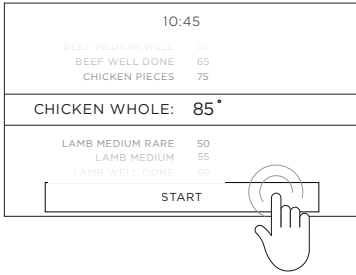

Scroll to select a food type and adjust the temperature if desired. Select **START** to begin.

6

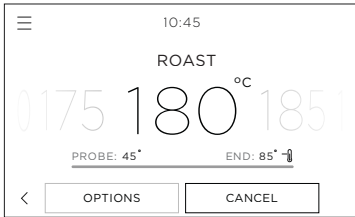

**TEMPERATURE SENSOR** is now set.

Your oven will cook until the set temperature is reached and then turn off automatically.

7

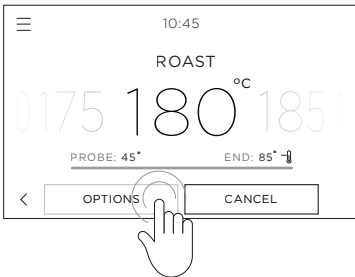

**To edit or cancel**

Touch **OPTIONS** and select **TEMPERATURE SENSOR** at any point to edit or cancel.

**When the end time is reached**

The oven will automatically turn off and a tone will sound.

## GUIDED COOKING

Your oven comes with guided cooking features that help you choose the optimal oven settings, accessories and methods to get the best results:



### COOK BY FOOD TYPE

Optimum oven settings, shelf positions, cookware and accessories for cooking a particular type of food or cut of meat.



### COOK BY RECIPE

A collection of recipes that have been specifically designed for and tested in this style of oven.

### Using COOK BY FOOD TYPE

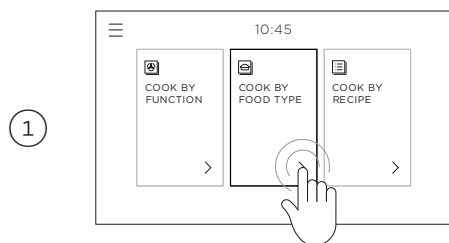

From the home screen, select **COOK BY FOOD TYPE**.

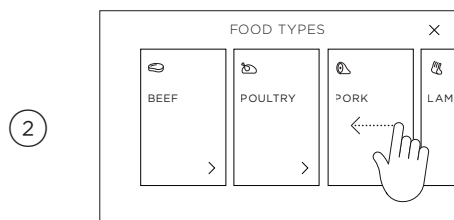

Swipe through the various food types and select the type of food you want to cook. For more information touch the description underneath each food type.

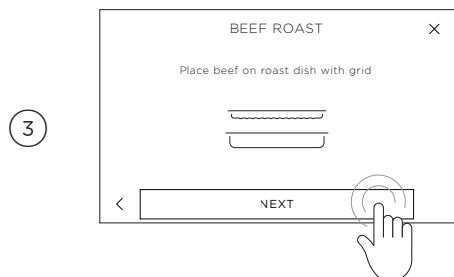

Follow the instructions onscreen for what accessories and cookware to use and how to set up your oven.

# GUIDED COOKING

## Using COOK BY RECIPE

1

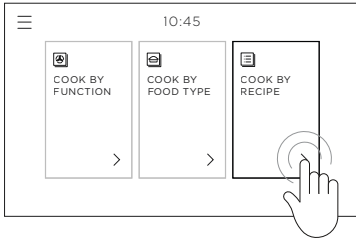

Select COOK BY RECIPE.

2

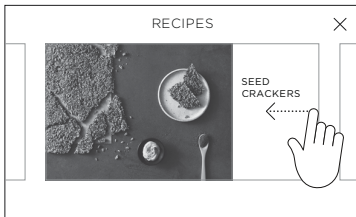

Scroll to look through the recipe collection and select your favourite.  
Follow the on-screen guidance.



## COOKING GUIDE

### General guidelines

This oven has been designed to utilise its four elements and rear fan in different combinations for enhanced performance. The wide range of functions allows you to cook all food types to perfection.

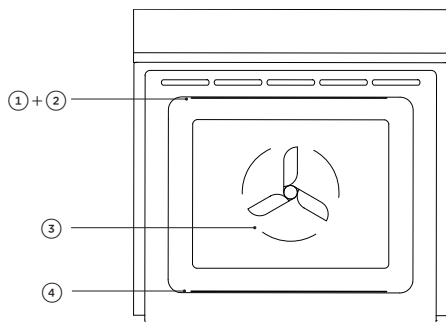

### Oven elements

- ① upper outer element
- ② upper inner element
- ③ rear element (concealed)
- ④ lower element (concealed)

## IMPORTANT!

Use all the functions with the oven door closed.

### Baking

- For best results when baking, always pre-heat your oven. The screen will show a red progress bar while the oven is heating up.
- **Single shelf cooking:** place your baking on a shelf that will position the top of your pan near the centre of the oven.
- **Multi shelf cooking:** Always leave a space between shelves to allow the air to circulate.

### Grilling

- Always grill with the oven door completely shut.
- Always keep a close watch on your food to avoid charring or burning.
- If you use glass or ceramic pans, be sure they can withstand high oven temperatures.
- For thinner cuts of meat, or for toasting or browning foods, use a higher shelf position.
- Thicker cuts of meats should be grilled on lower shelves or at a lower grill setting to ensure even cooking.

### Roasting

- The **ROAST** function is designed to brown the outside of the meat, but still keep the inside moist and juicy.
- Boneless, rolled or stuffed roasts require longer than roasts containing bones. Poultry should be well cooked with the juices running clear and a minimum internal temperature of 75°C.
- Always roast meat fat side up.
- If using a roasting bag or a covered roast dish, do not use the **ROAST** function.

# COOKING GUIDE

## Reheating

- **Never reheat food more than once.**
- Use Vent Bake to reheat food, or follow the instructions in **COOK BY FOOD TYPE**.
- Always reheat food to piping hot, or to a minimum internal temperature of 85°C. This reduces the risk of contamination.
- Reheat food in a dish with a lid or cover tightly with foil.
- Once hot, use the **WARM** function to keep the food warm.

## Dehydrating

- Use the **DEHYDRATE** function to preserve food and create healthy snacks.
- For best results, use the roast dish with grill rack insert. Ensure food is laid flat and is not overlapping. If dehydrating meat, turn it over halfway through to ensure even drying.
- Store dehydrated food in an airtight container after it's completely cooled.

## Dough proofing

- Use the **RAPID PROOF** function to proof dough for breadmaking and pizza.
- Place dough in a lightly oiled bowl and cover with plastic wrap or a clean, damp cloth.
- Position in the centre of the oven.
- To prevent overproofing check the dough every 30 minutes.

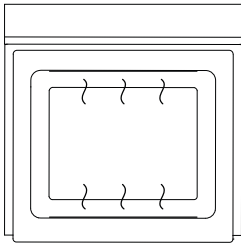

### BAKE

upper outer and lower elements

#### Ideal for:

foods that require a longer cooking time eg rich fruit cake, brownies, or bread in combination with **VENT BAKE**.

This function will **PREHEAT** for around 8 minutes to 180°C.

- Retains moisture.
- Ideal for cakes and foods that require baking for a long time or at low temperatures.
- This function is not suitable for multi-shelf cooking.

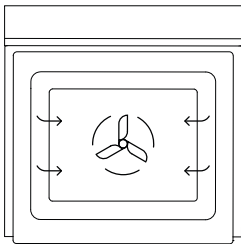

### FAN FORCED

fan plus rear element

#### Ideal for:

multi-shelf cooking, eg biscuits, cookies, scones, muffins and cupcakes.

This function will **PREHEAT** for around 8 minutes to 180°C.

- Hot air is blown into the cavity, providing a consistent temperature at all levels.
- Always leave a gap between shelves to allow air to move freely. This ensures food on the lower tray can still brown.
- If converting a recipe from **BAKE** to **FAN FORCED**, we recommend that you decrease either the bake time and/or the temperature by approximately 20°C, especially for items with longer bake times.

## COOKING GUIDE

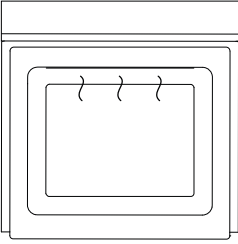

### **GRILL** upper inner and outer elements

#### **Ideal for:**

toasting bread or for top-browning to finish off dishes.

- Intense radiant heat is delivered from both top elements.
- There are 9 steps between **LO** and **HI** (100% power).
- For best results allow oven to heat for 5 minutes before grilling.
- The dial halo will remain red while using the grill function.

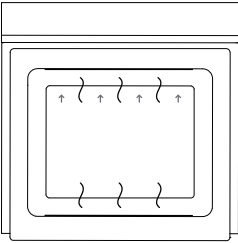

### **VENT BAKE** upper outer and lower elements plus venting

#### **Ideal for:**

meringues, yorkshire pudding, and finishing off choux pastry, croissants and bread.

This function will **PREHEAT** for around 8 minutes to 180°C.

- Venting removes excess moisture, reducing both steam and condensation in the oven.
- Gently browns without drying.

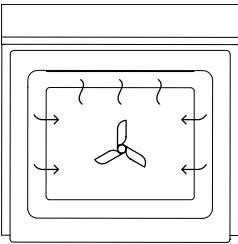

### **FAN GRILL** fan plus upper outer and inner elements

#### **Ideal for:**

whole chicken, beef tenderloin or grilling fish or steak.

- Uses the intense heat from the elements for top-browning and the fan to ensure even cooking of foods.
- Meat, poultry and vegetables cook beautifully; food is crisp and brown on the outside while the inside remains moist and tender.

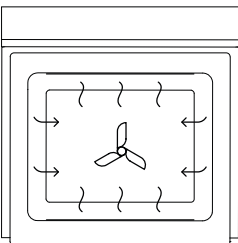

### **FAN BAKE** fan plus upper outer and lower elements

#### **Ideal for:**

single shelf baking that requires less than an hour to cook. Foods such as muffins, biscuits and cupcakes.

This function will **PREHEAT** for around 8 minutes to 180°C.

- The oven fan circulates hot air from the top outer and the lower elements and distributes it around the oven cavity.
- Food cooked tends to brown quickly.

## COOKING GUIDE

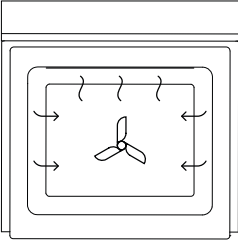

### ROAST

fan plus upper and lower elements

#### Ideal for:

roasting meat and vegetables.

#### This is a two-step program.

- **Searing:**

an initial 20-minute stage that crisps and browns the roast, and caramelises the outside of the meat.

- **Cooking at preset temperature:**

after searing, the temperature will decrease to your preset level for the remainder of the cook time, producing a tender and juicy roast.

- The oven does not need preheating.
- If desired, use the grill rack or grid, or place vegetables under the roast to allow the juices to drain away from your meat. This will allow the hot air to circulate under the meat as well.

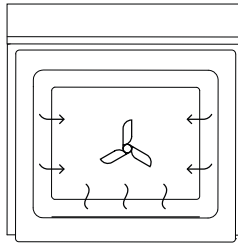
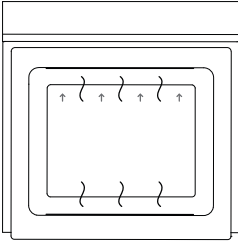

### PIZZA BAKE

fan plus lower element

#### Ideal for:

crisp-based pizzas.

This function will **PREHEAT** for around 8 minutes to 180°C.

- The fan circulates heat from the lower element throughout the entire oven.
- Excellent for cooking pizza as it crisps the base beautifully without overcooking the topping.
- For best results, pre-heat a pizza stone for at least 1 hour and bake on oven shelf position 1 or 2.

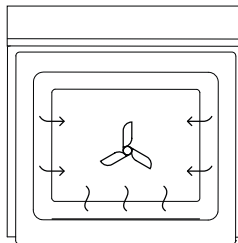

### PASTRY BAKE

fan plus lower element

#### Ideal for:

sweet and savoury pastry foods and delicate foods that require a crisp base and some top-browning, eg frittata, quiche.

This function will **PREHEAT** for around 8 minutes to 180°C.

- The fan circulates heat from the lower element throughout the oven.
- Provides intense heat to the base of foods and allows gentle top-browning.

## COOKING GUIDE

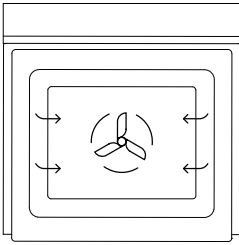

### **SLOW COOK** fan plus rear element

#### **Ideal for:**

slow-cooked dishes such as casseroles, stews and braises.

- The fan circulates heat from the rear element to gently cook food.
- This function has low energy consumption

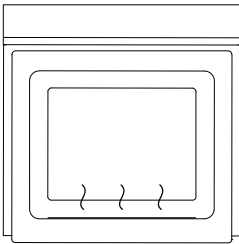

### **CLASSIC BAKE** lower element

#### **Ideal for:**

dishes that require delicate baking and have a pastry base, like custard tarts, pies, quiches and cheesecake.

This function will **PREHEAT** for around 8 minutes to 180°C.

- Heat comes from the lower element only.
- This is the traditional baking function, suitable for recipes that were developed in conventional ovens.
- Bake using only one shelf at a time.

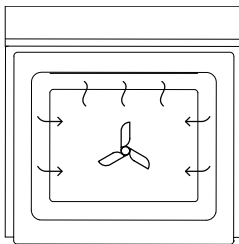

### **AIR FRY** fan plus upper outer and inner elements

#### **Ideal for:**

food cooked from frozen, or battered and crumbed food that would usually be deep fried.

- Replicates the conditions used in an air fryer.
- A healthier way of frying which crisps food while using less oil. For best results, coat food with 1–2 tablespoons of oil.
- For pre-packaged food: if the manufacturer's cooking advice suggests using a function that isn't fan-based, decrease temperature by 20°C (70°F).
- **Single shelf cooking:** cook in the upper part of the oven, but not at the highest shelf position.

## COOKING GUIDE

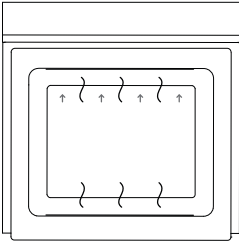

### RAPID PROOF

upper outer and lower elements plus venting

#### Ideal for:

providing the optimum warm and draft-free environment for proving yeast dough.

- Gentle heat is generated from the upper and lower elements.
- This method provides a faster proof time than at room temperature.
- For best results, cover dough to prevent surface drying.

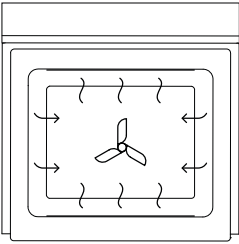

### DEHYDRATE

fan plus rear element

#### Ideal for:

drying meat, fruit, vegetables and herbs, such as beef jerky and fruit leather.

- Gently circulates air, providing a consistent low heat for dehydrating and drying food.

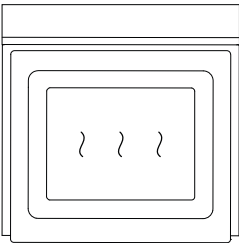

### WARM

upper outer and lower elements plus venting

#### Ideal for:

keeping cooked food hot, or to warm plates and serving dishes.

- Provides a constant low heat of less than 90°C.
- To reheat food from cold, use another function or **COOK BY FOOD TYPE** to heat the food piping hot, then change to **WARM**, as this function alone will not bring cold food up to a high enough temperature to kill any harmful bacteria.

## USER PREFERENCE SETTINGS

---

The settings menu allows you to adjust your user preferences to:

- change the time
- change the clock format (12 hours, 24 hours or off)
- display the temperature in degrees celsius or fahrenheit
- adjust the volume of audio feedback
- turn timer alarms on or off
- turn audio tones on or off
- operate in Sabbath Mode
- change the language of the display
- adjust the brightness of the display
- manage dial settings:
  - change the dial scroll direction
- restore all settings to factory original.

### **IMPORTANT!**

- You cannot change the settings when your oven is cooking or has any automatic cooking options set.
- Tones and alarms will still sound for faults if audio settings are turned off.

# USER PREFERENCE SETTINGS

## Changing the settings

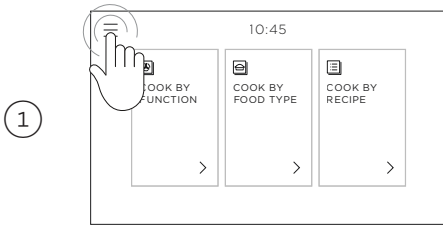

Touch the menu icon in the top left corner of the screen.

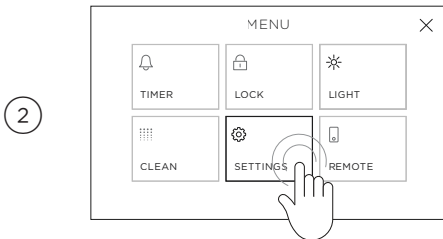

Select **SETTINGS**.

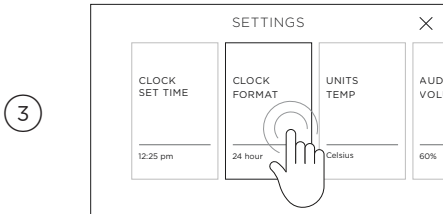

Select the setting you want to change, adjust as needed then select **CONFIRM**.



# SABBATH MODE

This setting is designed for religious faiths that observe a 'no work' requirement on the Sabbath.

While your oven is in Sabbath Mode it will not have the usual accurate temperature control:

HEAT LEVEL	APPROXIMATE TEMP (°C)	APPLICATION
Low	75 - 100	Keep hot food warm
Moderate	155 - 180	Reheat cooked food from cold
High	185 - 210	Cooking raw food

## While your oven is in Sabbath Mode:

- the oven will not react to user actions
- lights, fans and display will not respond to the door opening
- if the door is open for too long, this may result in loss of temperature
- no tones or alarms will sound and alert codes or temperature changes will not be displayed
- the oven light can be set to remain either on or off
- the oven will remain in Sabbath Mode until cancelled
- **CLASSIC BAKE** is the only function available
- to maintain cavity temperature minimise the number of door openings

## Setting Sabbath Mode

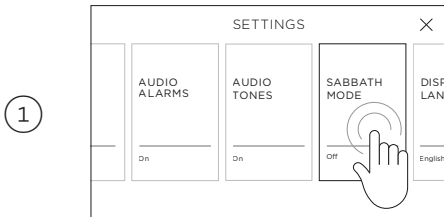

In the settings menu select **SABBATH MODE** and follow the instructions on the screen.

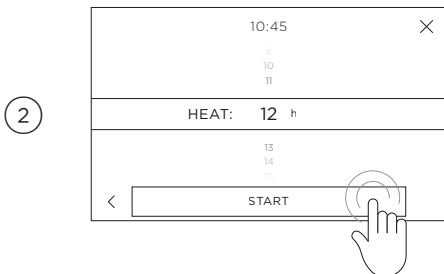

Set your desired heating level and select whether you want the oven light **ON** or **OFF** during cooking.

Scroll to set your desired cook time and then select **START**. You can set the oven to heat for up to 74 hours.

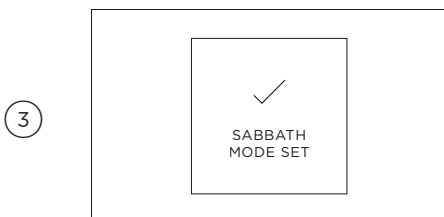

## Sabbath Mode is now set.

The oven will heat for the set length of time and then turn off.

The oven will remain in Sabbath Mode until it is cancelled.

# SABBATH MODE

---

## Cancelling Sabbath Mode

1

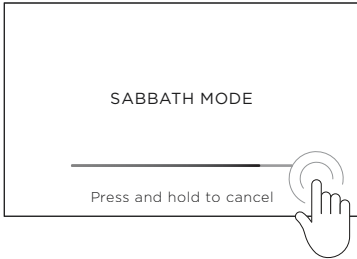

Touch and hold the screen until the bar fills.

2



**SABBATH MODE CANCELLED** will appear and you can now use your oven normally.

## CARE AND CLEANING

### Manual cleaning

#### ALWAYS

- Before any manual cleaning or maintenance, first wait for the oven to cool down to a safe temperature to touch, then turn its power supply off at the wall.
- Read these cleaning instructions and the 'Safety and warnings' section before you start cleaning your oven.
- To prevent soiling from becoming 'baked on' and stubborn, we recommend removing any easy-to-reach spills, food or grease stains from the oven cavity enamel after each use.
- Always clean the inner glass pane before starting Self Clean. Failure to do this will mean that residue will bake on and be impossible to remove.
- Always remove oven shelves before starting Self Clean.

#### NEVER

- Never use a steam cleaner.
- Never store flammable substances in the oven.
- Never use abrasive or harsh cleaners, cloths, scouring pads or steel wool. Some nylon scourers may also scratch. Check the label first.
- Never use oven cleaner on catalytic panels or in a pyrolytic oven.
- Never leave alkaline (salty spills) or acidic substances (such as lemon juice or vinegar) on the oven surfaces.
- Never use cleaning products with a chlorine or acidic base.

WHAT?	HOW?	IMPORTANT!
<b>Control Panel</b>	Take particular care when cleaning the control panel glass and screen. Only use a damp cloth with detergent.	Do not use any oven cleaners, harsh or abrasive cleaners, scouring pads, steel wool or sharp metal scrapers on the glass. These may scratch and damage the surface.
<b>Dial</b>	Clean with a solution of mild detergent and hot water, then wipe dry.	Do not use stainless steel or oven cleaner on the dial, as doing so may damage its coating.
<b>Stainless steel strip/oven door handle*</b>	Clean with a solution of mild detergent and hot water, then wipe dry with a microfibre cloth. If necessary, use a suitable stainless steel cleaner and polish.	Always read the label to make sure that your stainless steel cleaner does not contain chlorine compounds as these are corrosive and may damage the appearance of your oven. Always rub the stainless steel in the direction of the grain.
<b>Oven door frame and plastic corner clips</b>	Clean with a solution of mild detergent and hot water, then wipe dry.	

\*some models only

## CARE AND CLEANING

WHAT?	HOW?	IMPORTANT!
Oven cavity	<p>To clean light soiling off the enamelled surfaces: Wipe with a damp cloth and a solution of hot water and mild detergent or an ammonia-based cleaner.</p> <ul style="list-style-type: none"> <li>Wipe dry with a soft cloth.</li> </ul> <p>To clean stubborn, 'baked on' soiling or the whole oven cavity: use Self Clean. See 'Using Self Clean' for guidance.</p>	<ul style="list-style-type: none"> <li>To prevent soiling from becoming 'baked on' and stubborn, we recommend removing any easy-to-reach spills, food or grease stains from the enamelled surfaces after each use. Doing so will reduce the need for using Self Clean frequently.</li> <li>To make wiping out the oven easier you may remove the oven door. See the following pages for more information.</li> </ul>
Temperature sensor	Clean with a solution of mild detergent and hot water, then wipe dry with a microfiber cloth.	<ul style="list-style-type: none"> <li>Clean after every use to avoid contamination.</li> <li>Do not wash in the dishwasher, immerse in soapy water, use oven cleaner or leave in the oven during a Self-clean cycle.</li> </ul>
Full extension sliding shelf	Wipe with a damp cloth and mild detergent. Do not wipe off or wash away the white lubricating grease (visible when the shelf is extended).	Never leave this shelf in the oven during a Self-clean cycle. Do not wash the shelf in the dishwasher, immerse in soapy water, or use oven cleaner on it. Doing so will prevent the slides from running smoothly.
Grid Grill rack Grill pan Wire oven shelves	Clean with a solution of mild detergent and hot water. Pre-soak stubborn burnt-on stains in a solution of dishwasher powder and hot water. These parts are also dishwasher safe.	Never leave any of these parts in the oven during a Self-clean cycle (except for the side racks). They will become discolored or damaged.
Oven seal	Do not clean this part.	
Oven door glass (after every use)	<p>Use a soft cloth and a mixture of warm water and dishwashing liquid to remove soiling after every use.</p> <p>For stubborn stains, try a mixture of baking soda and warm water with a non-abrasive scrubbing pad, then wipe dry with a soft, lint-free cloth.</p>	Do not use oven cleaners or any other harsh/abrasive cleaners, cloths, scouring pads, steel wool or sharp metal scrapers to clean the oven door glass. These scratch the glass, which in turn could result in the glass cracking and shattering. Do not allow grease to build up on the glass or become baked on as this reduces visibility into the oven.

## CARE AND CLEANING

### Removing the side racks

Remove the side racks to make cleaning the oven easier. The side racks can be left in the oven during Self Clean.

### IMPORTANT!

**Always turn the oven off at the wall first. Ensure the oven has cooled down completely before starting.**

1

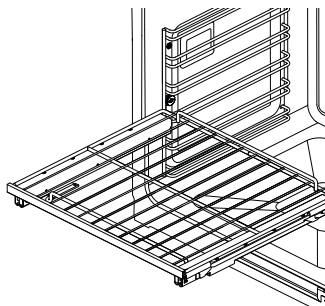

Slide out all shelves and remove.

2

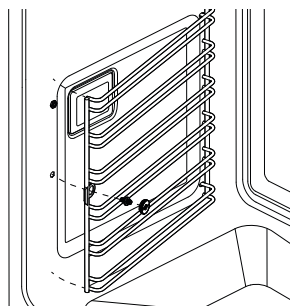

Unscrew and remove the fixing nut at the front of the side rack. Use a coin to loosen the nut if necessary.

Pull the front of the rack toward the back of the oven until the front tab is clear of the fixing nut.

3

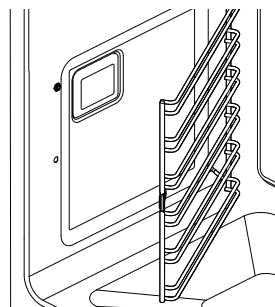

Slide the side rack forward until the rear prongs are clear of the holes.

## CARE AND CLEANING

### Refitting the side racks

Remove the side racks to make cleaning the oven easier. The side racks can be left in the oven during Self Clean.

### IMPORTANT!

**Always turn the oven off at the wall first. Ensure the oven has cooled down completely before starting.**

1

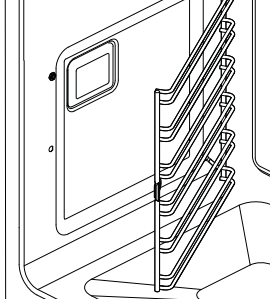

Slide the rear prongs of the side rack back into the holes, ensuring the rack is firmly pushed up against the side wall of the oven.

2

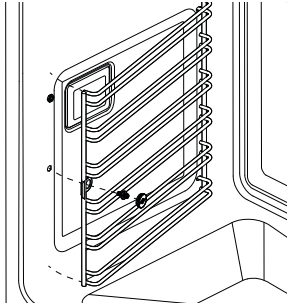

Fit the side rack front tab over the fixing screw.

Replace the fixing nut. You may use a coin to tighten the nut.

## CARE AND CLEANING

---

### Replacing the oven light bulbs

- Your oven uses G9 halogen bulbs with the specifications 220–240V, 50Hz and 25W.
- Always hold the replacement bulb in a soft cloth. Touching the bulb will reduce its life-span.
- The two oven lights are located behind the opaque glass panels on each side wall of your oven (one on each side).
- Note: Oven bulb replacement is not covered by your warranty.

### Changing the bulb

- ① Let the oven cavity and grill element cool down before changing the bulb. Before switching off the oven, take note of which light(s) are not working.

## IMPORTANT!

### Turn the oven off at the wall before continuing.

- ② Remove the oven shelves and side racks (see 'Care and cleaning').
- ③ Pull the glass cover off (if you find this difficult, you can gently prise the cover off using the handle of a spoon or similar in the notches between the glass panel and oven wall while holding the cover to ensure it does not fall).
- ④ Pull out the faulty bulb.
- ⑤ Holding the replacement bulb in a soft cloth or tissue insert it into the socket.
- ⑥ Replace the glass cover pushing it firmly into place.

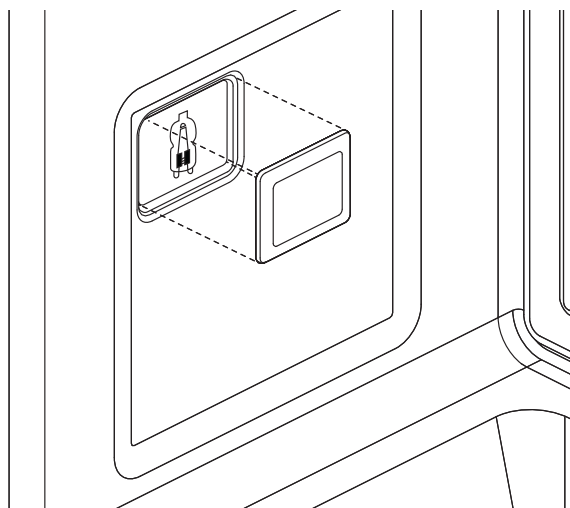

## CARE AND CLEANING

---

### Removing and refitting the oven door.

#### **IMPORTANT!**

Take care, the oven door is heavy.

To remove the door

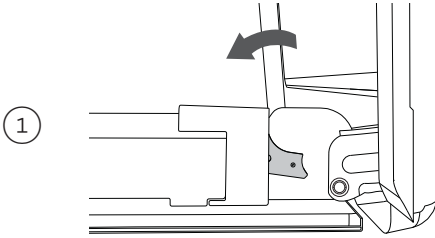

Open the door fully.

Locate the two small metal locking levers on both door hinges either side.

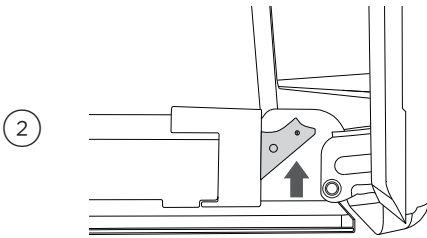

Push each locking lever up fully to release the door from the hinge.

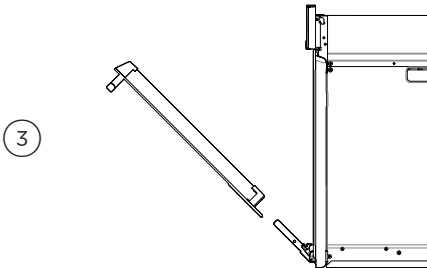

Holding the door on both sides, lift door back up to 45° and carefully pull the door out and away from the hinges.



## CARE AND CLEANING

---

### To refit the door

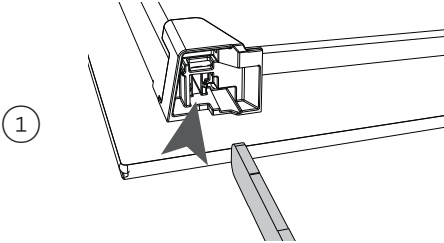

Holding the door on both sides, line up the holes in the base of the door with the hinges and slide the door on.

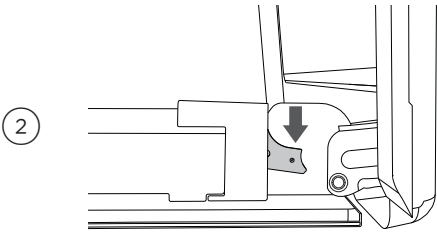

Ensure the door is firmly in place on the hinges. Open the door fully again and push each locking lever down to lock the door onto the hinge.

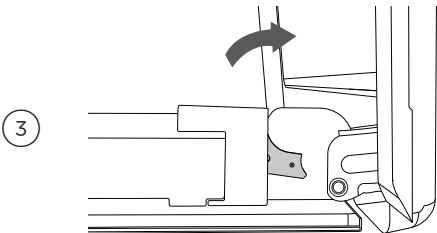

**IMPORTANT!**  
Ensure the levers are both fully locked before trying to shut the door.

## CARE AND CLEANING

---

### Removing the door glass panes for cleaning

The oven door is made up of 3 glass panes. To clean the middle pane you will first need to remove door and inner pane.

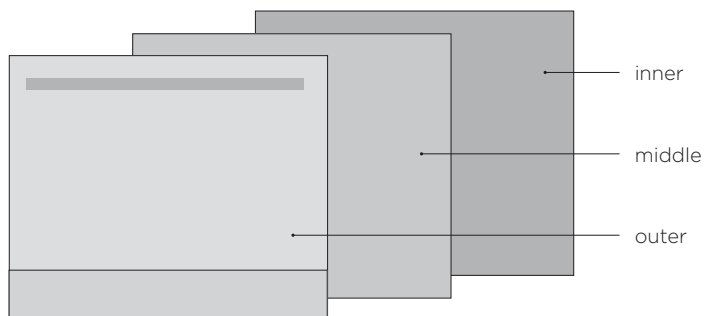

### IMPORTANT!

- Make sure you follow the precautions and instructions below very carefully. Replacing the glass panes and the door incorrectly may result in damage to the oven and could void your warranty.
- Take care, the oven door is heavy. If you have any doubts, do not attempt to remove the door.
- Make sure the oven and all its parts have cooled down. Do not attempt to handle the parts of a hot oven.
- Take extreme care when handling the glass panes. Avoid the corners and edges of the glass bumping against any surface. This may result in the glass shattering.
- Don't use oven cleaners or any other harsh/abrasive cleaners, cloths, scouring pads, steel wool or sharp metal scrapers to clean the glass surfaces. These scratch the glass and may damage its special coating, which in turn could result in the glass cracking or shattering.
- If you notice any sign of damage on any of the glass panes (such as chipping or cracks), do not use the oven. Contact a Fisher & Paykel trained and supported service technician or Customer Care.
- Ensure you replace all the glass panes correctly. Do not use the oven without all glass panes correctly in place.
- If the glass panes feel difficult to remove or replace, do not force them. Contact a Fisher & Paykel trained and supported service technician or Customer Care.

Note: service visits providing assistance with using or maintaining the oven are not covered by your warranty.

We recommend removing the door to make cleaning the glass easier. See 'Removing and refitting the oven door' for instructions. Once the door is removed, lay it down on a soft, clean, flat surface.

Make sure you follow the precautions and instructions below very carefully. Replacing the glass panes and the door incorrectly may result in damage to the oven and may void your warranty.

## CARE AND CLEANING

---

### To remove the inner pane

1

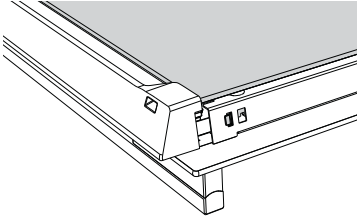

Push the glass retainer tabs in on both sides of the door. Pull the glass retainer up until the tabs relocate in the uppermost hole.

2

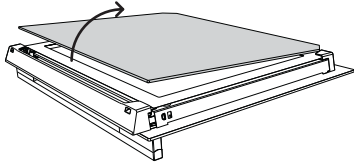

Holding the top of the inner pane, gently pull the pane toward the top of the door until the pane is clear of the notch at the bottom of the door and lift out. Do not angle the pane too much as you may damage the glass.

### To remove the middle pane

1

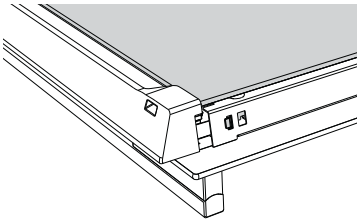

Push the glass retainer tabs in on both sides of the door again. The glass retainer can then be pulled off completely. Gently pull the middle pane toward the top of the door until the pane is clear of the notch at the bottom of the door.

2

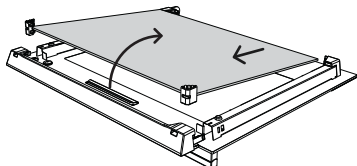

Gently pull the middle pane toward the top of the door until the pane is clear of the notch at the bottom of the door. Lift the pane out. The rubber stoppers at the top of the pane remain attached to the glass pane.

## CARE AND CLEANING

### When replacing the glass panes make sure that:

- you replace the inner pane correctly as shown to ensure that the oven operates safely
- you take extra care not to bump the edges of the glass against any object or surface
- you do not force any of the panes into place. If you are experiencing difficulties replacing the panes, remove and start the process again. If this does not help, call Customer Care.

### Replace the middle pane

Ensure the pane is the right way up (warning text at the bottom of the pane should face to the front of the door during installation but should not be visible once installed).

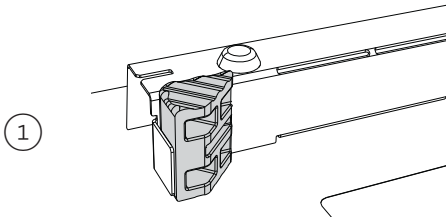

Ensure the rubber stoppers are still attached at the top of the pane. Ensure they are positioned correctly on the glass with the longer side running down the side of the glass pane.

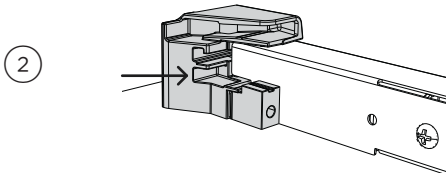

Slot the bottom of the pane into the lower notch at the bottom of the door.

Lower the pane into the door, the rubber stoppers rest on the outer pane of glass.

### Replace the inner pane

Ensure the pane is the right way up (the logo should be readable at the bottom of the door).

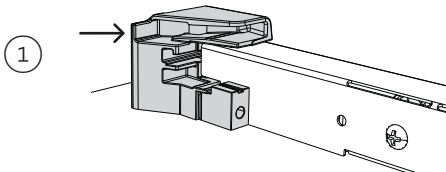

Slide the pane into the notch at the bottom of the door and lower the pane onto the notch at the top of the door.

Slide the glass retainer back into place and ensure it is clipped securely in place.

**IMPORTANT!**  
Ensure the glass retainer is correctly and firmly in place and the glass pane is secure.

## USING SELF CLEAN

Self Clean takes care of the mess and grime that is traditionally associated with oven cleaning. The extremely high temperature of the pyrolytic clean cycle burns off and breaks down grease and grime deposits. All that is left is a small amount of ash that can easily be wiped up.

There are two clean cycles available:

**STANDARD CLEAN** (4 hours)  
For normal or heavy soiling

**LIGHT CLEAN** (3 hours)  
For light soiling

### IMPORTANT!

- You must clean the inside glass door panel **BEFORE** starting a clean cycle. Failure to do so may result in permanent staining or marking of the door glass. See 'Care and cleaning' for our recommendations on how to do this.
- Do not use oven cleaners, any degreasing cleaners, or oven liners.
- Remove all oven shelves, trays, bakeware and utensils from the oven before starting a clean cycle (except side racks). If left in the oven they will be permanently damaged; items made from combustible material (eg wood, fabric, plastic) may even catch fire.
- Do not use your oven to clean miscellaneous parts.
- Make sure the room is well ventilated.
- Before starting a clean cycle, make sure you move any pet birds to another, closed and well-ventilated room. Some pet birds are extremely sensitive to the fumes given off during a clean cycle, and may die if left in the same room.
- During a clean cycle, the oven reaches higher temperatures than it does for cooking. Under such conditions, the surfaces may get hotter than usual and children should be kept away.
- The oven door will be locked during the clean cycle.
- If there are cracks or flaws on any of the oven door glass panes, if the oven seal is damaged or worn, or if the door does not close properly, do not start a clean cycle. Contact a Fisher & Paykel trained and supported service technician or Customer Care.

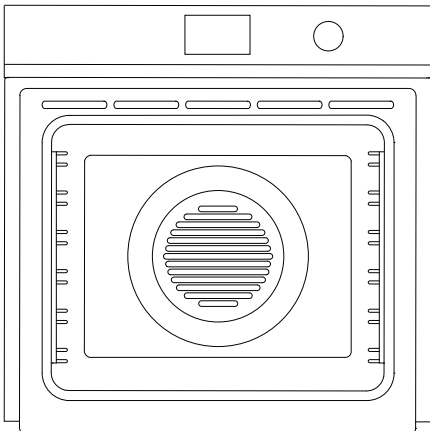

### Before you start

- ① Remove all shelves, accessories and utensils. You do not need to remove the side racks.
- ② Wipe up any spills, and along the inner edge of the oven surface around the seal. Failure to do so may discolor the oven surface.

**Avoid cleaning the seal itself as this may cause damage.**

- ③ Check the inner glass pane of the oven door. If it has soiling on it, you will need to clean it manually before starting a Clean cycle. For instructions, see 'Care and cleaning'.

**If soiling is left on the glass, it will become burnt on during the clean cycle, making it very difficult to remove.**

- ④ Close the oven door firmly.

# USING SELF CLEAN

## Setting Self Clean

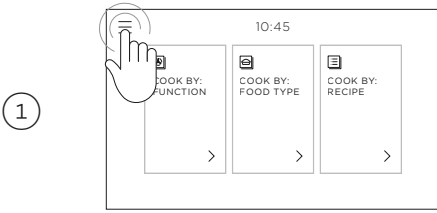

Touch the menu icon in the top left corner of the screen.

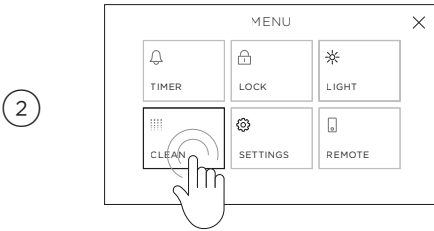

Select **CLEAN**.

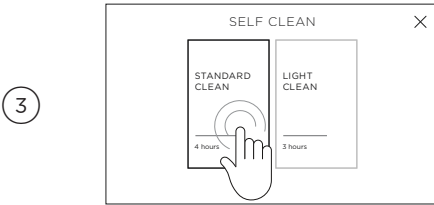

Select **STANDARD CLEAN** or **LIGHT CLEAN**.

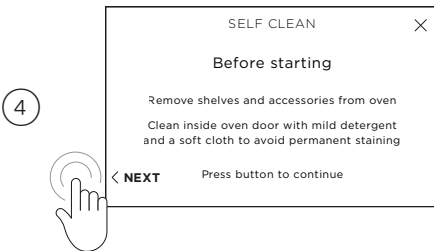

Follow the on-screen instructions and press the upper button to the right of the screen to continue.



Press the middle button to the right of the screen to start the clean cycle.

For your safety, the oven door will be locked shut during the cycle. If the door is not shut properly or is reopened before Self Clean starts, the cycle will be cancelled.

## USING SELF CLEAN

### Cancelling Self Clean

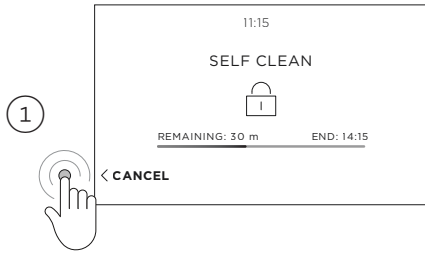

Press the button to the left of the screen at any point during the clean cycle to cancel.

### IMPORTANT!

- The oven door will not unlock until the oven has cooled to a safe temperature. DO NOT turn off the mains power supply to the oven (wall switch). Turning off the power while the oven is too hot may damage the oven and its surrounding cabinetry.
- We do not recommend cancelling Self Clean then immediately starting another cycle.

### When Self Clean is finished



SELF CLEAN COMPLETE will show in the display. Touch the display to clear.

### You need to:

- wait for the oven to cool down completely
- remove the grey ash with a small brush or damp cloth
- wipe out the oven with a clean, damp cloth
- dry with a clean, lint-free cloth, and
- replace the oven shelves.

## TROUBLESHOOTING

If there is a problem with your oven, please check the following points before contacting your local Fisher & Paykel trained and supported service technician or the Customer Care Centre.

### General

PROBLEM	POSSIBLE CAUSES	WHAT TO DO
The oven does not work	No power.	Check that the mains power supply (wall switch) is turned on, the fuse has not tripped and there is no power outage in your area.
The oven does not work but the screen is on.	The oven is in Demo Mode.	Call Customer Care.
The lights do not come on when I open the oven door.	The oven light bulb(s) have blown.	Replace the light bulb(s). See 'Care and cleaning' for instructions.
	The door is not correctly fitted.	See 'Care and cleaning' for instructions on fitting the door correctly.
	The oven light has been turned off.	Go to the menu in the top left corner of the screen and select <b>LIGHT</b> .
The oven controls are unresponsive.	The control panel is locked.	Touch and hold the screen to unlock.
The oven is not heating.	The door is not properly closed or it is opened too frequently during cooking.	The heating elements are disabled while the door is open. Make sure the door is properly closed and avoid opening it frequently during cooking.
A glass pane in the oven door has cracked, chipped, or shattered.	Incorrect cleaning or the edge of the glass hitting against something.	You must <b>NOT</b> use the oven. Contact a Fisher & Paykel trained and supported service technician or Customer Care
I can feel hot air blowing out of the vents after I have turned the oven off.	This is normal.	For safety reasons the cooling fans will continue to run even when you have turned the oven off. The fans will switch off automatically when the oven has cooled.



## TROUBLESHOOTING

### General

PROBLEM	POSSIBLE CAUSES	WHAT TO DO
The oven fan comes on when I select a function that does not use a fan (eg <b>BAKE</b> or <b>CLASSIC BAKE</b> ).	This is normal. The fan comes on while the oven is preheating. It may turn off when the oven has reached the set temperature.	Wait until the red heating bar on the screen disappears: the oven will then be ready to use.
The oven fan comes on when I select a function that does not use a fan (eg <b>BAKE</b> or <b>CLASSIC BAKE</b> ).	This is normal: when heating up from cold, your oven is designed to initially heat to a temperature somewhat higher than what you have set. This is to provide optimal baking conditions right from the start.	Wait until the red heating bar on the screen disappears: the oven will then be ready to use.
The oven has reached the set temperature but the temperature dial halo is still red.	The oven is set to <b>GRILL</b> .	This is normal. The dial halo will stay red whenever this function is in use as the grill element is always heating.
The oven sounds a tone when I try to set the temperature below a certain temperature.	This is normal: for food safety reasons, the oven functions have factory-set minimum temperature settings.	Select a different temperature or try a different function that is designed for low temperatures.
The temperature dial halo never turns white when I use <b>GRILL</b> .	This is normal: the halo stays red to indicate that the grill element provides instant radiant heat.	

## TROUBLESHOOTING

### Self Clean

PROBLEM	POSSIBLE CAUSES	WHAT TO DO
During Self Clean, the oven is louder than usual.	This is normal: the oven's cooling fans operate at their highest speed.	
The screen shows no time remaining but the oven door will not open.	The oven door is locked because the oven is still too hot to be used for cooking.	Wait until Self Clean has finished. If you cancelled a cycle part way through, the oven still needs to cool down before it can be used. The oven door will automatically unlock.
I have cancelled Self Clean but cannot use the oven: <ul style="list-style-type: none"><li>the oven door will not open</li><li>the screen is still counting down minutes or showing no time remaining</li><li>the controls are unresponsive.</li></ul>	This is normal. If the oven is still too hot to be used for cooking the door will stay locked until it has cooled down.	Wait until the cool-down phase has finished. A long tone will sound and the oven door will automatically unlock when the oven is ready to use.  Note: depending on when the clean cycle was cancelled, the cool-down phase may take up to 45 minutes.
The oven is beeping and the screen shows A2 or A3.	See section 'Alert codes' for instructions.	Follow the guidance on the screen.
There is a power cut during Self Clean.	Power cut.	The heating elements are disabled while the door is open. The door will remain locked. Once the power is turned back on, the door will remain locked until the oven has cooled to a safe temperature.

## ALERT CODES

If there is a problem, the oven will automatically suspend all oven functions, beep five times and display an alert code.

### IMPORTANT!

**Do not turn off the mains power supply to the oven (wall switch) if you get an alert code, unless the instructions in the chart following specifically instruct you to. There are cooling fans within the oven which are needed to cool the oven's components. Turning off the power while the oven is too hot may damage the oven and its surrounding cabinetry.**

#### What to do if an alert code is displayed

- ① If the beeping hasn't stopped already, touch the display and press the little audio button in the bottom right to mute it.
- ② Make a note of the alert code displayed. You may need this information.
- ③ Follow the instructions on the screen to resolve the problem.
- ④ If you can fix the problem and the alert code does not reappear, you may continue using your oven.

If you can't fix the problem yourself or the alert code reappears and the problem persists: wait until the cooling fans have stopped and the oven has completely cooled down, then turn the power to the oven off at the wall and contact a Fisher & Paykel trained and supported service technician or Customer Care with the alert code information.

ALERT CODE	POSSIBLE CAUSE	WHAT TO DO
A1	The oven has overheated.	<ul style="list-style-type: none"><li>• Allow the oven to cool down.</li><li>• Once the oven has cooled down and the door has unlocked, the alert code will disappear. You can now use the oven.</li></ul>
A2	Door lock error: the door cannot be locked after you have started a Self-clean cycle.	<ul style="list-style-type: none"><li>• Turn the power to the oven off at the wall and on again.</li><li>• Wait approximately 10 seconds. This will allow the door lock to return to its initial position.</li><li>• Set the clock. See 'Setting the clock and first use' for instructions.</li><li>• Try starting a Self Clean cycle again, making sure that you close the door firmly. See 'Using Self Clean'.</li></ul>
A3	Door lock error: the door cannot be unlocked after a Self Clean cycle has finished.	<ul style="list-style-type: none"><li>• Turn the power to the oven off at the wall and on again.</li><li>• Gently press the door a few times to help the door lock disengage.</li><li>• If this doesn't help and the alert code reappears, contact a Fisher &amp; Paykel trained and supported service technician or Customer Care.</li></ul>
F + number	Technical fault.	<ul style="list-style-type: none"><li>• Note down the alert code.</li><li>• Wait until the cooling fans have stopped and the oven has completely cooled down.</li><li>• Turn the power to the oven off at the wall.</li><li>• Contact a Fisher &amp; Paykel trained and supported service technician or Customer Care.</li></ul>

## FOOD CONTACT MATERIALS DECLARATION

This appliance contains the following food contact parts and meets the requirements of GB 4806.1-2016 and related national standards for food safety. It is suitable to contact foods. Please follow the instructions when using the product.

<b>PART NAME</b>	<b>DESCRIPTION</b>	<b>MATERIAL</b>	<b>COMPLIANCE STANDARD</b>
Enamel tray	Black enamel	Metal and enamel	GB4806.3-2016
Enamel liner	Black enamel	Metal and enamel	
Enamel fan shroud	Black enamel	Metal and enamel	
Oven door Seal	Black silicone rubber	Silicone rubber	GB4806.11-2016
Hose silicone drain steam generator	White translucent silicone rubber	Dimethyl siloxane	
Manifold mount pump steam	White translucent silicone rubber	Dimethyl siloxane	
O ring BS007S70	Black nitrile rubber	Nitrile rubber	
Seal lid tank water	White translucent sealing ring	RBL-2004-40	
Solenoid pump-diaphragm	Black nitrile rubber	NBR	
Hose silicone	White translucent silicone	Silicone rubber	
Inside glass of the door	Clear glass	Tempered glass	GB4806.5-2016
Lamp cover on oven liner	Clear glass	Glass	
Joiner barbed water steam	White plastic	POM	GB4806.7-2016
Solenoid pump – water tube	Beige plastic	PA66	
Solenoid pump – plastic cover	White plastic	POM	
Tank water	Blue transparent plastic	Luran 368R SAN	
Valve plunger water drawer	Black plastic	PA12	
Float pivot cover arm	Black plastic	PA12	
Water reservoir	Black plastic	PPS	

## FOOD CONTACT MATERIALS DECLARATION

<b>PART NAME</b>	<b>DESCRIPTION</b>	<b>MATERIAL</b>	<b>COMPLIANCE STANDARD</b>
Upper heating pipe	Silver coloured metal	Stainless steel 309s(06Cr23Ni13)	GB4806.9-2016
Temperature transducer	Silver coloured metal	Stainless steel	
Temperature transducer holder	Silver coloured metal	Electroplating, chrome plating/zinc plating	
Heating pipe holder	Silver coloured metal	Stainless steel 304(06Cr19Ni10)	
Steam generator	Silver coloured metal	Stainless steel 304(06Cr19Ni10)	
Steam generator cover	Silver coloured metal	Stainless steel 304(06Cr19Ni10)	
Electroplating grill	Silver coloured metal	Electroplating (copper plating/nickel plating/ chrome plating)	
Rack screw nut	Silver coloured metal	Stainless steel 304(06Cr19Ni10)	
Rack screw bolt	Silver coloured metal	Stainless steel 304(06Cr19Ni10)	
Steam generator tube	Silver coloured metal	Stainless steel (316)	

Some models may not contain some materials mentioned above. Please refer to the actual product. Please remove the packaging materials within the oven before using the product. This product is not intended to be used for long-term food storage.

## MANUFACTURER'S WARRANTY AND SERVICE GUIDE

---



### To access your Warranty and Service Guide

Scan the QR code with your smartphone to access your warranty and book a service, or view online at <https://www.fisherpaykel.com/cn/help-and-support/warranty-information>

This product has been designed for use in a domestic (residential) environment. This product is not designed for any commercial use. Any commercial use by the customer will affect this products Manufacturer's Warranty.

### Complete and keep for safe reference:

Model \_\_\_\_\_

Serial No. \_\_\_\_\_

Purchase Date \_\_\_\_\_

Purchaser \_\_\_\_\_

Dealer \_\_\_\_\_

Suburb \_\_\_\_\_

Town \_\_\_\_\_

Country \_\_\_\_\_

**FISHERPAYKEL.COM**

© Fisher & Paykel Appliances 2024. All rights reserved.

The models shown in this guide may not be available in all markets  
and are subject to change at any time.

The product specifications in this guide apply to the specific products and  
models described at the date of issue. Under our policy of continuous product  
improvement, these specifications may change at any time.

For current details about model and specification availability in your country,  
please go to our website or contact your local Fisher & Paykel dealer.

**431228A 02.24**