

FISHER & PAYKEL

**FRONT LOADING
CLOTHES WASHER**

WH1260F1 model

INSTALLATION GUIDE / USER GUIDE

NZ AU

CONTENTS

Introduction	2
Safety and warnings	3
Installation instructions	5
Before your first wash	13
Safety features	14
Control panel	15
Wash cycles	17
ActiveIntelligence™	19
Auto and manual dose	20
Wash preparation	21
Getting started quickly	23
Customising a wash cycle	24
Caring for your washer	30
Before you call for service	34
Fault codes	35
Troubleshooting	36
Manufacturer's warranty	42
Customer care	44

IMPORTANT! **SAVE THESE INSTRUCTIONS**

The models shown in this User guide may not be available in all markets and are subject to change at any time. For current details about model and specification availability in your country, go to our website fisherpaykel.com or contact your local Fisher & Paykel dealer.

Registration

Register your product with us so we can provide you with the best service possible.

To register your product visit our website: fisherpaykel.com

INTRODUCTION

Welcome

Thank you for buying a Fisher & Paykel clothes washer. We are proud of this washer and trust it will serve you well for many years.

At Fisher & Paykel, we aim to provide innovative products that are simple to use, ergonomic and environment-friendly. Your washer has ActiveIntelligence™ technology with numerous wash cycles and options, so you can perform every wash task easily and in the knowledge your clothes are receiving the best possible care.

Take the time to read these instructions carefully before you begin using your washer.

Follow the instructions in this User guide to ensure you get the performance you expect from your washer and the best possible wash results. Keep this manual for future reference.

We hope you enjoy your new washer. We have certainly enjoyed designing it for you.

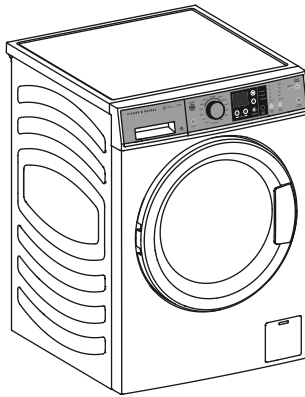

Front loading washer model

⚠ WARNING!



Electrical Shock Hazard

Failure to follow this advice may result in electrical shock or death.

- If you are using an extension cord or a portable electrical outlet device (eg multi-socket outlet box), ensure that it is positioned so that it does not come into contact with water or moisture.

IMPORTANT SAFETY INSTRUCTIONS

WARNING! When using your clothes washer, follow basic precautions, including the following:

General

- This product has been designed for personal, family or household use. This product is not designed for any commercial use. Any commercial use will terminate this products manufacturer's warranty.
- A damaged power cord must be replaced by a Fisher & Paykel trained and supported service technician or similarly qualified person in order to avoid a hazard. Do not use the appliance until it has been repaired to avoid a risk of electric shock.
- Do not operate this machine if it has been damaged during transport. Contact your Fisher & Paykel dealer or Fisher & Paykel trained and supported service technician.
- This clothes washer is not intended for use by persons (including children) with reduced physical, sensory or mental capabilities, or lack of experience and knowledge, unless they are supervised or given instructions on how to use the washer by someone responsible for their safety.
- Keep children away from the washer while it is in operation.
- Supervise children to ensure they do not play with the washer or climb inside the drum.
- The washer should only be used for washing and rinsing of textiles where this is indicated on the care label.
- Do not add petrol, dry-cleaning solvents, or other flammable or explosive substances to the wash water. These substances give off vapours that could ignite or explode.
- Do not wash articles that have been previously cleaned in, washed in, soaked in, or spotted with gasoline, dry-cleaning solvents, or other flammable or explosive substances as they give off vapours that could ignite or explode.
- The door will be locked from the start of the cycle until the cycle is complete for safety reasons. It is possible to open the door during the cycle under certain conditions. Never force the door open.
- Do not touch the door during a cycle as the door can become hot.
- When 90°C temperature is selected, the door glass will become hot. Do not touch the glass part of the door. Keep children away from the washer.
- Do not touch or operate the machine with wet hands or with bare-feet.
- Do not open the detergent dispenser during the cycle as hot water may come out of it.

SAFETY AND WARNINGS

- **Do not overload your washing machine beyond its rated capacity.**

Model	Maximum capacity
WH1260F1	12Kg

- Do not wash an electric blanket in your washer unless the care label specifically states it is safe to do so.
- Do not wash curtains in this washer, as sunlight makes them brittle and they may disintegrate during washing.
- The only user-removable parts of the washer are the inlet hose(s), detergent dispenser and the pump filter. No other parts are designed to be removed by anyone other than a Fisher & Paykel trained and supported service technician.

Installation

- For guidance on how to install your product, please refer to installation instructions contained in this document.

Water supply requirements:

- Inlet water pressure: Max. 1MPa (150psi), Min. 50kPa (7.2psi)
- Inlet water flow rate: Min. 8 litres/minute
- A pressure-reducing valve must be installed if pressure is higher than 1MPa.
- For optimum wash performance check the supply pressure is within the recommended range.
- New hose sets provided with the washer should be used to connect the washer to the water mains. Old hose sets should not be re-used.
- We recommend the inlet hose(s) are changed every 5 years. **WARNING:** Failure to do so may result in a flood and damage to property.
- The hot water temperature should not exceed 65°C and the cold water temperature not exceed 35°C. Temperatures above these may cause the machine to fault or cause damage to the machine.
- Install the machine on a solid and level floor surface ensuring it has at least 20 mm clearance on each side. The washer must not be installed on any textured floor coverings (eg carpet, rugs).

Disposal

- When disposing of the washer, it is recommended that the door is removed to avoid children getting trapped inside, and that the electrical cable is cut off close to the washer.

INSTALLATION INSTRUCTIONS

Accessories

Check if you received the following accessories with your Fisher & Paykel washer. You will find them inside the drum or attached to the packaging.

- 2 x Inlet hose(s)
- 1 x Inlet valve cap
- 1 x Drain hose guide
- 1 x Installation instructions and User guide
- 1 x Spanner
- 1 x Installation leaflet (attached to the top of the washer)

Unpacking

To ensure the best performance from your new washer please follow the instructions below.

Removing the packaging

- ① Remove the outer packaging (including the expanded polystyrene packer and plastic wrapping). All packaging must be removed prior to use. Ensure these materials are kept out of reach of children. Note: a small amount of water may be seen inside the packaging and inside the washer. This is the result of factory testing and is normal.
- ② Tilt the washer backwards and 'walk' it off the base one foot at a time. Not doing so may cause damage to your floor and washer.
- ③ Remove all packaging and accessories from inside the drum.

Removing transit safety bolts

The clothes washer is fitted with transit safety bolts at the rear to avoid possible damage to the interior during transportation.

The transit bolts MUST be removed prior to operation of the washer. Failure to remove these will result in damage to the washer.

Note: the transit bolts MUST be removed in order to use the power cord.

To remove the bolts

- ① Use a spanner or socket to unscrew and remove all 4 transit bolts at the back of the washer (**A**).
- ② Pull the black rubber grommets to remove the bolt, grommet and white plastic spacers from the washer (**B**). Retain these for future use.

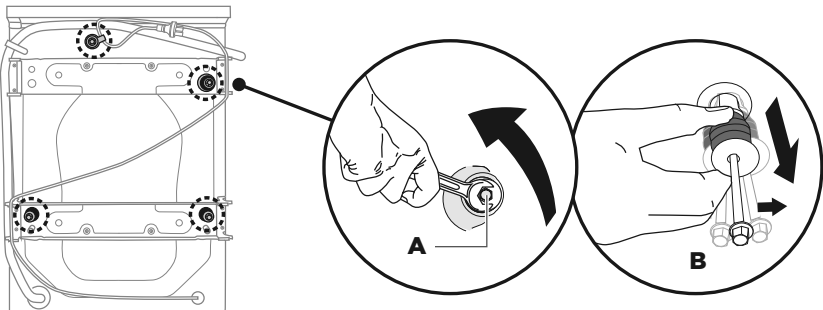

Removing the transit safety bolts

INSTALLATION INSTRUCTIONS

- ③ Detach the drain hose from the plastic clasp, and remove the clasps on the side of the transit braces.

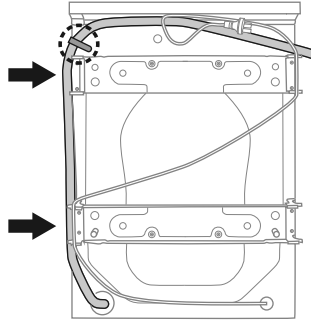

Removing the drain hose

- ④ Remove the 10 transit brace screws from the left and right sides, and near the centre of the top brace (refer to **C**).
- ⑤ Remove the braces (refer to **D**). Keep the braces and screws for future use.

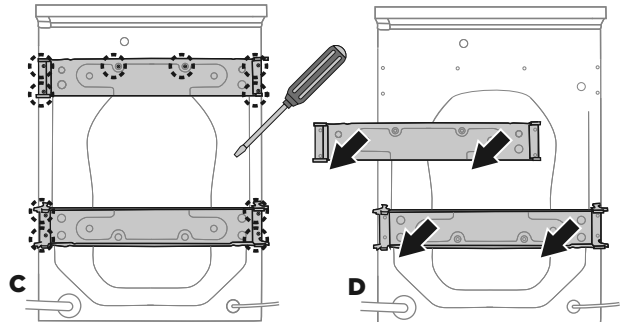

Removing the transit brace screws

Removing the braces

- ⑥ Pull out the two transit rods located below the two lower transit bolt holes and retain for future use (refer to **E**).

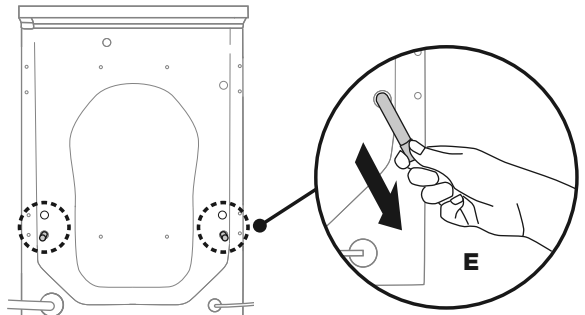

Removing the transit rods

- ⑦ Remove the yellow safety clip from the power cord.
- ⑧ Cover the transit bolt holes with the plastic plugs (provided). Push to clip into place (refer to **F**).

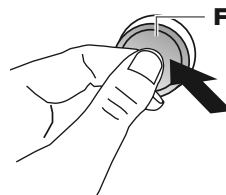

Covering bolt holes with plastic plugs

INSTALLATION INSTRUCTIONS

Product dimensions

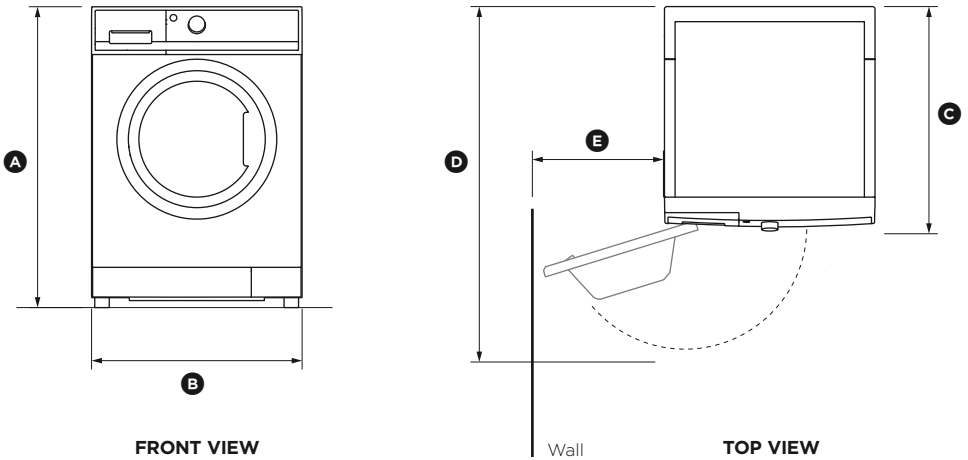

PRODUCT DIMENSIONS		mm
(A)	Overall height of product	850
(B)	Overall width of product	600
(C)	Overall depth of product (including dial and door when closed)	665
(D)	Depth with door open	1110
(E)	Minimum door clearance to adjacent wall	340
	Standpipe or spigot height	600-000
MAXIMUM CAPACITY		kg
		12

Note: the exact height of your washer is dependent on how far the feet are extended from the base of the washer. The space where you install your washer needs to be at least 40mm wider and 20mm deeper than its dimensions.

- Electrical supply: 220-240V, 50Hz sinusoidal, minimum 10A.
- Inlet water static pressure: Max. 1MPa (150psi), Min. 50kPa (7.2psi).
- Inlet water flow rate at tap: Min. 8 litres/min.
- A pressure-reducing valve must be installed if pressure is higher than 1MPa.
- For optimum wash performance check the supply pressure is within the recommended range.

INSTALLATION INSTRUCTIONS

Location

This washer must not be installed and operated on a plinth.

When relocating your washer, first remove the detergent drawer. This will avoid any spillage of detergent from tipping the appliance.

Levelling the washer

It is IMPORTANT to level the washer to ensure good spin performance, and to minimise noise, vibrations and wear and tear on the washer.

- ① Before positioning the washer in its final position, check that it is level, front to back and side to side.
- ② Adjust the product into its final position (we suggest a minimum clearance of 20mm each side).
- ③ Use a spirit level to check that the washer is correctly level. If needed, pull the washer out. Loosen the lock nut using the spanner provided and wind the feet up or down to correctly level the washer.
- ④ Using the spanner provided, tighten the lock nuts against the base of the washer to lock the feet in position.

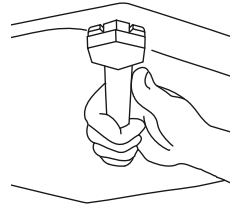

Locking the feet

Connecting to the water supply

Inlet hoses

- ① Connect the straight ends of the inlet hoses to the taps.
- ② Connect the elbow ends to the corresponding washer inlet valves. The hot valve is coloured orange to make this easier.
- ③ Tighten the inlet hose ends by hand until the hose seal just makes contact with the tap sealing face. Continue to tighten a further half-turn. Make sure there are no kinks in the hoses.
- ④ Turn the taps on and check for leaks. Check for leaks again after 24 hours.

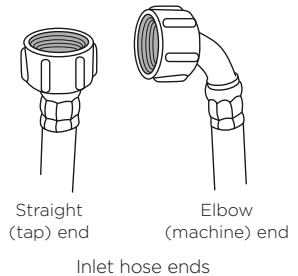

INSTALLATION INSTRUCTIONS

If you have an uncontrolled water heating source (eg a wet back or solar heating system) you should fit a Hot 'N' Safe Valve. This will ensure the hot water temperature remains within safe limits.

Hot 'N' Safe Valves available are:

RMC TVA 50HF

RMC TVA 75HFS

Adjustable between 35°C – 55°C

RMC TVA 50HP

For instantaneous gas hot water supply

Water supply requirements:

- Inlet water pressure: Max. 1MPa (150psi), Min. 50kPa (7.2psi)
- Inlet water flow rate: Min. 8 litres/minute
- A pressure-reducing valve must be installed if pressure is higher than 1MPa.
- For optimum wash performance check the supply pressure is within the recommended range.

Cold supply only:

If you only have a cold water supply, the inlet valve cap (blanking cap) that came with your washer must be connected to the hot inlet valve. The cap prevents water leaking out of the hot valve. This appliance incorporates backflow protection complying with IEC61770. No further backflow protection is required for connection to the water supply.

Note: Your washer has an internal heater to heat water. If you do not connect a hot water inlet hose, your washer will automatically recognise there is no hot water supply and its internal heater will heat the cold water to the selected cycle temperature.

INSTALLATION INSTRUCTIONS

Draining

Placing the drain hose in a standpipe or tub

- ① To guide the drain hose over the tub or standpipe, the hose guide must be fitted to the drain hose. The height of the standpipe or tub should be between 600-1000mm.
 - ② Secure the hose guide so it cannot be dislodged from the standpipe or tub.
- If the drain hose is placed on the ground or if the standpipe or tub is less than 600mm high, the washing machine will continuously drain while being filled (siphon).
 - Regularly check that your standpipe or tub is free from lint or other obstructions, which may affect how your washer works or may cause flooding.

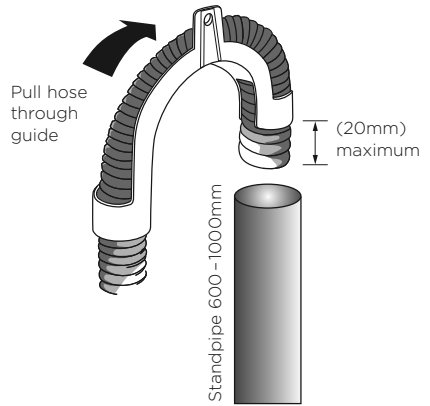

Fitting the drain hose guide

Attaching drain hose to spigot

- ① Guide the drain hose through the hose guide.
 - ② Secure the hose guide to the back wall of cupboard using a screw. The height of the drain hose should be between 600-1000mm from ground level.
 - ③ Attach the drain hose to the spigot and secure using a hose clamp to ensure the blanking insert is cleared from the spigot.
 - ④ Check for leaks.
- The drain hose should be checked from time to time and replaced if any damage (eg wear, cuts, bulges, kinks, leaks, etc) is found. Do not bend the drain hose sharply, as this may cause it to split.
 - In multi-storey apartments or any upper floor, the washer should be installed on a floor equipped with a drain.
 - Draining must comply with local by-laws.

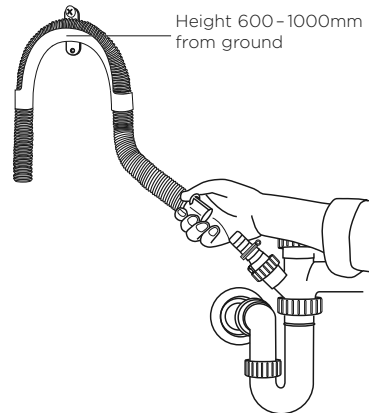

Attaching drain hose to spigot

INSTALLATION INSTRUCTIONS

Electrical connection

- ① This appliance must be connected to a 220V - 240V, 50Hz, sinusoidal, minimum 10A electrical supply.
 - ② Release the power cord (transit bolts must be removed).
 - ③ Remove and discard the plastic pin cover and plug into a wall socket.
 - ④ Connect the appliance to an earthed outlet protected by a fuse of suitable capacity.
- Check the power cord for damage and make sure it is not squashed or twisted when installing the washer.
 - Always remove the power cord from a socket by the plug, not by the cord.

SPARE PARTS*	Part No.
Hose inlet long (2m)	422680P
Hose inlet large bore	426123P
Drain hose extension (not suitable for attaching to a spigot)	425627P

*Available from your Fisher & Paykel dealer or a Fisher & Paykel trained and supported service technician.

INSTALLATION INSTRUCTIONS

Completing the installation

Installation test cycle

Do this before you wash any items in your washer. This is to check that your washer is installed correctly and that it is functioning properly prior to use. We recommend you complete an initial manual cycle with an empty drum and half a dose of detergent in order to remove any residues from the manufacturing process.

- ① Turn your washer on by pressing the 'POWER' button.
- ② Select 'Manual' and put half a dose of detergent into the 'Manual Dose' compartment.
- ② Select the 'Quick 30' cycle. Ensure the drum is empty and the door closed.
- ③ Touch the ►|| button. The washer will start to fill.
 - Observe the washer for any problems (eg leaking from the hoses, excess noise or vibrations).
 - The washer will beep and display any faults on the screen if there are any problems. Refer to the 'Before you call for service' at the back of this book.
- ④ Continue to observe until you see water in the bottom of the drum.
- ⑤ Touch ►|| to pause the cycle, then press 'POWER' to turn the washer off.
- ⑥ Press 'POWER' again, select the 'Spin' cycle and touch ►||.
 - Check that the drain hose is firmly secured to the standpipe, or tub or spigot.
 - Observe that the washer pumps out the water and spins.

If there are any problems, you must address these before proceeding with normal use. The washer will automatically turn off at the end of the cycle if there are no problems.

BEFORE YOUR FIRST WASH

Before you start, mark (✓) accordingly if you have gone through the checklist below:



-
- ① Have the packaging and transit bolts been removed?

 - ② Is the drain hose threaded through the hose guide 'U bend' (with no more than 20mm extended) and hooked into your standpipe or tub, or attached to a spigot?

 - ③ Is the hot water hose connected to the hot valve (colour-coded orange)?

 - ④ Is the cold water hose connected to the cold valve (colour-coded grey)?

 - ⑤ Have the taps been turned on?

 - ⑥ Is the washer correctly levelled, feet are locked and cabinet corners clear of the floor and walls?

 - ⑦ Has the power cord been connected to an appropriate power supply and the power turned on?

 - ⑧ Have you performed the installation test cycle? (see previous page)

SAFETY FEATURES

Door lock

The door of your washer will lock once you touch ►|| and will stay locked until the washer beeps at the end of the cycle, ensuring safety for you and your family while your washing machine is operating.

Unlocking the door during the cycle

You can open the door to add or remove items during the wash simply by touching the ►|| button.

The door will remain locked if the temperature inside the washer is above 60°C and/or the water level is above the bottom of the door seal (a warning will be displayed in these circumstances, refer to 'Before you call for service').

To open the door

- ① Touch ►|| to pause the washer.
 - The door will automatically unlock if the conditions inside the washer are safe.
 - The ►|| button and the time remaining will flash on the screen while the washer is paused.
- ② Open the door to remove or add garments.
- ③ Close the door and touch ►|| to resume the cycle.

Opening the door during a power failure

If there is a power failure during a wash cycle your washer will stop and the door will remain locked. You can unlock the washer door to remove your clothes by opening the pump filter cover at the bottom right of your washer. Simply place a coin or key in the slot and tilt it upwards to lever the cover open. Use a tool (ie key or screw driver) to pull the door release tab down.

Do not attempt to do this if the water level in the washer is above the bottom of the door.

When power is restored, your washer will resume its interrupted wash cycle.

Your washer also has the following protective measures:

- Flood protection—turns off valves and turns pump on if a flood condition is detected.
- Out-of-balance protection—stops and redistributes the load if an unbalanced load is sensed, and/or slows the spin speed to compensate.
- Excess suds protection—pauses to allow suds to break down before continuing the cycle.

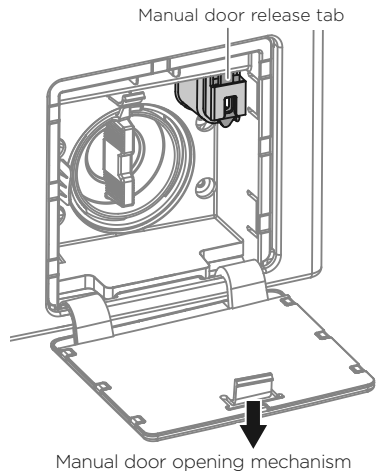

CONTROL PANEL

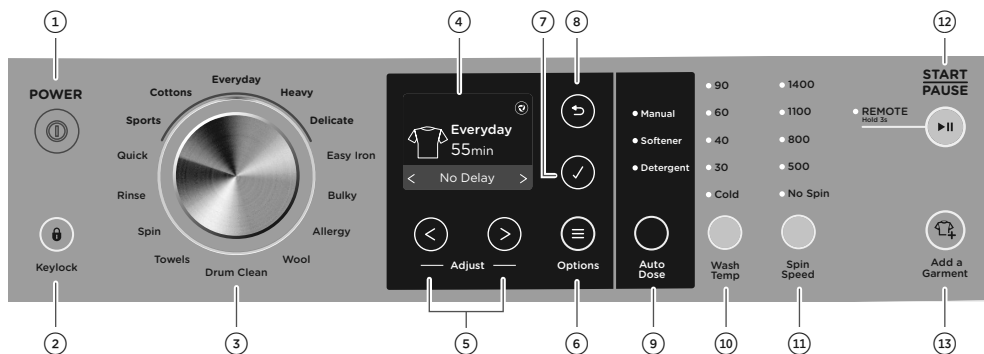

①	POWER	Press to turn the washer ON/OFF.
②	Keylock	Touch to disable all buttons on the display panel, except 'POWER' button. This prevents accidental button presses.
③	SmartTouch™ Control Dial	<p>Rotate to select your desired wash cycle.</p> <ul style="list-style-type: none"> Red LED illuminates to indicate the selected wash cycle. Selected wash cycle information is shown on the main display screen.
④	Digital display screen	<p>Shows the following:</p> <ul style="list-style-type: none"> Wash cycle icons and information based on dial selection. Wash cycle options and machine settings. Wash progress. Delayed start time of wash cycle. Notifications if an error is detected or a warning is necessary.
⑤	Adjust	Touch to navigate through the wash cycle options and settings, and to increase or decrease the delay start time.
⑥	Options	Touch to access wash cycle options and washer settings.
⑦	Select	Touch to accept the selected option or any changes made, and then return to the main screen.
⑧	Back	Touch to exit current display and return to the main screen. Changes will not be saved if the ✓ button is not selected first.
⑨	Auto Dose	Touch to select 'Manual' or 'Auto Dose' dispensing of detergent and softener.
⑩	Wash Temp	Touch to increase or decrease water temperature.
⑪	Spin Speed	Touch to increase or decrease washer spin speed.
⑫	START/PAUSE REMOTE	Touch to start or pause the selected wash cycle. WiFi/REMOTE is not available on this product.
⑬	Add a Garment	Touch to interrupt the wash part of the cycle to add or remove a garment.

CONTROL PANEL

Add a Garment



The 'Add a Garment' option enables you to add or remove items during the wash stage of the cycle, under certain conditions.

- Once the 'Add a Garment' button is touched, the ►|| button will flash along with the time on the display screen. Wait until you hear the door unlock.
- Open the door and add or remove items. Close the door and touch ►|| to restart the cycle.
- The 'Add a Garment' button will only operate during the wash part of the cycle and when the temperature selected is lower than 60°C. 'Add a Garment' can still be used if the water level is above the bottom of the door, as your washer will drain the water to a lower level so the door can be opened.

Keylock

This option enables you to deactivate the buttons on the display panel, except for the 'POWER' and 'Keylock' buttons. This prevents accidental button presses. The display panel will notify you when 'Keylock' is ON or OFF.

To turn Keylock mode ON or OFF when the washer is powered on:

- Touch and hold  button for 3 seconds. You will hear a beeping sound, a notification will show on the display screen, and  button will illuminate to indicate 'Keylock' is active.

If Keylock mode is activated and the washer is powered off:

- To turn your washer on, press 'POWER' button, then touch and hold the  button for 3 seconds to deactivate 'Keylock'. Select your wash cycle, options and then touch ►|| to start the cycle.

Drum light

Your washer has a drum light to assist you with loading and unloading your washing. For your convenience, this LED light will automatically turn on for a short time when you press 'POWER', and at the end of a cycle while you unload all of your items from the washer.

WASH CYCLES

Wash cycle guide

Your washer has a number of wash cycles to suit your laundering needs. Selecting the most appropriate cycle for each particular wash load will help ensure you get the best wash result.

CYCLE	DESIGNED FOR	DESCRIPTION	MAX. LOAD SIZE (kg)	DEFAULT WASH TEMP. (°C)	MAX. WASH TEMP. (°C)	DEFAULT SPIN SPEED (rpm)*	MAX. SPIN SPEED (rpm)*
Everyday	Mixed, everyday items, eg towels, sheets, sweatshirts, t-shirts.	A cycle designed for mixed loads.	12	40	60	1400	1400
Cottons*	Normally soiled everyday cotton loads, eg whites.	A comprehensive cycle specifically designed for cottons.	12	40	90	1400	1400
Heavy	Heavily soiled durable garments eg tea towels, rugby shorts.	A stronger, hotter wash for more durable items.	12	60	90	1400	1400
Delicate	Delicate, lightly soiled items, eg tops, blouses.	Gentler wash with more water to look after delicate items.	5	30	40	500	800
Sports	Cotton/Synthetic sports clothing.	A cycle tailored to washing sports type clothing.	6	40	40	1100	1400
Easy Iron	Minimising creasing eg shirts, trousers.	Less spinning with 'Wrinkle Free' option to help minimise the need for ironing.	6	40	60	800	800
Bulky	Washing bulky items.	A warm, gentle wash and slow spin for special care of bulky items.	6	40	90	800	800
Allergy	Asthma sufferers and people with skin sensitivities.	Hot wash to kill dust mites and an extra rinse to remove all traces of detergent.	12	60	90	1400	1400
Quick 15	Lightly soiled garments.	A quick cycle for lightly soiled loads.	2	30	60	800	1400
Quick 30			6	40	60	800	1400

*'Cottons', Manual, 'Eco ON', '40°C', '1400 rpm', is the recommended water and energy saving cycle for a normally soiled load.

WASH CYCLES

CYCLE	DESIGNED FOR	DESCRIPTION	MAX. LOAD SIZE (kg)	DEFAULT WASH TEMP. (°C)	MAX. WASH TEMP. (°C)	DEFAULT SPIN SPEED (rpm)*	MAX. SPIN SPEED (rpm)*
Wool**	Machine washable woollen items.	Extra gentle wash action that complies with Woolmark Apparel Care criteria.	4	40	40	800	800
Towels	Towels.	A cycle specifically designed for washing towels.	6	40	90	1400	1400
Drum Clean	Maintaining the cleanliness of your washer.	A hot cycle to remove any residues inside the washer.	-	90	90	1400	1400
Spin	Spinning wet items.	Spin only.	12	-	-	1400	1400
Rinse	Items that require rinsing only.	Two rinses followed by a spin.	12	Cold	Cold	1400	1400

**Woolmark Apparel Care

The wool wash cycle of this machine has been approved by The Woolmark Company for the washing of machine washable wool products provided that the products are washed according to the instructions on the garment label and those issued by the manufacturer of this washing machine. M1766.



APPAREL CARE

ACTIVEINTELLIGENCE™

Your washer has ActiveIntelligence™ technology that optimises the wash cycle to clean your laundry more effectively and efficiently.

ActiveIntelligence™ technology allows the washer to:

- Sense both the size and soil level of your wash load.
- Dispense the right dose of detergent for each load.
- Determine the length of wash time best suited to individual wash loads.

Note: ActiveIntelligence™ is activated as a default setting when you first use your washer.

An  icon is shown at the top right corner of the display screen when ActiveIntelligence™ is activated.

For some wash cycles, ActiveIntelligence™ is activated by default. The display screen will show the  icon to indicate that the selected wash cycle is an ActiveIntelligence™ cycle.

The following are wash cycles with ActiveIntelligence™:

- Cottons
- Everyday
- Heavy
- Delicate
- Sports

The above wash cycles have some options that are not available when ActiveIntelligence™ is ON:

- Soak
- Eco
- Pre Wash
- Rinse+

For other wash cycles, ActiveIntelligence™ is not available so the icon will not be shown in the main display screen. For more information on activating/deactivating ActiveIntelligence™, refer to 'Customising Wash Cycle - ActiveIntelligence™'.

AUTO AND MANUAL DOSE

The washer has auto dosing compartments for liquid detergent and fabric softener, and a manual dosing compartment for powder or liquid detergent.

- **Auto Dose liquid detergent compartment**
Stores up to 1100ml (max) of liquid detergent suitable for several washes depending on load size.
- **Auto Dose fabric softener compartment**
Stores up to 540ml (max) of fabric softener suitable for several washes depending on load size.
- **Manual Dose liquid/powder detergent compartment**
For liquid or powder detergent used for single wash.

Auto Dose

Automatically dispenses the right amount of liquid detergent and fabric softener (optional) per wash cycle.

Use only liquid detergent for Auto Dose.

'Auto Dose detergent' is the default setting for all wash cycles (except 'Wool' and 'Drum Clean').

- If you select a wash cycle with ActiveIntelligence™, 'Auto Dose' will dispense the right amount of detergent based on soil level and load size.
- If you turn off ActiveIntelligence™, 'Auto Dose' will dispense the right amount of detergent based on load size.
- If you wish to add fabric softener, you need to select 'Softener' using the 'Auto Dose' button.

Note:

- Softener option is not available on the 'Quick 15' cycle.
- The amount of softener dispensed depends on load size for all other cycles.
- Auto dosing of fabric softener can be used in combination with both auto and manual dosing of detergent.
- Fisher & Paykel does not recommend the storing of laundry wash products containing acetic acid, eg vinegar, in 'Auto Dose' compartments.

Manual Dose

Where a detergent for a certain fabric and/or cycle is recommended, 'Manual Dose' is the default setting (eg Wool, Drum Clean). Refer to 'Wash Preparation - Adding detergent and softener' for more details on the right amount of detergent to use for 'Manual Dose'.

When 'Manual Dose' is selected ActiveIntelligence™ is not available.

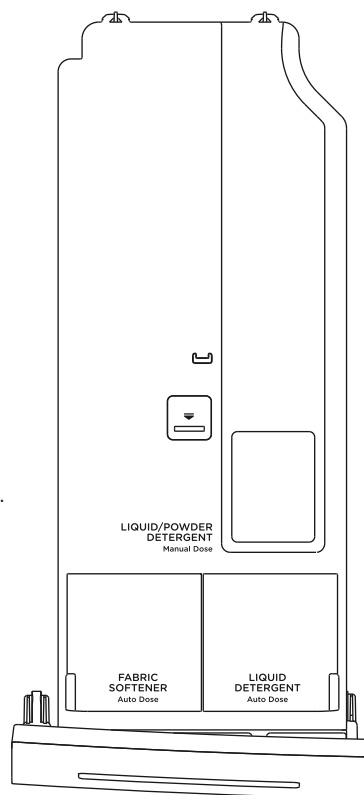

Dispenser drawer

WASH PREPARATION

Sorting your load

Sort items according to colour, fabric type, and soil type. Wash fine, delicate fabrics separately from thick, heavy fabrics. Always separate coloured items from whites, especially when they are new. Colour run could be an issue if you wash items at higher temperatures. Some soils, like mud and blood are best washed in cold water. Oily soils (eg some foods and marks on shirt collars) are best washed in warm water. The following are recommendations for what cycles and settings you may wish to wash different items on, and suggestions for special wash requirements.

ITEMS/WASH REQUIREMENTS	SUGGESTED CYCLE AND OPTIONS	SUGGESTED TEMPERATURE
Towels	Towels, 1400 or 1100 rpm spin	30°C or 40°C
Sheets, pillowcases	Everyday, 1400 or 1100 rpm spin	30°C or 40°C
Bulky items - doonas, duvets, sleeping bags	Bulky	30°C or 40°C
Shirts, pants, other creasables	Easy Iron, 800 rpm	30°C or 40°C
Woollens, silks	Wool, 500 rpm	30°C or 40°C
Delicates, fine fabrics	Delicate	30°C
Jeans	Everyday or Heavy	Cold or 30°C
Highly coloured items	Everyday	Cold or 30°C
Whites, cotton items	Cottons, 1400 or 1100 rpm spin	40°C or 60°C
Sensitive skin or extra rinsing requirements	Allergy with Rinse+, 1400 or 1100 rpm spin	40°C
Asthma/allergies	Allergy with Rinse+	60°C
Lightly soiled items	Quick 30 or 15	30°C
Muddy, sandy or linty items	Everyday with Pre Wash and Rinse+	Cold
Unpleasant odour	Drum Clean	90°C
Items made of blended fibres (eg polyester cotton)	Everyday	40°C
Sportswear	Sports	30°C

Before you load

- Check pockets for items that could damage your clothes or get caught in the washer.
- Close zippers, hooks and eyes, and other fastenings (ie fasten the opening of duvet/ doona covers) and remove loose bra wires. All these can damage both your washer and your clothes.
- Place delicate items, such as lingerie, in a mesh laundry bag before placing in the washer.
- Pre-treat any stains, taking care not to spray pre-treaters on your washer as they can cause damage to the plastic surfaces.

WASH PREPARATION

Loading

Your washer will be more efficient when washing larger loads, so try to collect enough items to loosely fill the drum when the items are dry. Refer to 'Wash cycle guide' for the recommended maximum load size of wash cycles.

Adding detergent and softener

Use low sudsing or front loader detergent. Only liquid detergent can be used for 'Auto Dose'. Liquid or powder detergent can be used for 'Manual Dose'. Ensure that detergent and softener are filled correctly into their respective compartments.

If using Auto Dose

- Fill the 'LIQUID DETERGENT' compartment up until the 'MAX' level (1100ml) indicated.
- Fill the 'FABRIC SOFTENER' compartment up until the 'MAX' level (540ml) indicated.
 - If softener is selected, the washer will automatically dispense the fabric softener during the rinse part of each cycle.

Adjusting Auto Detergent and Auto Softener dosage

Customise 'Auto Dose' amount using 'Auto Detergent' and/or 'Auto Softener' in the 'Options' menu. Scroll through to 'Auto Detergent' and touch ✓ button to confirm. Use the arrows to select 'Less' or 'More' detergent and softener than the default 'Regular' amount for your wash load.

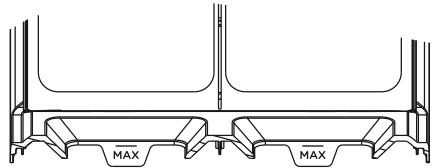

If using Manual Dose

- 'Manual Dose' can dispense powder or liquid detergent for washing.
- Follow the instructions stated on the detergent label as a guide when determining the correct dosage of detergent suitable for your wash load.
- The detergent dosage may vary depending on the amount of soil, size of the load and the water quality. Alter the dosage accordingly after each wash result.
- An overdose of detergent can cause oversudsing issues. Using too little causes residue buildup resulting in unpleasant odours and poor washer performance.
- **Do not overfill the detergent compartment. Too much detergent could result in water and detergent spilling onto the floor.**
- **Make sure that the dispenser is completely closed before starting the cycle. Do not open it again until the cycle is complete and the washer has stopped spinning.**

GETTING STARTED QUICKLY

- ① Load your clothes individually into the drum. Close the door. Refer to 'Safety features', page 14 for correct locking and unlocking of the door.
 - ② Press 'POWER' to turn on your washer.
 - ③ Select your wash cycle by turning the SmartTouch™ Control Dial.
 - A red LED will illuminate to match your selection.
 - The screen will display the information specific to the selected wash cycle.Refer to 'Wash cycles', page 17 for more details on options that suit your laundering needs. Refer to 'ActiveIntelligence™', page 19 for more information.
 - ④ Once the wash cycle is selected, the screen displays 'No Delay', indicating that wash is ready to start. Touch ✓ button to confirm.
 - If you prefer to start the wash cycle at a later time, set a delay for the start time of your washer. Refer to 'Delay Start', page 24 for more information.
 - ⑤ Select your desired detergent/softener dosing mode. Refer to 'Auto and manual dose', page 20 for more information.
 - ⑥ Fill the liquid detergent and fabric softener in their respective compartments. Refer to 'Wash Preparation - Adding detergent and softener' (page 22) for more information on the amount of detergent/softener to use.
 - ⑦ If you wish to adjust the default settings of the wash cycle, refer to 'Customising a wash cycle', page 24.
 - ⑧ Once ready, touch ►|| to start the cycle.
 - If you make an invalid selection, the washer will beep to alert you.
 - When the cycle finishes, your washer will perform end of cycle beeps and then turn off automatically.
 - If you wish to stop your washer at any point during a cycle, simply touch ►|| to pause the cycle. There may be a slight delay while the drum comes to a stop, then the door will unlock. Under certain conditions however the door will remain locked for safety reasons (refer to 'Safety features', page 14).
 - If you wish to cancel or change the wash cycle once a cycle has started, simply touch the ►|| button then select the new cycle. Touch ►|| to restart the washer.
- **For the best fabric and colour care, remove your clothes as soon as the cycle is complete.**
 - **Failure to follow the instructions in this guide can result in damage to your garments and expectations of wash performance may not be met.**

Delay Start

If you prefer to delay the start of your wash cycle, you can set a 'Delay Start' time from between 15 minutes and 12 hours. Delay times are 15 min, 30 min, 1 hour, then hourly up to 12 hours. This can be useful to time your washing to finish when you arrive home from work, or to start once you have finished in the shower. Some stain removers also require you to spray and leave the product on the stain for several minutes before washing. Your washer will wait for the selected time then start the cycle without any other input from you.

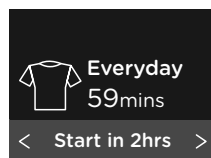

- ① To programme a 'Delay Start' time,
 - Press < or > button to scroll from 'No Delay' through various delay times. The delay time will increase from 15 minutes up to 12 hours.
 - Select your preferred delay time and touch ✓ to confirm.
- ② Once started, the time will count down on the display screen in 1 minute increments. Note: We suggest that you avoid using 'Delay Start' for damp, non-colourfast items as this may cause dye run to occur.

Favourite

After using your washer a few times you may discover there are some options you prefer for some cycles. You can programme your washer to remember the wash options you prefer for each cycle. There are two options for making a wash cycle 'Favourite'.

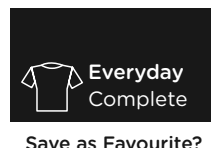

At the end of a cycle:

- ① The display will show the cycle used and the status as complete with the question 'Save as Favourite?'.
- ② To accept, touch ✓ button to accept.
- ③ The display will show the setting has been saved.
- ④ The cycle will now show ♥ icon to show cycle has been saved as a favourite.

From 'Options':

- ① Select the cycle using the control dial.
- ② Select start time ('No Delay' or 'Delayed Start' time of your choice).
- ③ Scroll through 'Options' using < or > and select 'Favourite'. Touch ✓ to edit.
- ⑤ Select 'Save', and touch ✓ to confirm.
- ⑥ The cycle will now show ♥ indicating the cycle has been saved as a favourite.

Note:

- Favourites can only be removed using 'Reset Default' in the settings menu.
- When 'Reset Default' is selected, all favourites saved for all cycles will be removed.
- If you adjust the default settings of the wash options (eg the dosage amount of detergent or an extra rinse), you can save it as a 'Favourite' to enable you to use it again for succeeding washes.
- 'Wool cycle' cannot be made a favourite.

CUSTOMISING A WASH CYCLE

Wash Temp

Your washer offers five wash temperatures:

Cold	30°C	40°C	60°C	90°C
------	------	------	------	------

- Simply touch the 'Wash Temp' button to increase or decrease the wash temperature.
- The washer will fill with both hot and cold water (if possible) to achieve the selected wash temperature. If required, ie for cold supply or cold connection only, the washer will heat the water to the selected temperature.
- Some temperatures are not available on some cycles as a safeguard for your clothes (eg 60°C or 90°C on the 'Delicate' cycle).

When 90°C temperature is selected, the door will become warm. Take care when touching the door. Keep children away from the washer.

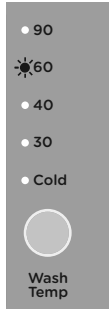

Spin Speed

- Your washer offers four spin speeds: 500 rpm, 800 rpm, 1100 rpm and 1400 rpm, plus an additional 'No Spin' option.
- Simply increase or decrease the spin speed by touching the 'Spin Speed' button.
- Selecting 'No Spin' will end the cycle after the rinse, allowing you to remove items you wish to drip dry.

Note: the washer will complete the spins that are within the wash and rinse portions of the cycle; only the final spin will not be completed. If you have removed the items you wish to drip dry and there are items remaining that you would like to spin, press 'POWER' and select the 'Spin' cycle. If necessary, modify the spin speed to best care for your load (ie spin delicate items at 500 rpm for best garment care).



Selecting Auto and Manual Dose

'Auto Dose' of detergent is activated by default for all wash cycles (except for 'Wool' and 'Drum Clean'). A red LED is illuminated to indicate your selected setting (Detergent, Softener, Manual) is activated. When 'Manual Dose' is selected, ActiveIntelligence™ is disabled.

- ① Touch 'Auto Dose' once to activate 'Detergent' + 'Softener'.
- ② Touch 'Auto Dose' again to activate 'Manual Dose'.
- ③ Touch 'Auto Dose' again to activate 'Manual Dose' + 'Softener'.



CUSTOMISING A WASH CYCLE

Wash cycle options

All wash cycles default to the recommended settings for that cycle based on the average expected load to be washed. You can adjust and customise the wash options to create your desired cycle.

'Everyday', 'Cottons', 'Heavy', 'Sports' and 'Delicate' cycles default to the ActiveIntelligence™ setting as indicated by the icon at the top right hand corner of the main display screen.

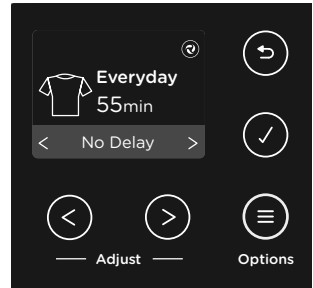

To change a wash cycle option:

- 1 Touch ≡ on the control panel. The screen will show the default option ActiveIntelligence™.
- 2 Touch < or > to scroll through other options.
- 3 Touch ✓ to select the option and enable editing.
- 4 Touch < or > to select the option and then touch ✓ to confirm.

To change an option or options you have selected after a cycle has started:

- Touch ▶|| and select your new setting through the options menu, then touch ▶|| again to resume the cycle with the new setting or settings.

Note: Some options may not be available for selection under certain conditions and after particular stages of the cycle have passed.

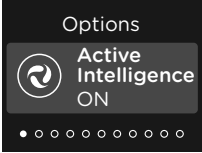
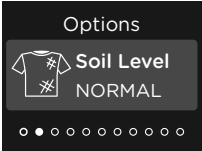
DESCRIPTION	OPTIONS
ActiveIntelligence™ <ul style="list-style-type: none">• Shown as the default first option in the main display screen for the five ActiveIntelligence™ cycles.• Options that are not available on ActiveIntelligence™ cycles are disabled and shown in grey.	ON (Default) OFF 
Soil Level <ul style="list-style-type: none">• 'Soil Level' enables you to adjust the wash to suit the amount of soil in your load (eg select 'Heavy' for dirty clothes; select 'Light' for items that are only lightly soiled).• Adjusts the wash time accordingly to give the load the right amount of agitation to remove the soil.• Set to 'Auto' on ActiveIntelligence™ cycles.	LIGHT NORMAL (Default) HEAVY 

CUSTOMISING A WASH CYCLE

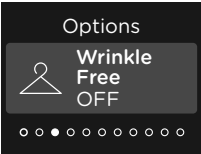
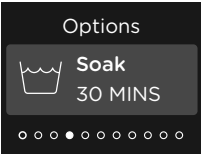
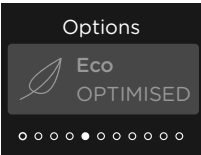
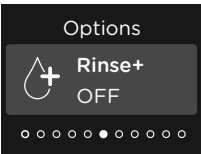
DESCRIPTION	OPTIONS	
<p>Wrinkle Free</p> <ul style="list-style-type: none"> We recommend to remove the clothes from the washer immediately after wash cycle is complete to reduce wrinkling and creasing of items and prevent dye run. Set 'Wrinkle Fee' only if you are going away before wash cycle ends. OFF is default for all wash cycles except for 'Easy Iron' cycle. 	<p>ON OFF (Default, except 'Easy Iron')</p>	
<p>Note: When 'Wrinkle Free' is activated, the washer will tumble the clothes once every 15 minutes for up to 12 hours after the cycle has finished. The main display screen will show an animation and beep at regular intervals to remind you to remove your load. To remove the load during this phase, simply touch the ►► button.</p>		
<p>Soak Time</p> <ul style="list-style-type: none"> The washer will add the selected sequence, which combines periods of tumbling with soaking to help lift stubborn stains. 'Soak' is not available on the 'Wool', 'Quick' and 'Drum Clean' cycles. 'Soak' is not available for ActiveIntelligence™ cycles. 	<p>OFF (Default) 30 mins 1 hour 2 hours</p>	
<p>Eco</p> <ul style="list-style-type: none"> Saves water and energy. Reduces wash temperature slightly and alters wash and rinse programming. 'Eco' is OPTIMISED by default for ActiveIntelligence™ cycles. 'Eco' must be selected before starting the cycle. 'Eco' is disabled once a wash cycle starts if not preselected. 	<p>ON OFF (Default) OPTIMISED (For ActiveIntelligence™ only)</p>	
<p>Rinse+</p> <ul style="list-style-type: none"> 'Rinse+' is not available if 'Eco' is ON. Use Rinse+ if you have a particularly dirty load, or you have sensitive skin and wish to give your clothes an extra rinse. Your load will undergo an extra rinse to get rid of any residual detergent or soil in the items. 'Rinse+' is always cold. 'Rinse+' is not available for ActiveIntelligence™ cycles. 	<p>ON OFF (Default)</p>	

CUSTOMISING A WASH CYCLE

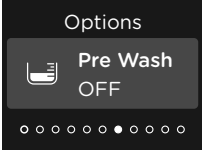
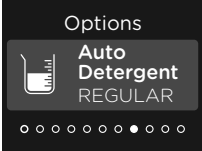
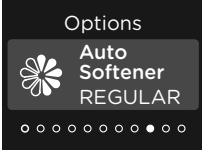







DESCRIPTION	OPTIONS	
<p>Pre Wash</p> <ul style="list-style-type: none"> For extra dirty loads, perform a 'Pre Wash'. Your washer will start the wash with a short wash in cool water to remove excess soil. After this, the washer will drain and then fill at the selected temperature for the main wash. Not available in ActiveIntelligence™ cycles. To use Pre Wash, turn ActiveIntelligence™ off. Available as an automatic option, but not for use in manual mode. 	<p>OFF (Default) AUTO</p>	 <p>The image shows a control panel with a dark background. At the top, the word 'Options' is displayed. Below it, there is a white icon of a washing machine. To the right of the icon, the text 'Pre Wash' is shown above 'OFF'. At the bottom of the panel, there is a row of ten small circles, with the fourth circle from the left being filled in white, indicating the current selection.</p>
<p>Auto Detergent</p> <ul style="list-style-type: none"> Enables user to modify the default amount of detergent preferred for auto dosing. Not available for 'Manual Dose' 	<p>LESS- LESS REGULAR (Default) MORE MORE+</p>	 <p>The image shows a control panel with a dark background. At the top, the word 'Options' is displayed. Below it, there is a white icon of a detergent dispenser. To the right of the icon, the text 'Auto Detergent' is shown above 'REGULAR'. At the bottom of the panel, there is a row of ten small circles, with the fourth circle from the left being filled in white, indicating the current selection.</p>
<p>Auto Softener</p> <p>Enables user to modify the default amount of softener preferred for auto dosing.</p>	<p>LESS- LESS REGULAR (Default) MORE MORE+</p>	 <p>The image shows a control panel with a dark background. At the top, the word 'Options' is displayed. Below it, there is a white icon of a softener dispenser. To the right of the icon, the text 'Auto Softener' is shown above 'REGULAR'. At the bottom of the panel, there is a row of ten small circles, with the fourth circle from the left being filled in white, indicating the current selection.</p>

CUSTOMISING A WASH CYCLE

Editing your Settings

'Settings' can be used to adjust default settings to user preferences for beeps, drum light, screen brightness, user prompts and factory reset.

To change a setting:



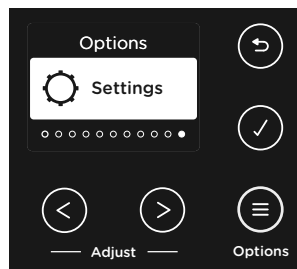



- 1 Touch  on the display panel.
- 2 Go to 'Settings', and then touch  to edit.
- 3 Touch  or  to scroll through the list of settings, and touch  to select and edit.
- 4 Touch  or  to select and  to confirm.



DESCRIPTION	SETTINGS
Cycle information Displays details of the maximum load capacity, suitable fabric types and cycle tips for the selected cycle.	ON (Default) OFF
Beeps Turns on/off the sound when touching the buttons. <ul style="list-style-type: none">• The sound when touching the buttons.• The series of beeps that sound at the end of a cycle to alert you that the washer has finished.	ON (Default) OFF
Screen Brightness Adjusts the brightness of the digital display screen.	LOW MEDIUM (Default) HIGH
Drum Light Turns on/off drum light. <ul style="list-style-type: none">• LED light turns on when the washer is powered and turns off automatically.• Turns on again at the end of the cycle to help facilitate unloading.	AUTO (Default) OFF
User Prompts Turns ON or OFF the user-prompts that are not related to warnings or faults.	ON (Default) OFF

Reset Defaults

You can reset your washer to the default settings it left the factory with:

- 1 From any cycle, touch the  button, select 'Settings' using the   buttons and then touch  to confirm.
- 2 Scroll through the 'Settings' using the   buttons to locate 'Reset Defaults', confirm by touching the  button.
- 3 Your washer will now be reset to factory default settings.

Selecting 'Reset Defaults' will reset all 'Favourites' and any other saved settings back to the factory default settings.

CARING FOR YOUR WASHER

When you have finished using your washer

- Unplug the washer from the power socket on the wall.
- Wipe around the door and in the rubber gasket to remove any remaining water and foreign matter.
- Turn off the taps to prevent the chance of flooding should a hose burst.

Cleaning your washer

Before you start cleaning your washer, ensure that it is disconnected from the power (ie unplug the washer from the power socket).

Cleaning the control panel and outer surfaces of the washer

Use a soft damp cloth to wipe all surfaces, then wipe dry. Avoid using chemical or scouring cleaners, as these will damage the paint and plastic surfaces of your washer.

Cleaning the dispenser drawer

If you need to clean the dispenser, follow the steps below:

- ① To remove the drawer from the washer, pull it open, push down on the release button to the left of the 'Manual Dose' compartment (refer to **A**), and pull it out from the washer.
 - When handling the dispenser, ensure to keep it horizontal to avoid spillage.
- ② To empty the dispenser, turn the dispenser upside down in the sink and allow the leftover laundry liquid from the 'Auto Dose' compartments to drain. To clean the dispenser, fill the compartments with warm water and shake lightly to clear residue. Drain all water from the compartments before re-fitting the dispenser to the washer.

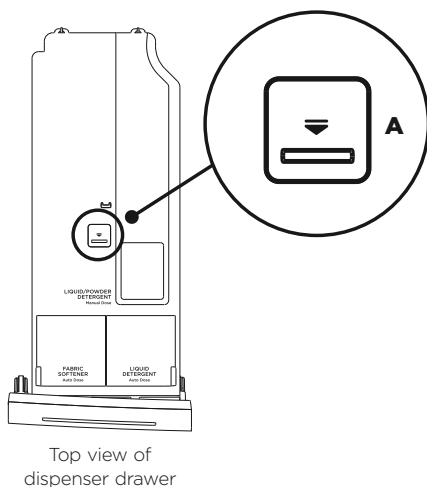

If a foreign object is inserted into the dispenser drawer compartments, the dispenser drawer cover can be removed (see above). Unhook the two clips at the rear of the dispenser to remove the cover. Ensure the dispenser drawer is correctly reassembled before re-fitting the dispenser to the washer. Any misassembly or damage to the parts could result in malfunction of the product.

Cleaning the inside of your washer

It is important that you regularly clean the inside of your washer using the 'Drum Clean' cycle. After 100 cycles, a notification will pop up on the display screen to remind you to clean your washer. Carry out an additional 'Drum Clean' cycle if your washer starts to smell. Remove any items from the washer before you run this cycle.

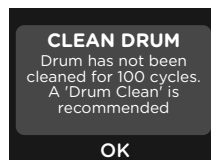

To clean the inside of your washer:

- ① We recommend the use of commercial washing machine cleaners only.
- ② Add the washing machine cleaner to the 'Manual Dose' detergent compartment when using 'Drum Clean' cycle.
- ③ Press 'POWER' to turn your washer on and select the 'Drum Clean' cycle.
- ④ Touch ►|| to start the cycle.

Cleaning the drum and the door

- Use a soft damp cloth to wipe the door, cleaning any water marks or residue off it.
- Wipe the rubber seal around the door. Remove any items or lint accumulating in the bottom of the seal catchment and wipe out any water accumulated here. If this is not cleaned out, unpleasant odours will develop.
- If the drum has any residual dirt or lint stuck to it, remove this and wipe the drum clean. Do not leave any metal objects in the drum as these may rust and cause staining.
- The WH1260F1 model has a self cleaning door flush that directs a portion of the rinse water over the door during various stages of the cycle to help to clean hair and insolubles from the inside of the door and surrounding parts. We still advise that you manually clean it with a soft cloth periodically as recommended in the instructions above.

Cleaning the pump filter

The pump has a filter to trap foreign objects that enter the washer along with clothing. The pump filter can be accessed from the front of the washer. The washer will notify you to check the filter every 100 cycles. If this is not addressed it will become a warning. (Refer to page 35)

To clean the filter:

- ① Unplug the washer from the power socket on the wall.
- ② Use a coin to open the filter cover. Place the edge of the coin into the slot and tilt upwards whilst levering the cover open.
- ③ Unhook the pump outlet hose and pull it out (about 150mm). Remove the plug and allow any water (approximately 250ml) to drain into a shallow dish.
- ④ After the draining process is complete, replace the plug into the hose and refit the hose back into the housing.
- ⑤ Remove the filter by turning anti-clockwise (refer to **A**). Clean and rinse under a tap. Check the pump filter cavity for any further obstruction.
- ⑥ Replace the filter by turning clockwise until the turning handle stops in the vertical position, and cannot be turned further (refer to **A**).
- ⑦ Close the filter cover.

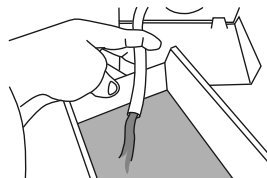

Drain residual water

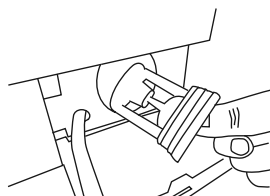

Removing/replacing filter

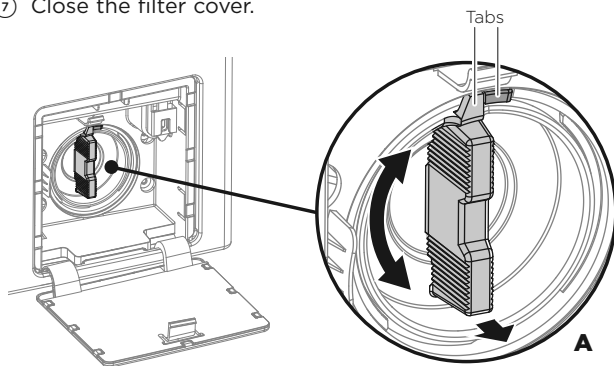

A Turn filter clockwise until turning handle stops in vertical position and tabs meet

Cleaning the hoses

Each inlet hose has a filter in it, preventing any solid contaminants in the water from entering your washing machine. Occasionally you should disconnect the water inlet hoses where they connect to the taps, check these for any build up of dirt and wash the filters out.

Nappy sanitisers/bleach

Nappy sanitisers and bleach are very corrosive to metal surfaces. DO NOT tip the contents of a nappy bucket into your washer. Rinse and wring items out thoroughly before placing them in the washer.

- **Leave the door to your washer open when it is not in use to allow the washer to dry out, otherwise it will develop unpleasant odours. When leaving the door open like this, it is extremely important that children and pets are kept away from the washer so they cannot be accidentally trapped inside it.**
- **Aside from the detergent dispenser, water hoses, and the pump filter, no other parts are designed to be removed from the washer for cleaning. Do not attempt to remove any other part of the washing machine.**

Detergent advice

- If unpleasant odours are noticeable from your washer, it is possible that not enough detergent is being used for the soil level in your loads. Run a 'Drum Clean' cycle and either buy a better quality detergent or use a higher dose. If you are using an 'Eco' detergent, alternate the use of this with a mainstream detergent.
- Add detergent BEFORE starting the cycle, close the dispenser and do not open it while the cycle is running.
- If you find foam leaking from your washer, check if you are using a low sudsing or front loader type detergent. When using 'Manual Dose', check the quantity you are using against the manufacturer's recommended dose on the label. You may need to reduce the amount you are using.
- If using 'Auto Dose' you may need to reduce the amount used. Refer to 'Auto Detergent' in the Options menu (refer to page 28) to adjust the dosage.

Fabric softener advice

- Clean your dispenser regularly.
- Clean your washer regularly using the 'Drum Clean' cycle.
- Complete wash cycles at a wash temperature of 40°C or above at regular intervals (eg every 5th wash) as washing in cold water increases the chance of scrud occurring (see below).

Scrud is the name of the waxy build-up that can occur within any washer when fabric softener comes in contact with detergent. This build-up is not brought about by a fault in the washing machine. If scrud is allowed to build up in the washer it can result in stains on clothes and an unpleasant smell in your washer.

If a particularly dirty load needs to be washed, we recommend putting the washer through a 'Rinse' cycle once the entire cycle has finished and the load has been removed. This will help clean out any residue from that cycle.

BEFORE YOU CALL FOR SERVICE

User warnings

Your washer is capable of self diagnosis and may sound a series of beeps and display a notification or warning to inform you when there is a problem. In most cases you will be able to address the problem the washer is alerting you to. Check this chart before you call for service.

NOTIFICATION	WHAT TO DO
DOOR OPEN	Close the door properly. Touch ✓ to confirm, and then touch ► to resume wash. Try opening and closing the door again.
CLEAN DRUM	Clean the drum. Select the 'Drum Clean' cycle and touch 'START/PAUSE'. The reminder will display after every cycle, until the cycle is performed.
OUT OF BALANCE	Touch ► to retry the spin. If the warning persists, pause the cycle, manually redistribute the load and touch ► to spin again. If necessary, stop the cycle, select 'Spin' and touch ► . If the problem persists, check that the washer is correctly levelled.
OVER-SUDSING	Wait for the washer to automatically restart when suds have dissipated. When oversudsing occurs you may notice a reduction in performance. Check you are using a detergent suitable for front loaders. Check you are not overdosing the detergent. Check the drain hose height does not exceed 1000mm.
DOOR IS LOCKED	The temperature in the drum is over 60°C therefore it is not safe to open the door. Wait until the temperature drops below 60°C. Check the water level in the drum. If the level is above the bottom of the door seal, the door cannot be opened. Use the 'Add a Garment' button if you wish to add or remove items. If the drum is still moving, wait for it to stop before attempting to open the door.
KEYLOCK ON	To disable, touch and hold the 'Keylock' button for 3 seconds.
DETERGENT LEVEL LOW	Refill 'Auto Detergent' compartment or switch to 'Manual Dose'. Take care to not fill beyond the MAX mark.
SOFTENER LEVEL LOW	Refill 'Auto Softener' compartment. Take care to not fill beyond the MAX mark.
CLEAN FILTER	The pump filter is blocked and needs to be cleaned. Follow instructions on the label and refer to page 32 of this guide.
HIGH TEMP	Door may remain locked due to high temperature in drum. Wait for temp to reduce then try again.
WATER LEVEL	Water level is too high. If this occurs, disconnect power and water and contact Fisher & Paykel Customer Care.
NO WATER	Check taps have been properly connected and are turned on.
ADD A GARMENT	Wait for the door to unlock. The washer may need to lower its water level and/or wait for a safer drum temperature before unlocking.

FAULT CODES

If a continuous series of beeps sounds, all the lights turn off on the control panel and a number appears on the display, a fault has occurred. The washer automatically enters this mode when there is a fault. The word 'Fault' will be shown in the control panel display followed by a number (refer to example shown here). To stop the beeps, touch any button then perform the following steps:



Fault code screen

- ① Turn your washer off at the power point on the wall.
- ② Wait one minute and turn it back on.
- ③ Check that your washer is installed correctly (refer to 'Installation instructions' pages 5-12).
- ④ Remove your wash load.
- ⑤ Perform a 'Rinse' cycle.
- ⑥ If the fault re-occurs repeat steps ① and ②.
- ⑦ If the washer still displays a fault code, go online or call a Fisher & Paykel trained and supported service technician to arrange service (refer to 'Customer care' page 44).
- ⑧ Record the fault code number displayed and the serial number of your washer (located on the rear of the washer, and/or above the drum opening when the door is open) before calling. The fault code will indicate to the service technician what the problem could potentially be.

If a fault code is being displayed (as shown above), you can still turn your washer off by pressing 'POWER'.

TROUBLESHOOTING

The following is a list of problems you may encounter when using this appliance and some suggestions that may help to correct the problem. If you still have problems, please contact your Fisher & Paykel trained and supported service technician.

Solving operating problems

PROBLEM	POSSIBLE CAUSES	WHAT TO DO
Washer not turning on	Power not switched on at the wall.	Switch the power on at the wall. Then press 'POWER'.
	Household power supply not working.	Try plugging in another electrical appliance.
	Keylock may be activated.	Touch and hold the 'Keylock' button for 3 seconds (refer to 'Keylock', page 16).
Touching ►II does not start the fill	Washer door not closed properly.	Open and reclose door.
	The washer is waiting for a command from you.	If ►II is flashing then the washer is waiting for a command from you.
	The washer has detected a fault.	Check if a code is being displayed on the panel (refer to 'Fault codes', page 35).
	Hot and cold taps not turned on.	Check that both hot and cold taps are turned on (if using cold inlet only ensure inlet valve cap is installed on the hot valve on the washer).
	Hot and cold taps not connected to the corresponding valve on the washer.	Check the cold tap is connected to the cold valve on the washer and the hot tap is connected to the hot valve.
	Blocked hose filters.	Check the tap end of the inlet hoses for blockages.
	Inlet hose leaking, twisted or damaged.	Check the inlet hoses for leaks or damage. Check that the inlet hoses are not twisted.
	Faulty water supply.	Check taps that aren't connected to the washer are working.
	Delay start may be set.	Refer to 'Delay Start', page 24.
	Washer stops working mid cycle	The washer has detected a fault.
Power or water failure.		Check the power and/or water is working correctly.
Washer has been paused.		Touch the ►II button to continue.
Oversudsing.		Washer is waiting for suds to dissolve before continuing the cycle.

TROUBLESHOOTING

PROBLEM	POSSIBLE CAUSES	WHAT TO DO
Washer drains while filling	Drain hose too low.	The height of the drain hose in stand pipe, tub or spigot must be at least 600mm from the floor level (refer to 'Draining', page 10).
	Drain hose sitting in water.	Clear the drain.
Washer is not draining	Drain hose blocked.	Clear the drain hose.
	Pump filter blocked.	Clear the pump filter (refer to 'Cleaning the pump filter', page 32).
	Drain hose higher than 1000mm above floor level.	Lower the level of the drain hose (refer to 'Draining', page 10).
Filling continuously	Drain hose not connected to standpipe or tub.	Connect drain hose correctly (refer to 'Draining', page 10).
	Washer siphoning.	Ensure standpipe or tub is at least 600mm from the floor level.
Poor rinsing	Incorrect detergent used.	Use low sudsing, front loader detergent only (refer to 'Adding detergent and softener', page 22).
	Too much detergent used.	If adding detergent in the manual dispenser, ensure the correct dose of detergent is used for the load size and soil level. If using 'Auto Dose', reduce the dosage by using 'Auto Detergent' (refer to 'Customising a wash cycle', page 28).
Not spinning properly	Load has gone out of balance.	Open door and redistribute load, then restart the washer.
	Washer is not level.	Ensure washer is correctly levelled (refer to 'Levelling the washer', page 8).
	Suds build up.	Check the amount of detergent used, reduce if necessary.
Too many soap suds	Incorrect type of detergent used.	Use low sudsing, front loader detergent only (refer to 'Adding detergent and softener', page 22).
	Too much detergent used.	If adding detergent in the manual dispenser, ensure the correct dose of detergent is used for the load size and soil level. If using 'Auto Dose', reduce the dosage by using 'Auto Detergent' (refer to 'Customising a wash cycle', page 28).
	Inlet water pressure/flow rate too low	Ensure correct inlet water pressure and flow rate as per installation instructions.

TROUBLESHOOTING

PROBLEM	POSSIBLE CAUSES	WHAT TO DO
Small puddle of water from under the washer	Inlet hose or drain hose leaking.	Check inlet hoses and the drain hose are correctly attached and not damaged.
	Lots of suds.	Suds may have leaked and then dissolved.
	Dispenser compartments blocked.	Clean dispenser drawer (refer to 'Cleaning the dispenser drawer', page 30).
	Dispenser drawer not fully closed.	Close dispenser drawer fully and ensure it remains closed during the cycle.
Cycle time longer than usual/ Inaccurate time reading/ Adjustment of time remaining during cycle	Wash time is approximate.	Wash time may be influenced by a number of factors such as water flow rate, water pressure, hot tap connection or reliance on internal heater, load size, cycle and option selections, as well as issues such as oversudsing and out of balance.
	Low water pressure or flow rate.	Ensure that inlet hose filters are not blocked.
	Out of balance or oversudsing.	Recovery from out of balance or oversudsing will extend cycle time (refer to 'User warnings', page 34).
	Washing a large load.	Be aware that it will take longer for the washer to fill.
Detergent remaining in manual dispenser at the end of the cycle	Selecting various options.	Be aware that some options will extend cycle time, eg 'Soak', 'Rinse+'.
	Dispenser drawer not properly closed or was opened part way through the cycle.	Ensure the dispenser drawer is fully closed at the start of the cycle and remains closed throughout the cycle.
	Dirty or blocked dispenser.	Clean the manual dispenser compartment.
	Dispenser overloaded with detergent.	Clean out remaining detergent (refer to 'Adding detergent and softener', page 22 for dosing information). Do not fill above the MAX level.
	Composition of the detergent makes it difficult to dispense.	Clean the manual dispenser compartment.

TROUBLESHOOTING

PROBLEM	POSSIBLE CAUSES	WHAT TO DO
Washing very wet at the end of the cycle	Cycle selected is not appropriate for load.	Particularly short or delicate cycles have shorter spins which can result in wetter washing at the end of the cycle.
	Incorrect spin speed for load selected.	Select a faster spin speed.
	An out of balance load has occurred.	The washer compensates for being out of balance by using a lower spin speed, to reduce noise and potential damage to itself.
Vibrating	Transit bolts left in place.	Ensure transit bolts are removed prior to use of the washer (refer to 'Removing transit safety bolts', page 5 and 6).
	Washer may not be level.	Ensure washer is installed on an appropriate surface and levelled correctly (refer to 'Levelling the washer', page 8).
	Load is out of balance.	Wash an average sized load rather than a smaller load or a single item. Washing one item at a time is not recommended as it is difficult for the washer to balance a single item during spin.
Creasing	Washer overloaded.	Do not overload washer.
	Incorrect cycle for load type.	Use the 'Easy Iron' cycle for creasable items.
	Spin speed too fast.	Select a slower spin speed.
	Wet clothes left in washer or laundry basket.	Laundry left sitting wet is more likely to crease. If not removing clothes from washer immediately at end of cycle, select the 'Soil Level' option. Do not leave wet washing sitting in a washing basket.
	Wash temperature too hot for load type.	Select a lower wash temperature. Check items care label for correct care. Check the hot and cold taps are connected to the right valves (refer to 'Connecting to the water supply', page 8).
	Items not sorted correctly.	Sort load so that items of similar weight are washed together (refer to 'Sorting your load', page 21).

TROUBLESHOOTING

PROBLEM	POSSIBLE CAUSES	WHAT TO DO
Poor soil removal	Incorrect wash cycle selected.	Select a wash cycle with options appropriate to the load (refer to 'Wash cycle options', page 26).
	Insufficient detergent.	If using the 'Manual Dose' dispenser, ensure the correct dose of detergent is used for the load size and soil level. If using 'Auto Dose', adjust the dose using 'Auto Detergent' (refer to 'Customising a wash cycle', page 28).
	Washer overloaded.	Ensure the washer is not overloaded in terms of its capacity or the cycle selected (refer to 'Loading', page 22).
	Items require a longer wash time.	Select a higher soil level option if available.
	Load was particularly dirty.	Select 'Pre Wash' option, where available, for particularly dirty loads (refer to 'Customising a wash cycle' and 'Pre Wash', page 28).
	Items not sorted correctly.	Wash heavily and lightly soiled garments separately.
	Washer dirty from previous wash.	After washing particularly dirty clothing we recommend putting the washer through a 'Rinse' cycle, once the load has been removed. This will wash away any remnants of dirt that could affect future wash performance.
	Incorrect wash temperature selected for the type of soil.	Select a wash temperature suitable for the type of soil, eg warm for greasy soils, cold for muddy soils. Increasing the wash temperature generally improves soil removal and overall wash performance. Ensure garments can be safely washed at the increased temperature.
Dye transfer	Coloured items not washed separately from white/light coloured items.	Remember to separate whites and colours.
	New or non-colourfast items not washed separately.	Wash non-colourfast items separately and select 'Cold' wash temperature.
	Wet items have been left sitting for too long.	Remove items from washer as soon as the cycle is finished, or if items are not to be removed from the washer immediately select 'Soil Level'.
	Wash temperature.	Consider the wash temperature you select for your coloured items. Lower the temperature if you are concerned.

TROUBLESHOOTING

PROBLEM	POSSIBLE CAUSES	WHAT TO DO
Black or grey marks on clothes	Incorrect amount of detergent.	If using the manual dispenser, ensure the correct dose of detergent is used for the load size and soil level. If using Auto Dose, adjust the dosage by using 'Auto Detergent' (refer to 'Customising a wash cycle', page 28).
	Washer needs to be cleaned.	Empty the washer and complete a 'Drum Clean' cycle (refer to 'Cleaning the drum and the door', page 31).
Tangling	Items not sorted correctly.	Separate larger items from smaller items.
	Washer loaded incorrectly.	Load items loosely and individually into the washer (ie not folded).
	Incorrect cycle for load type selected.	Use the 'Easy Iron' cycle to wash shirts.
	Washer overloaded in terms of its capacity or the cycle selected.	Try washing average to smaller load sizes.
	Delicate items.	Wash pantyhose, bras and any other delicate items prone to tangling in a mesh laundry bag.

Contact a Fisher & Paykel trained and supported service technician if a problem persists.

MANUFACTURER'S WARRANTY

For New Zealand and Australia only. You automatically receive a two-year Manufacturer's Warranty with the purchase of this clothes washer covering parts and labour for servicing within the country of purchase.

Fisher & Paykel undertakes to:

Repair or, at its option, replace without cost to the owner either for material or labour any part of the product, the serial number of which appears on the product, which is found to be defective within two years of the date of purchase.

You also receive an additional eight-year parts only Manufacturer's Warranty on your Direct Drive motor. This additional eight-year Manufacturer's Warranty commences on the day following the expiry of the two-year Manufacturer's Warranty and excludes the motor controller and labour. Fisher & Paykel will repair (as to parts) or, at its option, replace any Direct Drive motor (but not the motor controller) which is found to be defective within this additional Manufacturer's Warranty period. You will be responsible for any labour costs.

Note: These Manufacturer's Warranties are an extra benefit and do not affect your legal rights.

These Manufacturer's Warranties DO NOT cover

- Ⓐ Service calls which are not related to any defect in the product. The cost of a service call will be charged if the problem is not found to be a product fault. For example:
 - ① Correcting the installation, eg removal of bottom packer and transit bolts (front loading washers), levelling the washer, adjustment of the drain to correct siphoning, noises, crossed, kinked or leaking inlet hose connections, turning on water, noises caused by the waterhammer or power supplies.
 - ② Providing instruction on use of the product or changing the set-up of the product, eg instruction on correct use of detergents and fabric softeners.
 - ③ Replacing fuses in, or correcting house wiring or correcting house plumbing, eg unblocking drains.
 - ④ Correcting fault(s) caused by the user.
 - ⑤ Noise or vibration that is considered normal, eg spin sounds, user warning beeps.
 - ⑥ Correcting damage caused by pests, eg rats, cockroaches, etc.
 - ⑦ Water on the floor due to incorrect loading or excessive suds.
 - ⑧ Blocked pumps, removal of foreign objects/substances from the washer, including the pump and inlet hose filters, eg bra wires, bread tags, nails, grit, crud, etc.
 - ⑨ Correcting corrosion or discolouration due to chemical attack.
- Ⓑ Defects caused by factors other than:
 - ① Normal domestic use; or
 - ② Use in accordance with the product's User guide.
- Ⓒ Defects to the product caused by accident, neglect, misuse or 'act of God'.
- Ⓓ The cost of repairs carried out other than by a Fisher & Paykel trained and supported service technician or the cost of correcting such repairs.

MANUFACTURER'S WARRANTY

- Ⓔ Normal recommended maintenance as set out in the product's User guide.
- Ⓕ Repairs when the appliance has been dismantled, repaired or serviced by other than a Fisher & Paykel trained and supported service technician or the selling dealer.
- Ⓖ Pick-up and delivery.
- Ⓗ Transportation or travelling costs involved in the repair when the product is installed outside the Fisher & Paykel trained and supported service technician's normal service area.

Nothing in this Manufacturer's Warranty is intended to, nor limits, any rights you may have under law to recover the costs of inspecting or returning the goods to us.

This product has been designed for use in a normal domestic (residential) environment. This product is not designed for any commercial use (whatsoever). Any commercial use by a customer will affect this product's Manufacturer's Warranty.

Service under these Manufacturer's Warranties must be provided by a Fisher & Paykel trained and supported service technician (refer to 'Customer care', page 44). Such service shall be provided during normal business hours. This Manufacturer's Warranty certificate should be shown when making any claim.

For Australian customers

This Manufacturer's Warranty is an extra benefit and does not affect your legal rights. Our goods come with guarantees that cannot be excluded under the Australian Consumer Law. You are entitled to a replacement or refund for a major failure and compensation for any other reasonably foreseeable loss or damage. You are also entitled to have the goods repaired or replaced if the goods fail to be of acceptable quality and the failure does not amount to a major failure.

Keep this User guide in a safe place.

CUSTOMER CARE

Before you call for service or assistance:

Check our website, fisherpaykel.com, for 'Product Help' to see the latest updates, hints and tips, and information about your product.

We recommend that you also refer to your User guide to ensure:

- ① Your product is correctly installed.
- ② You are familiar with its normal operation.
- ③ You have read the 'Before you call for service', 'Fault codes' and 'Troubleshooting' at the back of the book.

If after checking these points you still need assistance or parts, you can go online to our website and book a service with your nearest Fisher & Paykel trained and supported service technician. Our Customer Care team is also available to offer you assistance.

In New Zealand if you need service or assistance:

Go online to our website and book a service or call the Fisher & Paykel Customer Care Centre and talk to one of our Customer Care Consultants.

Toll Free: 0800 FP CARE or 0800 372 273

Email: customer.care@fisherpaykel.com

Website: fisherpaykel.com

Postal address: Fisher & Paykel Appliances Ltd, PO Box 58550, Botany, Auckland 2163

Fisher & Paykel has a network of Fisher & Paykel trained and supported service technicians who can carry out any service necessary on your appliance. Visit our website and book a service with a Fisher & Paykel trained and supported service technician in your area.

In Australia if you need service or assistance:

Go online to our website and book a service or call the Fisher & Paykel Customer Care Centre and talk to one of our Customer Care Consultants.

Toll Free: 1300 650 590

Email: customer.care@fisherpaykel.com

Website: fisherpaykel.com

Postal address: Fisher & Paykel Appliances Australia Pty Ltd, PO Box 798, Cleveland QLD 4163

Fisher & Paykel has a network of Fisher & Paykel trained and supported service technicians who can carry out any service necessary on your appliance. Visit our website and book a service with a Fisher & Paykel trained and supported service technician in your area.

If you call, write to or contact us via our website, please provide your name and address, model number, serial number, date of purchase and a complete description of the problem. This information is needed in order to better respond to your request for assistance.

Product details can be found on the rear of the washing machine, and/or above the drum opening (when the door is open).

CUSTOMER CARE

Registration

Register your product with us so we can provide you with the best service possible.
To register your product visit our website: fisherpaykel.com

Complete and keep for safe reference:

Model _____

Serial No. _____

Purchase Date _____

Purchaser _____

Dealer _____

Suburb _____

Town _____

Country _____

FISHERPAYKEL.COM

© Fisher & Paykel Appliances 2019. All rights reserved.

The product specifications in this document apply to the specific products and models described at the date of issue. Under our policy of continuous product improvement, these specifications may change at any time. You should therefore check with your Dealer to ensure this document correctly describes the product currently available.

NZ AU

430151C 09.19