

**FISHER & PAYKEL**

**WASHSMART™ AND QUICKSMART™  
CLOTHES WASHERS**

---

**WA60T56G, WA55T56G, MW60, MW513,  
WA8056G & WA8056M models**

**INSTALLATION GUIDE / USER GUIDE  
NZ AU SG ROW**



## CONTENTS

---

Safety and warnings	4
Installation instructions	6
Before your first wash	12
Safety features	13
Control panel	14
Wash cycles	16
Wash preparation	18
Getting started quickly	22
Wash options	25
Favourite cycle	30
Customising wash cycles	32
Changing pre-set options	34
Caring for your washer	40
Before you call for service	43
Fault codes	45
Troubleshooting	46
Manufacturer's warranty	50
Customer care	52

---

### Registration

To register your product visit our website: [fisherpaykel.com/register](https://fisherpaykel.com/register)

### **⚠ WARNING!**



#### **Electrical Shock Hazard**

**Failure to follow this advice may result in electrical shock or death.**

- If you are using an extension cord or a portable electrical outlet device (eg multi-socket outlet box), ensure that it is positioned so that it does not come into contact with water or moisture.

## **READ AND SAVE THIS GUIDE**

**When using your clothes washer, follow basic precautions, including the following:**

### **General**

- This product has been designed for personal, family or household use. This product is not designed for any commercial use. Any commercial use will terminate this products manufacturer's warranty.
- A damaged power cord must be replaced by a Fisher & Paykel trained and supported service technician or similarly qualified person in order to avoid a hazard. Do not use the appliance until it has been repaired to avoid a risk of electric shock.
- Do not operate this machine if it has been damaged during transport. Contact your Fisher & Paykel dealer or Fisher & Paykel trained and supported service technician.
- This clothes washer is not intended for use by persons (including children) with reduced physical, sensory or mental capabilities, or lack of experience and knowledge, unless they are supervised or given instructions on how to use the washer by someone responsible for their safety.
- Keep children away from the washer while it is in operation.
- Supervise children to ensure they do not play with the washer or climb inside the drum.
- The washer should only be used for washing and rinsing of textiles where this is indicated on the care label.
- Do not add petrol, dry-cleaning solvents, or other flammable or explosive substances to the wash water. These substances give off vapours that could ignite or explode.
- Do not wash articles that have been previously cleaned in, washed in, soaked in, or spotted with gasoline, dry-cleaning solvents, or other flammable or explosive substances as they give off vapours that could ignite or explode.
- The lid will be locked for some parts of the wash cycle for safety reasons. It is possible to open the lid during the cycle under certain conditions. Never force the lid open.
- Do not touch or operate the machine with wet hands or with bare-feet.
- Ensure the installation provides accessibility to the plug or incorporate a switch in the fixed wiring in accordance with the wiring rules to allow disconnection of the appliance from the supply after installation.
- Read and follow the detergent manufacturers' instructions carefully. Instructions on how to use the detergent will be clearly indicated on the pack. Remember to store your detergents out of the reach of children.

## SAFETY AND WARNINGS

MODEL CODE	MAX CAPACITY* (KG)
WA55T56G	5.5
WA60T56G	6
WA8056G	8
WA8056M	8
MW60	6
MW513	5.5

\*Capacity refers to the maximum dry weight of items the washer can wash at any one time. The WA8056M and WA8056G models have a different capacity based on country standards. Refer to the serial plate on the back of the product.

- Do not overload your washing machine beyond its rated capacity.
- Do not wash an electric blanket in your washer unless the care label specifically states it is safe to do so.
- Do not wash curtains in this washer, as sunlight makes them brittle and they may disintegrate during washing.
- The only user-removable parts of the washer are the inlet hose(s) and dispenser. No other parts are designed to be removed by anyone other than a Fisher & Paykel trained and supported service technician.

### Installation

- For guidance on how to install your product, please refer to installation instructions contained in this document.

### Water supply requirements:

- Inlet water pressure: Max. 1MPa (145psi), Min. 34kPa (5psi)
- Inlet water flow rate: Min. 8 litres/minute
- A pressure-reducing valve must be installed if pressure is higher than 1MPa.
- For optimum wash performance check the supply pressure is within the recommended range.
- New hose sets provided with the washer should be used to connect the washer to the water mains. Old hose sets should not be re-used.
- We recommend the inlet hose(s) are changed every 5 years. WARNING: Failure to do so may result in a flood and damage to property.
- The hot water temperature should not exceed 65°C and the cold water temperature not exceed 35°C. Temperatures above these may cause the machine to fault or cause damage to the machine.
- Install the machine on a solid and level floor surface ensuring it has at least 20 mm clearance on each side. The washer must not be installed on any textured floor coverings (eg carpet, rugs).

### Disposal

- When disposing of the washer, it is recommended that the lid is removed to avoid children getting trapped inside, and that the electrical cable is cut off close to the washer.

# INSTALLATION INSTRUCTIONS

## Accessories

Check if you received the following accessories with your Fisher & Paykel washer. You will find them inside the drum or attached to the packaging.

- 1 x hose guide
- 2 x inlet hoses

## Unpacking

To ensure the best performance from your new washer please follow the instructions below.

### Removing the packaging

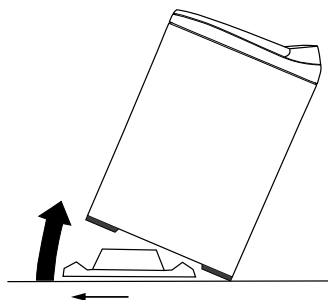

- ① Remove the outer packaging.
- ② Tilt the washer backwards and walk it off the base packer one foot at a time (ensure the lid is still taped down).
- ③ Remove the base packer from under the washer by tilting the washer backwards and pulling the packer out the front.
- ④ Remove the tape, lift the lid and remove the bowl packer from the bowl.
- ⑤ Remove the hoses and accessories.
- ⑥ Keep the base packer and bowl packer in case they are required for future transit.

**Ensure that the base packer has been removed before operating your washer.**

# INSTALLATION INSTRUCTIONS

## Product and minimum clearance dimensions

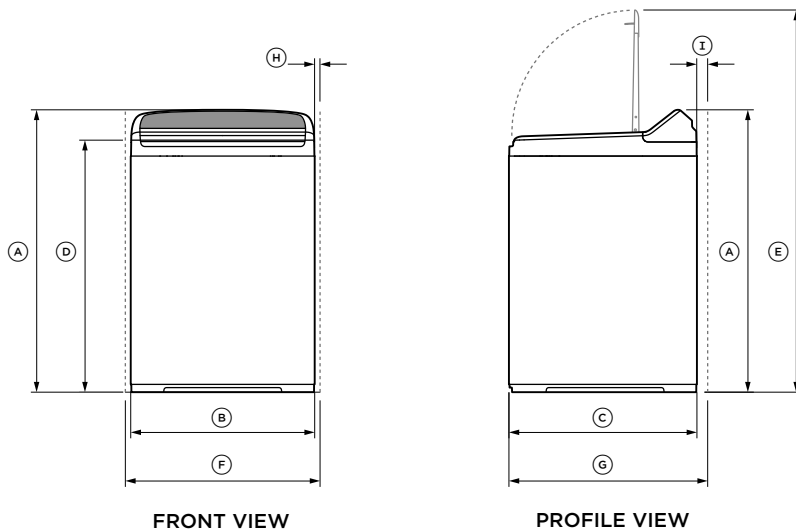

<b>PRODUCT DIMENSIONS</b>	<b>MM</b>
Ⓐ Overall height of product † (to highest point of console)	1020-1050
Ⓑ Overall width of product	560
Ⓒ Overall depth of product	560
Ⓓ Height of product to top of lid closed*	920-980
Ⓔ Height of product to top of lid open *	1320-1350
Standpipe height	850-1200
<b>MINIMUM CLEARANCES</b>	<b>MM</b>
Ⓕ Minimum cavity width	600
Ⓖ Minimum depth clearance (including inlet and drain hoses)	620
Ⓗ Minimum clearance to either side, wall or adjacent product	20
Ⓘ Minimum clearance at the rear of the product	50

\*The exact height of your washer is dependent on how far the feet are extended from the base of the washer.

#Applies either side.

# INSTALLATION INSTRUCTIONS

## Levelling instructions

It is **IMPORTANT** to level the washer to ensure good spin performance.

After levelling, the corners of the washer should be clear of the floor and the washer must not rock in any direction.

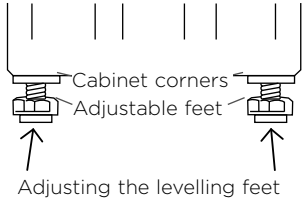

### Levelling your washer

- ① Move the washer to its final position.
- ② Adjust all four feet (wind down) so the washer is level and does not rock.

### To check if your washer is level:

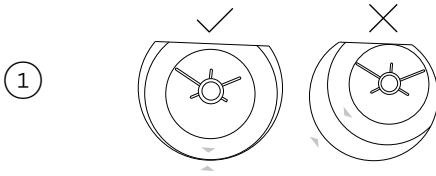

Look down on the wash bowl and make sure it sits slightly forward of centre

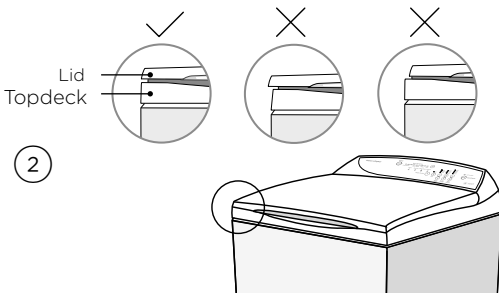

Close the lid.

Visually check that the lid fits evenly on both sides. If it does not look like the image in the middle, adjust one of the feet slightly.



# INSTALLATION INSTRUCTIONS

## Water supply

### Inlet hoses

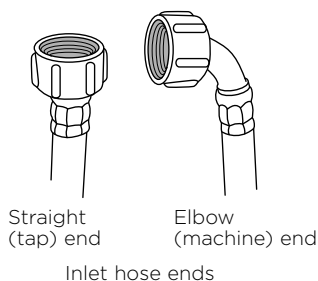

- ① Connect the straight ends of the inlet hoses to the taps (there are washers fitted in both ends). Connect the red connector hose to Hot, and the white connector hose to Cold.
- ② Connect the elbow ends of the inlet hoses to the corresponding washer inlet valves. Inlet valves are marked on the back of the washer. Ensure the Hot valve is connected to the hot tap and the Cold valve is connected to the cold tap.

H = Hot C = Cold

**Only use the new hose set provided with your washer.**

### Water supply requirements:

- If you have an uncontrolled water heating source (eg a wet back or solar heating system) you should fit a tempering valve. This will ensure the hot water temperature remains within safe limits. Contact your registered plumber to select and install the tempering valve.
- Your cold water should not exceed 35°C and your hot water should not exceed 65°C. Temperatures above these may cause the machine to fault or cause damage to the machine.
- Inlet water static pressure: Max. 1MPa (145psi) Min. 34KPa (5psi).
- Inlet water flow rate at tap: Min. 8 litres/min.

### Cold water supply only:

If you only have a cold water supply, a blanking cap **MUST** be connected to the Hot inlet valve. The cap prevents water leaking out of the hot valve. The cap is available from your Fisher & Paykel dealer or Fisher & Paykel trained and supported service technician, Part No. 388491P. This appliance incorporates backflow protection complying with AS3500.1. No further backflow protection is required for connection to the water supply.

Note: Your washer does not have an internal heater to heat water.

Should you wish to use cold water only for all wash cycles, refer to 'Customising wash cycles' on how to program your washer to remember your wash preferences.

# INSTALLATION INSTRUCTIONS

## Draining

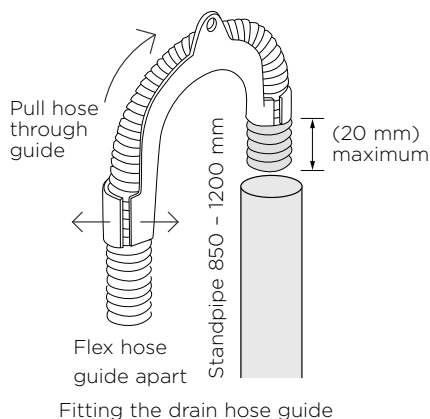

### Placing the drain hose in a standpipe or tub:

- ① Carefully pull the drain hose out from the back of the washer by pulling the exposed part of the hose downward and outward.
- ② To guide the drain hose over the tub or standpipe the hose guide **MUST** be fitted to the drain hose.
- ③ Place the drain hose in the tub or standpipe. Do not fit the hose to a drain spigot. Drainage must not be airtight in order to prevent siphoning.

**To prevent siphoning the drain hose should not extend more than 20 mm from the end of the guide. The height of the standpipe or tub should be between 850 - 1200 mm. The drain hose can be trimmed to length.**

- Regularly check that your standpipe or tub is free from lint or other obstructions, which may affect how your washer works or may cause flooding.
- In multi-storey apartments or any upper floor, the washer should be installed on a floor equipped with a drain.
- Draining must comply with local by-laws.
- We recommend replacing the inlet hoses every 5 years. Hoses should be checked from time to time and replaced if any wear, cuts, bulges, kinks or leaks are found.

## Electrical connection

- This appliance must be supplied with a 220 - 240V, 50Hz, sinusoidal, 10A electrical supply.
- Check the power cord for damage, making sure it is not squashed or twisted.
- A damaged power cord must be replaced by a Fisher & Paykel trained and supported service technician, in order to avoid a hazard.
- The appliance must not be operated until it is repaired, as there is a risk of electric shock.

<b>SPARE PARTS*</b>	<b>PART NO.</b>
Blanking Cap	388491P
Hose Inlet Long (2m)	422680P
Hose Inlet Large Bore	426123P
Drain Hose Extension	425627P

\*Available from your Fisher & Paykel dealer or a Fisher & Paykel trained and supported service technician.

# INSTALLATION INSTRUCTIONS

## **Completing the installation**

- Turn on the water and check all hose connections for leaks. Ensure there are no kinks in the hoses. Check the hose connections for leaks again after 24 hours.
- Uncoil power cord, remove and discard the plastic pin cover, and plug into wall socket.

**If there are any problems, you must address these before proceeding with normal use. The washer will automatically turn off at the end of the cycle if there are no problems.**

## BEFORE YOUR FIRST WASH

---

### Check you have done everything you need to before you start your first wash:

- Has the base space packer been removed?
- Is the drain hose threaded through the hose guide 'U bend' (with no more than 20mm extended) and hooked into your standpipe or tub, or attached to a spigot?
- Is the hot hose connected to the Hot valve marked 'H'?
- Is the cold hose connected to the Cold valve marked 'C'?
- Have the taps been turned on?
- Is the washer correctly levelled, feet are extended and cabinet corners are clear of the floor?
- Has the power cord been connected to an appropriate power supply and the power turned on?

If you bought a QuickSmart™ model, it is a good idea to check the warm fill temperature (refer to 'Changing pre-set options – Wash temperatures').

### WashSmart™ washer and QuickSmart™ washer capacities

The table below outlines what is included in a 5.5kg and 6.0kg wash load (in accordance with AS/NZS 2040.1:2005).

WASH LOAD	5.5kg	6.0kg
Sheets (double)	2	2
Bath towels	4	5
Tablecloths	2	2
Shirts	2	3
T-Shirts	3	3
Pillowcases	4	4
Shorts	3	3
Washcloths	5	4
Handkerchiefs	4	5

#### Note:

- The above load composition is indicative only. We recommend for everyday use that you separate out your sheets and towels and wash them separately on the **REGULAR** cycle.
- Note: the WA8056M and WA8056G models have a different capacity based on country standards. Refer to the serial plate on the back of the product.

## SAFETY FEATURES

---

### Lid Lock

The lid of your washer is locked for some parts of the wash cycle, ensuring safety for you and your family while it is operating.

The **LID LOCKED** light (above the ►||) is illuminated when the lid lock is activated, letting you know at a glance if you can open the lid or not.

**To unlock the lid at any time during the cycle press ►|| .**

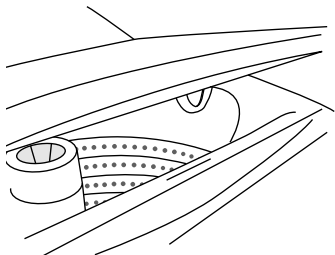

If the lid is left open, your washer will be unable to lock the lid, and the cycle will be halted. The washer will play a tune and the **LID LOCKED** light will flash to alert you. If this occurs, close the lid and press ►||

**Do not put anything down the lid lock slot in the top deck of your washer.**  
**Do not try to disable the lid lock.**

## CONTROL PANEL

### Washsmart™ Washer

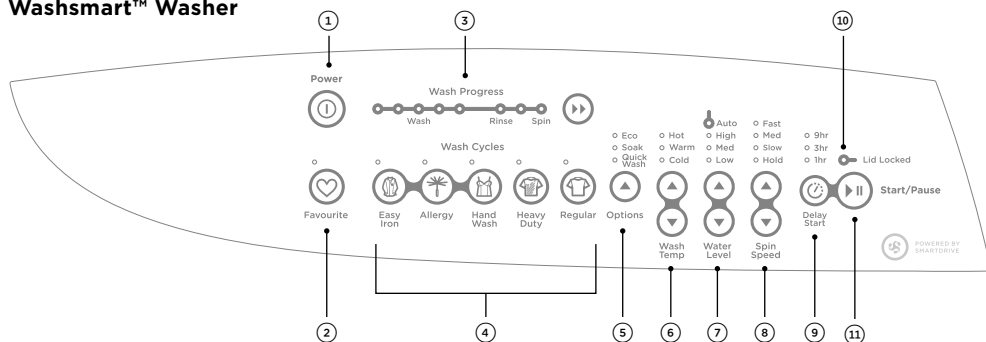

- |   |                      |  |
|---|----------------------|--|
| ① | <b>POWER</b>         | Press to turn the washer ON/OFF.   |
| ② | <b>Favourite</b>     | Press and hold to program a cycle favourite.   |
| ③ | <b>Wash Progress</b> | Indicate the current status of the wash cycle. <ul style="list-style-type: none"> <li>• All lights are illuminated at the start of the wash cycle.</li> <li>• The light of the current status flashes, and then turns off once completed.</li> <li>• Push ►► to advance the wash cycle.</li> </ul> |
| ④ | <b>Wash cycles</b>   | Press to select the desired cycle for your load.   |
| ⑤ | <b>Options</b>       | Press to select Quick Wash, Soak or Eco.   |
| ⑥ | <b>Wash Temp</b>     | Press to select the water temperature.   |
| ⑦ | <b>Water level</b>   | Press to select the water level for your wash.<br>If Auto is selected your wash will automatically select the most efficient water level for the load.   |
| ⑧ | <b>Spin Speed</b>    | Press to select the washer spin speed  |
| ⑨ | <b>Delay Start</b>   | Press to increase or decrease the delay start time.  |
| ⑩ | <b>Lid Lock</b>      | Illuminates to indicate the lid of the washer is locked.<br>To open the washer pause the cycle.  |
| ⑪ | <b>START/PAUSE</b>   | Press to start or pause the selected wash cycle.   |

## CONTROL PANEL

### Quicksmart™ Washer

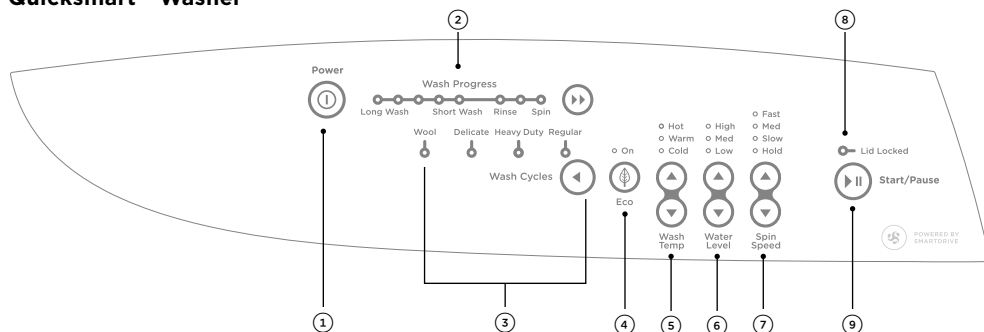

① <b>POWER</b>	Press to turn the washer ON/OFF.
② <b>Wash Progress</b>	Indicate the current status of the wash cycle. <ul style="list-style-type: none"> <li>• All lights are illuminated at the start of the wash cycle.</li> <li>• The light of the current status flashes, and then turns off once completed.</li> <li>• Push ►► to advance the wash cycle.</li> </ul>
③ <b>Wash cycles</b>	Press to select the desired cycle for your load.
④ <b>Eco</b>	Press to select Eco.
⑤ <b>Wash Temp</b>	Press to select the water temperature.
⑥ <b>Water level</b>	Press to select the water level for your wash. If Auto is selected your wash will automatically select the most efficient water level for the load.
⑦ <b>Spin Speed</b>	Press to select the washer spin speed.
⑧ <b>Lid Lock</b>	Illuminates to indicate the lid of the washer is locked. To open the washer pause the cycle.
⑨ <b>START/PAUSE</b>	Press to start or pause the selected wash cycle.

## WASH CYCLES

### Washsmart™ Washer

CYCLE	DESIGNED FOR	WASH TIME* (MIN)	WASH ACTION	WASH TEMP	RINSE	SPIN SPEED	SPIN TIME** (MIN)
<b>Regular***</b>	For normally soiled everyday cotton loads, eg t-shirts, shorts, shirts.	12	Regular	Warm/ Cold	Spray/ Deep Rinse	Fast	6
<b>Heavy Duty</b>	Recommended cycle for heavily soiled durable garments, eg tea towels, children's clothes.	15	Heavy Duty	Warm	Spray/ Deep Rinse	Fast	6
<b>Hand Wash</b>	Designed for delicate lightly soiled clothes.	6	Hand Wash	Warm/ Cold	2 Deep	Slow	4
<b>Easy Iron</b>	Designed for items susceptible to creasing eg shirts, dress trousers.	9	Regular	Warm/ Cold	2 Deep Rinses	Slow	2
<b>Allergy</b>	Recommended cycle for people with skin and other sensitivities.	12	Regular	Hot	2 Deep Rinses	Fast	6

\* Refers to the agitation time in the 'wash' part of the cycle, not the total time taken to complete a cycle.

\*\* Refers to the length of time when at the maximum spin speed.

\*\*\* The 'Regular' cycle with 'Auto' water level, 'Warm/Cold' wash temp, 'Fast' spin speed and the 'Eco' option selected is the recommended water and energy saving cycle for normally soiled, everyday washing.

Note: For users in markets with cold supply only, the wash temperature will default to cold wash temperature.



## WASH CYCLES

### Quicksmart™ Washer

CYCLE	DESIGNED FOR	WASH TIME* (MIN)	WASH ACTION	WASH TEMP	RINSE	SPIN SPEED	SPIN TIME** (MIN)
<b>Regular***</b>	For normally soiled everyday cotton loads, eg t-shirts, shorts, shirts.	12	Regular	Warm	Spray/ Deep Rinse	Fast	6
<b>Heavy Duty</b>	Recommended cycle for heavily soiled durable garments, eg tea towels, children's clothes.	15	Heavy Duty	Warm	Spray/ Deep Rinse	Fast	6
<b>Delicate</b>	Designed for delicate lightly soiled clothes.	6	Delicate	Warm	2 Deep Rinse	Slow	4
<b>Wool</b>	Designed for machine washable woollen items.	6	Delicate	Warm	Spray/ Deep Rinse	Medium	6

\* Refers to the agitation time in the 'wash' part of the cycle, not the total time taken to complete a cycle.

\*\* Refers to the length of time when at the maximum spin speed.

\*\*\* The 'Regular' cycle with 'High' water level, 'Warm' wash temp, 'Fast' spin speed and the 'Eco' option selected is the recommended water and energy saving cycle for normally soiled, everyday washing.

Note: For users in markets with cold supply only, the wash temperature will default to Cold wash temperature.

## WASH PREPARATION

---

### Sorting

Sort items according to colour, fabric type, and soil type. Wash fine, delicate fabrics separately from thick, heavy fabrics. Always separate coloured items from whites, especially when they are new. Colour run could be an issue if you wash items at higher temperatures. Some soils, like mud and blood are best washed in cold water. Oily soils (eg some foods and marks on shirt collars) are best washed in warm water.

The care label will tell you about the fabric of the garment and how it should be washed.

### Before you load

- Check pockets for items that could damage your clothes or get caught in the washer.
- Close zippers, hooks and eyes, and other fastenings (ie fasten the opening of duvet/ doona covers) and remove loose bra wires. All these can damage both your washer and your clothes.
- Place delicate items, such as lingerie, in a mesh laundry bag before placing in the washer.
- Pre-treat any stains, taking care not to spray pre-treaters on your washer as they can cause damage to the plastic surfaces.

### Ensure the water level suits the load size

If manually selecting the water level, select the correct water level by using the mark on the agitator nearest to the top of the load. Ensure the load does not extend above the bottom of the fabric softener dispenser cup, as splashing may occur.

### For a balanced load

- Place unfolded clothes firmly and evenly around the agitator, no higher than the bottom of the fabric softener dispenser cup.
- Do not wrap large items, such as sheets, around the agitator.
- A mixture of small and large items will wash best.

In the unlikely case of an out of balance load, refer to the 'Levelling instructions' to check the machine is correctly levelled.

# WASH PREPARATION

## Selecting the right detergent

- We recommend using domestic laundry detergent. Use powder or liquid detergent for 'Top Loader' washers.
- When washing wool items, remember to use a detergent specifically recommended for woollens.
- Soap flakes or granulated soap powders should not be used in your washer.
- Pods—Detergent pods are a 'no mess' alternative to powdered or liquid detergent. They should be placed down the centre of the agitator.

## How much detergent?

Follow the instructions on the back of the detergent packet as a guide to the correct amount of detergent to use. The correct amount of detergent will vary, depending on the amount of soil in your clothes and the size of your load. Jeans and work clothes may need more detergent, while towels usually need less. The larger your load, the more detergent you may have to add.

## Adding the detergent

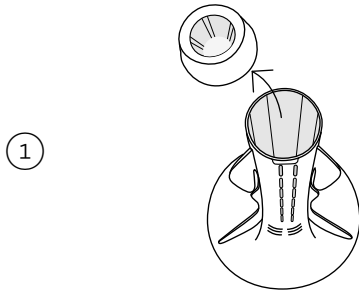

Remove the fabric softener dispenser cup.

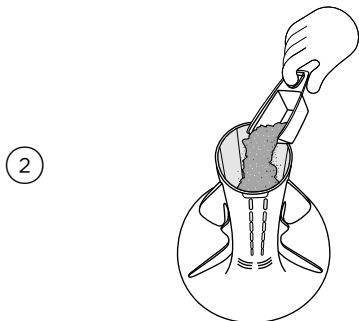

Place pod or liquid or powder detergent down the centre of the agitator. Pre-dissolving detergent in warm water (before adding it to the washer) when washing in cold water can improve the performance of the detergent.

Replace the fabric softener dispenser cup (this prevents small articles falling down the centre of the agitator)

## WASH PREPARATION

---

### How the fabric softener is dispensed

The fabric softener goes into the dispenser cup on the top of the agitator. During the rinse the washer spins to release the fabric softener, delivering it down the agitator stem as the washer fills for the final deep rinse.

If fabric softener is not added to the washer correctly, it may contribute to 'scrud' (refer to the next page).

The **QUICK** cycle and **ECO** option are not designed to be used with fabric softener as the fabric softener will not be dispersed correctly.

### How much fabric softener?

Follow the manufacturer's recommendations on the fabric softener packaging for the correct dosage. The ring on the dispenser cup is a guide only for the maximum amount of fabric softener to add for a full load. Smaller loads require less fabric softener.

### Cleaning the dispenser

When using fabric softener, rinse your dispenser at the end of each wash.

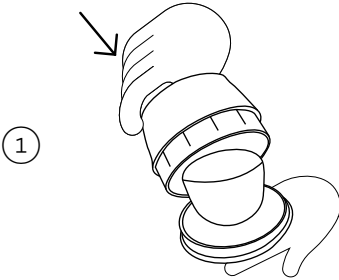

Separate the cup from the dispenser body by pushing downward on the base of the cup.

Rinse both parts of the dispenser using warm soapy water.

## WASH PREPARATION

---

### Scrud

Scrud is the name given to the waxy build-up that can occur within a washer when the fabric softener comes into contact with detergent. This can happen when fabric softener is not added to the washer correctly. This build-up is not brought about by a fault in the washer. If scrud is allowed to build-up in the washer, it can result in stains on your clothes and/or an unpleasant smell in your washer.

#### If you wish to use fabric softener we recommend:

- Using fabric softener sparingly.
- When filling the dispenser, do not splash or overfill.
- Clean the dispenser as soon as the cycle has finished.
- Clean your washer regularly, refer to the 'Caring for your washer' section.
- Cold water washing increases the chance of a build-up of scrud occurring. We recommend a **WARM** or **HOT** wash at regular intervals, eg approximately every 5th wash.
- Fabric softener of a thinner consistency is less likely to leave residue in the dispenser and contribute to a build-up.

# GETTING STARTED QUICKLY

## WashSmart™ model

1



Press **I** to activate your WashSmart™ washer.

2

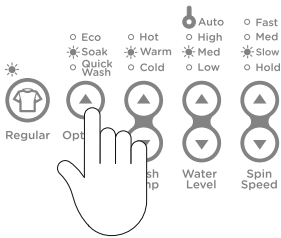

Choose your wash options, eg you may want a **REGULAR** wash with a **WARM** wash temperature, **MEDIUM** water level and a **SLOW** spin speed.

Press the **OPTIONS** button if you want to choose **ECO**, **SOAK** or **QUICK WASH**.

3



Press **▶||**

# GETTING STARTED QUICKLY

## QuickSmart™ model

1



Press **I** to activate your WashSmart™ washer.

2

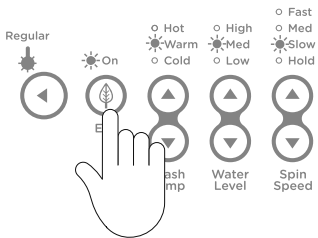

Choose your wash options, eg you may want a **REGULAR** wash with a **WARM** wash temperature, **MEDIUM** water level and a **SLOW** spin speed.

If you wish to save water press the **ECO** option button.

3



Press **▶||**

## GETTING STARTED QUICKLY

---

### To advance the wash cycle

1



Press the ►► button repeatedly to advance the cycle to the desired position.

2



Press ►||.

Each wash progress light equals 3 minutes of agitation. The **ECO** option wash progress lights may in some cases wash for longer. This is dependent on the water level. The **QUICK WASH** option shortens the agitation time for each progress light (WashSmart™ model only).



## WASH OPTIONS

### Manual water level selection

The agitator has five levels marked on its stem that can be used to help you select the correct water level. Select the correct water level by using the mark nearest to the top of the load.

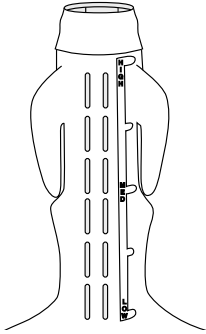

- The levels marked on the agitator do not correspond exactly to the level of the water. They indicate the level of dry clothes suitable for the water level.
- Your washer may occasionally add water during agitation. This is to maintain the water level due to the release of air trapped in the garments.
- The medium/high and medium/low settings are available on the WashSmart™ model only.
- Out of balance loads, tangling or splash-over can be caused by selecting a water level that is too high.

### Water Level

#### Auto water level (WashSmart™ model only)

1

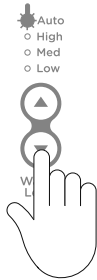

Place your clothes in the machine and select the wash cycle. Press **AUTO** water level if not automatically selected.

2



Press ►||.

During fill, the washer will pause occasionally to sense the water level. The washer will check if the water level is correct by using a series of two different agitate strokes. A slow stroke to sense the load and an agitate stroke to mix the load. (This may take over a minute.) If the washer detects that the water level is not high enough, it will add more water and re-check the level.

## WASH OPTIONS

---

- When washing an unusual load, eg large bulky garments or pillows, we recommend you manually select the water level and select the **HAND WASH** cycle (WashSmart™ model) or the **DELICATE** cycle (QuickSmart™ model).
- If there is already water in the bowl, it is best to manually select the water level.

If you feel the **AUTO** water level does not fill to the correct level, you can adjust the level the washer selects (refer to 'Changing pre-set options').

### Wash Advance - Eco

#### WashSmart™ and QuickSmart™ models

Use the **ECO** option to save water. The **ECO** option uses an Eco Spray rinse which has been specially designed to use at least 25% less water than a traditional rinse. Use this option when you want to use less detergent and less water. However, if you have low water pressure or sensitive skin it is better to use a traditional rinse.

The **ECO** option has not been designed to be used with fabric softener, as it does not have a second deep rinse to dispense the softener correctly. Fabric softener should not be used if this option is selected.

The **ECO** option is only available on the **REGULAR** and **HEAVY DUTY** cycles. If you try to select this option on the **HAND WASH**, **ALLERGY** or **EASY IRON** cycles (WashSmart™ model), or the **WOOL** or **DELICATE** cycles (QuickSmart™ model), your washer will not allow you to select it. **ECO** will take slightly longer than a normal spray and deep rinse.

There are some wash loads that may not suit being washed using the **ECO** option. For instance, loads that have a lot of sand or sawdust in them or garments where the colour still runs from them.

### Quick wash

#### WashSmart™ model only

Our WashSmart™ model provides an excellent opportunity to save time. Use the **QUICK WASH** option to halve the wash time during the **REGULAR**, **HEAVY DUTY**, **HAND WASH** or **EASY IRON** wash cycles. We recommend using the **QUICK WASH** option for lightly soiled loads.

When the **QUICK WASH** and **SOAK** options are selected at the same time, the soak time will also be halved.

The **QUICK WASH** option has not been designed to be used with fabric softener as it does not have a second deep rinse to dispense the softener correctly. Fabric softener should not be used if this option is selected.

### Soak

#### WashSmart™ model only)

Use the **SOAK** option to soak clothes at the end of the wash phase or when you wish to re-use the wash water.

## WASH OPTIONS

When you select **SOAK** your washer will soak for a period of 2 hours before completing **RINSE** and **SPIN**. During **SOAK** your washer will agitate for a few seconds every minute.

When both the **SOAK** and **QUICK WASH** options are selected, the soak time will be halved.

### Spin Hold

#### WashSmart™ and QuickSmart™ models

Use the **SPIN HOLD** option to:

- Remove drip dry garments from a mixed load before the wash goes into **SPIN**.
- Minimise the clothes creasing when they are left to sit in the bottom of the bowl at the end of the cycle.

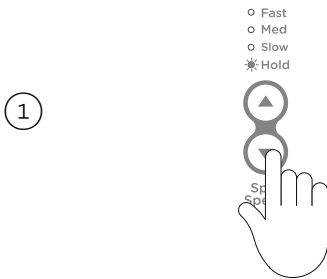

Select **SPIN HOLD** option.



The washer will pause at the end of **RINSE**, beep and the **SPIN** light will flash to tell you that it is waiting for another instruction.



Press ▶ ||

The spin speed will be the default speed for the cycle.

## WASH OPTIONS

---

### Delay Start

#### WashSmart™ model only

**DELAY START** will delay the start of the wash cycle for 1, 3 or 9 hours.

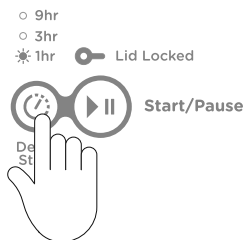

Press **DELAY START** once for a delay of 1 hour. Press again for 3 hours, a third time for 9 hours (and again to return to normal).

Once you press **DELAY START** your washer will begin the delay period. You do not have to press **▶||**. Be careful if using **DELAY START** for non-colourfast clothes as dyes may run if the clothes are damp. Your washer will not beep at the end of the cycle if **DELAY START** is selected.

## WASH OPTIONS

### Clothes care safeguards

To avoid accidentally damaging your clothes there are a few options that your washer will not accept. For example, you cannot select a **HOT** wash on the **HAND WASH** or **EASY IRON** cycles (WashSmart™ model) and **DELICATE** or **WOOL** cycles (QuickSmart™ model), nor can you select the **ECO** option on anything other than the **HEAVY DUTY** or **REGULAR** cycles (both models).

### Washing bulky items

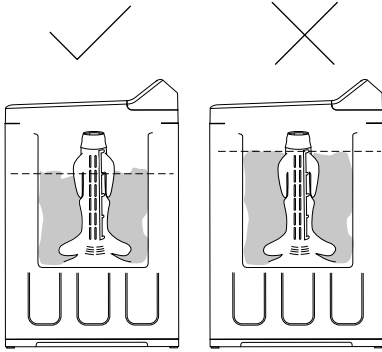

Forcing large items into the machine may result in them being damaged during washing. Make sure there is enough room in the machine for items to move when being washed.

Some items float up during the wash (eg duvets/ doonas, water-proof and water-resistant items and pillows). If they sit too high they may touch stationary parts of the machine during agitate or spin. To minimise the chance of this happening, ensure bulky items are pushed back down into the water after fill, and pushed down again to sit below the medium high water level mark on the agitator before spinning. Select a **SLOW** spin.

**To prevent an out of balance load or splash-over we recommend washing all bulky items, including water-proof and water-resistant items, on the HAND WASH OR DELICATE cycle.**

### Washing woollens

Many woollen items carry a 'Machine Washable' care claim. The fibres of these woollens have been treated to prevent felting when they are machine washed.

- Check the care label.
- Use a wool detergent.
- Use the specially designed **HAND WASH** cycle (WashSmart™ model) or **WOOL** cycle (QuickSmart™ model).
- To dry woollens lie them flat on a towel and pat into shape. Dry out of direct sunlight.

Most handcrafted garments are not made of machine washable wool and we recommend that you wash them by hand only. Hand washed woollens may be spun in your washer (select **SLOW** spin speed).

Some wool underlays and sheepskin products can be washed in a washing machine but could produce excessive amounts of lint that may cause pump blockages.

# FAVOURITE CYCLE

## Favourite cycle

### WashSmart™ model only

The **FAVOURITE** cycle lets you programme your ideal wash cycle. It can be any wash cycle with any of its wash options and it can start from any point in the cycle. For instance, it may be a cycle to wash your gym gear or it may be a rinse and spin to finish washing the nappies.

### To set your favourite cycle

1



Press ①.

2



Press the **FAVOURITE** cycle button. Hold down for 2 seconds.

You will hear 2 quick beeps and the **FAVOURITE** light will flash.

3

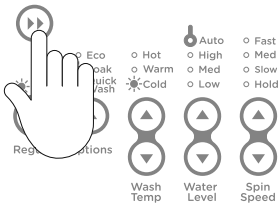

Select your preferred **FAVOURITE** cycle, eg **REGULAR**, **ALLERGY**.

Select the wash options, eg **COLD** wash, **SOAK**. Use ►► if you want part of a cycle (eg to rinse nappies).

## FAVOURITE CYCLE

---

4



Press **FAVOURITE** again to store your favourite cycle.

To change your **FAVOURITE** cycle simply repeat these steps.

### To use your Favourite cycle

1



Press **I**.

2



Press **FAVOURITE**.

The wash options of your favourite cycle will be automatically selected.

3



Press **▶II**.

# CUSTOMISING WASH CYCLES

## To customise a cycle

### WashSmart™ model only

You can program your WashSmart™ washer to remember the wash options you prefer for each wash cycle. For instance, you may want to set the **REGULAR** cycle to default to a **COLD** wash or set **HEAVY DUTY** cycle to include a **SOAK**.

To change your customised wash cycle simply repeat these steps.

- 1



Press **⏻**.
- 2



Press the wash cycle button for 2 seconds.

You will hear 2 quick beeps and the wash cycle light will flash.
- 3

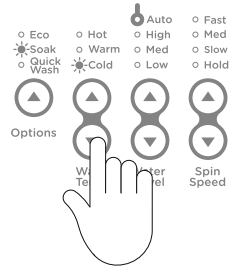

Select your wash options, eg **COLD** wash, **SOAK**.
- 4



Press the wash cycle again to store your customised cycle.



## CUSTOMISING WASH CYCLES

---

**When you are customising a wash cycle you can shorten or lengthen the wash time:**

- To shorten the wash time, press ►► to reduce the number of wash progress lights that are illuminated.
- To increase the wash time keep pressing ►► until all the wash progress lights are illuminated (refer to 'Getting started quickly – WashSmart™ model').

Unlike the **FAVOURITE** cycle you cannot customise a wash cycle to start at the **RINSE** or **SPIN** stage. On **HEAVY DUTY** you can only decrease the wash time.

# CHANGING PRE-SET OPTIONS

## Option Adjustment mode

After using your washer a number of times you may want to fine tune some of the options to suit your wash needs.

In the WashSmart™ model the following pre-set options can be changed:

- The wash temperatures.
- The RINSE option on HEAVY DUTY and REGULAR cycles.
- The COLD wash to CONTROLLED COLD.
- The number of beeps at the end of the cycle.
- The fill level selected by AUTO water level.
- The out of balance recovery routine.

Use this diagram to help you adjust the options on the WashSmart™ model.

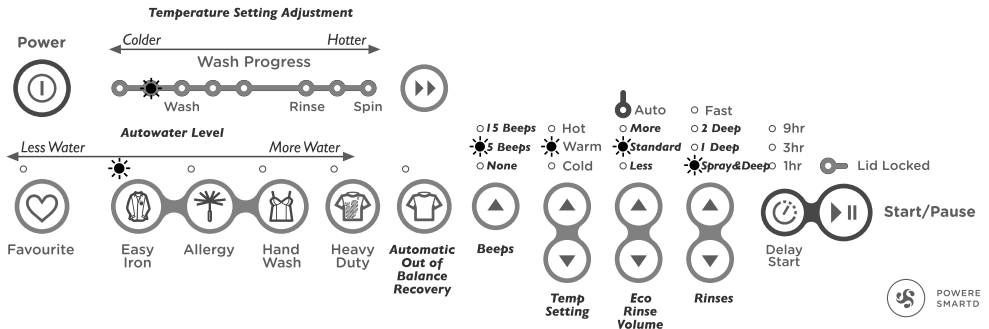

In the QuickSmart™ model the following pre-set options can be changed:

- The WARM wash temperature.
- The RINSE option on HEAVY DUTY, REGULAR and WOOL cycles.
- The out of balance recovery routine.

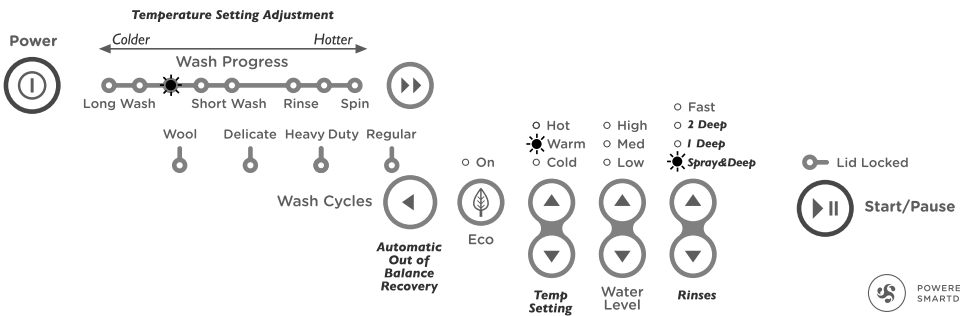

## CHANGING PRE-SET OPTIONS

### To enter Option Adjustment mode

To change or reset any of the options, repeat the below steps.

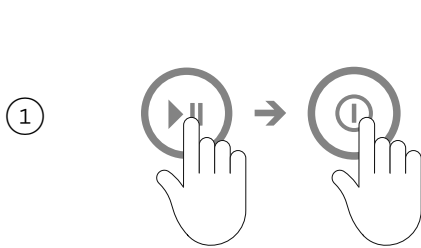

Turn washer on at the wall but do not press ①.

Press ▶|| and hold down, then press ①. You will hear two quick beeps and the washer will show an unusual pattern of lights. In this mode the lights are used to indicate the different options available.

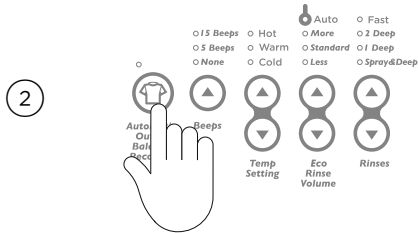

Use buttons on the panel to make your changes to the pre-set options.

(WashSmart™ washer displayed.)



Press ① to return to normal mode. Your washer will automatically remember your changes.

## CHANGING PRE-SET OPTIONS

### Wash temperatures

- On the QuickSmart™ model the **WARM** temperature can be adjusted if you think it is too hot or too cold.
- On the WashSmart™ model all wash temperatures can be individually adjusted.

The hot and cold temperatures will be the same as the respective water supply temperatures.

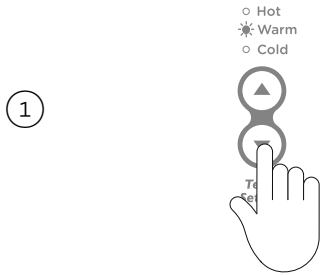

Enter the Option Adjustment mode, refer to the 'Option Adjustment mode' for instructions.

Select the **WASH TEMP** you want to adjust, for eg select **WARM**.

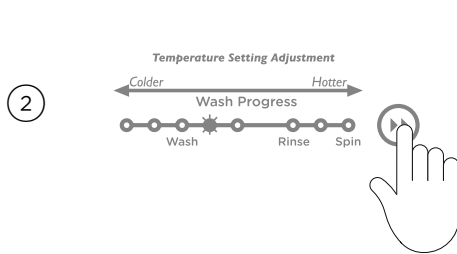

Press ►► to cause the wash progress light that is on to change.

Advancing the wash progress light will increase the wash temperature. If you keep pressing ►►, the light will scroll back to the coldest setting available for that wash temperature.

If you have a QuickSmart™ model and still can't get the temperature you require, advance the progress light ►► (while in the options adjustment mode) across to **SPIN** and manually adjust the flow of the taps).

## CHANGING PRE-SET OPTIONS

### Rinse options

You can change the pre-set rinse options on the **HEAVY DUTY** and **REGULAR** cycles of the WashSmart™ model, and on the **HEAVY DUTY**, **REGULAR** and **WOOL** cycles of the QuickSmart™ model.

The default rinse option on these cycles is a spray rinse followed by a deep rinse. The first step of the default rinse can be replaced with a short spin, or a deep rinse, by selecting another option.

Enter Option Adjustment mode, select the preferred default rinse option using the Spin Speed buttons.

	RINSE OPTIONS	
	RINSE 1	RINSE 2
'Med' spin light on	Deep rinse	Deep rinse
'Slow' spin light on	Short spin	Deep rinse
'Hold' light on (default)	Spray rinse	Deep rinse

If you have a problem with impurities in your water supply you may get a better result if you change the rinse option to two **DEEP** rinses. If you wish to conserve water, change the rinse option to one **DEEP** rinse. If you want to conserve even more water, choose the **ECO** option.

### Controlled cold

#### WashSmart™ model only

If your cold water temperature is very low you will not get a very effective wash. The **CONTROLLED COLD** option solves this problem by adding a small amount of hot water to raise the temperature of the wash to approximately 20°C. We have called this **CONTROLLED COLD**.

1



Enter the Option Adjustment mode, refer to the 'Option Adjustment mode' for instructions.

Select the **COLD** temperature from **WASH TEMP** options.

## CHANGING PRE-SET OPTIONS

2

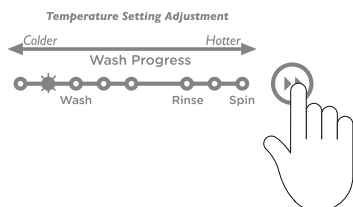

When the first progress light (from the left) is on, the washer will fill with cold water only.

Press ►► to select the second light (from the left) and your washer will control the temperature to approximately 20°C. Each following light approximately equals a 1°C temperature rise.

### End of cycle beeps

#### WashSmart™ model only

The beeps signalling the end of the cycle can be increased or decreased. Enter option adjustment mode, press the options button to increase the number of beeps or press again for no beeps to sound at the end of the cycle.

### Auto water fill level

#### WashSmart™ model only

If you are not satisfied with the level that your washer fills to on **AUTO** water level, you can increase or decrease the fill level that **AUTO** will select. Enter option adjustment mode, select the preferred cycle button to increase or decrease the auto water fill level.

If you feel there is not enough water for the load, we recommend you check by pausing the washer and pushing the clothes down to see how much spare water is at the bottom of the bowl. Clothes often float and your washer can sense the water under the clothes.

LIGHT ON	OPTION
Favourite	less water
Easy iron	factory setting
Allergy	more water +
Hand wash	more water ++
Heavy duty	more water +++

## CHANGING PRE-SET OPTIONS

### Out of balance recovery routine

When your washer is spinning it can sense if the wash load is out of balance. If an out of balance load is detected, the washer will stop and re-try spinning up to three times. If it still senses an unbalanced load there are two options the washer can take.





#### Automatic recovery option

Your washer will try to automatically correct the out of balance load. It will fill with water and agitate to redistribute the load before trying to spin up again.

#### Washer stops option

Your washer will stop, give a short burst of beeps every five seconds, and the **RINSE** or **SPIN** light will flash. You must redistribute the load more evenly yourself (use this option if you wish to conserve water).

Enter Option Adjustment mode, and use the table below to select your preferred recovery option.

WashSmart™		QuickSmart™	
			
Regular	Regular	Regular	Regular
'Regular' light on = automatic recovery	'Regular' light off = washer stops	'Regular' light on = automatic recovery	'Regular' light off = washer stops

Adjusting the out of balance recovery routine

## CARING FOR YOUR WASHER

### When you have finished using your washer

- Turn off the taps to prevent the chance of flooding should a hose burst.
- Turn off the power at the wall.

### Cold water washing

If you always wash with cold water, we recommend that a **WARM** or **HOT** wash be used at regular intervals, eg every 5th wash should be at least a warm one.

### Cleaning your washer

Ensure the power is turned off at the wall before cleaning your washer.

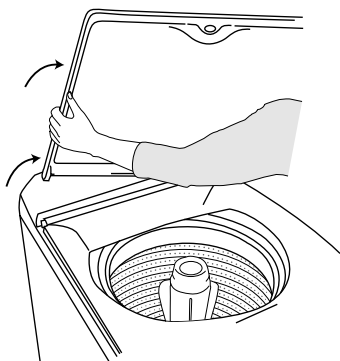

- Clean the surfaces of your washer with a soft damp cloth only and wipe dry. Do not use scouring or spray cleaners as they can damage the paint, plastic and panel surfaces.
- Clean the fabric softener dispenser after each cycle using warm soapy water.
- To remove the agitator for cleaning, unscrew the nut down the centre of the agitator by turning anti-clockwise.
- You can remove the lid for cleaning. Open the lid fully, hold one side with one hand and gently tap the other side with an upward motion. To replace the lid, hold the lid vertically and align both hinges before pushing down firmly.

**The agitator must be fully pushed onto the shaft when refitting. Tighten the nut firmly by hand. Ensure the agitator is not loose.**

### Cleaning the inside of your washer

If you use fabric softener or do regular cold water washing, it is important that you occasionally clean the inside of your washer.

We recommend doing this 5-6 times a year, and using commercial washing machine cleaners only. Ensure the cleaner used is compatible with your waste water system, i.e. safe for use if you have a septic tank. Follow the manufacturers instructions. We suggest not having any items in the washer during this cycle.

①



Fill your washer with hot water.

Press ①, select the **REGULAR** cycle.

(WashSmart™ washer displayed.)



## CARING FOR YOUR WASHER

2

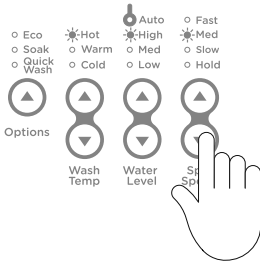

Select **HIGH** water level, **HOT** water temperature and **MEDIUM** spin speed.

(WashSmart™ washer displayed.)

3

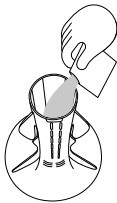

Add the washing machine cleaner directly down the centre of the agitator, follow the manufacturers instructions.

4



Press ▶||.

Let the washer complete the cycle.

5

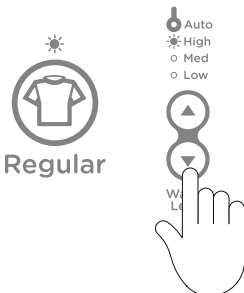

Select and run a **REGULAR** cycle on **HIGH** water level to remove any remaining detergent and scrud.

(WashSmart™ washer displayed.)

## CARING FOR YOUR WASHER

---

### Products that might damage your washer

- Concentrated bleaches, laundry pre-soakers/sanitiser, stain removers and hydrocarbon solvents (eg petrol and paint thinners) can cause damage to the surfaces eg control panel, and components of your washer.
- Be careful when washing garments stained with solvents as they are flammable. DO NOT put them in your dryer.
- Use of dyes in your washer may cause staining of the plastic components. The dye will not damage the washer but we suggest you thoroughly clean your washer afterwards. We do not recommend the use of dye strippers in your washer.

### Washer sounds and beeps

- Your washer may make sounds that you will not have heard from other clothes washers. During drain you will hear the pump in your washer turn off and on quickly about every 10 seconds.
- While draining, your washer may give several low thuds. Your washer is checking that the water has drained before spinning.
- Your washer will beep if you have used **SPIN HOLD** or **SOAK** and at the end of the cycle.
- If your washer is beeping continuously or giving a musical series of beeps, refer to the 'Before you call for service' section.

### Automatic lint system

Your washer has a self-cleaning lint system. The washer automatically separates the lint from the wash water, traps the lint between the inner and outer bowls and flushes it out at the end of the wash.

### Saving water, energy and the environment

Water efficient washing machines will save you money, but it is also worth thinking about energy use, recycling water and the environment. Some options to consider are:

- Turn the washer off at the wall when not in use.
- Turn off the taps when not in use.
- Wash full loads rather than several smaller loads.
- Use the **AUTO** water level option/function (where available).
- Use the **ECO** option/functions (where available).
- Follow instructions on the detergent packet — do not overdose.
- Use concentrated detergent — it costs less per wash.
- Consider re-using the washing machines grey water on the garden or for flushing your toilet — more information can be found on government websites promoting energy and water saving.

## BEFORE YOU CALL FOR SERVICE

---

### User warnings

Your washer is capable of self diagnosis and may sound a series of beeps and display a notification or warning to inform you when there is a problem. In most cases you will be able to address the problem the washer is alerting you to. Check this chart before you call for service.

PROBLEM	DISPLAYED AS	WHAT TO DO
<b>The washer is not getting any hot water.</b>	<b>HOT</b> water temperature light flashing.	Hot water supply is not hot enough to maintain the wash temperature you have selected. Select a lower wash temperature.
		Inlet hose filters may be blocked and should be cleaned or replaced.
		There may be a kink in the hose, undo the hose to remove the kink, and reattach. Damaged hoses should be replaced.  Ensure the hot tap has been turned on.  Check the inlet hoses are connected to the correct taps.
<b>The washer is not getting any cold water.</b>	<b>COLD</b> water temperature light flashing.	Ensure cold tap has been turned on.
		Inlet hose filters may be blocked and should be cleaned or replaced.
		There may be a kink in the hose, undo the hose to remove the kink, and reattach. Damaged hoses should be replaced.
		Check the inlet hoses are connected to the correct taps.
		Cold water temperature exceeds recommended limits, refer to 'Installation instructions'.  The flow rate of the supply water is too slow. Refer to a registered plumber for advice.
<b>The washer is not getting any water.</b>	<b>HOT and COLD</b> temperature light flashing.	Ensure the taps have been turned on.
		Inlet hose filters may be blocked and should be cleaned or replaced.
		There may be a kink in the hose, undo the hose to remove the kink, and reattach. Damaged hoses should be replaced.
		The drain hose is too low or the drain hose is pushed into the standpipe too far and the water is siphoning out of the washer, refer to 'Installation instructions'.  The flow rate of the supply water is too slow. Refer to a registered plumber for advice.

## BEFORE YOU CALL FOR SERVICE

PROBLEM	DISPLAYED AS	WHAT TO DO
<p>The washer is overloaded.</p>	<p>HIGH water level light flashing.</p>	<p>The washer is overloaded and cannot agitate. Ensure the washer is stationary. Remove items until the remaining ones can move freely.</p> <p>Select a higher water level.</p>
<p>The washer has a suds build-up.</p>	<p>First RINSE progress or SPIN progress light flashing.</p>	<p>The washer has a suds build-up (too much detergent may have been used for the amount of soil in the load). Wait for suds to dissolve (about 20min.) Rinse clothes using a deep rinse.</p>
<p>The lid can't lock or the lid is open.</p>	<p>LID LOCKED light flashing.</p>	<p>Make sure the lid is closed.</p> <p>Press ►  , refer to 'Lid Lock'.</p> <p>If the symptom persists call you Fisher &amp; Paykel dealer or Fisher &amp; Paykel trained and supported service technician.</p>
<p>The washer is out of balance.</p>	<p>First RINSE or SPIN progress light flashing.</p>	<p>Wash load is out of balance. Ensure the washer is stationary. Manually redistribute the load.</p> <p>Check the washer is level, refer to 'Installation instructions'.</p>

## FAULT CODES

---

### **Your washer sounds a musical series of beeps every 5 seconds and... possible solutions.**

Some lights are on but the pattern of lights is unfamiliar.

- ① Turn your washer off at the wall.
- ② Wait for 60 seconds and turn it back on.
- ③ Check the washer is level (refer to Installation Instructions section).
- ④ Remove load and retry.
- ⑤ Put through a 'Deep Rinse' and 'Spin'.
- ⑥ If the fault reoccurs, repeat Step 1.

If the washer still will not work you will be required to call a Fisher & Paykel supported and trained service technician to arrange service.

## TROUBLESHOOTING

The following is a list of problems you may encounter when using this appliance and some suggestions that may help to correct the problem. If you still have problems, please contact your Fisher & Paykel trained and supported service technician or our Customer Care Centre.

### Solving operating problems

PROBLEM	POSSIBLE CAUSES	WHAT TO DO
Washer not turning on.	Power not switched on at the wall.	Switch the power on at the wall. Then press <b>1</b> .
	Household power supply not working.	Try plugging in another electrical appliance.
Washer not filling with water when ► II pressed.	Inlet taps not turned on.	Check that both the hot and cold taps are turned on.
	Blocked inlet hose filters.	Clear blockages from inlet hose filters.
	'Delay Start' is set.	Refer to 'Delay Start' for more information about the <b>DELAY START</b> function.
Washer is filling continuously.	Drain hose is not installed correctly.	Ensure drain hose is located in standpipe or tub.  Ensure standpipe is at least 850mm high but no more than 1200mm high.
	Washer could be siphoning.	To prevent siphoning ensure the drain hose does not extend more than 20mm from the end of the hose guide, refer to 'Draining'.
Washer is not spinning properly.	The load could be out of balance.	Pause washer and manually redistribute the load.
		Check the washer is level and does not rock in any direction, refer to 'Levelling instructions'.
		Check the washer does not have suds build-up.

## TROUBLESHOOTING

### Solving operating problems

PROBLEM	POSSIBLE CAUSES	WHAT TO DO
Spin speed sounds slower than normal.	Clothes are unevenly distributed in the bowl.	Washer has compensated by lowering the spin speed.
	The outer wash bowl may still be hot from being filled with hot water.	The washer has slowed the spin speed as a protective measure.
Washer is continually going out of balance.	Washer may not be level.	Check the washer is level and does not rock in any direction, refer to 'Levelling instructions'.
	Too much water for the load	Ensure an appropriate water level is selected for the load size (or select <b>AUTO</b> water level).  Refer to 'Out of balance recovery routine' for more information to change the out of balance recovery mode.
Too much or too little water when filling on auto water level.	The washer needs to determine the correct water level for the load.	Refer to the 'Wash options' section.
	Some loads do not suit <b>AUTO</b> water level, eg pillows.	Manually select the most appropriate water level for the load.
Washer is making noises.	Banging.	Load is out of balance. Press ►   and redistribute the load.
	Other noises.	Refer to the 'Caring for your washer' section.
Small puddle coming from under the washer.	The water level is too high for the amount of clothes and has caused excessive splashing.	Select a lower water level, refer to 'Water Level'.
	Large bulky garments (eg pillows, duvet) can cause splashing.	Wash on the <b>HAND WASH</b> or <b>DELICATE</b> cycle, refer to 'Washing bulky items'.

## TROUBLESHOOTING

### Solving wash problems

PROBLEM	POSSIBLE CAUSES	WHAT TO DO
Creasing.	Overloading of the washer.	Try reducing load size.
	Inappropriate cycle selection.	Choose <b>EASY IRON</b> or <b>DELICATE</b> cycle as this cycle has been designed to minimise creasing.
	Spin speed too high.	Try selecting a lower spin speed.  Do not leave wet clothes to sit in the washer or laundry basket.
	Wash temperature too high for items.	Try selecting a lower wash temperature.  Sort your load so that items of similar weight are washed together.
Poor soil removal.	Wash cycle selected not suited to soil level in load.	Are you using the most appropriate wash cycle for the amount of dirt?
	Warm wash water is too cold.	Refer to 'Wash temperatures'.
	Not enough detergent for load size or amount of soil.	Refer to the detergent package for the manufacturers recommended dosage.
	White clothes are better washed separately.	Separate light and heavily soiled items, as clothes can pick up soil from dirty wash water.
	Cold water wash is too cold.	Refer to 'Wash temperatures'.
	Wash temperature not suited to soil type in load.	Blood and mud are better washed in cold water, while oily soils are better washed in warmer water.
	Overloading the washer.	Try reducing your load size.
	A full load of items of the same size eg sheets may not wash as well.	Loads made up of articles of varying sizes will wash better.
	Hard water requires more detergent than soft water.	If you have hard water, try adding more detergent.
Tangling.	Washing with too much water (underloading) can cause the clothes to tangle around one another.	Select an appropriate water level for the load size, or select <b>AUTO</b> water level, refer to 'Wash options'.
	Items wrapped around the agitator when loading.	Place items, especially sheets, in the bowl as loose parcels.



## TROUBLESHOOTING

### Solving wash problems

PROBLEM	POSSIBLE CAUSES	WHAT TO DO
<b>Linting.</b>	Some items in load more likely to release or pick up lint.	Wash lint givers (eg towels, flannelette sheets) separately from lint collectors (eg synthetic fabrics).
	Overloading the washer.	Try reducing your load size.
	Not enough detergent to hold the lint in suspension.	Try using more detergent.
	Overdrying in a dryer can cause a build-up of static electricity in synthetic fabrics and cause them to attract lint.	Try not to over dry items when using your dryer.
<b>Detergent residue.</b>	Overloading the washer.	Try reducing your load size.
	Did you use the recommended amount of detergent?	Try using less detergent.
	Some detergents need to be pre-dissolved before being added to the washer.	Check the detergent instructions.
	Cold ambient temperatures, cold washes and/or short agitation times may not allow the detergent to dissolve properly.	Try pre-dissolving the detergent before adding it to the washer.
<b>Black or grey marks on clothes.</b>	A build-up caused by the interaction of fabric softener and detergent can flake off and mark clothes.	Refer to 'Fabric softener' and 'Caring for your washer'.
	Insufficient detergent for the amount of soil on the clothes, can result in grey marks on clothes.	Make sure you are using enough detergent for the amount of dirt in your wash load, refer to 'How much detergent?'.
<b>Dye transfer.</b>	Washing dark coloured and light coloured items together.	Remember to separate whites and colours.
	Keep wet or damp dark coloured and light coloured items separate.	Wash and dry non-colourfast clothes separately.  Non-colourfast clothes left sitting in a washer or laundry basket can transfer dye onto other clothes.

## MANUFACTURER'S WARRANTY

---

You automatically receive a two-year Manufacturer's Warranty with the purchase of this clothes washer covering parts and labour for servicing within the country of purchase.

### **Fisher & Paykel undertakes to:**

Repair or, at its option, replace without cost to the owner either for material or labour any part of the product, the serial number of which appears on the product, which is found to be defective within two years of the date of purchase.

You also receive an additional eight-year parts only Manufacturer's Warranty on your Direct Drive motor. This additional eight-year Manufacturer's Warranty commences on the day following the expiry of the two-year Manufacturer's Warranty and excludes the motor controller and labour. Fisher & Paykel will repair (as to parts) or, at its option, replace any Direct Drive motor (but not the motor controller) which is found to be defective within this additional Manufacturer's Warranty period. You will be responsible for any labour costs.

Note: These Manufacturer's Warranties are an extra benefit and do not affect your legal rights.

### **These Manufacturer's Warranties DO NOT cover**

- Ⓐ Service calls which are not related to any defect in the product. The cost of a service call will be charged if the problem is not found to be a product fault. For example:
  - ① Correcting the installation, eg removal of bottom packer and transit bolts (front loading washers), levelling the washer, adjustment of the drain to correct siphoning, noises, crossed, kinked or leaking inlet hose connections, turning on water, noises caused by the waterhammer or power supplies.
  - ② Providing instruction on use of the product or changing the set-up of the product, eg instruction on correct use of detergents and fabric softeners.
  - ③ Replacing fuses in, or correcting house wiring or correcting house plumbing, eg unblocking drains.
  - ④ Correcting fault(s) caused by the user.
  - ⑤ Noise or vibration that is considered normal, eg spin sounds, user warning beeps.
  - ⑥ Correcting damage caused by pests, eg rats, cockroaches, etc.
  - ⑦ Water on the floor due to incorrect loading or excessive suds.
  - ⑧ Blocked pumps, removal of foreign objects/substances from the washer, including the pump and inlet hose filters, eg bra wires, bread tags, nails, grit, scrud, etc.
  - ⑨ Correcting corrosion or discolouration due to chemical attack.
- Ⓑ Defects caused by factors other than:
  - ① Normal domestic use; or
  - ② Use in accordance with the product's User guide.
- Ⓒ Defects to the product caused by accident, neglect, misuse or 'act of God'.
- Ⓓ The cost of repairs carried out other than by a Fisher & Paykel trained and supported service technician or the cost of correcting such repairs.
- Ⓔ Normal recommended maintenance as set out in the product's User guide.
- Ⓕ Repairs when the appliance has been dismantled, repaired or serviced by other than a Fisher & Paykel trained and supported service technician or the selling dealer.
- Ⓖ Pick-up and delivery.

## MANUFACTURER'S WARRANTY

---

- Ⓜ Transportation or travelling costs involved in the repair when the product is installed outside the Fisher & Paykel trained and supported service technician's normal service area.

Nothing in this Manufacturer's Warranty is intended to, nor limits, any rights you may have under law to recover the costs of inspecting or returning the goods to us.

This product has been designed for use in a normal domestic (residential) environment. This product is not designed for any commercial use (whatsoever). Any commercial use by a customer will affect this product's Manufacturer's Warranty.

Service under these Manufacturer's Warranties must be provided by a Fisher & Paykel trained and supported service technician 'Customer care'. Such service shall be provided during normal business hours. This Manufacturer's Warranty certificate should be shown when making any claim.

### **For Australian customers**

This Manufacturer's Warranty is an extra benefit and does not affect your legal rights. Our goods come with guarantees that cannot be excluded under the Australian Consumer Law. You are entitled to a replacement or refund for a major failure and compensation for any other reasonably foreseeable loss or damage. You are also entitled to have the goods repaired or replaced if the goods fail to be of acceptable quality and the failure does not amount to a major failure.

**Keep this user guide in a safe place.**

## CUSTOMER CARE

---

### **Before you call for service or assistance:**

Check our website, [fisherpaykel.com](http://fisherpaykel.com), for 'Product Help' to see the latest updates, hints and tips, and information about your product.

We recommend that you also refer to your User guide to ensure:

- ① Your product is correctly installed.
- ② You are familiar with its normal operation.
- ③ You have read the 'Before you call for service', 'Fault codes' and 'Troubleshooting' at the back of the book.

If after checking these points you still need assistance or parts, you can go online to our website and book a service with your nearest Fisher & Paykel trained and supported service technician. Our Customer Care team is also available to offer you assistance.

### **In New Zealand if you need service or assistance:**

Go online to our website and book a service or call the Fisher & Paykel Customer Care Centre and talk to one of our Customer Care Consultants.

**Toll Free:** 0800 FP CARE or 0800 372 273

**Email:** [customer.care@fisherpaykel.com](mailto:customer.care@fisherpaykel.com)

**Website:** [fisherpaykel.com](http://fisherpaykel.com)

**Postal address:** Fisher & Paykel Appliances Ltd, PO Box 58546, Botany, Auckland 2163

Fisher & Paykel has a network of Fisher & Paykel trained and supported service technicians who can carry out any service necessary on your appliance. Visit our website and book a service with a Fisher & Paykel trained and supported service technician in your area.

### **In Australia if you need service or assistance:**

Go online to our website and book a service or call the Fisher & Paykel Customer Care Centre and talk to one of our Customer Care Consultants.

**Toll Free:** 1300 650 590

**Email:** [customer.care@fisherpaykel.com](mailto:customer.care@fisherpaykel.com)

**Website:** [fisherpaykel.com](http://fisherpaykel.com)

**Postal address:** Fisher & Paykel Appliances Australia Pty Ltd, PO Box 798, Cleveland QLD 4163

### **In Singapore if you need service or assistance:**

Call the Fisher & Paykel Customer Care Centre and talk to one of our Customer Care Consultants.

**Phone:** 6741 0777

**Fax:** 6547 0123

**Website:** [www.fisherpaykel.com](http://www.fisherpaykel.com)

**Postal address:** 150 Ubi Avenue 4, Sunlight Building #03-01A, Singapore 408825

Fisher & Paykel has a network of Fisher & Paykel trained and supported service technicians who can carry out any service necessary on your appliance.

Visit our website and book a service with a Fisher & Paykel trained and supported service technician in your area.

## CUSTOMER CARE

---

If you call, write to or contact us via our website, please provide your name and address, model number, serial number, date of purchase and a complete description of the problem. This information is needed in order to better respond to your request for assistance. Product details can be found on the rear of the washing machine.

### Registration

Register your product with us so we can provide you with the best service possible. To register your product visit our website: [fisherpaykel.com](http://fisherpaykel.com)

Complete and keep for safe reference:

Model	_____
Serial No.	_____
Purchase Date	_____
Purchaser	_____
Dealer	_____
Suburb	_____
Town	_____
Country	_____





**FISHERPAYKEL.COM**

© Fisher & Paykel Appliances 2021. All rights reserved.

The models shown in this guide may not be available in all markets  
and are subject to change at any time.

The product specifications in this guide apply to the specific products and  
models described at the date of issue. Under our policy of continuous product  
improvement, these specifications may change at any time.

For current details about model and specification availability in your country,  
please go to our website or contact your local Fisher & Paykel dealer.

**429897B 05.21**