

**FISHER & PAYKEL**

**INTEGRATED  
REFRIGERATOR FREEZER**

---

RS6121WLUE1, RS6121WRUE1, RS7621WLUE1 &  
RS7621WRUE1 models

**USER GUIDE  
NZ AU**



## CONTENTS

---

Product overview	10
Control panel	11
Menu	12
Using your refrigerator-freezer	13
Using the refrigerator compartment	14
Adjusting the shelves and bins	15
Using the water dispenser	17
Using the freezer compartment	18
Using the ice maker	19
Wi-Fi connection	20
Accessing the menu	21
Cleaning	22
Troubleshooting	27
Faults	30
Manufacturer's warranty and service guide	31
Customer care	32

---

### Registration

To register your product visit our website: [fisherpaykel.com/register](https://fisherpaykel.com/register)

**⚠ WARNING!**



**Electric Shock Hazard**

Failure to do so can result in death, electric shock, fire or injury to persons.

- Read and follow the safety and warnings outlined in this guide before operating this appliance.

**⚠ WARNING!**



**Tip Hazard**

- This product may tip until it is fully installed. Keep children away and take care. Failure to follow this advice may result in injury.
- This appliance is top-heavy and must be secured to prevent the possibility of tipping forward.

**To ensure that the appliance is stable under all loading conditions:**

- The anti-tip bracket and fittings supplied must be installed by a professional installer according to the installation steps in this guide.
- This product may tip when the anti-tip bracket is unscrewed. Refer to installation instructions to safely uninstall the product.



**This appliance contains flammable refrigerant isobutane (R600a).**

### READ AND SAVE THIS GUIDE

#### **WARNING!**

Read Safety Guide. Failure to follow all guides and rules could cause personal injury or property damage. When using this appliance, always exercise basic safety precautions including the following:

Use this appliance only for the intended purpose as described in the user guide and installation guide of this appliance.

#### **General**

- This appliance is designed for use in a normal domestic (residential) environment.
- Children should be supervised to ensure that they do not play with the appliance.
- Children aged 3 to 8 years may load and unload this appliance under supervision.
- Cleaning and user maintenance shall not be undertaken by children without supervision.
- This appliance can be used by children aged from 8 years and above and persons with reduced physical, sensory or mental capabilities or lack of experience and knowledge if they have been given supervision or instruction concerning use of the appliance in a safe way and understand the hazards involved.
- The manufacturer's installation instructions for appliance and cabinetry ventilation must be followed when installing the appliance.
- To avoid hazard due to instability of the appliance, it must be fixed in accordance with installation guide.
- Keep ventilation openings, in the appliance enclosure or in the built-in structure, clear of obstruction.
- Do not use mechanical devices or other means to accelerate the defrosting process, other than those recommended by the manufacturer.
- Do not damage the refrigerant circuit. In case of damage to the refrigerant circuit, ventilate the area by opening all windows.
- It is hazardous for anyone other than a Fisher & Paykel trained and supported service technician to service this appliance.
- The new hose-sets supplied with the appliance are to be used and that old hose-sets should not be reused.
- Avoid contact with the moving parts of the ice maker ejector mechanism, and do not place your fingers on the automatic ice-making mechanism while the appliance is in operation.
- It is hazardous for anyone other than an Authorised Service Person to service this appliance. In Queensland - the authorized Service Person MUST hold a Gas Work Authorisation for hydrocarbon refrigerants, to carry out Servicing or repairs which involve the removal of covers.

## SAFETY AND WARNINGS

---

### Installation

- Ensure that the appliance is secured to prevent tipping forward. Tipping of appliance can lead to serious injury or death.
- Connect to potable water supply only.
- The water connection to your Ice and water appliance must be installed by a qualified plumber or Fisher & Paykel trained and supported service technician and comply with all state and local laws.
- Installation and use MUST comply with all state and local plumbing codes. Check with your local public works department for plumbing codes. You must follow their guidelines as you install the water filtration system.
- Your water filtration system can withstand up to 120psi (827kPa) of water pressure.
- If a pressure limiting valve is supplied, ensure that it is installed before installing the water filtration system. DO NOT install if water pressure exceeds 120psi (827kPa).

### WARNING!

#### To reduce the risk associated with choking:

- DO NOT allow children under 3 years of age to have access to small parts during the installation of the water filter.

### Electrical

- Do not plug in any other appliance at the same power point as your appliance or use extension cords or double adapters.
- When moving your appliance away from the wall, be careful not to roll over or damage the power cord.
- When positioning the appliance, ensure the power cord is not trapped or damaged. If the power cord is damaged, it must only be replaced by your Fisher & Paykel trained and supported service technician.
- Do not operate electrical equipment or any other equipment that may produce arcs, sparks or flames in the area. Contact your Fisher & Paykel trained and supported service technician immediately to arrange for the appliance to be repaired.
- Do not use electrical appliances inside the food storage compartments of the appliance, unless they are of the type recommended by the manufacturer.
- Do not locate multiple portable socket-outlets or portable power supplies at the rear of the appliance.

### Temperature control

- This refrigerating appliance is intended to be used at ambient temperatures ranging from 16°C to 43°C. The appliance performance may be compromised when operating outside of the temperature range.
- Once you turn on your appliance for the first time, the cooling system will automatically cool all compartments to their set temperatures. This will take between 2 - 3 hours.
- The control panel enables you to change and control the temperatures of the compartments accurately and independently regardless of the temperature or humidity of the surroundings whether it is summer or winter.
- We recommend checking the operation of your appliance once every 4 hours for the first 24 hours.
- If at any time you notice that the appliance is not cooling properly, call your installer or Fisher & Paykel trained and supported service technician to verify if the unit is operating properly. Take immediate steps to prevent food from spoiling by storing in another appliance or freezer.
- For common foodstuffs, factory default setting provides the optimum setting for

## SAFETY AND WARNINGS

---

food care. Storing at temperatures other than settings recommended may impact the storage life.

- For storage of general household foods in the most efficient manner, it is recommended to use the product in the factory configuration supplied. Moving the shelves and bins will have a minimal impact on efficiency.

### Servicing

- All electrical repairs must be carried out by an adequately trained service technician or qualified electrician.
- Electrical shock hazard. Assume all parts are live.
- Disconnect supply before servicing and installation.
- The LED light cannot be serviced by the user. Contact your Fisher & Paykel Dealer or Fisher & Paykel trained and supported service technician.
- For spare parts, please contact Fisher & Paykel Customer Care. Spare parts are available for all Fisher & Paykel appliances for a minimum period of 10 years from the date of manufacture.

### IMPORTANT!

**Your appliance is designed to operate for many years without the need for service checks. However, if your appliance is malfunctioning, have it attended to by your Fisher & Paykel trained and supported service technician as soon as possible.**

### Cleaning

- If the appliance is left empty for long periods, switch off, defrost, clean, dry, and leave the door open to prevent mould developing within the appliance.
- Clean water tanks if they have not been used for 48 hours. Flush the water filter connected to a water system if water has not been drained for 5 days.
- Use only soap-based cleaning products. Many commercially available cleaning products contain solvents that may degrade the plastic components of your refrigerator and cause them to crack
- Avoid using anti-bacterial cleaning products on either the interior or exterior of the cabinet as they may cause rusting of metal components and cracking of plastic components.
- Regularly clean accessible draining systems and surfaces that come in contact with food.

### Disposal

- Extreme care must be taken when disposing of your old appliance to avoid hazards:
  - The flammable refrigerant gas must be safely removed by a qualified service technician.
  - The thermal insulation foam in this appliance contains flammable insulation which can emit gases. Any exposed foam may be highly flammable and must be carefully treated during disposal.
- **WARNING:** Risk of child entrapment. Before you throw away your old refrigerator or freezer, the doors and panels should be removed and the racks left in place so that children may not easily climb inside.
- Consult your local energy authority or local codes as to the best way to dispose of your old appliance.
- Your Fisher & Paykel trained and supported service technician will be able to give advice on environmentally-friendly methods of disposing of your old appliance or freezer.
- Remove all packaging and dispose of it responsibly. Recycle items that you can.

## SAFETY AND WARNINGS

---

### Storing food and drinks

- Only models with 4-star compartment(s) are suitable for the freezing of foodstuffs.
- Ensure hot foods and beverages are cooled sufficiently before placing them into the appliance. Hot items may cause other foods to warm to unsafe temperatures.
- Ensure partially or fully defrosted foods are never re-frozen — cook immediately.
- Consume food items within the recommended storage times. Discard foods that show sign of spoilage.
- Store perishable foods in the appliance immediately after purchase. Storing at room temperature increases the rate of deterioration and can allow harmful microbial growth.
- Store any raw meat or fish in sealed containers to prevent cross-contamination.
- Immediately clean any drips or spills on surfaces.
- Do not store explosive substances such as aerosol cans with a flammable propellant in this appliance.
- Never store volatile or flammable materials in your appliance as they may explode.
- Do not consume food if it is too cold. Food removed from freezer compartment may be cold enough to cause damage when brought into contact with bare skin, eg frozen ice cubes.
- Opening the door for long periods of time can cause a significant increase of the temperature in the compartments of the appliance.
- Never freeze liquids in glass containers. Liquid expands when it freezes and can cause the container to explode.
- Never freeze carbonated drinks. They may explode.

### **IMPORTANT!**

**If you suspect that the product is not getting cold — items such as ice cream are melting— remove all perishable food and store in another appliance or cooler to prevent spoilage. Immediately call for a service technician.**

### Power failure

- Do not refreeze frozen foods that have thawed completely.
- Foods that have defrosted but are still cold may be cooked immediately.
- Foods that have defrosted and are warmer than 5°C should be discarded.

**Information on food care, food modes and special features of refrigerators can be found in the online user guide and downloaded from [www.fisherpaykel.com](http://www.fisherpaykel.com)**



## PRIOR TO INSTALLATION

---

- The anti-tip bracket and fittings supplied must be fitted to the wall of the finished enclosure to withstand a 100kg load.
- Your appliance may include front and rear rollers designed for moving the appliance forward and backward. Do not move the appliance sideways as this may damage the rollers or the floor covering / surface.
- The appliance must be installed by a qualified installer, or Fisher & Paykel trained and supported service technician to avoid faulty electrical connection and water leaks.
- All connections for water, electrical power and grounding must comply with local codes and ordinances and be made by licensed personnel when required.
- Avoid installation of the appliance/s under a ground fault circuit interrupter (GFCI).
- Ensure the appliance is installed properly. Improper installation that results in appliance failure is not covered under the appliance warranty.

### Check the cabinetry

- Check the dimensions — height, width, depth, floor level, finished alcove returns.
- Ensure that the ventilation openings in the cabinetry are clear of obstruction.
- For integrated installation, a finished return of solid material is required across the top and sides of the new or existing alcove.
- Refer to the 'Product and Cavity Dimensions' prior to installation of the appliance.

### Check the power supply

- Ensure that there is a separate power outlet for the appliance.
- Avoid sharing the power point with other appliances to prevent the appliance from accidentally switching off.
- For power requirements, refer to the information on the serial plate. This is located at the front right-hand side of the drawer when open.
- Ensure your appliance is properly grounded (earthed).
- Connect the appliance to electrical supply (220-240V, 50 Hz) with fitted plug and lead.
- We recommend to use an isolating switch that is easily accessible to the user after the appliance is installed.
- Follow all local codes and ordinances when installing this appliance.

### Check the water supply (for Ice and Water models only)

- Ensure that there is a separate water supply connection for the appliance.
- Your appliance must be installed by a qualified appliance installer as incorrect plumbing can lead to water leaks.
- Fisher & Paykel is not liable for damage (including water damage) caused by faulty installation or plumbing.

### Insert hinge limiting pin

- Before opening the doors, ensure that the appliance is stable.
- Follow these steps to avoid risks that can cause serious injury or death.

For 90° door swing, a hinge limiting pin is supplied with your appliance. This pin fits in the boreholes of the top hinge

- ① Open door to 90°.
- ② Insert the hinge limiting pin vertically into the bore hole. Tap the pin gently if it does not slide smoothly.

**All product information, including product user guides and installation guides, can be sourced and downloaded from [www.fisherpaykel.com](http://www.fisherpaykel.com)**

## PRODUCT OVERVIEW



RS6121W illustrated.

### Features

- ① Control panel
- ② Adjustable glass shelves
- ③ Adjustable door shelves
- ④ Bottle holders
- ⑤ Water dispenser
- ⑥ Humidity control bins
- ⑦ Upper freezer bin
- ⑧ Automatic ice maker
- ⑨ Freezer tray
- ⑩ Lower freezer bin

## CONTROL PANEL

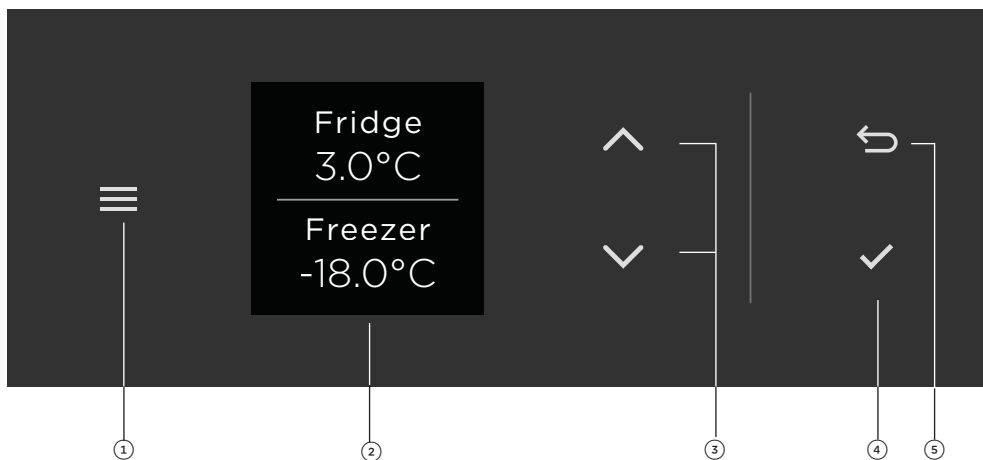

① <b>Menu</b>	Press to access product features and settings, or to return to standby. If the display has been locked, hold for two seconds to unlock.
② <b>Display screen</b>	Displays product features and settings.
③ <b>Scroll</b>	Press to select modes and adjust temperatures. Enables you to scroll through the menu, features and settings.
④ <b>Select</b>	Press to confirm and activate the selected features and settings.
⑤ <b>Back</b>	Press to go back to the previous menu.

## MENU

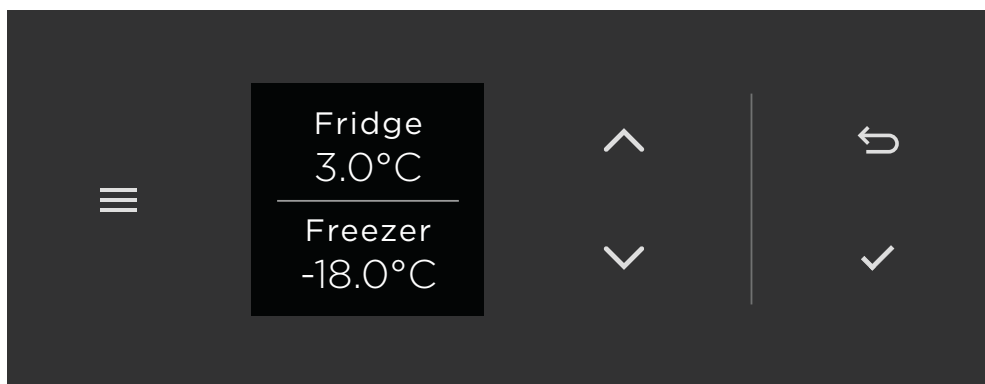

TEMPERATURE SET	Select a mode or adjust the temperature. Refer to 'Modes'.
ICE	Turn the ice maker on or off.
ICE BOOST	Boost ice production for the next 24 hours.
MAX COLD	Quickly cool down items that have just been added to the product. The product will temporarily drop to its coldest temperature.
BOTTLE CHILL	Set a 15-minute timer when chilling wine or other beverages in the freezer.
WATER DISPENSER	Lock the water dispenser to prevent accidental use.
DOOR ALARM	Mute the door alarm for 20 minutes or until the door is closed again.
DISPLAY LOCK	Lock the controls to prevent accidental use.
SABBATH MODE	For the Sabbath observant. In Sabbath Mode alarms, lights and the display will be deactivated for 80 hours. <ul style="list-style-type: none"><li>• The lights will not turn on when you open the door.</li><li>• The door alarm will not operate.</li><li>• The display will not illuminate.</li><li>• The display will be unresponsive.</li></ul>
SETTINGS	Adjust the appliance settings to suit your preferences or set up a Wi-Fi connection. Refer to 'Wi-Fi connection'.

## USING YOUR REFRIGERATOR-FREEZER

---

- Adjust the temperatures for each compartment as required.
- Select modes for the fridge and freezer compartments to suit the food you are storing.
- Arrange your shelves as desired.
- Adjust the settings to suit your preferences.

---

COMPARTMENT	MODE	
Upper compartment	FRIDGE (1 to 6°C)	For fresh, everyday foods such as fruit and vegetables, dairy products, meats, seafood, ready-to-eat foods, leftovers, sauces, preserves and drinks.
	PANTRY (11 to 13°C)	For foods that perish quickly at room temperature but are too sensitive to be stored at normal refrigerator temperatures.
Lower compartment	SOFT FREEZE (-10 to -8°C)	An extension of your refrigerator. Extends shelf life of fresh items for weeks.
	FREEZER (-21 to -14°C)	For general frozen items that require storage between 1 - 12 months.
	DEEP FREEZE (-25°C)	For frozen food items that may need to be stored for longer periods, extending shelf life by up to 6 months beyond normal freezers.

---

## USING THE REFRIGERATOR COMPARTMENT

For optimal food care, the upper compartment lets you change between three modes to keep everyday food fresh.

**FRIDGE**  
(1 to 6°C)

For fresh, everyday foods such as fruit and vegetables, dairy products, meats, seafood, ready-to-eat foods, leftovers, sauces, preserves and drinks.

**PANTRY**  
(11 to 13°C)

For foods that perish quickly at room temperature but are too sensitive to be stored at normal refrigerator temperatures.

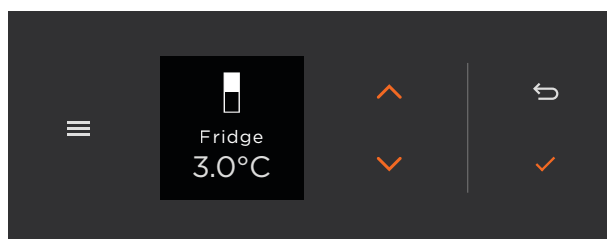

1. Press  $\nabla$  or  $\blacktriangle$  to select the upper compartment, then press  $\checkmark$  to confirm.

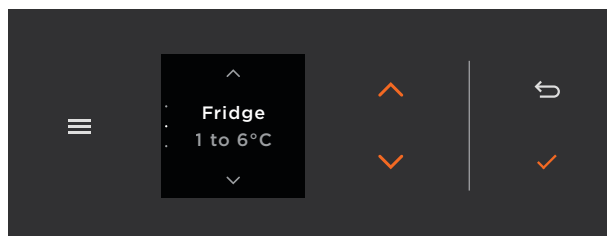

2. Press  $\nabla$  or  $\blacktriangle$  to select a mode, then press  $\checkmark$  to confirm.

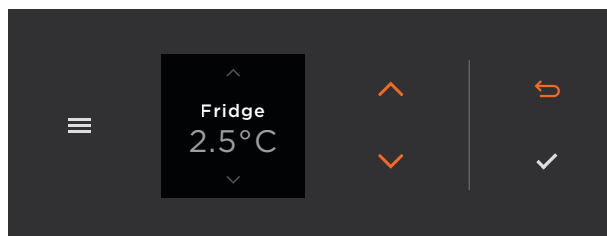

3. Press  $\nabla$  or  $\blacktriangle$  to adjust the temperature, and press  $\checkmark$  to confirm.  
Press  $\leftarrow$  at any point to exit the menu.

## ADJUSTING THE SHELVES AND BINS

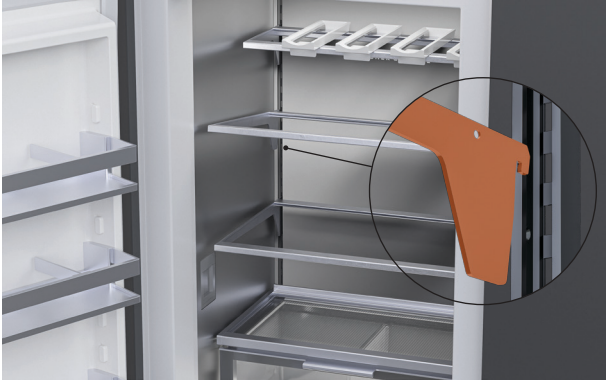

### **Glass shelves**

Adjust height or remove as needed. The shelves hook onto supports at the rear.

To remove, tilt shelf up to dislodge it from support, then pull it out.

To refit, hook the shelf back onto supports at desired height.



### **Door shelves**

Adjust height or remove. Shelves slot onto the hooks on the sides of the door.



### **Bottle holders**

Slide to reposition, and unhook to remove.

## ADJUSTING THE SHELVES AND BINS

---



### **Humidity control bin**

Reposition or remove dividers as needed. Refer to 'Cleaning' for removal instructions.



## USING THE WATER DISPENSER

The water dispenser is located on the left side in the top compartment.

Before you first use the water, dispense eight litres of water to flush the filter.

When dispensing water for long durations, a time-out period may occur, and an alarm will sound. Please wait four minutes before dispensing again.

### Replacement filters

Replace the water filter when alerted. To fit replacement filter, follow the instructions supplied with the new filter.



### Dispensing water

Gently press the dispensing pad with a glass or container.

Pressing harder will not increase the flow of water.

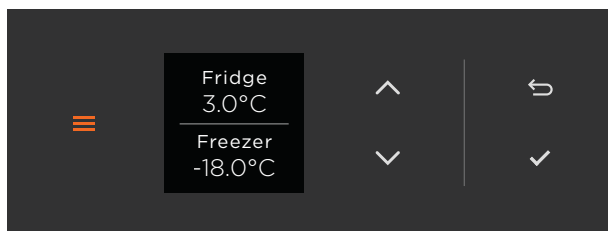

To stop, simply pull your glass or container away from the dispensing pad.

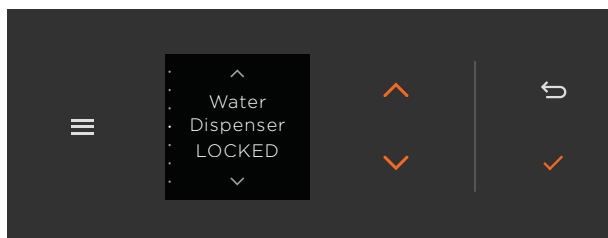

### Locking and unlocking the water dispenser

1. Press  to access the menu.



2. Press  or  to scroll to **WATER DISPENSER**, then press  to lock or unlock the dispenser.

## USING THE FREEZER COMPARTMENT

For optimal food care, the freezer lets you change between three modes - Soft Freeze, Freezer and Deep Freeze.

<b>SOFT FREEZE</b> (-10 to -8°C)	An extension of your refrigerator. Extends shelf life of fresh items for weeks.
<b>FREEZER</b> (-21 to -14°C)	For general frozen items that require storage between 1 - 12 months.
<b>DEEP FREEZE</b> (-25°C)	For frozen food items that may need to be stored for longer periods, extending shelf life by up to 6 months beyond normal freezers.

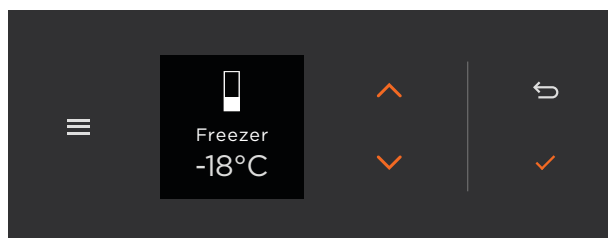

1. Press  $\nabla$  or  $\blacktriangle$  to select the lower compartment, then press  $\checkmark$  to confirm.

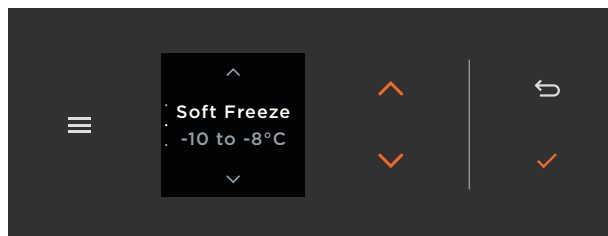

2. Press  $\nabla$  or  $\blacktriangle$  to select a mode, then press  $\checkmark$  to confirm.

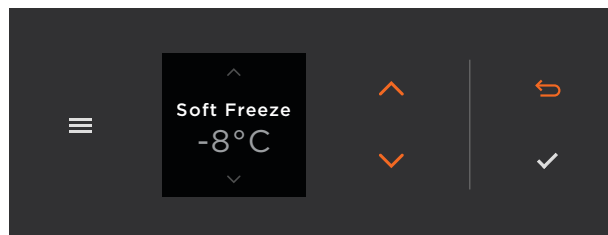

3. Press  $\nabla$  or  $\blacktriangle$  to adjust the temperature, and press  $\checkmark$  to confirm.

Press  $\leftarrow$  at any point to exit the menu.

## USING THE ICE MAKER

The ice maker produces ice directly into the storage bin and automatically makes more to replace what you use. Keep the ice cubes level in the bin to maximise storage space.

The filter should be flushed before you first use the ice. To flush, discard the first full bin of ice as it may be discoloured.

It may take several hours to begin producing ice.

### Turn your ice maker off if:

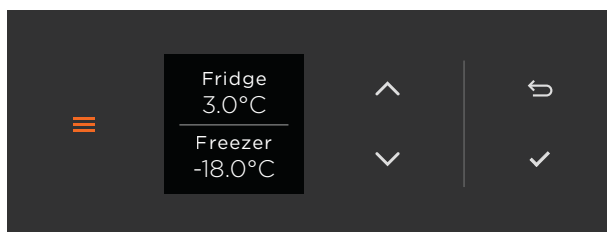

- There is no water supply for several hours.
- You are removing the ice storage bin for a long period of time.
- You are going on holiday.

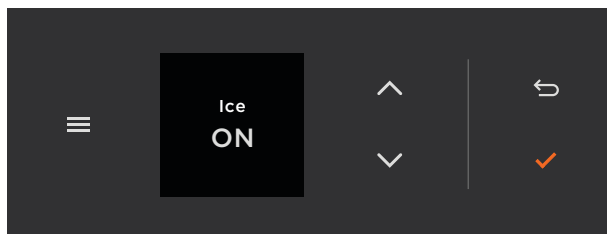

### Turning ice maker on or off

1. Press  to access the menu.



2. Press  or  to scroll to ICE, then press  to turn the ice maker on or off.



### Making extra ice

Remove the storage bin and allow ice to fall into the larger bin.

You can turn on **ICE BOOST** to make extra ice for up to 24 hours. Turn **ICE BOOST** on or off via the menu.

## WI-FI CONNECTION

Your appliance may be connected to your home wireless network and operated remotely using the app.

### Getting started





- Ensure your home Wi-Fi network and Bluetooth on your mobile device are turned on.
- You will be given step-by-step guidance on mobile device.
- It may take up to 10 minutes to connect your appliance.

### On your mobile device:

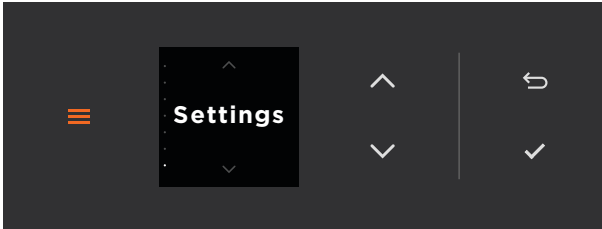

- ① Download the app from [www.fisherpaykel.com/connect](http://www.fisherpaykel.com/connect)
- ② Register and create an account.
- ③ Add your appliance and set up the Wi-Fi connection.

### Connecting to Wi-Fi

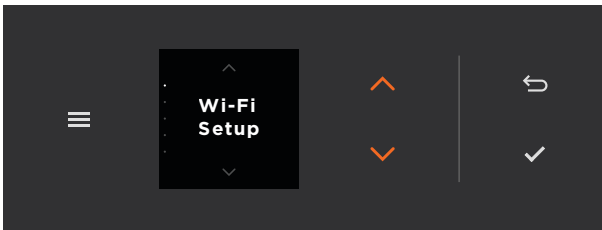

1. Press  to access the menu, then  or  to scroll to **SETTINGS**. Press  to select.



2. Press  or  to scroll to **WI-FI SETUP**. Press  to select.

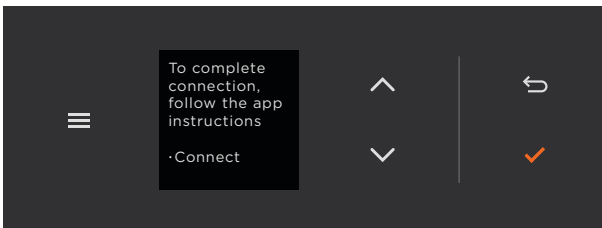



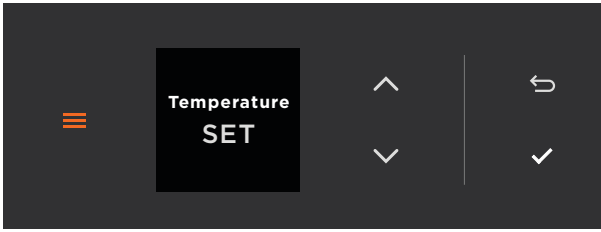

3. Follow the prompts on the display and in the app to complete setup.

## ACCESSING THE MENU

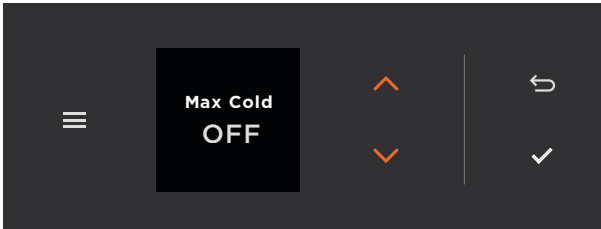

1. Press  to access the menu.



2. Press  or  to scroll to the desired feature and press  to select.

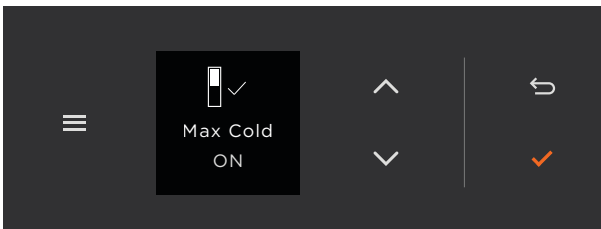

3. Adjust as needed and press  to confirm.

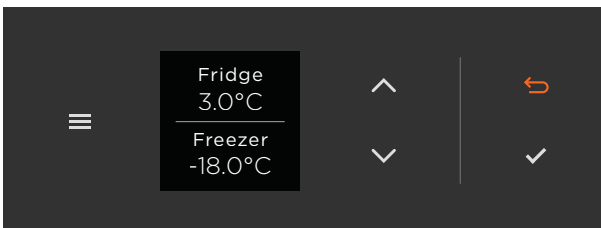

4. Press  at any point to exit the menu.

## CLEANING

### Surfaces, shelves and racks

Remove racks, then wipe interior surfaces with a damp cloth and mild detergent. Dry with a clean, lint-free cloth. Use a small brush to clean difficult to reach spots if needed.

We do not recommend using the following cleaning products as they may cause damage:

- Plastic or stainless steel scouring pads
- Abrasive, solvent, household cleaners
- Acid or alkaline cleaners
- Hand washing liquids or soap
- Stainless steel cleaners or polishes
- Laundry detergents or disinfectants

### Door seal

Use a small brush to clean around the door seal as needed.

### Toe kick grilles

We recommend cleaning the grille every 6 months, and regularly vacuuming the floor in front of your appliance to keep ventilation openings clear.

### Bins

Bins can be removed for cleaning. Wipe clean with a damp cloth and mild detergent, then dry with a clean, lint-free cloth.

### Water filter

Replace the water filter when alerted. To fit replacement filter, follow instructions supplied with new filter. Once new filter is fitted, dispense eight litres to flush it, and go to **SETTINGS** to reset the water filter timer.

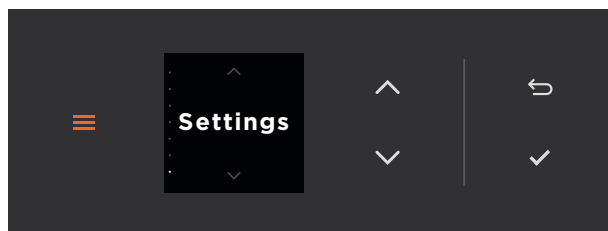

1. Press **☰** to access the menu, then **▼** or **▲** to scroll to **SETTINGS**. Press **✓** to select.

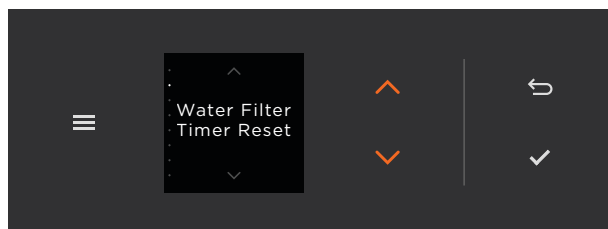

2. Press **▼** or **▲** to scroll to **WATER FILTER TIMER RESET**. Press **✓** to select and again to confirm.

## CLEANING

---



### Removing the fixed shelf

Pull the shelf towards you to release the clips, then lift up to remove.

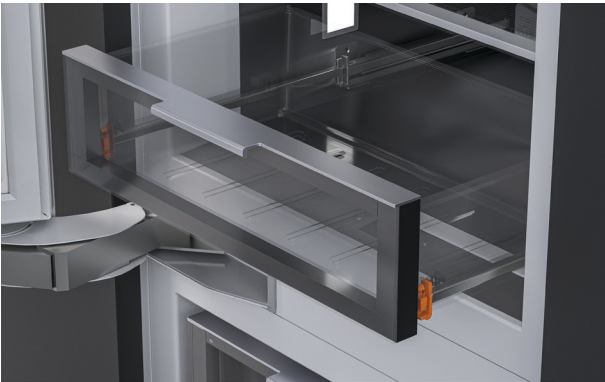

### Removing fridge bins

1. Pull the bin towards you, and push in tabs on either side to release bin from runners.

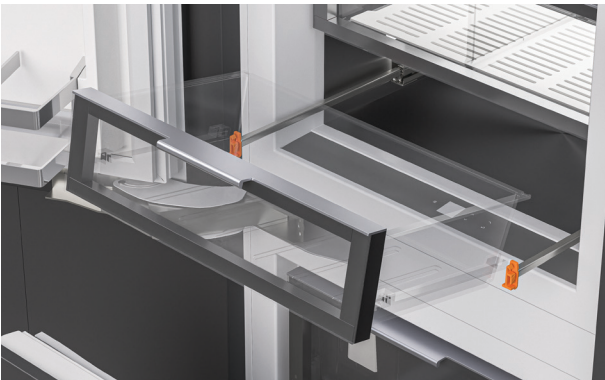

2. To refit, extend the runners and place the bin on top. Slowly push bin onto tabs until you feel them clip into place.



### Removing upper freezer bin

1. Pull the bin towards you, and push in tabs on either side to release bin from runners.

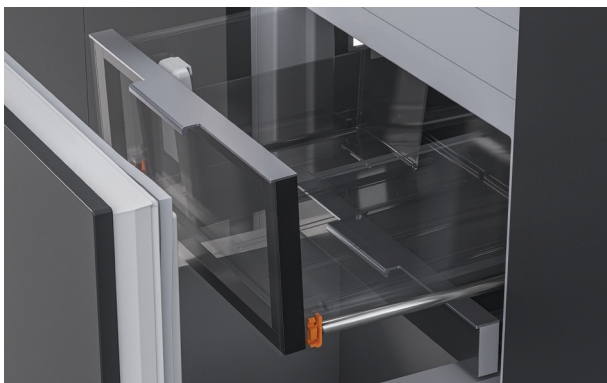

2. To refit, extend the runners and place the bin on top. Slowly push bin onto tabs until you feel them clip into place.



## CLEANING

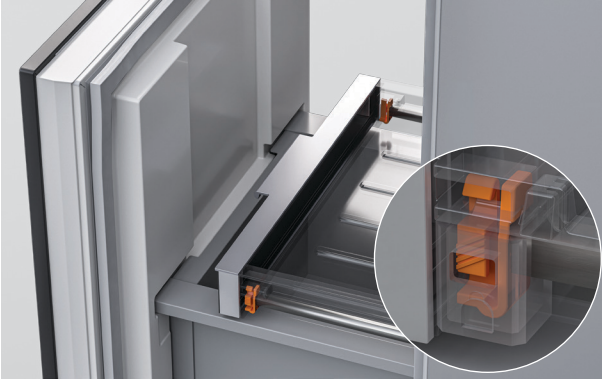

### Removing lower freezer bin

1. Open the bin fully and unclip the tray from the sliders, then remove the tray and push sliders back in.

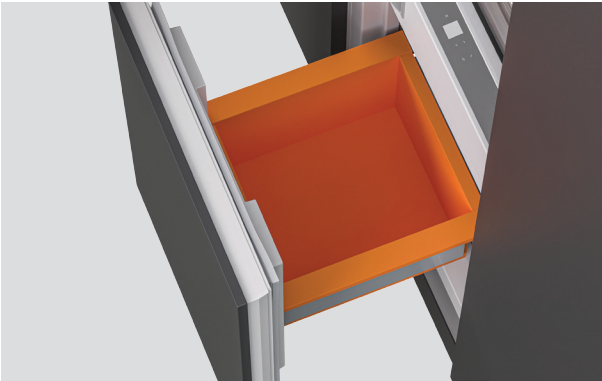

2. Lift the bin slightly and slide it back inside the freezer to separate it from the supports. We recommend wearing gloves as the bin will be cold.

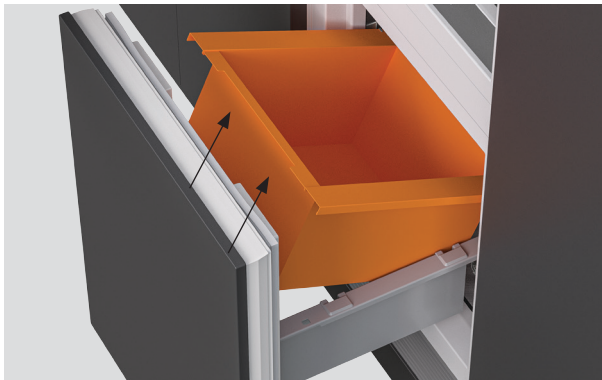

3. Tilt the bin towards the freezer, then lift to remove.

## CLEANING

---

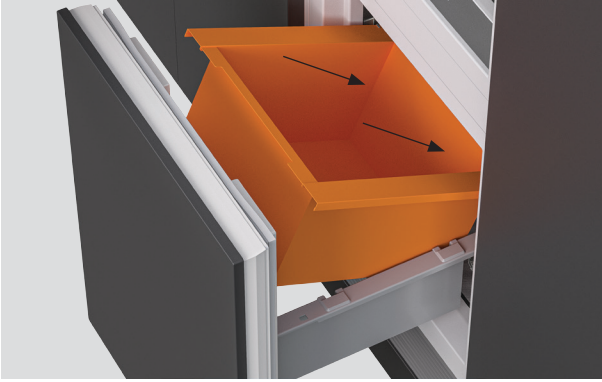

4. To refit, tilt the bin to place it back into the freezer, then lower the front until it sits on the supports. Pull it towards you slightly until it fits into place.

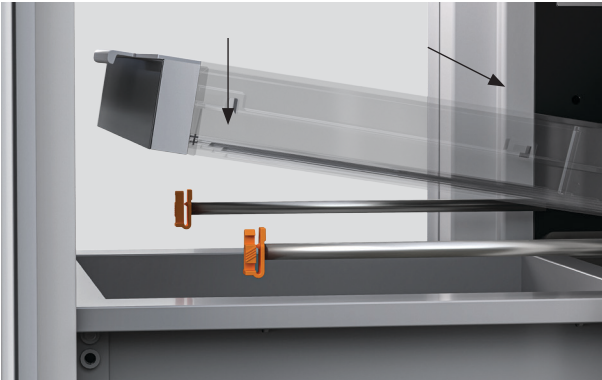

5. To refit the tray, extend the sliders and place the rear of the tray onto them. Clip the tray to the sliders to secure.

## TROUBLESHOOTING

---

### General use

---

#### Why will the product not turn on?

- No power. Make sure the product is connected to the power supply and switched on at the wall.
  - Check the circuit breaker, or check if there is a power cut in your home or area. If the product still won't turn on, call Customer Care or your Authorised Service Centre.
- 

#### Why is the display not working?

- The product may be in Sabbath Mode. Press and hold  to exit this mode.
- 

#### Why is the light not working?

- Product is not switched on. Check it is turned on at the wall or the isolating switch.
  - Light needs to be replaced. Call Customer Care or your Authorised Service Centre.
- 

#### Why is the product beeping and displaying a code when I open the door?

- There is a fault. Record the code on the display, and call Customer Care or your Authorised Service Centre.
- 

#### Why are the storage compartments too warm?

- Temperature setting not correct. See 'Selecting and adjusting modes and temperatures.'
  - Frequent door openings. Minimise door openings to allow temperature to stabilise.
  - Large number of beverages have been recently added. Take care not to overfill.
- 

#### Why is the product making unfamiliar noises?

- Product is not stable or level. Check Installation guide at [www.fisherpaykel.com](http://www.fisherpaykel.com) or call Customer Care or your Authorised Service Centre.
  - Freezer is defrosting. This is normal.
- 

#### Why is the product warm on the outside?

- This is normal.
- 

#### Why is food freezing in the refrigerator?

- Temperature setting needs to be increased. Refer to 'Adjusting the temperature' and 'Food modes'.
-

## TROUBLESHOOTING

---

---

### Why can I not select Food Mode?

- Not all food modes are available in all compartments. Refer to 'Food mode presets' for available food mode combinations.
- 

### Why is there water in the vegetable bins?

- Fruit and vegetables can generate moisture and create condensation. Some condensation is beneficial when storing fruit and vegetables. Wipe out excess water with a cloth.
- 

### Why does the bin not slide in and out smoothly/fully?

- Packaging is trapped. Check to ensure nothing is trapped behind the tray/bin.
  - Runners not regularly extended. Pull them out to restore full extension. Do not remove the grease from the runners.
- 

### Why is there condensation/ice in the compartment?

- This is normal during periods of high humidity. Wipe dry with a lint-free cloth.
  - Frequent or too long door openings. Minimise door openings.
  - Door gasket is leaking. Check and clean the door gasket seal.
  - Door not closing tightly. Rearrange items so door can close.
  - Doors not aligned. Call Customer Care or your Authorised Service Centre.
- 

### Why is there condensation on the outside of the product?

- This is normal during periods of high humidity. Wipe dry with a lint-free cloth.
- 

### Why is the door not closing?

- Items in the product are preventing door from closing tightly. Rearrange items so door can close.
  - Product is not installed correctly. Check Installation guide at [www.fisherpaykel.com](http://www.fisherpaykel.com) or call Customer Care or your Authorised Service Centre.
- 

### Why are the ice cubes so large/small?

- Blocked water filter. Change filter before calling technicians.
  - Water line is kinked or squashed. Unkink the external water line. If not kinked or squashed, call Customer Care or your Authorised Service Centre.
- 

### Why is the freezer door not opening?

- The door has recently been opened. Wait 30 seconds and try again.
-

## TROUBLESHOOTING

---

### Why are frozen food items soft or melting?

- Temperature setting needs to be adjusted. Refer to 'Food modes'.
  - Remove items and place in another freezer or cooler, and call Customer Care or your Authorised Service Centre.
- 

### Why is the ice maker not working?

- Ice maker not turned on. Switch ice maker on. Refer to 'Changing features.'
  - Water supply turned off or not connected. Connect the water supply.
  - Water pressure too low. Check water pressure.
  - Water line kinked or squashed. Check water line.
  - Filter is clogged. Replace water filter.
  - Ice cubes are clumped in the bin. Remove ice storage bin, loosen cubes and remove clumped ice. Refit ice storage bin.
  - Freezer compartment now working. Call Customer Care or your Authorised Service Centre.
- 

### Why do the ice cubes taste tainted?

- Unsealed foods may be emitting an odour. Wrap or cover strong smelling foods, discard ice cubes and clean ice storage bin. Refer to 'Interior cleaning'.
  - Poor taste from incoming water. Replace filter cartridge. Parts and accessories can be purchased through our Customer Care Centre.
- 

### Why are the ice cubes freezing slowly?

- The door may have been left open. Close the door.
  - Freezer compartment is set too warm. Turn temperature to a colder setting. Refer to 'Adjusting the temperature'.
- 

### Why is the ice wet/clumping?

- Ice will stick together over time. Tap to unstick.
  - Freezer door open for long periods.
  - High ambient temperature.
  - Ice bin has been left out of the freezer. Gently tap ice to unstick it or empty ice bin and make new ice.
  - The filter is blocked. Replace the filter cartridge.
- 

### Why is the ice discoloured?

- The water filter has not been flushed. Refer to installation guide for details on how to flush your water filter.
-

## FAULTS

---

If a fault occurs, there will be 4 rapid beeps and the fault will be displayed on the control panel.

Record the fault code and contact a Fisher & Paykel trained and supported service technician in order to repair the fault. You can do this by going online to [fisherpaykel.com](http://fisherpaykel.com) or by contacting our Customer Care Centre.

### Normal appliance sounds

This product has been designed to have excellent energy ratings and cooling performance. As a result, it can produce sounds somewhat different to your old appliance.

---

<b>Low frequency ticking</b>	This is the valve that controls cooling to each compartment. This noise will only last for a few seconds at a time.
<b>Fan air flow</b>	This product has fans which change speed depending on demand. During cooling periods, such as after frequent door openings, fans circulate the cold air in the appliance producing some air-flow sound. This is quite normal.
<b>Cracking or popping</b>	This may occur when the automatic defrost function is operating.
<b>Running water</b>	This is the liquid refrigerant in the system and can be heard as a boiling or gurgling noise.
<b>Hissing sound after closing the door</b>	This is due to the pressure difference between the warm air that has entered the product, and suddenly cooled, and the outside air pressure.
<b>Humming</b>	This is the compressor running and is quite normal.
<b>Ice maker noises</b>	Motor operation (low humming). Running water as the ice maker and/or water tank fills. Water valve opening and closing (hissing sound). Loosened from the ice molding tray (cracking). Ice dropping into bin (clunking).
<b>Other sounds</b>	Product is not stable or level. Bottles or jars rattling on shelves.

---

## MANUFACTURER'S WARRANTY AND SERVICE GUIDE

---



### **To access your Warranty and Service Guide**

Scan the QR code with your smartphone to access your warranty and book a service, refer to your separate warranty and service book or view online at:

#### **New Zealand**

<https://www.fisherpaykel.com/nz/help-and-support/warranty-information>

#### **Australia**

<https://www.fisherpaykel.com/au/help-and-support/warranty-information>

This product has been designed for use in a domestic (residential) environment. This product is not designed for any commercial use. Any commercial use by the customer will affect this products Manufacturer's Warranty.

For spare parts, please contact Fisher & Paykel Customer Care. Spare parts are available for all Fisher & Paykel products for a minimum period of 10 years from the date of manufacture.

## CUSTOMER CARE

---

### **Before you call for service or assistance**

Check the things you can do yourself. Refer to your User guide and check:

- ① Your product is correctly installed.
- ② You are familiar with its normal operation.
- ③ You have read the 'Before you call for service or assistance', 'Faults' and 'Troubleshooting'.

If, after checking these points, you still need assistance or parts, please refer to your nearest Paykel trained and supported service technician, Customer Care, or contact us through our website [fisherpaykel.com](http://fisherpaykel.com).

### **In NZ if you need assistance**

Call the Fisher & Paykel Customer Care Centre and talk to one of our Customer Care Consultants.

**Toll Free:** 0800 372 273

**Website:** [fisherpaykel.com](http://fisherpaykel.com)

#### **Postal address:**

Fisher & Paykel Appliances New Zealand  
PO BOX 58546  
Botany  
Auckland

### **In Australia if you need assistance**

Call the Fisher & Paykel Customer Care Centre and talk to one of our Customer Care Consultants.

**Toll Free:** 1300 650 590

**Website:** [fisherpaykel.com](http://fisherpaykel.com)

#### **Postal address:**

Fisher & Paykel Appliances Australia  
Level 1  
1 Eden Park Drive  
Macquarie Park  
NSW 2113

### **If you need service**

Fisher & Paykel has a network of Fisher & Paykel trained and supported service technicians that can carry out any service necessary on your appliance. Our Customer Care Centre can recommend a Fisher & Paykel trained and supported service technician in your area, or you can book one online at [fisherpaykel.com](http://fisherpaykel.com).

If you call, write or contact us via our website please provide:

your name and address, model number, serial number, date of purchase and a complete description of the problem. This information is needed in order to better respond to your request for assistance.

**Product details can be found inside the product at the bottom right.**



## CUSTOMER CARE

---

Complete and keep for safe reference:

Model \_\_\_\_\_

Serial No. \_\_\_\_\_

Purchase Date \_\_\_\_\_

Purchaser \_\_\_\_\_

Dealer \_\_\_\_\_

Suburb \_\_\_\_\_

Town \_\_\_\_\_

Country \_\_\_\_\_

**FISHERPAYKEL.COM**

© Fisher & Paykel Appliances 2024. All rights reserved.

The models shown in this guide may not be available in all markets  
and are subject to change at any time.

The product specifications in this guide apply to the specific products and  
models described at the date of issue. Under our policy of continuous product  
improvement, these specifications may change at any time.

For current details about model and specification availability in your country,  
please go to our website or contact your local Fisher & Paykel dealer.

**432655A 12.24**