

Series 7, Contemporary Built-under Dishwasher

Series 7 | Contemporary

Black Stainless Steel

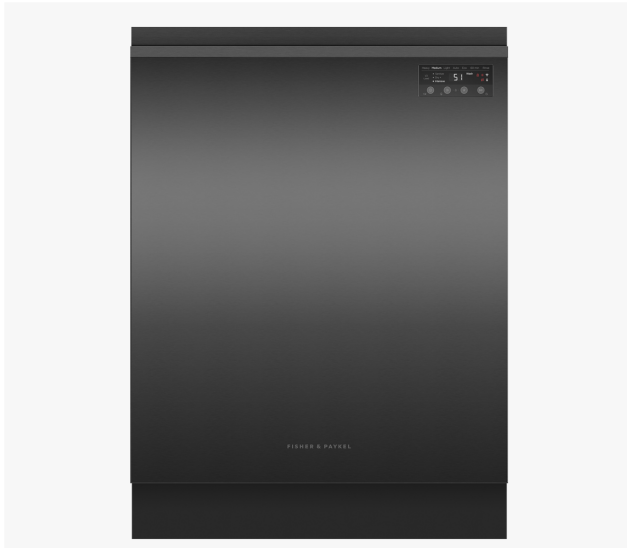

Offering a superior wash performance and advanced drying, this dishwasher is designed to fit flush under your benchtop for a seamless look.

- Designed to be built under your benchtop, fitting flush with cabinetry for a seamless look
- Seven wash programs from Heavy to Light, including Auto, 60min and Eco
- Dry+, Sanitise, Half Load and Intensive modifiers provide extra wash options

- Wi-Fi enabled and works with the SmartHQ™ app for remote control and notifications

DIMENSIONS

Height	820 - 880 mm
Width	597 mm
Depth	574 mm

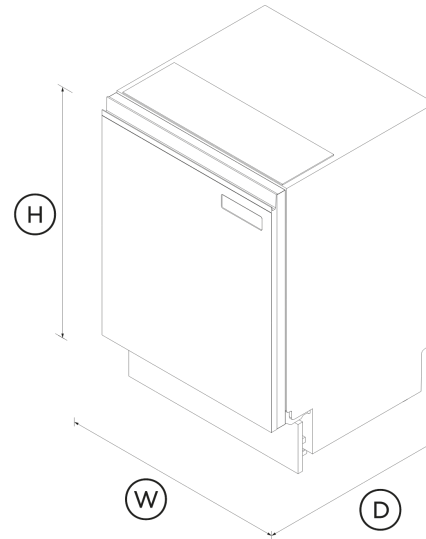

FEATURES & BENEFITS

Seamless Design

Install this dishwasher flush under your benchtop with minimal gaps. Designed to match our Contemporary family of appliances with a recessed handle for a seamless finish in your kitchen.

Advanced Drying

For beautifully dry dishes every time, this dishwasher features an advanced drying system. It combines fan-assisted drying with an automatic door opening at the cycle's end. The Auto Door Open Dry feature releases excess steam, ensuring dishes are immediately ready for use or storage. An innovative air curtain channels the steam away from the adjacent benchtop, protecting your cabinetry.

A Reliable Clean

This dishwasher offers seven wash programs including Auto, which automatically senses the optimal wash settings for your dishes. The three-stage filtration system delivers a superior clean, while the rinse aid indicator reminds you to top up for beautifully clean dishes.

Customise Your Wash

Create the perfect wash with our range of modifiers, from Intensive for a thorough clean to Half Load, ideal for a partial load. The Sanitise modifier provides extra protection, killing 99.9% of bacteria* in the final rinse, while Dry+ is great for plastic dishes.

*Certified to NSF/ANSI Standard 184

Quiet Performer

Running at a very low decibel rating, this dishwasher does its job without making a fuss. The combination of clever technology and simple mechanics means greater reliability and superior wash performance, with minimal noise.

Efficient Performance

With a 4.5 star energy rating and 5.5 star water rating, this dishwasher delivers a powerful wash. Use the Eco wash program for optimal water and energy consumption, or choose when the cycle begins with Delay Start.

Flexible Loading

Designed to fit 15 place settings, this spacious model lets you stack large items with ease. Adjustable rack options provide flexibility for any load, with a full-width cutlery tray, height-adjustable middle rack, cup holders and wine glass supports.

SPECIFICATIONS

Accessories (included)

Cutlery basket	•
Kickstrip	true

Capacity and loading

Accommodates round plates up to (lower basket)	320mm
Accommodates round plates up to (top basket)	200mm (with cutlery tray), 250mm (cutlery tray removed)
Adjustable height, foldable cupracks	•
Easy lift adjustable upper basket	•
Fold down tines	•
Full width cutlery/utensil tray	•
Large crockery insert in lower basket	•
Place settings	15
Place settings	15
Wine glass supports with stemware grippers	•

Consumption

Energy rating	4.5 star
Energy usage	206 kWh/year
In-use energy carbon emissions estimate	27.9kgCO2e/year

Water consumption (per wash cycle)	11.1L
Water rating	5.5 star (WELS)

Controls

Energy saving delay start option of up to 12 hours	•
Internal light	•
Intuitive capacitive touch controls	•
Keylock	•
Rinse aid indicator light	•
Smart appliance	•
Time remaining LED display	•

Features

Air curtain for bench protection	•
Aquastop	•
Auto Door Open Dry	•
Fan assisted drying	•
Flood protection	•
Fully independent spray arms	•
Half load option	•
Internal tub material	Stainless Steel
Motor type	BLDC
Three-stage filtration system	•

Performance

Noise emissions	42 dBA
-----------------	---------------

Power requirements

Amperage	10A
Supply frequency	50Hz
Supply voltage	220 - 240V

Product dimensions

Depth	574 mm
Height	820 - 880 mm
Width	597 mm

Warranty

Parts and labour	2 years
------------------	----------------

Wash Program Modifiers

Dry +	•
Half load	•
Intensive	•
Sanitise	•
Wash modifiers	4

Wash Programs

60 min	•
Auto	•
Eco	•
Heavy	•
Light	•
Medium	•

Rinse	•
Wash programs	7

Water connection

Water pressure	30kPa - 1000 kPa
Water supply	3/4" BSP (20mm) Connector Water Inlet Hose

SKU	82435
-----	-------

The product dimensions and specifications in this page apply to the specific product and model. Under our policy of continuous improvement, these dimensions and specifications may change at any time. You should therefore check with Fisher & Paykel's Customer Care Centre to ensure this page correctly describes the model currently available. © Fisher & Paykel Appliances Ltd 2020

All appliances use energy, and energy usage typically generates carbon emissions. **Fisher & Paykel Appliances' In-use Energy Carbon Emissions Estimate** indicates carbon emissions from a product's in-use energy. This is calculated either annually or per cycle, using the product's market-specific energy label energy consumption data multiplied by the carbon emissions factor for energy in your country or region.

Our In-use Energy Carbon Emissions Estimate is designed to assist customers in making informed purchasing decisions when comparing different Fisher & Paykel products. For example, a heat pump dryer typically has a lower In-use Energy Carbon Emissions Estimate than a vented dryer.



A PEACE OF MIND SALE
24 Hours 7 Days a Week Customer Support

T 0800 372 273 [Wwww.fisherpaykel.com](http://www.fisherpaykel.com)

Other product downloads available at fisherpaykel.com

- [↓ 2D-DWG Dishwasher](#)
- [↓ 2D-DXF Dishwasher](#)
- [↓ Data Sheet Dishwasher](#)
- [↓ Energy & Water Label Built-Under Dishwasher](#)
- [↓ Service & Warranty](#)
- [↓ Installation Guide Built-Under Dishwasher](#)
- [↓ Preliminary Specification Guide Dishwasher](#)
- [↓ User Guide Dishwasher](#)
- [↓ Wash Program Data Dishwasher](#)

Where applicable: