

# **FISHER & PAYKEL**

## **DISHWASHER**

---

### **CONTEMPORARY**

DW60FC4X2, DW60UC4X2, DW60UN4X2,  
DW60FC4X3, DW60FC4B2 & DW60UN4B2  
models

**USER GUIDE**  
**NZ AU SG**



## CONTENTS

---

|   |    |
|---|----|
| Safety and warnings                       | 5  |
| First use                                 | 8  |
| Loading suggestions                       | 11 |
| Wash programs                             | 12 |
| Wash modifiers                            | 13 |
| Setting a wash                            | 14 |
| Wi-Fi connection & remote mode            | 16 |
| Delayed start                             | 17 |
| Keylock                                   | 18 |
| Sanitize                                  | 19 |
| Preferences                               | 20 |
| Detergent                                 | 22 |
| Rinse aid                                 | 24 |
| Racking features                          | 25 |
| Maintenance                               | 27 |
| Troubleshooting                           | 31 |
| Fault codes                               | 35 |
| Manufacturer's Warranty and Service guide | 37 |
| Customer care                             | 38 |

---

### Registration

To register your product visit our website: [fisherpaykel.com/register](https://fisherpaykel.com/register)



## SAFETY AND WARNINGS

---

### READ AND SAVE THIS GUIDE

When using your Dishwasher, follow basic precautions, including the following:

#### General

- The information in this guide must be followed to minimise the risk of fire or explosion or to prevent property damage, personal injury or loss of life.
- Use the Dishwasher only for its intended function as described in this guide.
- This appliance is intended to be used in household and similar applications such as:
  - staff kitchen areas in shops, offices and other working environments
  - farm houses
  - by clients in hotels, motels and other residential environments
  - bed and breakfast environments.
- NSF 184-Certified residential dishwashers are not intended for licensed food establishments.
- Use only detergents or rinse aid recommended for use in a domestic dishwasher and keep them out of reach of children. Check that the detergent dispenser is empty after the completion of each wash program.
- When loading items to be washed, locate sharp items so that they are not likely to damage the Dishwasher and load sharp knives with the handle up to reduce the risk of cut injuries.
- Do not touch the filter plate in the Dishwasher base during or immediately after use, as it may be hot.
- Do not operate your Dishwasher unless all enclosure panels are properly in place.
- Do not tamper with the controls.
- Do not abuse, sit on, stand in or on the door or dish rack of the Dishwasher.
- The door should not be left in the open position since this could present a tripping hazard.
- The foldaway cup racks are designed to support cups, glasses and kitchen utensils. Do not lean on or use the foldaway cup racks to support your body weight.
- To reduce the risk of injury, do not allow children to play in or on the Dishwasher.
- Under certain conditions, hydrogen gas may be produced in a hot water heater system that has not been used for two weeks or more. **HYDROGEN GAS IS EXPLOSIVE.** If the hot water system has not been used for such a period, before using the Dishwasher, turn on all hot water taps and let the water flow from each for several minutes. This will release any accumulated hydrogen gas. As the gas is flammable, do not smoke or use an open flame during this time.
- Remove the door to the washing compartment when removing an old Dishwasher from service or discarding it.
- Some dishwasher detergents are strongly alkaline. They can be extremely dangerous if swallowed. Avoid contact with the skin and eyes and keep children away from the Dishwasher when the door is open.
- The Dishwasher must be used with the filter plate, filter, and spray arms in place. To identify what these parts are refer to 'Maintenance'.
- If the Dishwasher is not being used for long periods of time, turn the electricity and water supply off.
- Cleaning and maintenance shall not be done by children without supervision.
- Take care not to load dishware items so they prevent the door from closing.

## SAFETY AND WARNINGS

---

- Household appliances are not intended to be used by children. Children of less than 8 years old must be kept away from the appliance unless continuously supervised. This appliance can be used by children aged from 8 years and above, and persons with reduced physical, sensory or mental capabilities or lack of experience and knowledge, if they have been given supervision or instruction concerning the use of the appliance in a safe way and they understand the hazards involved.
- If a dishwasher cleaner is used, we recommend running a wash program with detergent immediately afterward to prevent any damage.
- The Dishwasher is designed for washing normal household utensils. Items that are contaminated by petrol, paint, steel, iron debris, corrosive, acidic or alkaline chemicals are not to be washed in the Dishwasher.
- Do not wash plastic items unless they are marked dishwasher safe or equivalent. For plastic items not marked, check the manufacturer's recommendations.
- Avoid washing containers with glued on labels. Labels removed during a wash cycle may cause damage to the wash system.

### Installation

- This Dishwasher must be installed and located in accordance with the Installation instructions before it is used. If you did not receive Installation instructions with your Dishwasher, you can order them by calling your Authorised Repairer or download them from our local Fisher & Paykel website, listed on the back cover.
- Installation and service must be performed by a Fisher & Paykel trained and supported service technician.
- If the power supply cord is damaged, it must be replaced by a Fisher & Paykel trained and supported service technician or a qualified trades person in order to avoid a hazard.
- Ensure the Dishwasher is secured to adjacent cabinetry using the brackets provided. Failure to do so may result in an unstable product, which may cause damage or injury.
- Do not operate this appliance if it is damaged, malfunctioning, partially disassembled or has missing or broken parts, including a damaged power supply cord or plug.
- Do not store or use petrol, or other flammable vapours and liquids in the vicinity of the Dishwasher.
- Connect to a properly rated, protected and sized power supply circuit to avoid electrical overload.
- Ensure the power supply cord is located so that it will not be stepped on, tripped over or otherwise subject to damage or stress.
- Do not install or store the Dishwasher where it will be exposed to temperatures below freezing or exposed to weather.
- Do not use an extension cord or a portable electrical outlet device (e.g. multi-socket outlet box) to connect the Dishwasher to the power supply.
- This appliance must be grounded. In the event of a malfunction or breakdown, grounding will reduce the risk of electric shock by providing a path of least resistance for electric current.
- This appliance is equipped with a cord having an equipment-grounding conductor and a grounding plug. The plug must be plugged into an appropriate outlet that is installed and grounded in accordance with all local codes and ordinances. Improper connection of the equipment-grounding conductor can result in a risk of electric shock. Check with a qualified electrician or Fisher & Paykel trained and supported service technician if you are in doubt as to whether the appliance is properly grounded.

## SAFETY AND WARNINGS

---

- Do not modify the plug provided with the appliance; if it will not fit the outlet, contact a Fisher & Paykel trained and supported service technician or qualified electrician.
- If the Dishwasher is installed as a permanently connected appliance, this appliance must be connected to a grounded metal, permanent wiring system, or an equipment-grounding conductor must be run with the circuit conductors and connected to the equipment-grounding terminal or lead on the appliance.

### Maintenance

- Disconnect the appliance from the power supply before any cleaning or maintenance.
- When disconnecting the appliance pull the plug rather than the power supply cord or junction of cord to avoid damage.
- Do not repair or replace any part of the appliance or attempt any servicing unless specifically recommended in this guide. We recommend contacting a Fisher & Paykel trained and supported service technician or Customer Care.
- Keep the floor around your appliance clean and dry to reduce the possibility of slipping.
- Keep the area around/underneath your appliance free from the accumulation of combustible materials, such as lint, paper, rags and chemicals.

### Wi-Fi

- Do not change or modify the wireless communication device in any way. Changes or modifications not expressly approved by Fisher & Paykel could void the user's authority to operate the equipment.

## FIRST USE

---

- Ensure the installer has completed the 'Final checklist' in the Installation instructions.
- Read this guide, taking special note of the 'Safety and warnings' section.
- Remove all internal and external packaging and dispose of it responsibly. Recycle items that you can.

### Dishwasher overview

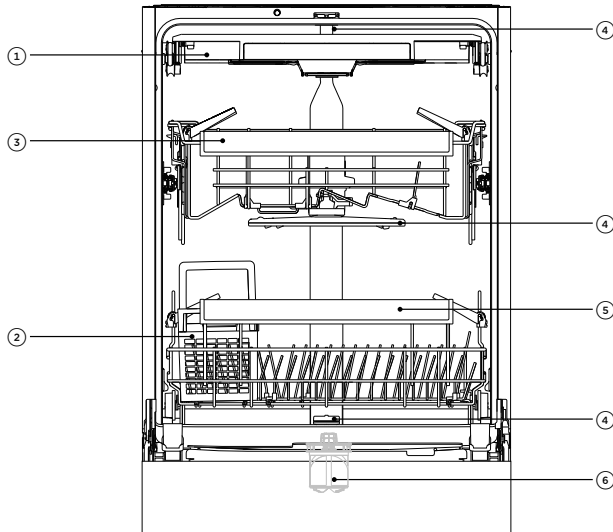

---

### Control panel features

---

- |                                    |                |
|------------------------------------|----------------|
| ① Cutlery/Utensil tray             | ④ Spray arms   |
| ② Cutlery basket                   | ⑤ Lower basket |
| ③ Upper basket (adjustable height) | ⑥ Filter       |

Not shown: control panel, detergent/rinse aid dispensers (located inside door).



## FIRST USE

### Control panel overview

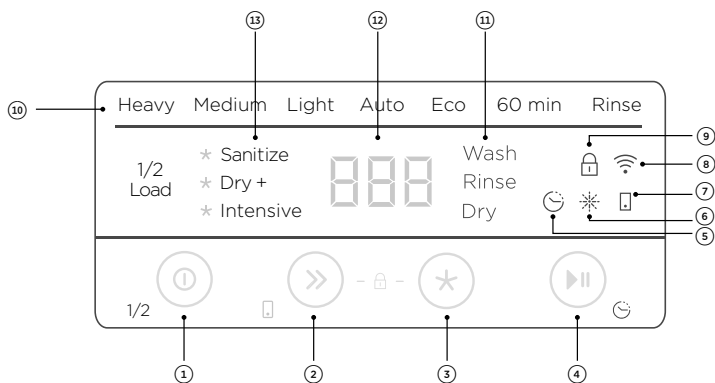

### Control panel features

- |                           |                            |
|---------------------------|----------------------------|
| ① On/Off + 1/2 load       | ⑧ Wi-Fi indicator          |
| ② Wash program selector   | ⑨ Key lock indicator       |
| ③ Wash modifier selector  | ⑩ Wash program indicators  |
| ④ Start + Delayed start   | ⑪ Wash stage indicators    |
| ⑤ Delayed start indicator | ⑫ Display                  |
| ⑥ Rinse aid indicator     | ⑬ Wash modifier indicators |
| ⑦ Remote mode indicator   |                            |

## FIRST USE

---

### Dishware

The combination of high temperatures and dishwasher detergent may cause damage to some items. Refer to the manufacturer's guidance or wash by hand if in doubt.

#### Cutlery & silverware

Rinse cutlery and silverware immediately after use to prevent tarnishing. We recommend using the **RINSE** cycle. Silver should not come into contact with stainless steel, mixing these can cause staining. Remove silver cutlery from the dishwasher and hand dry immediately.

#### Aluminium

Aluminium can be dulled by detergent. The degree of change depends on the quality of the detergent or aluminium.

#### Other metals

Iron and cast iron can rust and stain other items. Copper, pewter and brass tend to stain.

#### Woodware

Woodware is generally sensitive to heat and water. Regular use in the dishwasher may cause deterioration over time.

#### Glassware

Most glassware is dishwasher safe. Crystal, very fine and antique glassware may etch and develop a cloudy appearance.

#### Plastics

Some plastics may change shape or colour with hot water. Refer to the manufacturer's guide. Dishwasher safe plastic should be weighed down so it does not flip and fill with water or fall through the base rack during the wash.

#### Decorated items

Most modern china patterns are dishwasher safe. Antique items, those with a pattern painted over the glaze, gold rims or hand painted china may be more sensitive to machine washing.

#### Glued items

Certain adhesives are softened or dissolved in machine washing.

---

### Water hardness

Hard water is water with a high concentration of minerals such as calcium and magnesium. It can be detrimental to the performance of your dishwasher and parts can fail over time. Glassware washed in hard water will become cloudy over time and dishes will become spotted or covered in a white film. Water hardness varies by geographical location.

If you live in a hard water area, we recommend fitting a water softener to the household water supply.

#### If your home has hard water

- Refer to 'Powdered detergent quantity recommendations'.
- Use rinse aid. We recommend you raise the rinse aid setting to 6 to help improve wash performance. Refer to 'Preferences' for details.

Use a dishwasher cleaner/descaler regularly, or whenever you notice a build-up of limescale deposits in your dishwasher.

#### If your home has soft or softened water

- Avoid using too much detergent.

## LOADING SUGGESTIONS

---

When loading your Dishwasher ensure items are placed so water coming from the rotating spray arm below can reach all areas. Wash performance will be reduced if it can't.

Your dishwasher can hold up to a maximum of 15 place settings.

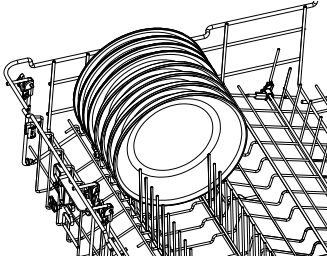

### Ensure

- Lower and middle spray arms can rotate freely.
- Tall items do not obstruct the upper spray arm.
- Glass and other fragile items are stable.
- All dish openings are facing downwards.
- Plates are evenly spaced.
- All sharp objects are located securely to avoid injury or damage to the product.

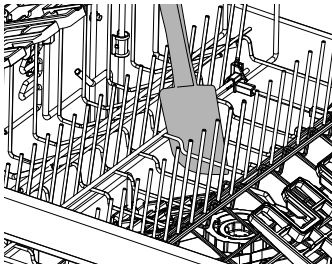

### Avoid

- Overcrowding.
- Any protrusions below the racks and basket that may prevent spray arm rotation.
- Any protrusions at the front of the dishwasher.
- Blocking water from any items on the foldaway cup racks.

## WASH PROGRAMS

Your dishwasher has a number of wash programs designed to suit your needs. Selecting the most appropriate cycle for each load will help ensure the best wash results.

| WASH PROGRAM  | PROGRAM DESCRIPTION   |
|---------------|---|
| HEAVY         | Designed for heavily soiled pots, pans and dishes   |
| MEDIUM        | Best for dishes that are quite heavily soiled or to remove food soils that have been left to dry overnight        |
| LIGHT         | For very lightly soiled dishes with easy to remove soils; no drying   |
| AUTO          | Suitable for any type of load. The dishwasher automatically selects the optimum wash program                      |
| ECO (default) | For normally soiled dishes for optimum water and energy usage   |
| 60MIN         | Use for dishes that are quite heavily soiled or food soils that have been left to dry overnight; no drying cycle. |
| RINSE         | Prevents odours and soils from drying on dishes   |

## WASH MODIFIERS

---

After setting a wash program, you can also select a wash modifier. Not all modifiers can be combined with all wash programs. 1/2 LOAD can be used in combination with the other modifiers.

### 1/2 LOAD

Adjusts the wash program to more efficiently wash smaller loads.

### SANITIZE

Raises the water temperature during the rinse phase to sanitize.

### DRY+

Increases the final rinse temperature and the length of the drying phase.

### INTENSIVE

Increases the water pressure in the lower rack for heavily soiled pots and pans.

| WASH PROGRAM  | MODIFIER AVAILABLE                  |
|---------------|-------------------------------------|
| HEAVY         | 1/2 LOAD, SANITIZE, DRY+, INTENSIVE |
| MEDIUM        | 1/2 LOAD, SANITIZE, DRY+, INTENSIVE |
| LIGHT         | 1/2 LOAD, DRY+                      |
| AUTO          | 1/2 LOAD, DRY+                      |
| ECO (default) | -                                   |
| 60MIN         | 1/2 LOAD, DRY+, INTENSIVE           |
| RINSE         | -                                   |

## SETTING A WASH

1

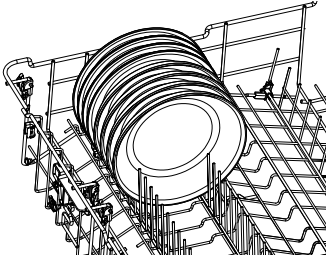

Remove all food scraps from dishware before carefully loading into the dishwasher. Ensure the spray arms are free from any obstructions and rotate freely.

2

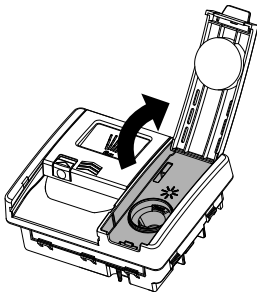

If rinse aid is required fill the rinse aid dispenser. Refer to 'Rinse aid' for additional guidance.

3

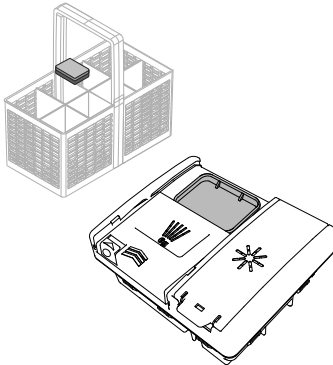

Add detergent to the dispenser and close the cover.

Tablets can be placed in the detergent dispenser or in the cutlery basket.

4

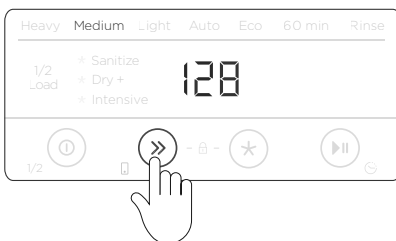

Press the power button to turn on the display, then select a wash.

## SETTING A WASH

5

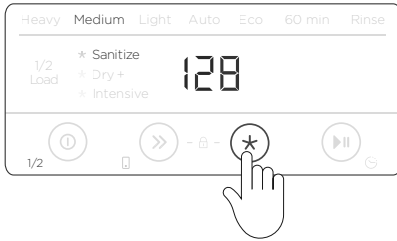

Select a wash modifier or 1/2 LOAD if required. Press ★ to select **SANITIZE**, **DRY+** or **INTENSIVE**.

6

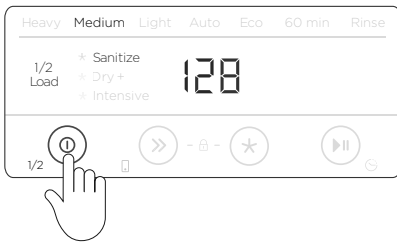

Press and hold for three seconds ① to select **1/2 LOAD**.

7



Press ▶▶ to start the wash.

Ensure the door is closed. If the door is not closed within 7 seconds the wash will be cancelled.

Press ▶▶ again at any point during the wash to pause.

8



Press and hold ① for two seconds to cancel the wash.

9

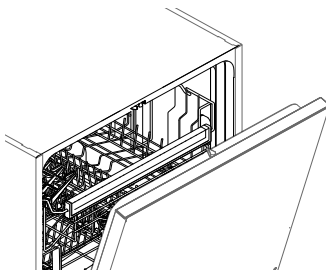

After the wash the door will automatically open slightly to assist with drying.\*

For best results, unload dishes once cooled.

\*This feature can be disabled, refer to 'Preferences'.

## WI-FI CONNECTION & REMOTE MODE

Your appliance may be connected to your home wireless network and operated remotely using the app.

### Getting started

- Ensure your home Wi-Fi network is turned on.
- You will be given step by step guidance on both your appliance and mobile device.
- It may take up to 10 minutes to connect your appliance.
- For further guidance and troubleshooting, please refer to the app.

### On your mobile device:

- ① Download the app from [www.fisherpaykel.com/connect](http://www.fisherpaykel.com/connect)
- ② Register and create an account.
- ③ Add your appliance and set up the Wi-Fi connection.

### Connecting to your home Wi-Fi

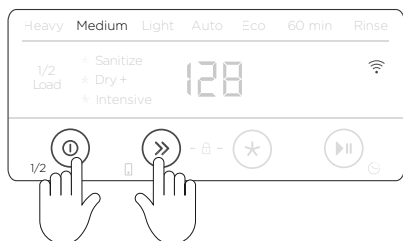

Ensure there is no wash in progress.  
Press and hold ① and >> together for 4 seconds.

When  flashes, follow the prompts in the app to complete set-up.

### Enabling remote mode

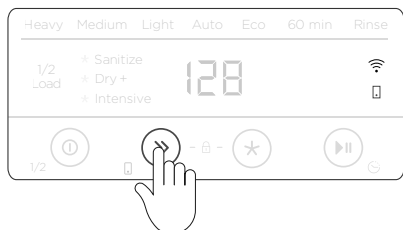

Ensure your Dishwasher is connected to your Wi-Fi network.

Press and hold >> for 4 seconds.



## DELAYED START

Set your dishwasher to start later in the day and run a selected wash program. **DELAYED START** can be set after a wash program has been selected and can be set for up to 12 hours.

### Setting Delayed Start

1



Add detergent and select a wash program, and wash modifier if required.

Press and hold ►|| to enter **DELAYED START**.

2

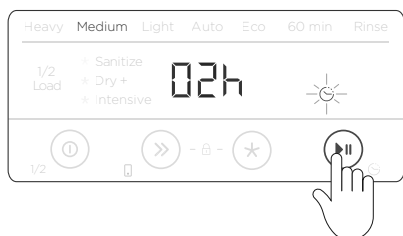

Press ►|| again to increase the delay time.

The wash program will begin at the end of the countdown, provided the door is closed.

### Cancelling Delayed Start



Press and hold ① to cancel delayed start.

## KEYLOCK

---

Lock the dishwasher controls for cleaning or to prevent unintended use. This can be set at any time including during a wash.

### Locking the controls

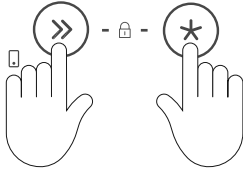

Press and hold » and ✳ together to lock.

### Unlocking the controls

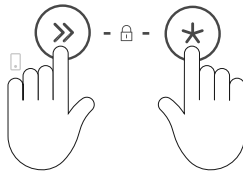

Press and hold » and ✳ together until the dishwasher unlocks.

# SANITIZE

## Using SANITIZE

The **SANITIZE** wash modifier adjusts the wash program to meet the conditions required by Section 6, NSF 184 for sanitization to occur. While **SANITIZE** is running, the wash program is monitored to ensure that these conditions are met.

Only programs utilising the **SANITIZE** wash modifier are certified to meet the conditions required by Section 6, NSF 184. Other wash programs may not reach the temperatures required for sanitization to occur. Refer to 'Wash modifiers' for wash programs that have sanitize available.

For sanitization to occur, the temperature of the water needs to reach 158°F (70°C). Ensure all items are dishwasher safe before running the sanitize modifier.

If the wash is interrupted or the water supply is turned off during the program, the heating conditions for sanitization may not be met. You may need to run the program again.

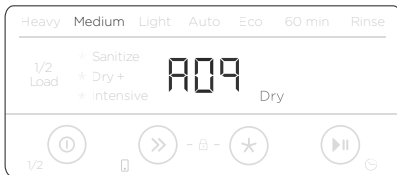

### If sanitization has been successful

The wash will finish as normal.

### If sanitization has not been successful

An alert will sound and a code will show on the display.

- ① Check if the water supply has been turned off or the wash program interrupted.
- ② Press and hold ① to stop the beeping, then again to clear the alert code.
- ③ Reset **SANITIZE** and run the cycle again

For more information, refer to 'Fault codes'.

## PREFERENCES

You can adjust any of the below settings prior to starting a wash cycle.

| OPTION                | DESCRIPTION   | DEFAULT    | SETTINGS DISPLAY |            |        |            |
|-----------------------|---|------------|------------------|------------|--------|------------|
| <b>Rinse aid</b>      | Controls the amount of rinse aid dispensed. Refer to 'Rinse aid' for further details.                             | <i>rR5</i> | Off              | <i>rR-</i> | Max: 6 | <i>rR6</i> |
| <b>Auto power-on</b>  | Your dishwasher is set to automatically power on for 30 seconds after the door is opened. This can be turned off. | <i>AP0</i> | On               | <i>AP0</i> | Off    | <i>AP-</i> |
| <b>Sound</b>          | Adjusts tone settings. When set to <b>OFF</b> all tones will be silenced except fault alerts.                     | <i>bP0</i> | On               | <i>bP0</i> | Off    | <i>bP-</i> |
| <b>Cavity light</b>   | Enables or disables the interior light.   | <i>LL0</i> | On               | <i>LL0</i> | Off    | <i>LL-</i> |
| <b>Auto door open</b> | Enables or disables automatic door opening at the end of the wash.  | <i>Ad0</i> | On               | <i>Ad0</i> | Off    | <i>Ad-</i> |

## PREFERENCES

### Changing the settings

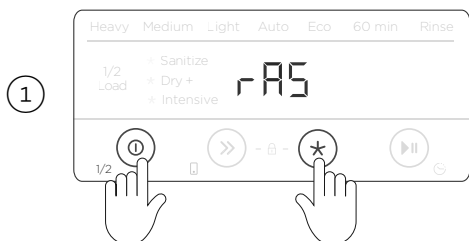

Ensure there is no wash in progress.  
Press and hold ⓘ and \* together for 4 seconds to enter the menu.

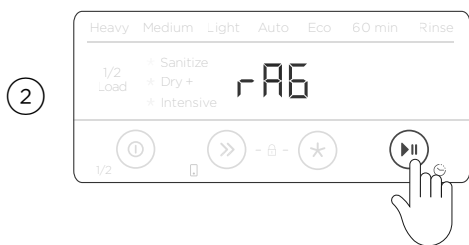

Press ▶|| to adjust the setting.

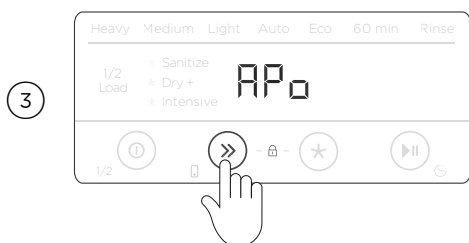

Press ▶▶ to scroll through the settings.

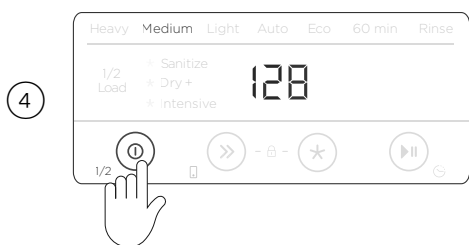

Press ⓘ to exit the menu and save your settings.

## DETERGENT

**WARNING:** Dishwasher detergents are strongly alkaline. They can be extremely dangerous if swallowed. Avoid contact with the skin and eyes and keep children and infirm persons away from the dishwasher when it is open. Check the powdered detergent dispenser is empty after each wash.

### Unsuitable detergents

These types of detergent are not suitable and may damage your dishwasher or lead to a service call that is not covered by warranty:

- Liquid detergents
- Laundry detergents
- Hand washing liquids
- Soaps
- Disinfectants

### Using powdered detergent

For powdered detergent quantities, refer to the following 'Powdered detergent quantity recommendations' table and the detergent manufacturer's guidance. No detergent is needed for **RINSE**.

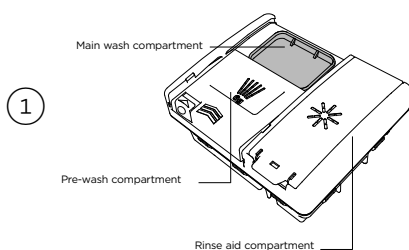

Check that the dispenser is empty and dry. Add powdered detergent or tablet to the detergent dispenser.

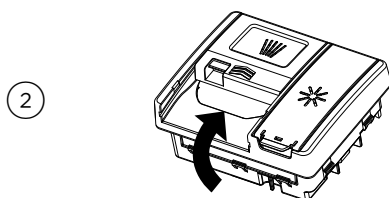

Remove any excess detergent then slide the cover closed. It will click into place.

If required, add additional detergent to the pre-wash compartment on top of the dispenser.

When washing heavily soiled dishware in hard water, more detergent may be required. Refer to 'Powdered detergent quantity recommendations'.

## DETERGENT

### Powdered detergent quantity recommendations

- Use the table below to determine the optimal powdered detergent quantity for each wash program.
- If you have hard water in your area, more detergent may be required. Refer to 'Water hardness' for more details

| WASH PROGRAM | PRE WASH COMPARTMENT | MAIN WASH COMPARTMENT |
|--------------|----------------------|-----------------------|
| AUTO         | None                 | 1/2-2/3               |
| HEAVY        | Full                 | 2/3                   |
| MEDIUM       | Full                 | 2/3                   |
| LIGHT*       | None                 | 1/2                   |
| ECO          | Full                 | 2/3                   |
| 60MIN        | Full                 | 1/2                   |
| RINSE        | n/a                  | n/a                   |

\*tablets are not recommended for the **LIGHT** cycle.

## RINSE AID

Rinse aid provides a streak-free finish to glass and dishware as well as preventing metal from tarnishing. We recommend using a liquid rinse aid regularly for optimal drying results. The rinse aid dispenser is located on the inside of the door next to the detergent dispenser.

### Using rinse aid

The amount of rinse aid dispensed in each wash may need to be adjusted to suit your water conditions. Refer to 'Preferences' and 'Water hardness' for guidance. Rinse aid is not required if tablet has it already built into it.

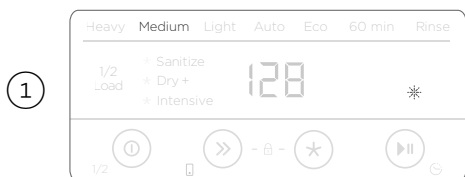

When the rinse aid level is low, the rinse aid indicator on the control panel will light up to remind you to refill the dispenser.

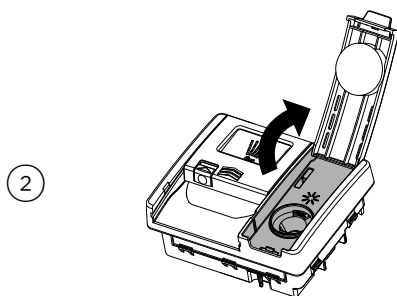

Lift the cover open and pour rinse aid into the opening.

Do not fill past the **MAX** line. Take care not to spill any onto the door or detergent bucket.

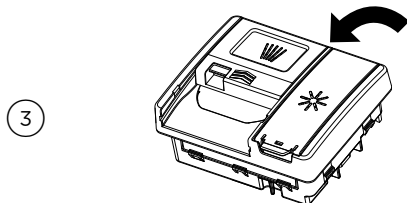

Close the cover, ensuring it clicks shut.

Any accidental spillages into the dishwasher or detergent bucket must be cleaned up immediately. Spilt rinse aid may result in excessive foaming. A service call relating to these errors will not be covered by warranty.



## RACKING FEATURES

### Cutlery basket

To reduce the risk of injury, load knives and sharp utensils with handles facing up. Mix spoons, knives and forks within each section to stop cutlery nesting together and to ensure the water circulates freely.

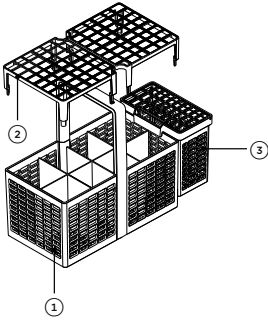

#### Features

- ① Cutlery basket
- ② Removable anti-nesting grid
- ③ Small items container

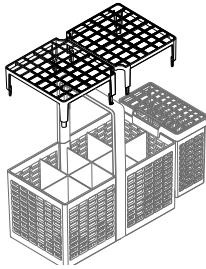

#### Removable anti-nesting grid

Use the grid to separate cutlery items and stop them from nesting together. The grid clips onto the top of the cutlery basket.

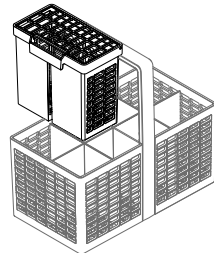

#### Small items container

Use the container to secure small, light weight items such as baby bottle teats.

The container can clip into or on the side of the cutlery basket, or can be placed elsewhere in the dishwasher.

If placed elsewhere in the dishwasher, ensure water from the spray arm can still reach items in the container. If laid flat, ensure the solid plastic side is facing up.

### Cutlery/Utensil tray

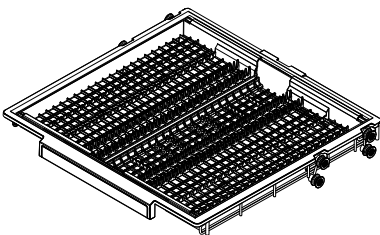

Use the tray to secure cutlery and utensils. Place cutlery into the notches to secure. Place larger utensils in the middle of the tray.

Slide side sections to the middle to create more space for items below.

## RACKING FEATURES

### Upper basket

Adjust the height of the upper basket to make space for taller items. You can adjust the height either while the basket is empty or loaded. If the basket is loaded we recommend raising or lowering one side at a time. Both sides of the basket must be adjusted to the same height.

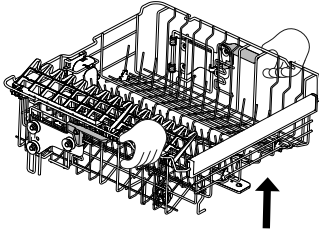

#### To raise

Pull the basket upwards until it clicks into place.

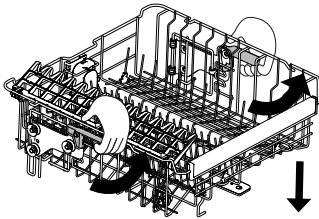

#### To lower

- ① Pull up the levers on each side to release.
- ② Lower to the desired position.
- ③ Release the levers to secure.

### Foldaway cup racks

Adjust the height to suit or fold out of the way to make space for other items. Use the notches to support wine glass stems.

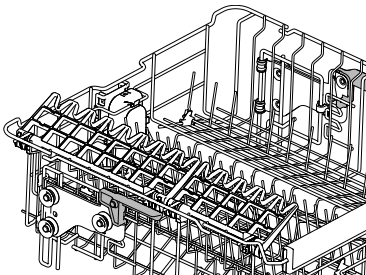

#### To adjust height

- ① Fold up to unlock.
- ② Adjust the height to suit by sliding up or down.
- ③ Fold back down to lock in position.

### Folding tine rack

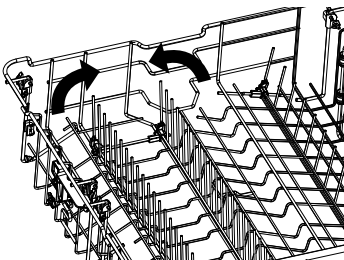

All tines can be folded down as needed to make space for other items.

## MAINTENANCE

Disconnect the dishwasher from the power supply and allow it to cool before undertaking any cleaning or maintenance.

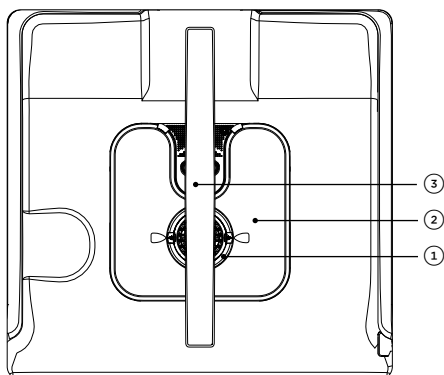

### Maintenance parts

- ① Filter
- ② Filter plate
- ③ Lower spray arm

Not shown: middle and upper spray arms.

### Cleaning surfaces

Wipe with a damp cloth and dry using a lint-free cloth. We do not recommend using the following cleaning aids as they may damage the surfaces:

- Plastic or stainless steel scouring pads
- Abrasive, solvent, household cleaners
- Acid or alkaline cleaners
- Hand washing liquids or soap
- Stainless steel cleaners or polishes
- Laundry detergents or disinfectants

### Cleaning the filter, spray arms and filter plate

We recommend that the drain filter and filter plate are removed and cleaned once a month or whenever there is evidence of food particles. The spray arms in normal use should require cleaning less frequently. Lower and middle spray arms can be shaken to remove any foreign material, cleaned in hot water, then rinsed in clean water.

The dishwasher must be used with the filter plate, drain filter and spray arms correctly in place. If using a dishwasher cleaner or descaler, refer to manufacturer instructions.

### Extended periods of disuse

If your dishwasher is not going to be used for some time we recommend turning off the power and water supply, leaving it clean and empty with the door ajar. When using your dishwasher for the first time after a long period away, we recommend pouring 3 cups of water into the dishwasher before use. This helps lubricate components that may have dried out during disuse.

## MAINTENANCE

### Removing and cleaning the filter

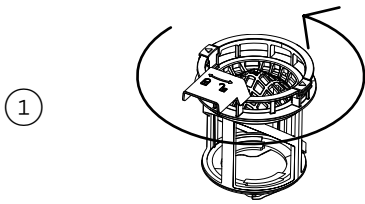

Twist the filter anti-clockwise to release.  
Lift to remove.

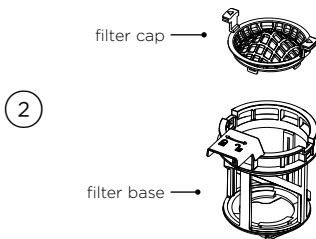

Separate the filter cap from the base by  
pressing the release buttons and lifting.

**Do not attempt to remove the filter by  
force as this may cause damage.**

Clean under hot water and rinse thoroughly.

### Replacing the filter

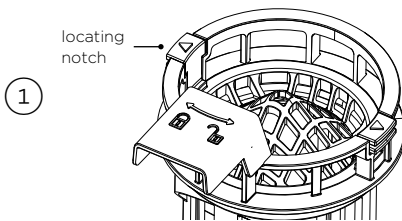

Align the filter cap with the notch on the  
filter base. Click together to secure.

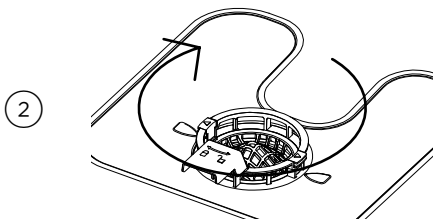

Place the drain filter back into the dishwasher  
base. Rotate clockwise to click into place.

## MAINTENANCE

### Removing and cleaning the filter plate

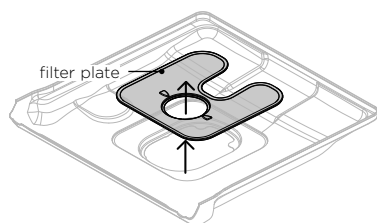

With the filter removed, carefully lift the filter plate up and out.

Clean under hot water and rinse thoroughly.

### Replacing the filter plate

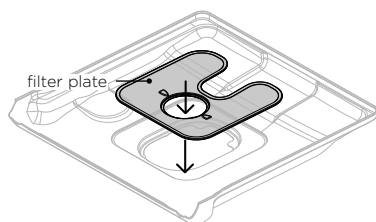

Slot the filter plate under the locating clips at the rear of the drain and push firmly back into place.

Ensure the filter plate is flush with the dishwasher base.

### Cleaning the upper spray arm

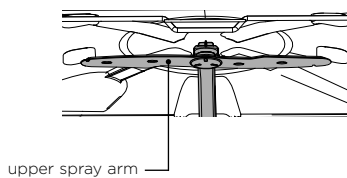

Do not remove the upper spray arm for cleaning.

Clean with a small, plastic-bristled brush.

If heavily soiled or blocked use a dishwasher cleaner/descaler. Follow the manufacturer's instructions.

### Cleaning the middle spray arm

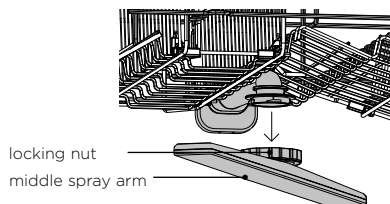

To remove the middle spray arm, turn the locking nut clockwise to release.

Rinse the spray arm thoroughly under running water, then refit.

## MAINTENANCE

### Cleaning the lower spray arm

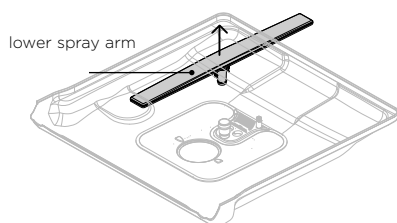

To remove the lower spray arm, lift it from the base of the dishwasher.

Rinse the spray arm thoroughly under running water, then refit.

Ensure the arm rotates freely when refitted.

### Winterizing (cold climates)

If the Dishwasher is installed in a cold climate where temperatures fall below freezing, we recommend winterizing.

1

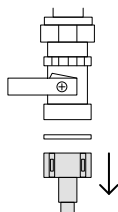

Turn off the water supply.

Disconnect the drain hoses from the sink drain pipe and the water inlet pipe from the water valve.

2

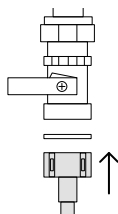

Drain the water from the hoses, inlet pipe and water valve, using a bucket or pan to collect the water.

Reconnect the water inlet pipe to the water valve and hoses to the sink drain pipe.

3

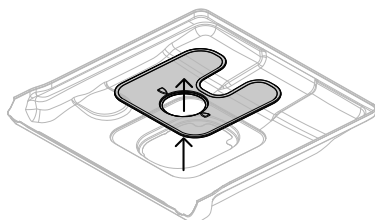

Remove the drain filter and the filter plate. Use a sponge to remove any remaining water from underneath before replacing.

## TROUBLESHOOTING

| PROBLEM   | POSSIBLE CAUSE  | WHAT TO DO   |
|---|---|--|
| <b>Dishwasher will not start</b>                            | No power.   | Ensure the dishwasher is plugged in and the power supply is turned on at the wall.   |
|   | The door is not properly closed.                              | Close the door.  |
|   | ▶II has not been pressed.                                     | Press ▶II.   |
|   | Water tap not turned on.                                      | Ensure water is connected and turned on.   |
|   | Blocked strainer in water inlet hose.                         | Check the strainer and clean if necessary - it is located where the water inlet hose screws into the tap.                                  |
| <b>Lower spray arm rotates with difficulty</b>              | Spray arm holes are blocked by small items or food particles. | Clean the spray arm. Refer to 'Maintenance' for instructions.  |
| <b>Cover of detergent dispenser cannot be closed</b>        | Detergent compartment has been overfilled.                    | Remove detergent until the cover can be closed.  |
|   | Detergent dispenser is clogged with remnants of detergent.    | Wipe dispenser out with a damp cloth. Dry the dispenser before adding detergent.   |
| <b>Remnants of detergent stuck inside dispenser</b>         | Compartment was damp when filled with detergent.              | Wipe dispenser out with a damp cloth. Dry the dispenser before adding detergent.   |
|   | Utensils are blocking the detergent dispenser from opening.   | Ensure there are no large utensils positioned in a way that will stop the dispenser cover from opening when the dishwasher door is closed. |
| <b>Water remains inside dishwasher after wash has ended</b> | Blocked drain connection.                                     | Check that drain connection is free from blockages.  |
|   | Drain hose is crimped, bent, or blocked.                      | Check the drain hose and straighten if needed.   |
|   | Pump is jammed.   | Clean the pump. See 'Fault codes' for instructions.  |
|   | Filter(s) blocked.  | Clean the filter(s). See 'Maintenance' for instructions.   |

## TROUBLESHOOTING

| PROBLEM  | POSSIBLE CAUSE   | WHAT TO DO  |
|--|--|---|
| <b>Foaming</b>                                       | Incorrect amount or type of detergent used.            | Refer to 'Detergent' or consult the detergent manufacturer's instructions.  |
|  | Too much egg in the wash load.                         | Increase the amount of detergent.   |
|  | Rinse aid dosage level too high.                       | Decrease the rinse aid dosage.  |
|  | Rinse aid spills not wiped up.                         | Ensure that all rinse aid spills are wiped up when they occur.  |
| <b>The dishwasher stops suddenly during the wash</b> | Power or water supply has been interrupted.            | Check the power and water supplies.   |
| <b>Knocking or rattling sound during wash</b>        | Spray arm knocking against dishes.                     | Pause the wash and rearrange dishes. Refer to 'Setting a wash' and 'Loading suggestions'.   |
|  | Dishes have been stacked incorrectly.                  |   |
| <b>Unclean dishes</b>                                | Unsuitable wash program for load selected.             | Select the appropriate wash program for the load. Refer to 'Wash programs'.   |
|  | Soils were too heavily baked on.                       | Dishes may need soaking.  |
|  | Spray arm(s) unable to rotate.                         | Ensure no items are obstructing the spray arm path.   |
|  | Basket/rack incorrectly loaded.                        | Refer to 'Loading suggestions'.   |
|  | Filter plate or filter incorrectly installed.          | Refer to 'Maintenance'.   |
|  | Detergent put in the wrong compartment.                | Refer to 'Wash programs' and 'Detergent'.   |
|  | Excessive food not removed from dishes before loading. | Scrape all food scraps off dishes before loading.   |
|  | Unsuitable detergent.                                  | Only use powdered or tablet detergent designed for domestic dishwashers.  |
|  | Not enough detergent.                                  | Refer to 'Detergent' for recommended quantities. You may need to adjust these to suit your particular load and the hardness of your water supply. |
|  | Spray arm holes are blocked.                           | Clean the spray arm(s). Refer to 'Maintenance' for instructions.  |
|  | The filters are blocked.                               | Clean the filters. Refer to 'Maintenance' for instructions.   |



## TROUBLESHOOTING

| <b>PROBLEM</b>   | <b>POSSIBLE CAUSE</b>   | <b>WHAT TO DO</b>   |
|--|---|---|
| <b>Plastic items are discoloured (e.g. stain left by tomato sauce)</b>   | Not enough detergent, not pre-rinsed.                                     | Pre-rinse plastic dishes before placing in the dishwasher and/or add more detergent.<br><br>Alternatively, using the Rinse program after adding dishes may minimise staining. |
| <b>Display flashing while Keylock is on</b>                              | This is normal. The display remains on although the buttons are disabled. | No action required.   |
| <b>White stains are left on dishes; glasses have a milky appearance</b>  | Not enough detergent.   | Refer to 'Detergent' for recommended quantities. You may need to adjust these to suit the hardness of your water supply.  |
|  | Rinse aid dosage too low.   | Increase rinse aid dosage.<br>Refer to 'Rinse aid'.   |
| <b>Dishes, cutlery have not dried</b>                                    | Rinse aid dosage too low.   | Increase rinse aid dosage.<br>Refer to 'Rinse aid'.   |
|  | Items removed too soon.   | After the end of the wash program, leave the door ajar and wait for several minutes to help drying.   |
|  | Rinse aid dispenser empty. (Rinse aid indicator is lit.)                  | Add rinse aid. Refer to 'Rinse aid'.  |
| <b>Glasses have dull appearance</b>                                      | Rinse aid dosage too low.   | Increase rinse aid dosage.<br>Refer to 'Rinse aid'.   |
| <b>Tea stains or traces of lipstick have not been completely removed</b> | Not enough detergent.   | See section 'Detergent' for recommended quantities. You may need to adjust these to suit your particular load.  |
|  | Wash temperature too low.   | Select a wash program for heavily soiled dishes. Refer to 'Wash programs' for information.  |
| <b>Traces of rust on cutlery</b>   | Cutlery is not sufficiently rustproof.                                    | Wash by hand.   |
| <b>Glasses clouded and discoloured; milky coating</b>                    | Hard water situation.   | Increase detergent quantities.  |
|  | Glasses are not dishwasher proof.   | Wash by hand.   |

## TROUBLESHOOTING

| <b>PROBLEM</b>                                 | <b>POSSIBLE CAUSE</b>                         | <b>WHAT TO DO</b>  |
|--|---|--|
| <b>Water marks left on glasses and cutlery</b> | Rinse aid level or dosage setting is too low. | Ensure there is rinse aid in dispenser. If necessary, increase the rinse aid setting or try using a wash program with a higher temperature. Refer to 'Rinse aid' for information.                                      |
| <b>Hard water</b>                              |   | Increase the rinse aid setting and the amount of detergent. Refer to 'Preferences' and 'Water hardness'.<br><br>If living in an area with very hard water, consult a plumber on installing a household water softener. |

## FAULT CODES

---

### How do I know if there is a fault?

Your dishwasher will beep continuously and a fault code will flash in the display. There are two types of fault codes - 'F' and 'A'.

### To fix a fault

First try to fix the issue and clear the code according to the steps in the following tables. If the problem persists:

- ① Note down the fault code.
- ② Contact Customer Care for support or to organize a visit by a service technician. Refer to the Service and Warranty booklet for contact details.

### 'F' fault codes

You may be able to clear the fault by resetting the dishwasher. Follow the steps below

- ③ Press and hold **CANCEL** to stop the beeping, then again to clear the fault code.
- ④ Wait a few seconds, then press ► to turn the dishwasher back on.

If the fault code has disappeared, the fault has been reset and you can continue to use your dishwasher.

## FAULT CODES

### 'A' fault codes

Follow the steps below to try and fix the issue.

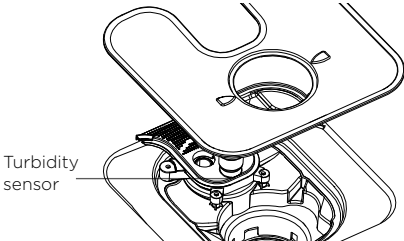
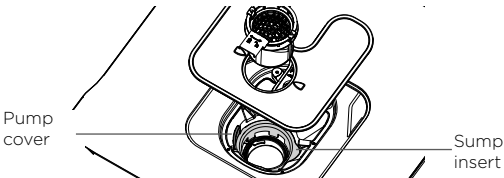
| PROBLEM                   | POSSIBLE CAUSE   | WHAT TO DO   |
|---------------------------|--|--|
| <b>A20</b><br>Drain fault | Drain hose is crimped or bent.   | Check the drain hose and straighten if needed.   |
|                           | Blocked drain connection.  | Check that drain connection is free from blockages.  |
|                           | The waste water is not draining out.   | Ensure that the drain hose is connected in accordance with the installation instructions.  |
|                           | The turbidity sensor is dirty and requires cleaning.                                   | Gently clean the turbidity sensor with a soft brush (ie toothbrush) to remove any buildup.   |
|                           |       |  |
|                           | Drain pump is blocked.   | Remove the drain filter and clear any water from the drain. Remove the sump insert and pump cover. Remove any remnants of food or blockages from the pump. Take care in case sharp objects or fragments of glass are blocking it, as these may cause injury. |
|                           |     |  |
| <b>A10</b><br>No water    | Water tap not turned on.   | Ensure the water is connected and turned on. Touch ► to restart the dishwasher.  |
|                           | Insufficient water supply pressure.  | Check household water pressure.  |
|                           | Water inlet hose is crimped or bent, so no or not enough water gets to the dishwasher. | Check the water inlet hose and straighten if needed. Touch ► to restart the dishwasher.  |
|                           | Drain hose is not connected correctly.   | Ensure that the drain hose is connected in accordance with the installation instructions.  |

## MANUFACTURER'S WARRANTY AND SERVICE GUIDE

---



### **To access your Warranty and Service Guide**

Scan the QR code with your smartphone to access your warranty and book a service, or view online at:

#### **New Zealand**

<https://www.fisherpaykel.com/nz/help-and-support/warranty-information>

#### **Australia**

<https://www.fisherpaykel.com/au/help-and-support/warranty-information>

#### **Singapore**

<https://www.fisherpaykel.com/sg/help-and-support/warranty-information>

This product has been designed for use in a domestic (residential) environment. This product is not designed for any commercial use. Any commercial use by the customer will affect this product's Manufacturer's Warranty.

For spare parts, please contact Fisher & Paykel Customer Care. Spare parts are available for all Fisher & Paykel products for a minimum period of 10 years from the date of manufacture.

## CUSTOMER CARE

---

### **Before you call for service or assistance**

Check the things you can do yourself. Refer to your User guide and check:

- ① Your product is correctly installed.
- ② You are familiar with its normal operation.
- ③ You have read the 'Fault codes' and 'Troubleshooting' sections.

If after checking these points you still need assistance or parts, please refer to your nearest Fisher & Paykel trained and supported service technician, Customer Care, or contact us through our website [fisherpaykel.com](http://fisherpaykel.com).

### **In NZ if you need assistance**

Call the Fisher & Paykel Customer Care Centre and talk to one of our Customer Care Consultants.

**Phone:** 0800 372 273

**Website:** [fisherpaykel.com](http://fisherpaykel.com)

**Email:** [customer.care@fp.co.nz](mailto:customer.care@fp.co.nz)

**Postal address:**

Fisher & Paykel Appliances New Zealand,  
PO BOX 58546, Botany, Auckland  
New Zealand

### **In Australia if you need assistance**

Call the Fisher & Paykel Customer Care Centre and talk to one of our Customer Care Consultants.

**Phone:** 1300 650 590

**Website:** [fisherpaykel.com](http://fisherpaykel.com)

**Email:** [customer.care@fp.com.au](mailto:customer.care@fp.com.au)

**Postal address:**

Fisher & Paykel Appliances Australia  
Level 1, 1 Eden Park Drive  
Macquarie Park, NSW2113  
Australia

### **In Singapore if you need assistance**

Call the Fisher & Paykel Customer Care Centre and talk to one of our Customer Care Consultants.

**Phone:** +65 6741 0777

**Website:** [fisherpaykel.com](http://fisherpaykel.com)

**Email:** [sg.customercare@fisherpaykel.com](mailto:sg.customercare@fisherpaykel.com)

**Postal address:**

Fisher & Paykel Appliances  
51 Kampong Bugis  
#01-05 Kallang Riverside Condominium  
Singapore 338986

## CUSTOMER CARE

---

### If you need service

Fisher & Paykel has a network of Fisher & Paykel trained and supported service technicians that can carry out any service necessary on your appliance. Our Customer Care Centre can recommend a Fisher & Paykel trained and supported service technician in your area. Or you can book one online at [fisherpaykel.com/uk/help-and-support](http://fisherpaykel.com/uk/help-and-support), [fisherpaykel.com/ie/help-and-support](http://fisherpaykel.com/ie/help-and-support), [fisherpaykel.com/eu/help-and-support](http://fisherpaykel.com/eu/help-and-support) or [fisherpaykel.com/sg/help-and-support](http://fisherpaykel.com/sg/help-and-support)

If you call, write or contact us via our website please provide: your name and address, model number, serial number, date of purchase and a complete description of the problem. This information is needed in order to better respond to your request for assistance.

### Complete and keep for safe reference:

Model \_\_\_\_\_

Serial No. \_\_\_\_\_

Purchase Date \_\_\_\_\_

Purchaser \_\_\_\_\_

Dealer \_\_\_\_\_

Suburb \_\_\_\_\_

Town \_\_\_\_\_

Country \_\_\_\_\_

## **FISHERPAYKEL.COM**

© Fisher & Paykel Appliances 2024. All rights reserved.

The models shown in this guide may not be available in all markets  
and are subject to change at any time.

The product specifications in this guide apply to the specific products and  
models described at the date of issue. Under our policy of continuous product  
improvement, these specifications may change at any time.

For current details about model and specification availability in your country,  
please go to our website or contact your local Fisher & Paykel dealer.

**431199C 12.24**