

FISHER & PAYKEL

STEAM OVEN

PROFESSIONAL

OS76NPX1 models

USER GUIDE

NZ AU

CONTENTS

| | |
|----------------------|----|
| Safety and warnings | 5 |
| Before you begin | 9 |
| Control panel | 10 |
| Accessories | 11 |
| First use | 12 |
| Using the oven light | 16 |
| Using the timer | 17 |
| Automatic cooking | 18 |
| Cooking guide | 20 |
| Steam cooking | 21 |
| Using the food probe | 24 |
| Recipes | 28 |
| Event logs | 32 |
| Care and cleaning | 33 |
| Troubleshooting | 36 |

Registration

To register your product visit our website: fisherpaykel.com/register

SAFETY AND WARNINGS

Operation

Your oven has been carefully designed to operate safely during normal cooking procedures. Keep the following safety instructions in mind when you are using it:

⚠ WARNING!



Electrical Shock Hazard

Failure to follow this advice may result in electrical shock or death.

- Before carrying out any work on the electrical section of the appliance, it must be disconnected from the mains electricity supply.
- Connection to a good ground wiring system is absolutely essential and mandatory.
- Alterations to the domestic wiring system must only be made by a qualified electrician.
- Turn the oven off at the wall before replacing the oven lamp.

⚠ WARNING!



Fire Hazard

Failure to follow this advice may result in overheating, burning, and injury.

- Do not place aluminium foil, dishes, trays, water or ice on the oven floor during cooking, as doing so will irreversibly damage the enamel; lining the oven with aluminium foil may even cause fire.
- Do not use adapters, reducers, or branching devices to connect this appliance to the mains power supply.
- Never use your appliance for warming or heating the room. Persons could be burned or injured or a fire could start.
- Storage in or on appliance: flammable materials should not be stored in an oven or near its surface.

⚠ WARNING!



Cut Hazard

Failure to use caution could result in injury.

- Take care - some edges are sharp.

⚠ WARNING!



Hot Surface Hazard

Failure to follow this advice could result in burns and scalds.

- To avoid burns and scalds, keep children away from this appliance.
- Surfaces of the appliance may become hot enough to cause burns. Examples include the oven vent, the surface near the oven vent, and the oven door.
- Do not touch heating elements or interior surfaces of the oven. Heating elements may be hot, even when they are dark in colour.
- Use protection when handling hot surfaces, such as oven shelves or dishes, or when using steam functions.
- Be careful when opening the oven door as hot air and steam can be emitted, especially when using steam functions. Allow hot air and steam to dissipate before removing or replacing food.
- During and after use, do not touch or let clothing or other flammable materials contact heating elements or interior surfaces of the oven until they have had sufficient time to cool.

SAFETY AND WARNINGS

READ AND SAVE THIS GUIDE

WARNING!

To reduce the risk of fire, electrical shock, injury to persons or damage when using the oven, follow the important safety instructions listed below. Read all the instructions before using the oven. Use the oven only for its intended purpose as described in these instructions.

Installation

- Ensure your appliance is properly installed and earthed by a qualified technician.
- Ensure this oven is connected to a circuit which incorporates an isolating switch providing full disconnection from the power supply.
- Do not install or operate the appliance if it is damaged or not working properly. If you receive a damaged product, contact your dealer or installer immediately.

Servicing

- Do not repair or replace any part of the appliance unless specifically recommended in the user guide. All other servicing should be undertaken by a Fisher & Paykel trained and supported service technician or qualified person.

Fire Hazard

- Do not use water on grease fires. Smother the fire or flame or use a dry chemical or foam type extinguisher.
- Use only dry oven mitts or potholders. Moist or damp potholders on hot surfaces could result in burns from steam. Do not let potholders touch hot areas or heating elements. Do not use a towel or a bulky cloth for a potholder. It could catch fire.
- Do not heat unopened food containers. They can build up pressure that may cause the container to burst and result in injury.

Food Safety

- Leave food in the oven for as short a time as possible before and after cooking. This is to avoid contamination by organisms which may cause food poisoning. Take particular care during warm weather.

General Use

- This product has been designed for use in a domestic (residential) environment. This product is not designed for any commercial use. Any commercial use by the customer will affect this product's manufacturer's warranty.
- Household appliances are not intended to be played with by children.
- Children should not be left alone or unattended in the area where the appliance is in use. They should never be allowed to sit or stand on any part of the appliance.
- Children of less than 8 years old must be kept away from the appliance unless continuously supervised.
- Cleaning and user maintenance shall not be carried out by children without supervision.
- Do not store things children might want above the oven. Children could be burned or injured while climbing on the oven to retrieve items.
- Do not place heavy objects on the oven door.
- Always keep oven vents unobstructed. Do not wear loose fitting or hanging garments when using the appliance. They could ignite or melt if they touch an element or hot surface and you could be burned.

SAFETY AND WARNINGS

- Do not change or modify the wireless communication device in any way. Changes or modifications not expressly approved by Fisher & Paykel could void the user's authority to operate the equipment.
- Caution: Hot air can blow from the vent at the top of the oven as part of the oven's cooling system.
- Always position shelves in the desired location while the oven is cool (before preheating). If a shelf must be removed while the oven is hot, do not let the oven mitts or potholder contact hot heating elements in the oven or the base of the oven.
- Use only bakeware approved for oven. Follow the bakeware manufacturer's guidance.
- Always place oven racks in desired location while oven is cool. If rack must be moved while oven is hot, do not let potholder contact hot heating element.
- Do not touch heating elements or interior surfaces of your oven. Heating elements and interior surfaces may be hot even though they are dark in color and could cause burns. The oven door, vent openings and surfaces near these openings may also become hot.
- This appliance is configurable to allow remote operation at any time. Do not store flammable materials or temperature sensitive items inside, on top or near the appliance.
- Neither the food probe or aluminium foil must come in contact with the oven elements.
- Only use the temperature probe recommended for this oven.
- The appliance must not be installed behind a decorative door in order to avoid overheating.
- **WARNING:** Accessible parts may become hot during use. Young children should be kept away.

Cleaning

- Do not clean the oven seal or use any oven-cleaning products on it. It is essential for a good seal, which ensures that the oven operates efficiently. Care should be taken not to rub, damage, move or remove the oven seal.
- Do not use oven cleaners, harsh/abrasive cleaning agents, waxes, or polishes. No commercial oven cleaner, oven liner, or protective coating of any kind should be used in or around any part of the oven.
- Do not use harsh/abrasive cleaners, scourers or sharp metal scrapers to clean the oven door glass since they scratch the surface, which may result in the glass shattering.
- Clean only the parts listed in this manual.
- Do not use a steam cleaner to clean any part of the oven.
- The door gasket is essential for a good seal. Care should be taken not to rub, damage or move the gasket.

BEFORE YOU BEGIN

- Make sure the installer has completed the 'Final checklist' in the Installation Guide.
- Read this guide, taking special note of the 'Safety and warnings' section.
- Remove all internal and external packaging and dispose of it responsibly. Recycle items that you can.
- The oven should be thoroughly cleaned with soap and water and carefully rinsed.
- It is important that you condition the oven before using it for cooking and baking. Conditioning will burn off any manufacturing residue and ensure you get the best results from the start. There will be a distinctive smell and a small amount of smoke during conditioning. This is normal, but make sure the kitchen is well ventilated.
- Heat the oven for 30 minutes at the maximum temperature. Use the **Fan Heat** function without accessories in the oven.
- Before using the accessories for the first time, clean them carefully with hot water, dishwashing liquid and a soft cloth.

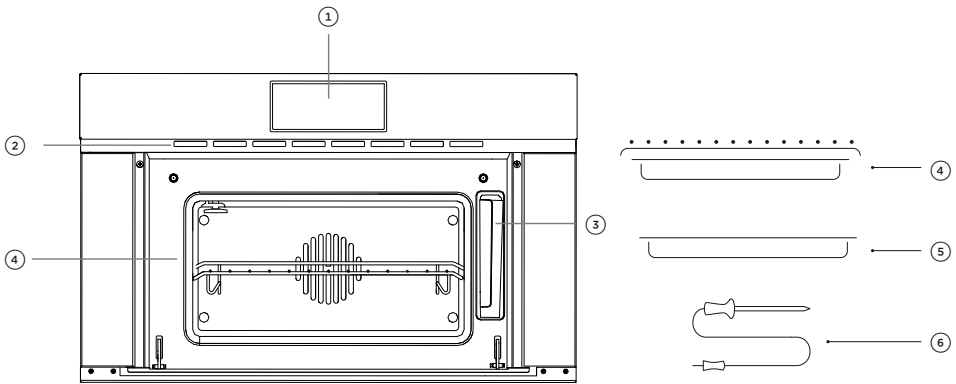

Oven features and accessories

- | | |
|-----------------------------|----------------------------|
| ① Control panel | ⑤ Perforated tray with lid |
| ② Oven vent louvres | ⑥ Food probe |
| ③ Water tank | |
| ④ Wire shelf and baking pan | |

Not illustrated: oven door, handle, oven light and oven seal

CONTROL PANEL



Control panel features

- ① Display
- ② Keypad
- ③ Cancel
- ④ Navigation arrow
- ⑤ Power
- ⑥ Confirm
- ⑦ Timer/Automatic cooking
- ⑧ Cavity light

Using the touch controls

Your oven is operated using a touch keypad and display. To use the keypad to navigate between functions and settings, use the ball of your finger, not its tip. The controls respond to touch, so pressure is not needed.

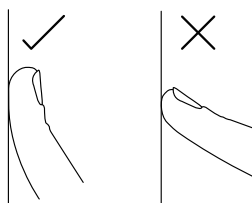

ACCESSORIES

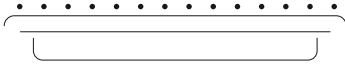

Wire shelf and baking pan

To remove, pull towards you and then lift.

To insert, slide the shelf at a 45° angle until it locks. Then lower and push the shelf all the way to the end of the broil track.

The baking pan can be positioned below the wire to use as a drip tray.

To remove the shelf when the baking pan is fitted, lift it slightly and slide it towards you.



Perforated tray with lid

Use for steam cooking.

Place the tray in its support and position it on the wire shelf.

We recommend using it in combination with the baking pan to catch any drips during cooking.

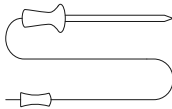

Food probe

Use the food probe to accurately judge when food is perfectly cooked.

See 'Using the food probe' for full instructions on how to use.

FIRST USE

When using your oven for the first time, you will be prompted to:

- set the clock format (12 hours or 24 hours)
- set the time
- set the date
- select the language of the display
- select units for temperature and weight

These settings can be modified at any time in the settings menu.

①

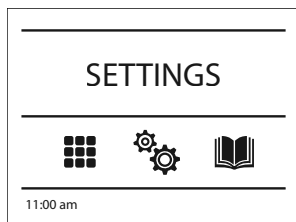

Locate the **SETTINGS** menu using the arrow keys. Press ✓ to confirm.

②

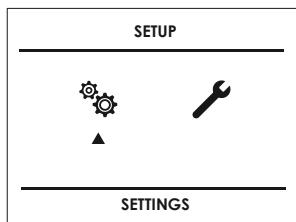

Press ✓ to enter the sub-menu.

③

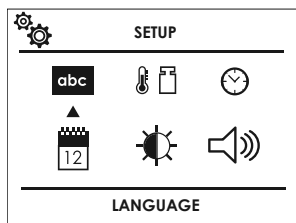

Select the setting you want to change, adjust as needed then press ✓ to confirm.

FIRST USE

Conditioning the oven

It is important that you condition the oven before using it for cooking. Conditioning will burn off any manufacturing residue and ensure you get the best results from the start. Ensure the kitchen is well ventilated before beginning.

1

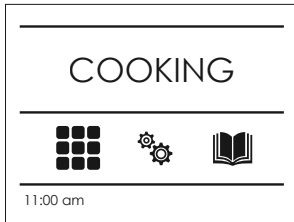

Enter the **COOKING** menu by locating  and pressing ✓ to select.

2

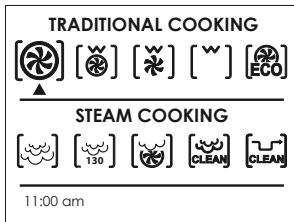

Press ✓ to select **FAN HEAT**.

3

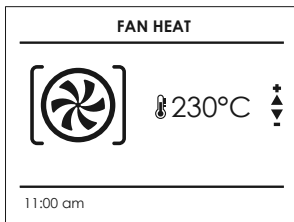

Set the temperature to 230°C for 30 minutes.

After conditioning

There will be a distinctive smell and a small amount of smoke during the conditioning process as manufacturing residue is burnt off. This is normal. Once cooled, wipe out the oven with a damp cloth and mild detergent, and dry thoroughly.

Selecting and using a function

1

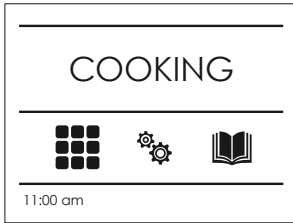

Enter the function menu by locating  and pressing ✓ to select.

2

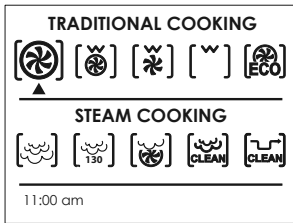

Select the appropriate cooking mode by pressing ◀ ▶ and ▲ ▼ confirm by pressing ✓.

3

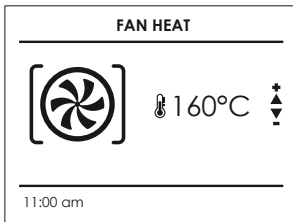

Use the ▲ ▼ to adjust the temperature before pressing ✓ to begin cooking.

If no temperature is selected after 10 seconds, the default temperature will be used.

To pause cooking, press ✓ at any point. Press ✓ to resume.

4

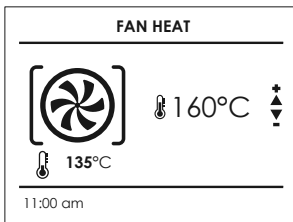

When preheating, the current temperature will be shown in the display alongside the preheat icon. When the set temperature is reached a tone will sound and the temperature value disappears from the display.

FIRST USE

Editing or cancelling cooking

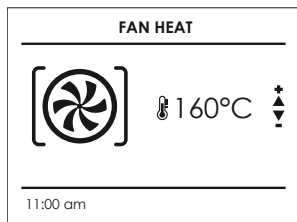

Changing the temperature

Press ▲ ▼ to adjust the temperature then press ✓ to confirm.



Changing the function

Press ✓ to pause, then ✕ to return to the function menu. Use ◀ ▶ to navigate to a new function and press ✓ to confirm.

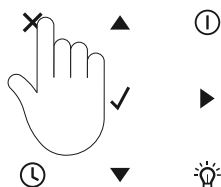

Cancelling cooking

To cancel cooking, press ✓ to pause, then ✕ to exit at any time.

USING THE OVEN LIGHT

The oven lights will turn on automatically when the door is opened or a cooking mode has started. During cooking, the lights will automatically dim after 3 minutes.

Turning the oven light ON or OFF

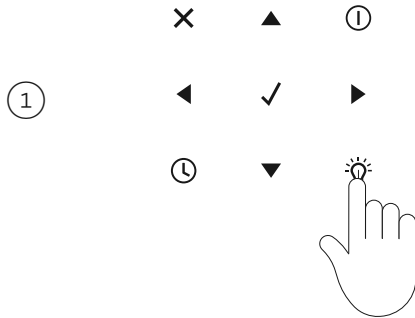

Press  at any time, or open the door.

USING THE TIMER

The timer does not turn the appliance on or off. If you want to turn the oven off automatically, refer to the 'Automatic cooking' section.

The timer can be set for up to 12 hours and 59 minutes and is shown in the status bar as HR:MIN, before switching to MIN:SEC for the last minute.

When the time is complete, 00:00 will show in the status bar and a tone will sound.

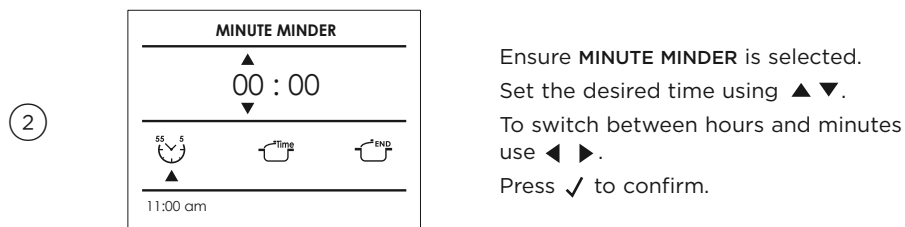

Editing or cancelling the timer

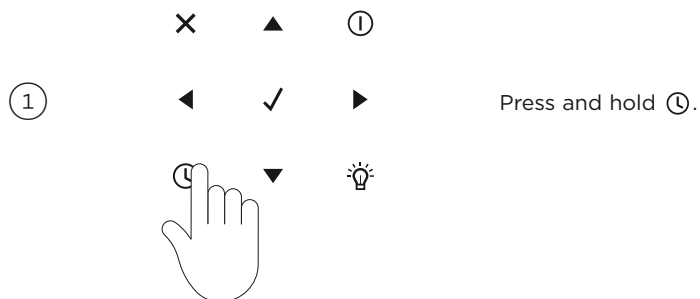



AUTOMATIC COOKING

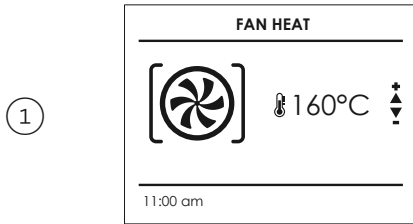

To use automatic cooking modes ensure the clock is displaying the correct time. Refer to 'First use' for setting the time. Use the automatic cooking function to set the oven to turn off after a set length of time.

Setting automatic cooking



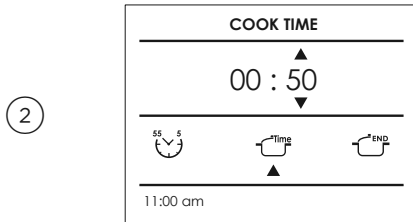



Select the cooking mode and temperature you wish to use and press , then select  by pressing .

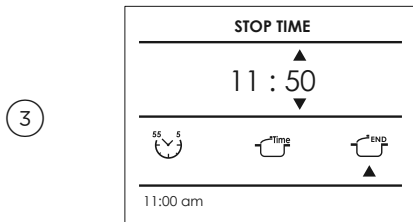

Set the desired cook time by using  . Press .

The maximum cooking time is 12 hours.



Select  and set the desired stop time by using  . Press .

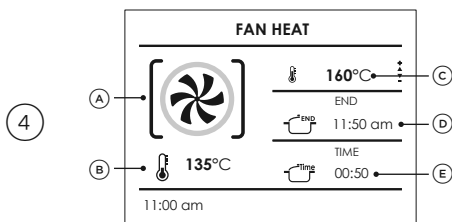

During cooking, the following will be displayed:

- (A) function
- (B) current temperature
- (C) target temperature
- (D) end time
- (E) time elapsed

When the end time is reached



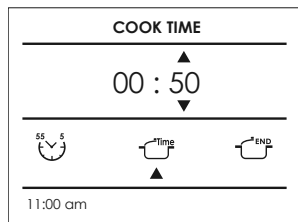

The oven will automatically turn off and a tone will sound.

AUTOMATIC COOKING

Editing or cancelling automatic cooking





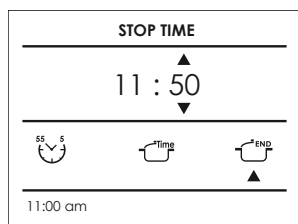

Changing the cook time

Press  and change the desired cook time using  . Press  to confirm.











Changing the end time



Press , then select  and change the desired cook time using  . Press  to confirm.

COOKING GUIDE

All oven functions default to the recommended temperature, these can be altered at any time.

| CONVECTION FUNCTIONS | DEFAULT TEMPERATURE | TEMPERATURE RANGE |
|----------------------------------------------------------------------------------------------------------|---------------------|-------------------|
| | °C | °C |
|  FAN HEAT | 165 | 50-230 |
|  FAN HEAT + GRILL | 210 | 50-230 |
|  TURBO GRILL + BASE HEAT | 165 | 50-230 |
|  ECO GRILL | 230 | 50-230 |
|  ECO BAKING | 165 | 50-230 |

| STEAM FUNCTIONS | DEFAULT TEMPERATURE | TEMPERATURE RANGE |
|---------------------------------------------------------------------------------------------------|---------------------|-------------------|
| | °C | °C |
|  STEAM 100 | 100 | 40-100 |
|  STEAM 130 | 130 | 70-130 |
|  STEAM + FAN HEAT | 165 | 50-230 |

| CLEAN FUNCTIONS | DEFAULT TEMPERATURE | TEMPERATURE RANGE |
|--------------------------------------------------------------------------------------------------------|---------------------|-------------------|
| | °C | °C |
|  CLEAN STEAM OVEN | 100 | - |
|  CLEAN STEAM CIRCUIT | - | - |

STEAM COOKING

Steam cooking has numerous benefits which include retaining the nutritional value of food, along with retaining taste, structure, color and natural juices.

To ensure best results when using the steam function:

- Start cooking food from a cold oven. Avoid using the steam cooking function directly after using the convection oven, as this will reduce the benefits of steam cooking.
- Use the perforated stainless steel tray together with the baking pan. This allows food to be fully cooked while collecting juice from the food in the tray.
- Use oven safe dishes and trays when using the steam functions. Remove any lids and ensure food is positioned above the grill.
- After cooking, the support of the perforated tray can be used to keep the hot tray off of the counter while you remove the food you just cooked.

Steam functions

Steam 100

This function allows you to cook on three different rack levels at the same time. We recommend placing meat on the upper and middle racks and vegetables on the middle and lower racks.

Steam 130

This mode allows you to modify the temperature while steam cooking.

This type of function is particularly suitable for heating pre-cooked food and for preparing ready, semi-ready meals and frozen foods from 72°C to 130°C.

Steam & Fan Heat

After starting the oven, food is initially steamed. Depending on the size and amount of food being cooked, the oven will automatically move into a convection cooking phase.

This function is particularly suited to cooking large meat and seafood dishes as well as baking bread and pastries. The recommended cooking temperature for baking bread and pastries using this function is from 180°C to 210°C.

If you're using this function to cook consecutive dishes, ensure the oven has cooled before starting to cook the next dish.

STEAM COOKING

Filling the water container

Before using any steam functions, the water container must be filled.

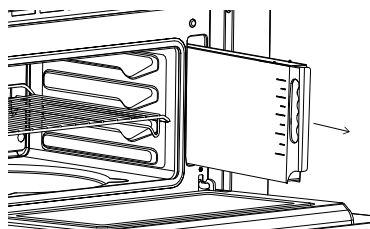

Open the oven door and remove the water tank. Fill with fresh, cold water to the **MAX** line then replace.

CHECK WATER CONTAINER may appear on the display during cooking. Open the door and refill the water tank, taking care to avoid hot steam that will be released.

When the door is closed, the oven will go into **PAUSE** mode. Press **✓** to continue cooking.

To start steam cooking

①

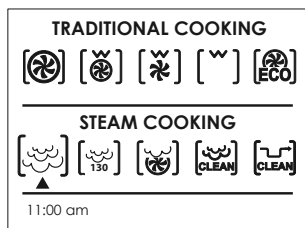

Select the required steam function from the available options by pressing **◀ ▶**. Press **✓** to confirm.

The steam function will not start until the door is closed.

To pause steam cooking

②

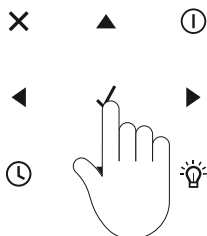

Press **✓** at any time to pause cooking.

Press **✓** again to restart.

Once steam cooking is complete, a circuit discharge prompt will appear on the display. See 'Care and cleaning' for details.

STEAM COOKING

Steam assist function

This particular function can only be used with convection oven functions. By adding steam to the oven cavity it will ensure that food remains tender and does not dry out. This function is ideal for cooking roasts, seafood or large meat dishes.





Once the oven has been turned on, the steam assist function will only become available once the internal oven temperature has exceeded 100°C.

At this stage  will appear on the display.

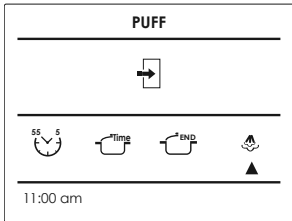
This function is not enabled during steam cooking.

To use steam assist



To inject steam inside the cavity, press  then select  using   and confirm your selection by pressing .

The steam assist function will continue for five minutes, and will then return to the previously set cooking function.

USING THE FOOD PROBE

Setting the temperature for food probe

Use your food probe to accurately judge when meat and other food is perfectly cooked. The meat probe will gauge the core temperature of the food and will stop cooking when the selected temperature has been reached.

| FOOD | MINIMUM INTERNAL TEMPERATURE |
|---------------------------------------------|------------------------------|
| | °C |
| MINCE | |
| Hamburger | 74 |
| Beef, veal, lamb, pork | 74 |
| Chicken, turkey | 74 |
| BEEF, VEAL, LAMB (Roasts and steaks) | |
| Rare | 51 |
| Medium-rare | 57 |
| Medium | 63 |
| Well done | 71 |
| PORK (Chops, roasts, ribs) | |
| Medium | 71 |
| Well done | 77 |
| FRESH SAUSAGES | 74 |
| POULTRY | |
| Whole chicken or chicken pieces | 77 |
| Duck | 77 |
| Turkey breast | 77 |

USING THE FOOD PROBE

Tips for using the food probe

- To avoid burns, use a kitchen glove to fit and remove the probe when the oven is hot.
- Always remove the probe using the grip. Removing it by pulling the cable may cause damage.
- The probe is not enabled for all functions, for example the probe cannot be used when using the recipe function. If the probe is fitted during a function it is not enabled for, a removal message will appear on the display.
- If the probe is accidentally removed during cooking, a warning message will appear on the display.
- The temperature of the probe can be set between 40°C and 100°C. The oven will save the last temperature set by the user.
- The internal temperature of meat will continue to rise by a few degrees after you have removed it from the oven, so allow for this in your calculations. After cooking, cover and let the meat rest for 15 to 20 minutes.
- When cooking meat, insert the probe horizontally into the centre of the thickest part. The thicker the meat, the longer it will take to cook, so it is important that the probe is measuring the temperature of the meat at its thickest point. Make sure the probe does not touch bone, fat or gristle, as these will heat up more quickly than the lean meat.

Internal temperatures and food safety

- Ensure meat is fully defrosted before cooking.
- Rest meat after cooking to allow the internal temperature to continue to rise.
- For food safety, high risk foods such as fish should reach a minimum internal temperature of 63°C and poultry and minced meat should reach 75°C.

Before turning on the oven

The probe socket is located in the upper left corner of the oven cavity, protected by a metal cover.

Remove the cover and store in a safe place while cooking. This will need to be reinserted for other cooking functions.

Connecting the food probe

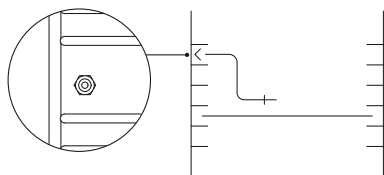

Plug the probe into the socket inside the oven. The probe should click into place.

The meat probe icon will appear on the display .

The probe will not work if it is connected when the oven is already turned on.

USING THE FOOD PROBE

Setting the food probe

1

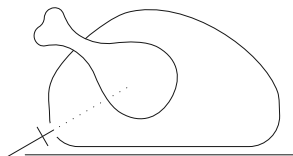

Insert the tip of the probe into the center of the thickest part of the fully defrosted meat.

2

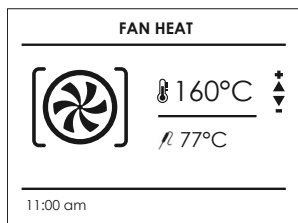

Select the cooking mode and then press ▲▼ to set the oven temperature and press ✓ to confirm.

3

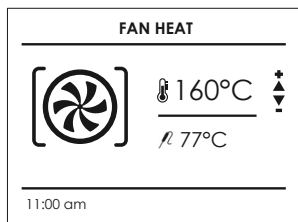

Set the required probe temperature by pressing ▲▼ and confirm your selection by pressing ✓.

4

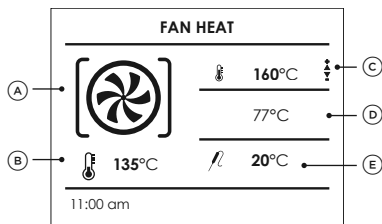

During cooking, the following will be displayed:

- (A) cooking mode
- (B) actual temperature
- (C) set temperature
- (D) Set probe temperature
- (E) current probe temp

When the end time is reached

The oven will automatically turn off and a tone will sound.

USING THE FOOD PROBE

To change the probe temperature

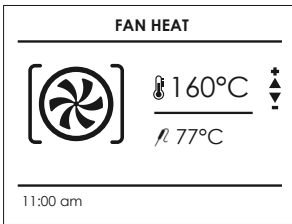







Select **✓** and then press **✕**.
Change the temperature by pressing **▲▼**
and confirm your selection by pressing **✓**.

After cooking has started, the oven temperature can be changed at any time by pressing **▲▼**.

RECIPES

The **RECIPE** function on your oven enables you to cook without having to set the oven manually every time. By selecting a recipe, the cooking mode, temperature and time are automatically set according to the recipe selected from the menu.

| RECIPE LIST | FOOD | FOOD CONDITION | RECIPES LIST | INFORMATION DISPLAYED |
|--------------------|-------------------------------------------------------------------------------------|----------------|----------------------|---------------------------------|
| PRESET or PERSONAL |  | FRESH | BREAD PIZZA FIRST | |
| | | FROZEN | | |
| |  | WHOLE | MEAT | TYPE OF ACCESSORY |
| | | IN PIECES | | |
| |  | WHOLE | POULTRY | LEVEL POSITION |
| | | IN PIECES | | FOOD WEIGHT |
| |  | WHOLE | FISH | COOKING TIME |
| | | IN PIECES | | |
| |  | | VEGETABLES | |
| | | | | PREHEAT REQUIRED (YES/NO) |
| |  | | PIES | |
| | | | | |

RECIPES



The recipe function has been designed to help achieve optimal oven conditions for cooking a particular food type. When in use, the function, temperature and time are set automatically and any additional details are displayed on screen.

Recipes can be added to a personal recipe list for quick access, refer to 'Saving a recipe' for details.

Using recipes



1



Press  then press .





2

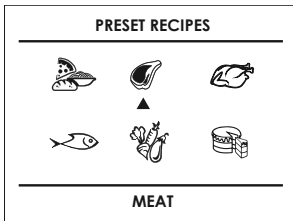

Press   to choose from **PRESET** or **PERSONAL**. Press  to confirm.

3



Select the desired food type by pressing   and  . Press  to confirm.

RECIPES

4

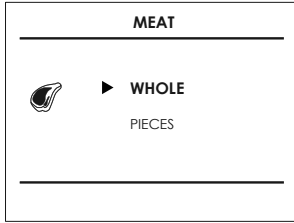

Press ▲ ▼ to refine food selection.
Press ✓ to confirm.

5

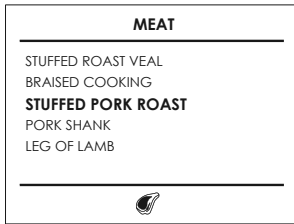

Select a recipe by pressing ▲ ▼.
Press ✓ to confirm.

6

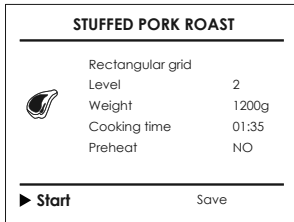

Press ✓ to start cooking.

7

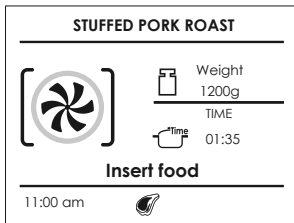

Follow the onscreen guidance.

When recipe is complete

The oven will automatically turn off and a tone will sound.

Saving a recipe

Commonly used recipes can be adjusted and saved for quick access. These can be found under **PERSONAL** recipes.

1

| STUFFED PORK ROAST | |
|-------------------------------------------------------------------------------------------------|--------------|
| Rectangular grid | |
| Level | 2 |
|  Weight | 1200g |
| Cooking time | 01:35 |
| Preheat | NO |
| <hr/> | |
| Start | Save |

Use ▲ to navigate to weight or cook time.
Press ✓ to confirm.

2

| MEAT | |
|-----------------------------------------------------------------------------------|--|
| Weight | |
| 1500g | |
| <hr/> | |
|  | |

Set the desired weight and cook time
before pressing ✓ to confirm.

3

| STUFFED PORK ROAST | |
|------------------------------------------------------------------------------------------|--------|
| Rectangular grid | |
| Level | 2 |
|  Weight | 1500g |
| Cooking time | 01:35 |
| Preheat | NO |
| <hr/> | |
| Start | ► Save |

Use ▲ to navigate to **SAVE**.
Press ✓ to confirm.

Removing a personalized recipe

1

| STUFFED PORK ROAST | |
|--------------------------------------|-------|
| Do you want to remove recipe? | |
| NO | ► YES |
| <hr/> | |

Select the recipe you want to remove
and press ◀. Press ▶ to select **YES**
and ✓ to confirm.

EVENT LOGS

The system menu allows access to event logs. This section displays any recorded errors, faults and all voltage information. These codes can be communicated to Customer Care in the event of a product fault.

①

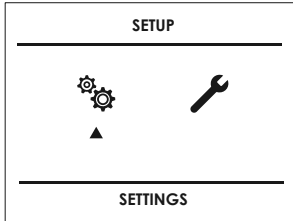

Select  and press  to confirm.

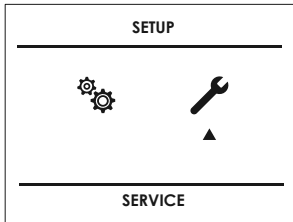

②

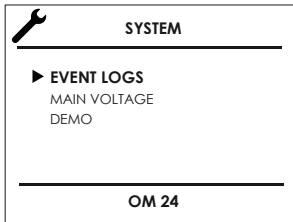

Select  and press  to confirm.

③



Press   choose from the available options.
Press  to confirm.

CARE AND CLEANING

Oven clean

This function performs a cleaning cycle by injecting steam into the cavity for 15 minutes. At the end of the cycle, any crusting that may have formed due to high-temperature cooking inside the oven cavity, will be softened and become much easier to remove.

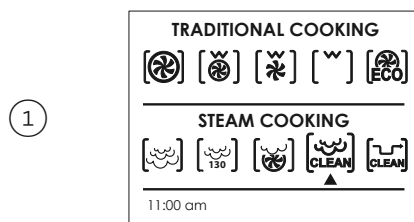

Fill the water tank.

Press . Press ◀ ▶ to select and confirm your selection by pressing .

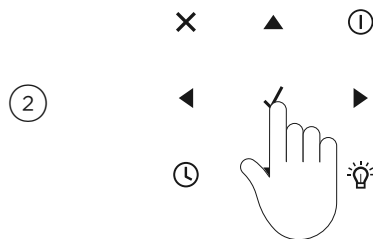

To cancel this function press to pause and then press .

Circuit clean

This function performs a cleaning cycle of the circuit, to keep it clean and operating efficiently.

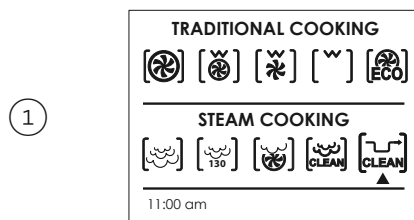

Press . Press ◀ ▶ to select and confirm your selection by pressing .

CARE AND CLEANING

Circuit discharge

At the end of any steam function, when the oven is turned off. The following message will appear on the display: **NEED TO DISCHARGE/OPEN THE DOOR.**

Carefully open the door as hot steam will be released. A message will appear on the display to remove the container and empty the water to the level indicated. When the water has been emptied, re-insert the container and press ✓.

At the end of this function, the message **DISCHARGE ENDED REMOVE AND EMPTY THE TANK** will appear on the display, confirming that the discharge was successful.

If you do not wish to immediately

repeat a new steam cooking cycle, it is recommended to empty the container refill it with fresh water, reinsert the container and close the door. The oven is now ready for a new cooking cycle.

If the electricity is interrupted, the oven requires you to empty the circuit once it turns back on, regardless of whether there is water in it or not.

CARE AND CLEANING

Replacing the oven light bulbs

Your oven uses G9 halogen bulbs with the specifications 220-240V, 50Hz and 25W.

Ensure the appliance is off before replacing the lamp to avoid the possibility of electric shock.

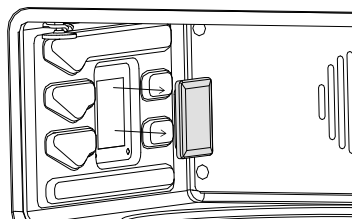

Remove the screws holding the steel frame.
Remove the old lamp by sliding it out of its socket and taking care not to break it.
Insert the new bulb taking care not to touch it with your hands (we recommend using a soft cloth to handle the bulb).

Replace the stainless steel frame taking care not to pinch the silicone gasket seal.

Re-insert the screws that were previously removed.

Re-connect the oven to power.

TROUBLESHOOTING

If there is a problem with your oven, please check the following, before contacting a Fisher & Paykel trained and supported service technician or Customer Care Centre.

| PROBLEM | POSSIBLE CAUSES / SOLUTION |
|------------------------------------------------------------------------------------------------|--------------------------------------------------------|
| Food browns unevenly. | Oven is not preheated. |
| | Aluminum foil on oven rack or oven bottom. |
| | Baking pan is too large for recipe. |
| | Baking pans are touching each other or oven walls. |
| Food too brown on bottom. | Oven is not preheated. |
| | Using glass, dull or darkened metal pans. |
| | Incorrect rack position. |
| | Baking pans are touching each other or oven walls. |
| Food is dry or has shrunk excessively. Food is baking or roasting too slowly. | Oven temperature too low. |
| | Oven not preheated. |
| | Oven door opened frequently during cooking. |
| | Food is tightly sealed with aluminum foil. |
| | Pan size too small. |
| Pie crusts do not brown on bottom or have soggy crust. | Baking time is not long enough. |
| | Using shiny steel pans. |
| | Rack position is incorrect. |
| | Oven temperature is too low. |
| Cakes pale, flat and may not be cooked inside. | Oven is temperature too low. |
| | Baking time is not long enough. |
| | The cake has been tested too soon. |
| | The oven door has been opened too often during baking. |
| | Baking pan size may be too large. |

TROUBLESHOOTING

| PROBLEM | POSSIBLE CAUSES / SOLUTION |
|----------------------------------------------------------------|--------------------------------------------------------------------------------------------------------------------------------------------------------------------------------------------------------------------------|
| Cakes high in middle with crack on top. | Baking temperature is too high. Baking time is too long. Baking pans are touching each other or oven walls. Rack position is incorrect. Baking pan size may be too small. Batter is over-mixed |
| Pie crust edges too brown. | Oven temperature too high. Edges of crust is too thin. |
| Other F__ Error appears in the display window. | Remove power and turn it back on again after a few seconds. If condition persists, note the code number (refer to 'Event logs') and contact Customer Care or a Fisher & Paykel trained and supported service technician. |
| The oven display won't turn on. | Turn off power at the main power supply, then turn the power back on. If this does not resolve the issue, call Customer care or Fisher & Paykel trained and supported service technician. |
| The cooling fan continues to run after the oven is turned off. | The fan will turn off automatically when the electronic components have cooled sufficiently. |
| Oven is not heating. | Check the circuit breaker or fuse box to your house. Check that power is being supplied to the oven. Make sure the oven temperature has been selected. |
| Oven is not cooking evenly. | Always reduce recipe temperature by 15°C when baking with FAN HEAT . |
| Oven light is not working properly. | Check that power is being supplied to the oven. Refer to the 'First use' section of this user guide. |
| Clock and timer are not working properly. | Make sure there is proper electrical power to the oven. |
| Excessive moisture. | Using the convection mode will eliminate any moisture in the oven. |
| Turning off demo mode. | To disable the function, press the arrows ◀ ▶ to enter the DEMO display page and select off. Confirm your selection by pressing ✓. |

MANUFACTURER'S WARRANTY AND SERVICE GUIDE

NZ



To access your Warranty and Service Guide

Scan the QR code with your smartphone to access your warranty and book a service, or view online at <https://www.fisherpaykel.com/nz/help-and-support/warranty-information>

AU



To access your Warranty and Service Guide

Scan the QR code with your smartphone to access your warranty and book a service, refer to your separate warranty and service book or view online at <https://www.fisherpaykel.com/au/help-and-support/warranty-information>

This product has been designed for use in a domestic (residential) environment. This product is not designed for any commercial use. Any commercial use by the customer will affect this products Manufacturer's Warranty.

Complete and keep for safe reference:

Model _____

Serial No. _____

Purchase Date _____

Purchaser _____

Dealer _____

Suburb _____

Town _____

Country _____

FISHERPAYKEL.COM

© Fisher & Paykel Appliances 2022. All rights reserved.

The models shown in this guide may not be available in all markets
and are subject to change at any time.

The product specifications in this guide apply to the specific products and
models described at the date of issue. Under our policy of continuous product
improvement, these specifications may change at any time.

For current details about model and specification availability in your country,
please go to our website or contact your local Fisher & Paykel dealer.

592827A 01.22