

Double DishDrawer Dishwasher, Tall, Sanitize

Series 9 | Contemporary

Stainless Steel



Wash one drawer while you load the other, with room in each drawer for full-size dinner plates.

- Designed to be installed under your benchtop, with recessed handles for a seamless look
- Six wash programs, as well as additional Quick wash, Sanitize and Extra Dry modifiers
- Flexible racking allows you to customize internal shelves to suit your needs

- Wi-Fi enabled and works with the SmartHQ™ app for remote control and notifications

DIMENSIONS

Height	34 - 36 3/8 "
Width	23 9/16 "
Depth	22 9/16 "

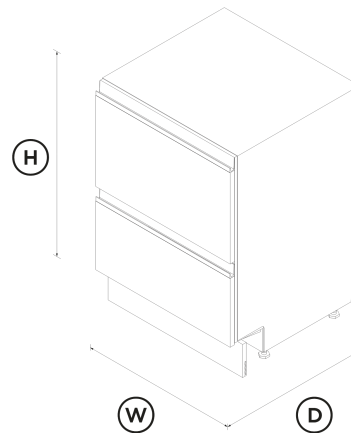

FEATURES & BENEFITS

Seamless Fit

Our built-under DishDrawer™ Dishwashers are installed flush under your benchtop with the option of a custom kickstrip, ensuring minimal gaps. The touch-sensitive control panel is located inside this model, leaving an uninterrupted exterior. Designed to match the Fisher & Paykel family of kitchen appliances with recessed handles for a streamlined look.

Ease Of Use

DishDrawer™ Dishwashers are as easy to open and close as kitchen drawers and can be conveniently positioned at bench height for ease of loading and minimal bending. Flexible racking allows you to make adjustments to fit in a variety of dishes.

Quick, Sanitize And Extra Dry Options

The Quick wash modifier delivers a faster wash while maintaining performance. The Sanitize option provides extra protection, killing 99.9% of bacteria* in the final rinse. The Extra Dry setting is perfect for plastic dishes.

True Half Load

Each drawer holds a true half load for small, fast washing that won't waste water. Both drawers operate independently so two wash cycles can operate simultaneously to allow for varying loads.

Knock To Pause

For ease-of-use, these DishDrawer™ Dishwashers have a knock to pause function. A knock on the front panel will pause the dishwasher, which can be restarted by using the start button.

Independent Wash

With the ability to use both drawers independently and select different wash programs, the DishDrawer™ Dishwasher can wash everything from fine glass and crystal to heavily soiled pots and pans.

Quiet Performer

Running at a very low decibel rating, these DishDrawer™ Dishwashers do their job without making a fuss. The combination of intelligent technology and simple mechanics means greater reliability and excellent wash performance.

SPECIFICATIONS

Accessories (included)

Cutlery basket	•
Kickstrip	true
Knife clip and multipurpose clip	•

Features	
Fan assisted drying	•
Flood protection	•
Flow through detergent dispenser	•
Motor type	BLDC
Quiet operation	•
SmartDrive™ technology	•

Quick	•
Sanitise	•
Wash modifiers	3

Capacity and loading

Accommodates round plates up to	12.25" (top) 11" (bottom)
Adjustable height, foldable cupracks	•
Fold down tines	•
Pitch adjustable tines	•
Place settings	14
Place settings	14
Place settings per drawer	7
Place settings per drawer	7

Performance	
Noise on standard cycle top drawer	42 dBA

Wash Programs

Delicate	•
Eco	•
Fast	•
Heavy	•
Medium	•
Rinse	•
Wash programs	6

Power requirements

Amperage	10A
Supply frequency	60Hz
Supply voltage	100 - 120V

Water connection

Supplied hose to suit 3/8" (9mm) male compression fitting	•
Water pressure	30kPa - 1000 kPa

Consumption

Energy usage	265kWh/year
In-use energy carbon emissions estimate	32.7kgCO2e/year
Water usage (per wash cycle)	3.28 gal running both tubs

Product dimensions

Depth	22 9/16 "
Height	34 - 36 3/8 "
Width	23 9/16 "

SKU	82901
-----	--------------

Controls

Energy saving delay start option of up to 12 hours	•
Keylock	•
Knock to pause	•
Rinse aid indicator light	•
Smart appliance	•
Wi-Fi connectivity	•

Warranty

Parts and labor	Limited 2 years
-----------------	------------------------

Wash Program Modifiers

Extra Dry	•
-----------	---

The product dimensions and specifications in this page apply to the specific product and model. Under our policy of continuous improvement, these dimensions and specifications may change at any time. You should therefore check with Fisher & Paykel's Customer Care Centre to ensure this page correctly describes the model currently available. © Fisher & Paykel Appliances Ltd 2020

Other product downloads available at fisherpaykel.com

- [↓](#) Energy Label Double DishDrawer™ Dishwasher
- [↓](#) Service & Warranty
- [↓](#) Installation Guide DishDrawer™ Dishwasher
- [↓](#) Guide d'installation FR
- [↓](#) Preliminary Specification Guide Double DishDrawer™ Dishwasher
- [↓](#) User Guide EN / Guide d'utilisation FR
- [↓](#) Wash Program Data DishDrawer™ Dishwasher EN

Where applicable:

All appliances use energy, and energy usage typically generates carbon emissions. **Fisher & Paykel Appliances' In-use Energy Carbon Emissions Estimate** indicates carbon emissions from a product's in-use energy. This is calculated either annually or per cycle, using the product's market-specific energy label energy consumption data multiplied by the carbon emissions factor for energy in your country or region.

Our In-use Energy Carbon Emissions Estimate is designed to assist customers in making informed purchasing decisions when comparing different Fisher & Paykel products. For example, a heat pump dryer typically has a lower In-use Energy Carbon Emissions Estimate than a vented dryer.



A PEACE OF MIND SALE
24 Hours 7 Days a Week Customer Support
T 1.888.936.7872 W www.fisherpaykel.com