

FISHER & PAYKEL

**ACTIVESMART™ REFRIGERATOR,
VERTICAL REFRIGERATOR
AND VERTICAL FREEZER**

**RF331T, RF381T, RF411T, RF440T, RF521T,
RF373, RF450, E450, RF308, RF388 & E388 models**

INSTALLATION GUIDE / USER GUIDE

NZ AU HK SG

CONTENTS

Model numbers	2
Introduction	3
Safety and warnings	4
Installation instructions	7
Moving or storing your appliance	13
ActiveSmart™ operating instructions	14
ActiveSmart™ special features	16
Activesmart™ cleaning care instructions	19
ActiveSmart™ user warnings and sounds	23
Vertical Refrigerator operating instructions	24
Vertical Refrigerator special features and maintenance	25
Vertical freezer operating instructions	26
Storing food in your refrigerator	27
Troubleshooting	28
Service & Warranty	32

IMPORTANT!

SAVE THESE INSTRUCTIONS

The models shown in this User guide may not be available in all markets and are subject to change at any time. For current details about model and specification availability in your country, go to our website fisherpaykel.com or contact your local Fisher & Paykel dealer.

Registration

Register your product with us so we can provide you with the best service possible.

To register your product visit our website: fisherpaykel.com

MODEL NUMBERS

ACTIVESMART™ REFRIGERATOR MODELS

635mm wide RF331T, RF381T, RF411T

680mm wide RF440T

790mm wide RF521T

VERTICAL REFRIGERATOR MODELS

635mm wide RF373, RF450, E450

VERTICAL FREEZER MODELS

635mm wide RF308, RF388, E388

INTRODUCTION

Thank you for buying a Fisher & Paykel ActiveSmart™ refrigerator.

At Fisher & Paykel we are very proud of this refrigerator. This refrigerator combines size and storage space with the latest features and functions.

Thousands of hours of food care research and refrigeration experience has been programmed into your refrigerator to give you the best possible performance.

We hope you enjoy your new refrigerator.

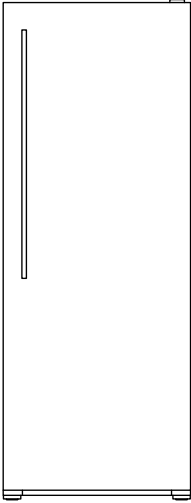

RF450
refrigerator

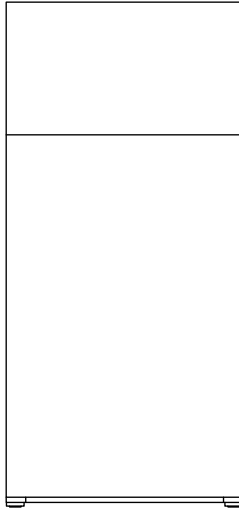

RF521T
refrigerator

Note: this guide covers all models listed on previous page.
Diagrams above show examples of two of the models covered in this book.

ActiveSmart™ refrigerators have two handle options, shown below.

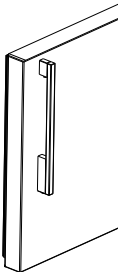

Designer handles

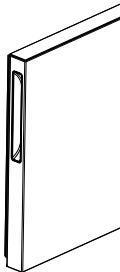

Recessed handles

SAFETY AND WARNINGS

WARNING!



Electric Shock Hazard

Read and follow the safety and warnings outlined in this User guide before operating this appliance.

Failure to do so can result in death, electric shock, fire or injury to persons.



R600a

This refrigerator may contain flammable refrigerant isobutane (R600a).

Use this appliance only for the intended purpose as described in the User guide.

IMPORTANT SAFETY INSTRUCTIONS:

WARNING!

When using this appliance always exercise basic safety precautions including the following:

- Children should be supervised to ensure that they do not play with the appliance.
- Cleaning and user maintenance shall not be made by children without supervision.
- This appliance can be used by children aged from 8 years and above and persons with reduced physical, sensory or mental capabilities or lack of experience and knowledge if they have been given supervision or instruction concerning use of the appliance in a safe way and understand the hazards involved.
- The manufacturer's installation instructions for product and cabinetry ventilation must be followed when installing the appliance.
- To avoid hazard due to instability of the appliance, it must be fixed in accordance with installation instructions.
- Keep ventilation openings, in the appliance enclosure or the built-in structure, clear of obstruction.
- Do not use mechanical devices or other means to accelerate the defrosting process, other than those recommended by the manufacturer.
- Do not damage the refrigerant circuit.
- In case of damage to the refrigerant circuit, ventilate the area by opening all windows. Do not operate electrical equipment or any other equipment that may produce arcs, sparks or flames in the area. Contact your Fisher & Paykel trained and supported service technician immediately to arrange for the appliance to be repaired.
- It is hazardous for anyone other than a Fisher & Paykel trained and supported service person to service this appliance. In Queensland the service person must hold a gas work licence or authorisation for hydrocarbon refrigerants to carry our service or repairs which involve removal of covers.

SAFETY AND WARNINGS

Electrical

- This appliance must be installed in accordance with the installation instructions before use.
- To allow disconnection of the appliance from the supply after installation, incorporate a switch in the fixed wiring in accordance with the local wiring rules.
- Never unplug your refrigerator by pulling on the power cord. Always grip the plug firmly and pull straight out from the outlet.
- Do not plug in any other appliance at the same power point as your refrigerator or use extension cords or double adapters.
- Repair or replace immediately all electric service cords that have become frayed or otherwise damaged. Do not use a cord that shows cracks or abrasion along its length or at either the plug or appliance end.
- If the power supply cord is damaged, it must only be replaced by your Fisher & Paykel trained and supported service technician.
- When moving your appliance away from the wall, be careful not to roll over or damage the power cord.

WARNING!

Do not use electrical appliances inside the food storage compartments of the appliance, unless they are of the type recommended by the manufacturer.

IMPORTANT!

Your refrigerator is designed to operate for many years without the need for service checks. However, if your refrigerator is malfunctioning, have it attended to by your Fisher & Paykel trained and supported service technician as soon as possible. All electrical repairs must be carried out by an adequately trained service technician or qualified electrician.

Cleaning

- Use only soap based cleaning products.
- Many commercially available cleaning products contain solvents that may attack the plastic components of your refrigerator and cause them to crack.
- Avoid using anti-bacterial cleaning products on either the interior or exterior of the cabinet as they may cause rusting of metal components and cracking of plastic components.
- Refer to the 'Cleaning care instructions' section of this User guide for your particular model for further information.

Disposal

- Extreme care must be taken when disposing of your old appliance to avoid hazards:
 - The flammable refrigerant gas must be safely removed by a qualified service technician.
 - The thermal insulation foam in this appliance may contain flammable insulation blowing gases, any exposed foam may be highly flammable and must be carefully treated during disposal.
 - **DANGER:** The doors and panels should be removed and the shelves left in place so that children may not easily climb inside.
- Consult your local energy authority or local codes as to the best way to dispose of your old appliance.
- Your Fisher & Paykel trained and supported service technician will be able to give advice on environmentally-friendly methods of disposing of your old refrigerator or freezer.

SAFETY AND WARNINGS

Storing food and drinks

- **Do not store explosive substances such as aerosol cans with a flammable propellant in this appliance.**
- **Never store volatile or flammable materials in your refrigerator as they may explode.**
- **Never freeze liquids in glass containers. Liquid expands during freezing, which may cause the container to explode.**
- **Never freeze carbonated drinks. They may explode.**

INSTALLATION INSTRUCTIONS

Before installation

IMPORTANT!

- **The appliance has front and rear rollers for moving the appliance forward and backward. Do not move the appliance sideways to avoid damaging the rollers or the floor covering/surface.**
- **Connection to electrical power and earthing must comply with local codes and ordinances and be made by licensed personnel when required. Avoid installation of the appliance/s under a ground fault circuit interrupter (GFCI).**
- **Ensure the appliance is installed properly. Improper installation that results in appliance failure is not covered under the appliance warranty.**

Check the installation location. Check the cabinetry. If using a kit to integrate your product then check the dimensions of the cabinetry (width, depth, height, floor level, finished alcove returns). Ensure that the ventilation openings in the cabinetry are clear of obstruction.

Check the power supply connection

- Ensure that there is a separate power socket for each appliance.
- Avoid sharing the power point with other appliances to prevent accidental switching off of the appliance.
- For power requirements, please refer to the information on the serial plate.
- Ensure your appliance is properly grounded (earthed).
- Connect your appliance to an electrical supply with the fitted plug and lead.
- The appliance must be installed so the plug is accessible. For integrated appliance (using our optional integration kit system) then we recommend to use an isolating switch that is easily accessible to the user after the appliance is installed.
- Follow local codes and ordinances when installing the appliance.

Check your appliance

- Ensure that your appliance is the correct model as per your order.
- Check that the packaging is not damaged upon delivery.
- Ensure the components listed are complete.

IMPORTANT!

- **Be careful when unpacking to prevent damage to the surface of your appliance.**
- **Ensure that the appliance is stable to prevent it tipping when unpacking.**

INSTALLATION INSTRUCTIONS

Product and cabinetry dimensions

If integrating your refrigerator, please follow installation instructions provided with the integration kits.

RF373, RF450, E450, RF308, RF388, E388, RF331T, RF381T, RF411T, RF440T, RF521T

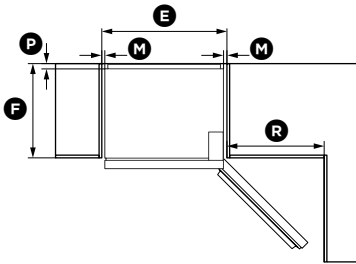
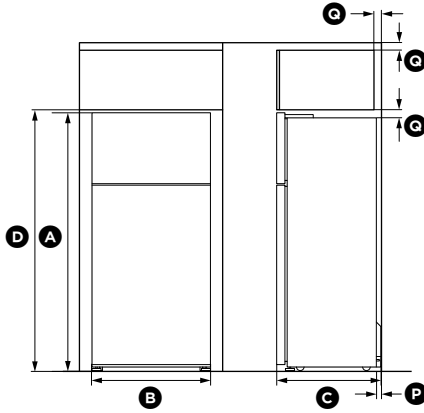

Flush with refrigerator chassis—full door rotation

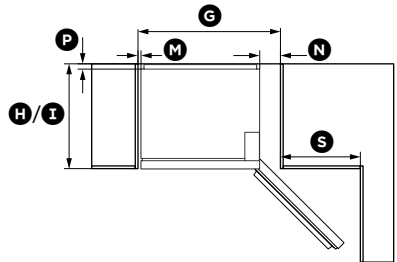

Flush with refrigerator door—full door rotation

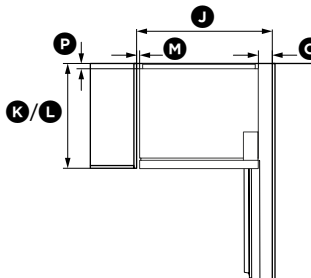

Flush with refrigerator door—90° door rotation

INSTALLATION INSTRUCTIONS

	RF373 RF308	RF450 RF388	RF331T	RF381T	RF411T	RF440T	RF521T	
PRODUCT DIMENSIONS								mm
(A) Overall height of flat door product	1425	1695	1425	1595	1695	1695	1695	
(B) Overall width of product	635	635	635	635	635	680	790	
(C) Overall depth of flat door product (excludes handle, includes evaporator)	695	695	695	695	695	695	695	
CABINETRY DIMENSIONS (including minimum clearances)								mm
(D) Inside height of cavity	1475	1700- 1735*	1465	1635	1700- 1735*	1700- 1735*	1700- 1735*	
Flush with refrigerator chassis – full door rotation								
(E) Inside width	675	675	675	675	675	720	830	
(F) Inside depth	620	620	620	620	620	620	620	
Flush with refrigerator door – full door rotation								
(G) Inside width	790	790	790	790	790	835	945	
(I) Inside depth flush to door	-	695	695	695	695	695	695	
Flush with refrigerator door – 90° door rotation (for full drawer/shelf access, the doors need to be open past 90°)								
(J) Inside width	745	745	745	745	745	790	900	
(L) Inside depth flush to door	-	695	695	695	695	695	695	
Note: Alternative installation can cause some restriction to the refrigerator's air supply and reduce its optimum energy performance level. *1735 is recommended to provide the best ventilation								
MINIMUM CLEARANCES								mm
(M) Side clearance	20	20	20	20	20	20	20	
(N) Side clearance – hinge side flush with door – full rotation	135	135	135	135	135	135	135	
(O) Side clearance – hinge side flush with door – 90° rotation	90	90	90	90	90	90	90	
(P) Rear clearance (including evaporator tray)	30	30	30	30	30	30	30	
(Q) Vent (above refrigerator cabinet or around top of cupboard)	50	50	50	50	50	50	50	
(R) Door clearance – hinge side flush with chassis – full rotation	520	520	520	520	520	555	645	
(S) Door clearance – hinge side flush with door – full rotation	405	405	405	405	405	440	530	

INSTALLATION INSTRUCTIONS

Installation

Your Fisher & Paykel refrigerator is fitted with front and rear rollers, designed for moving the product in the forwards and backwards direction.

Avoid moving the product in a sideways direction as this may damage the rollers or the floor covering/surface.

- ① Your refrigerator will arrive with the front feet wound up making moving the product into its final location a simple task.
- ② Roll the refrigerator into its final position making sure there is the correct air gap between the product and surrounding cabinetry. See minimum clearance in cabinetry dimensions table.
- ③ Adjust the front feet down until the refrigerator is leaning backward with the front approximately 10mm higher than the back. This will ensure a good door closing action.
- ④ Aligning your refrigerator with cabinetry.
 - a Align the sides of the refrigerator with the cabinetry by adjusting the hinge side front foot.
 - b Adjust the handle side foot until it touches the floor and takes a small amount of weight.
 - c Once the refrigerator is in place and aligned with cupboards/alcove gently push on the front top and check if the product is rocking or stable.

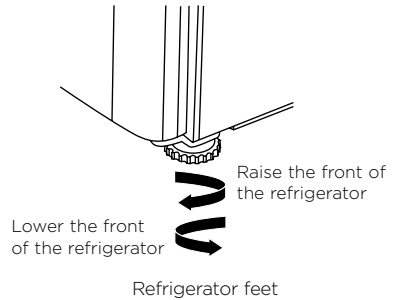

INSTALLATION INSTRUCTIONS

What to do if your product is unstable

- ⑤ Gently push the refrigerator back until the rear rollers contact the floor.
- Measure the gap under the front foot, which has come off the floor.
 - Obtain some solid packing material (hardwood, plastic, etc) which fits firmly into the gap under the foot.

Note: do not use metallic materials that may corrode, stain and/or damage floor coverings.

- ⑥ Wind both front feet up and roll the product out of position.
- Place the packing material in the location diagonally opposite the front roller that lifts off the floor.
 - Make sure the packing material stays in place when the product is pushed back into position.
 - Ideally, the packing material is large enough to rest against the back wall so as to prevent it from moving when the cabinet is pushed into position.

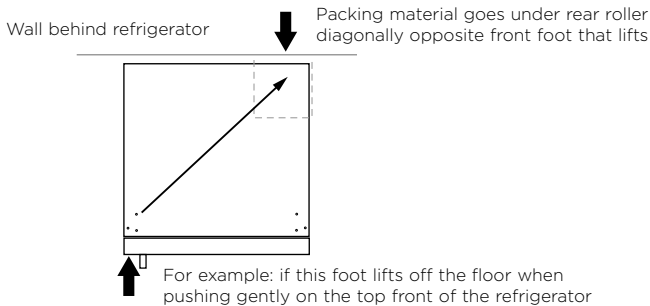
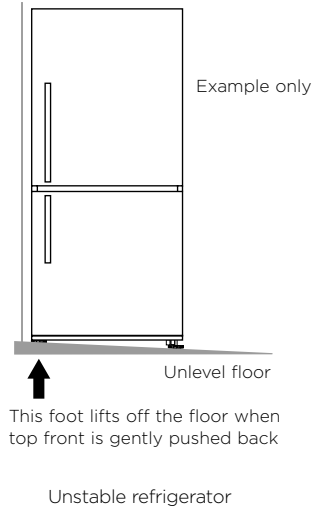

Stabilising your refrigerator

- ⑦ Roll the refrigerator back into position and adjust front feet as per step ③. (Check alignment and door closing action are satisfactory).
- Make small adjustments to front feet where necessary.
 - Check that the product is stable (all four feet are on the floor).
- If not, repeat steps ④ c, ⑤ and ⑥.

INSTALLATION INSTRUCTIONS

Before placing food in the fresh food or freezer compartments

- Remove all internal packaging. Ensure that all transit clips are removed from the refrigerator. These are small rubber stoppers located at the back of the shelves.
- Clean the inside of the appliance with a mix of warm water and a small amount of liquid detergent, and a soft cloth to remove manufacturing and transportation dust.
- Allow the refrigerator and freezer to run empty for 2–3 hours to allow each compartment to cool to the appropriate temperature.
- The appliance may have an odour on its initial operation, but this will go when the refrigerator and freezer have cooled sufficiently.

Energy efficiency

For the most energy efficient use of your appliance:

- Ensure your refrigerator has adequate ventilation.
- Do not cover your appliance with any material that will prevent air from flowing around the cabinet sides.
- Ensure you vacuum around the appliance to remove dust and possible pet hair accumulation. Also keep the appliance and its cabinetry free of dust by wiping down with a dry, lint-free cloth (refer to sections 'Cleaning care instructions', 'Cabinet surround' for your specific model).
- Allow good clearances in front of air ducts within the cabinet for maximum cold air distribution.
- Cool hot foods before placing them in the appliance.
- Do not overfill the compartments.
- Keep door openings to a minimum.
- Select a temperature setting that isn't too cold.
- Check your door seals for leaks.

MOVING OR STORING YOUR APPLIANCE

If your refrigerator is turned off for any reason, wait 10 minutes before turning it back on. This will allow the refrigeration system pressures to equalise before restarting.

Moving your refrigerator

- Turn off the appliance and unplug from the power point. Remove all food.
- Turn the adjustable feet to the right as far as they will turn.
- Ease the refrigerator out of its position. Tuck the power cord away, tape the shelves in place and tape the doors closed. If the cabinet needs to be placed at an angle or laid down, carefully lay it on its side (the right hand side when viewed from the front).
- Relocate and install. If the appliance has been left on its side for any length of time, leave it standing upright as long as you can (a few hours) before turning on.

Storing your refrigerator

- When storing your cleaned appliance, leave the doors open. This allows air to circulate and prevents the build up of bacteria and moulds.
- Before using again, clean well using a mixture of warm water and a small amount of liquid dishwashing detergent. Rinse with clean water and dry with a soft lint-free cloth.

Holiday time

We recommend you leave your refrigerator operating while you are on holiday.

ACTIVSMART™ OPERATING INSTRUCTIONS

Models:	635mm wide	RF331T, RF381T, RF411T
	680mm wide	RF440T
	790mm wide	RF521T

The control panel enables you to view and modify features and options on your refrigerator.

Temperature control

- When the refrigerator is first turned on, the powerful cooling system will automatically cool both refrigerator and freezer compartments to their set temperatures. This will take between 2–3 hours.
- The two compartment temperatures are accurately and independently controlled and do not change with the temperature or humidity of the surroundings; whether summer or winter.
- If you wish to alter the temperature of either the fresh food compartment or freezer compartment, this can be easily done by using the internal control panel located on the back wall of the refrigerator compartment.



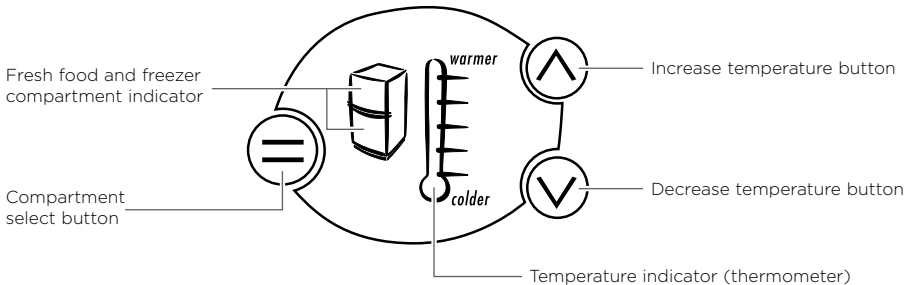

Control panel (to adjust temperatures)



Fresh food compartment

- The fresh food compartment light will automatically be illuminated. The temperature for this compartment will show as a series of lights.
- The temperature may be altered by pressing the \wedge or \vee buttons. One press on either of these buttons will reduce or increase the number of lights by one which indicates a small change in temperature.
- Fewer lights illuminated means a cooler temperature for the compartment selected.

Freezer food compartment

- To adjust the freezer temperature press the  button so the freezer compartment light is illuminated.
- The freezer temperature can be altered by pressing the  or  buttons.
- One press on either of these buttons will reduce or increase the number of lights illuminated which indicates a small change in temperature.
- Fewer lights illuminated means a cooler temperature for the compartment selected. Note: successively pressing the  button will automatically scroll between the compartments.
- When the door is re-opened the control panel will return automatically to the fresh food compartment setting.

Door alarms

- If the fresh food compartment door is left open the alarm will beep after 90 seconds and if the freezer door is left open the alarm will beep after 60 seconds.
- While either door remains open, subsequent beeps will sound every 30 seconds for 5 minutes.
- A continuous alarm will sound if either of the doors have been left open for 5 minutes or longer and the interior compartment light(s) will turn off. The alarm will stop only when the door(s) is closed.

Sabbath mode

- To activate Sabbath mode, open both the fresh food and freezer compartment doors and then hold the  button on the temperature control panel for 10 seconds.
- Both the fresh food and freezer compartment indicators will be illuminated indicating the refrigerator is in Sabbath mode.

When the product is in Sabbath mode:

- The fresh food and freezer compartment indicator lights will be illuminated.
- The light will not operate when the door is opened.
- The door alarm will not operate.
- The display will not function except to indicate Sabbath mode is active as stated above.
- Opening the door will not affect the compressor or fans.
- If the power to the refrigerator is turned off whilst in this mode, the product will continue in Sabbath mode when the power is restored.
- Sabbath mode will automatically de-activate 80 hours after activation.
- To de-activate earlier than 80 hours hold the  button on the temperature control panel for 10 seconds.

ACTIVESMART™ SPECIAL FEATURES

Manual ice system (selected models only)

An ice storage bin which sits inside the upper top freezer bin provides storage for and gives you access to clean, clear ice cubes.

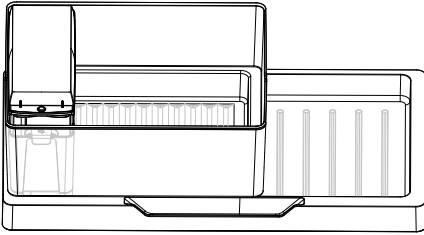

Upper left freezer bin, ice storage bin, ice tray, lid and scoop in correct position

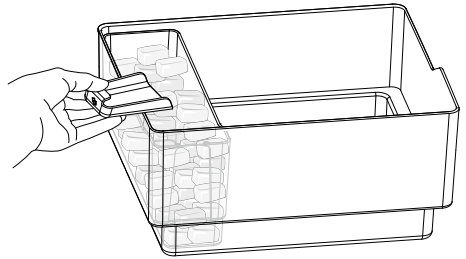

Accessing your ice

Information about your manual ice system

- To make ice, take the ice tray and lid from the top of the ice storage bin. Remove the lid from the ice tray and fill the tray with water. Place the lid back on the ice tray and carefully position it back onto the ice storage bin.
- Once the ice is solid, take the ice tray and lid off the ice storage bin, remove the lid from the tray and twist the ice tray at each end in opposite directions. Turn the ice tray over the ice storage bin to dislodge the cubes into the bin.
- Fill the ice tray with clean water and repeat to fill the ice storage bin.
- Attached to the ice storage bin is the ice scoop which provides hygienic access to ice.
- To access ice cubes, take the ice tray and lid from the top of the ice storage bin and place onto a flat surface. Take the scoop from the front of the bin, scoop cubes into vessel and then replace the scoop, tray and lid back to the top of the bin.
- For maximum ice storage, level the stored cubes around the bin with the ice scoop.
- If ice is not used often, old cubes will become cloudy, taste stale, will shrink and may stick together. Empty the ice storage bin periodically and wash in lukewarm water. Dry thoroughly and place back in the correct position.

Fruit and vegetable bins and humidity control lid

The fruit and vegetable bins feature a unique lid which provides two functions:

- The humidity lid seals the bins and provides a humid microclimate to extend storage times of fruit and vegetables.
- The humidity lid prevents condensation, which forms at high humidities, from dripping down onto the fruit and vegetables by retaining it in the grooves of the lid.

Fruit and vegetable bins and humidity slide (selected models only)

- Each fruit and vegetable bin has a humidity slide control that can be adjusted to a fruit or vegetable setting depending on what is stored in the bins.
- If possible try to store fruit and vegetables separately. This will help extend their storage life.
- If there is a mixture of fruit and vegetables in the bin adjust the position of the control to the centre.
- If there is too much water in the bins (due to the high humidity in the bins), the control can be adjusted towards the setting with fewer drips (fruit setting) and/or the water can be wiped out as required.
- Remember a minimum amount of water in the bins is beneficial for fruit and vegetable storage.

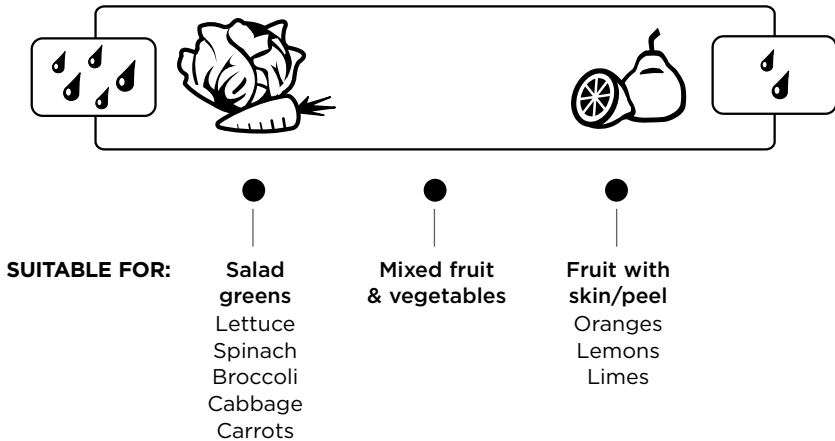

Humidity control graphic

Vegetable bin divider instructions (where fitted)

To fit the divider, insert divider into bin on an angle, straighten and slot into place. To adjust the divider, fully extend the bin, partially lift the divider, slide sideways and re-slot into position.

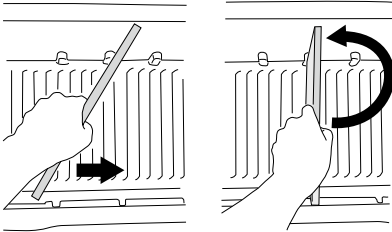

Vegetable bin divider

Bottle holder (where fitted)

- The bottle holders can be used to store a variety of bottles.
- To position the bottle holder in your refrigerator, simply slot the back edge of the bottle holder onto the back trim of any shelf in the fresh food compartment.
- If you are not using all or some of the bottle holders, the unused bottle holders can be stacked up on top of one another so they do not take up unnecessary shelf space.
- Bottles are best stored with the neck of the beverage facing the front of the refrigerator.

Glass shelves

- Glass shelves can be repositioned in the cabinet as desired.
- Remove shelves by lifting up the back of the shelf and then pulling the shelf forward.

Exterior

Stainless exterior doors

- Clean the exterior door with liquid dishwashing detergent dissolved in warm water and a soft cloth.
- Dry the door with a lint-free cloth.
- The use of any abrasive or stainless steel cleaners and solvents will damage the door surface.

Other exterior surfaces

- Clean all other exterior surfaces with a mix of warm water and liquid dishwashing detergent, and a soft cloth.
- If necessary, clean the magnetic door gasket, the centre door gasket and the recessed handles with an old toothbrush, warm water and liquid dishwashing detergent.

Cabinet surround

- To maximise operating efficiency regularly vacuum the flooring around your appliance.
- Cleaning behind the appliance is required once or twice a year. More frequent cleaning may be necessary for dusty homes or those with pets shedding hair.
- To do this wind up the feet and carefully ease the refrigerator out of its position. Switch off and unplug.
- Vacuum the flooring behind your appliance to remove dust accumulation. Use a dry lint-free cloth to clean the appliance walls and surrounding cabinetry.
- After cleaning, plug in and switch on. Push the appliance into position and wind feet down.

WARNING!

Electric Shock Hazard. Do not remove rear compartment cover. This may expose you to the risk of an electric shock.

Water evaporator tray

- The water evaporator tray is found above the compressor at the back of the refrigerator or freezer. The tray may require infrequent cleaning.
- Carefully move the refrigerator or freezer out from the wall.
- Switch off the appliance.
- We do not recommend that you remove the evaporator tray. If cleaning is required, excess water can be soaked up from the evaporator tray using a sponge. Wipe out with warm water and detergent or disinfectant.
- Switch on the appliance and reposition the refrigerator.

Interior

- It is important to keep the interior of the refrigerator and freezer clean to help prevent food from becoming contaminated during storage.
- The amount and types of food stored determines how often cleaning should be carried out in the refrigerator (ideally once every 1-2 weeks).
- Remove the shelves from cabinet and door. Wash shelves and storage bins in warm water and detergent; rinse in clean water and dry before replacing.
- Wipe over the interior surfaces with warm water and liquid dishwashing detergent. Alternatively you can use 1 tsp baking soda dissolved in 500ml of warm water. Rinse with clean water.
- To help remove “old stale refrigerator” smells add a few drops of vanilla essence or vinegar to the water before cleaning.
- Clean interior surfaces with warm water and liquid dishwashing detergent. Use a toothbrush for the magnetic door gasket.
- Do not use harsh, abrasive cloths on any part of the refrigerator or freezer.

Glass shelves

Clean with warm water and detergent or a glass cleaner.

Bottle holder (where fitted)

Clean with warm water and detergent. The use of abrasive cleaners and solvents may cause damage.

IMPORTANT!

Many commercially available cleaning products contain solvents that may cause damage such as cracking to the plastic components of your refrigerator. It is important to use only warm water and a small amount of liquid dishwashing detergent on any components inside and outside your refrigerator. Avoid using anti-bacterial cleaning products on either the interior or exterior of the cabinet as they may cause rusting of metal components and cracking of plastic components.

Humidity Control System (where fitted)

IMPORTANT!

When cleaning the shelf above the vegetable bins, we recommend that you do not disassemble the Humidity Control System from the shelf.

In the event that the humidity control lid (plastic lid) and humidity slides become separated from the glass shelf, follow these instructions to reassemble.

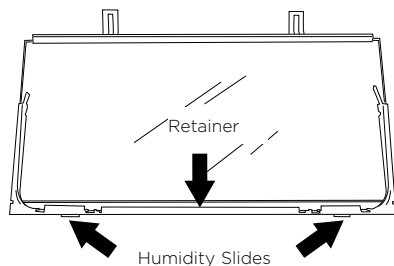

- ① Turn shelf upside down.

- ② To attach humidity slides onto shelf front corners, fit bottom clips into shelf front trim. Next, slide sideways towards shelf until arm clips onto glass.

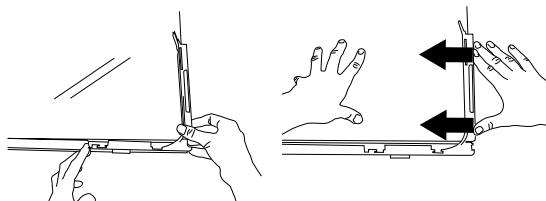

- ③ To attach humidity control lid— with text facing you, align lid with front of shelf. Hold lid vertically and fit front end into retainer on shelf. Ensure lid fits into retainer as well as underneath humidity slides.



- ④ At the sides of the shelf, adjust humidity slide tabs so that the plastic lid is between the shelf and the tabs.

- ⑤ If clips on back of shelf are present, fasten lid with rear clips. Ensure that the cover is fully secure at front and back of shelf.

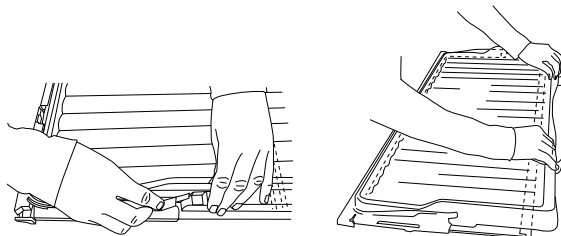

Humidity Control System cleaning

ACTIVESMART™ CLEANING CARE INSTRUCTIONS

To remove trays or fixed bins (selected ActiveSmart™ models only)

- For ease of removal, empty food from tray/bin first.
- Hold the centre front of the tray/bin handle.
- Lift vertically to unclip from the runners and pull tray/bin towards you to remove.
- Push both runners back into refrigerator.

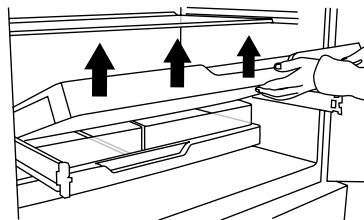

Tray removal

To replace trays or fixed bins

With the runners pushed back into the refrigerator, place the tray/bin on top of the runners. Push the tray/bin back slowly until you feel it clip back onto the runners.

IMPORTANT!

- **Ensure that trays and bins are securely clipped onto the runners before use.**
- **Bin and tray runners are pre-lubricated, and will not need to be re-lubricated during their life. Do not attempt to clean grease from the runners, as this will affect their ability to function. Do not immerse runners in water.**

On vacation/holiday

We recommend you leave your refrigerator or freezer operating while you are on holiday.

User warnings

Fault alarms

- If the electronic controller detects a fault from which it is unable to recover an alarm will sound.
- When the fresh food compartment door is opened a fault code (specific pattern of lights) will flash red and green on the control panel to alert you to the fault. The audible alarm will stop when any button is pressed but the lights will remain flashing. If such a fault occurs, call your Fisher & Paykel trained and supported service technician immediately; the fault code will help the service person find and remedy the cause of failure.

Normal refrigerator sounds

ActiveSmart™ refrigerators, with their excellent energy ratings and cooling performance, can produce sounds somewhat different to your old refrigerator.

Normal operational sounds include:

- Fan air flow sound. ActiveSmart™ refrigerators have fans which change speed depending on demand. During cooling periods, such as after frequent door openings, fans circulate the cold air in the refrigerator and freezer compartments producing some air flow sound. This is quite normal.
- Cracking or popping which may occur when the defrost function is operating.
- Running water sound. This is the liquid refrigerant in the system and can be heard as a boiling or gurgling noise.
- An audible hissing sound after closing the freezer door. This is due to the pressure difference between the warm air that has entered the cabinet and suddenly cooled, and the outside air pressure.
- Other sounds may be heard for the following reasons:
 - Cabinet not level.
 - Floor uneven or weak.
 - Bottles or jars rattling on shelves.

VERTICAL REFRIGERATOR OPERATING INSTRUCTIONS

Models: 635 mm wide RF373, RF450, E450

Temperature control

- The control has been factory set for normal operating conditions.
- Allow the refrigerator to run empty for 2–3 hours before placing food inside the fresh food or freezer compartments.
- Re-adjust the control as necessary to suit your individual preference.

1 is warmest setting

7 is coldest setting

- We recommend adjusting the temperature by half a setting initially and then allow at least 24 hours for the cabinet temperature to stabilise before re-adjusting.
- The running time and temperature are affected by where your refrigerator is located, how often the door is opened and the temperature of the room the refrigerator is located in. Your refrigerator is designed to operate in a room temperature of between 10°C and 43°C.

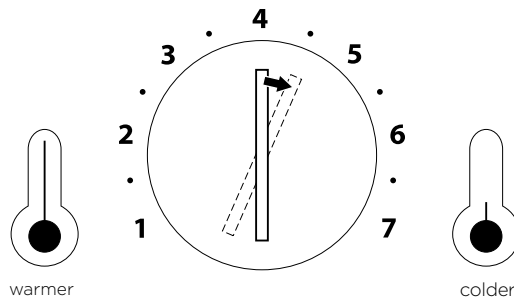

VERTICAL REFRIGERATOR SPECIAL FEATURES AND MAINTENANCE

Door alarms

- If the fresh food compartment door is left open the alarm will beep after 90 seconds.
- If the door remains open, subsequent beeps will sound every 30 seconds for 5 minutes.
- A continuous alarm will sound if the door has been left open for 5 minutes or longer.
- The alarm will stop when the door is closed.

Fault alarms

- If the electronic controller detects a fault from which it is unable to recover, an alarm will sound when the door is opened.
- When the fresh food compartment door is opened and a fault has occurred, a specific number of beeps will sound. If a fault occurs, call your Fisher & Paykel trained and supported service technician immediately; the number of beeps will help the service person find and remedy the cause of failure.

Humidity control lid

The fruit and vegetable bins feature a unique lid which provides two functions:

- The humidity control lid seals the bins to provide a humid microclimate to extend storage times of fruits and vegetables.
- The humidity control lid prevents condensation, which forms at high humidities, from dripping down onto the fruit and vegetables by retaining it in the grooves of the lid.

The ability to retain high humidity in the fruit and vegetable bin may produce small amounts of water in the bottom of the fruit and vegetable bin. This can be wiped out as required.

Replacement of interior light

- Turn the power off at the wall before replacing the LED lamp.
- The interior lamp is located on the right-hand side of the temperature control box and is removed by sliding the cover outward.
- Replace lamp, making sure it is tightly pushed in. Switch the power back on.
- The replacement lamp must not exceed 2.5 Watts. Lamps are available from your Fisher & Paykel trained and supported service technician or through the Customer Care Centre.

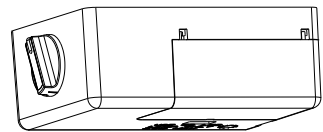

IMPORTANT!

Your refrigerator is designed to operate for many years without the need for frequent service checks. However, if your refrigerator is malfunctioning, have it attended to by your Fisher & Paykel trained and supported service technician as soon as possible. All electrical repairs must be carried out by an adequately trained service technician or qualified electrician.

VERTICAL FREEZER OPERATING INSTRUCTIONS

Models: 635mm wide RF308, RF388, E388

Temperature control

- The cabinet control is located at the bottom rear of the cabinet.
- The control has been factory set to position '4' for normal operating conditions.
- The freezer temperature should be approximately -18°C.
- Re-adjust the control as necessary to suit your individual preference.

1 is the warmest setting.
7 is the coldest setting.

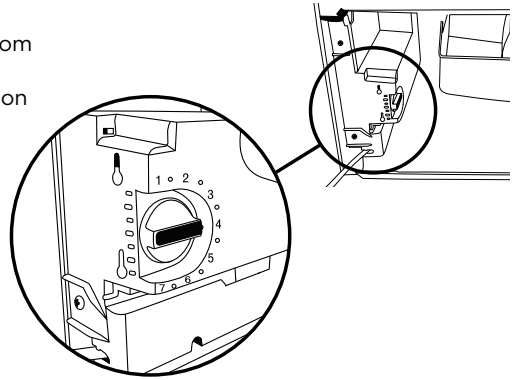

Door alarms

- If the door is left open the alarm will beep after 60 seconds.
- If the door remains open, subsequent beeps will sound every 30 seconds for 5 minutes.
- A continuous alarm will sound if the door has been left open for 5 minutes or longer.
- The alarm will stop when the door is closed.

Fault alarms

- If the electronic controller detects a fault from which it is unable to recover, an alarm will sound when the door is opened.
- When the door is opened and a fault has occurred, a specific number of beeps will sound.
- If a fault occurs, call your Fisher & Paykel trained and supported service technician immediately; the number of beeps will help the service person find and remedy the cause of failure.

STORING FOOD IN YOUR REFRIGERATOR

Your refrigerator helps to extend the storage times of fresh perishable foods. The cold temperature slows down the major causes of food spoilage—namely, the growth of bacteria, moulds and yeasts, and any chemical and physical reactions.

Fresh food care

The quality of food before it is placed in the refrigerator is critical to successful storage.

For best results

- Select foods that are very fresh and of high quality.
- Buy only the amount that you will use within the recommended storage time. If you buy extra, plan to freeze it.
- Ensure that food is well wrapped or covered before it is stored. This will prevent food from dehydrating, deteriorating in colour or losing flavour and will help maintain freshness. It will also prevent odour transfer. Fruit and vegetables need not be wrapped provided they are stored in the vegetable bins of the refrigerator.
- Make sure that strong smelling foods are wrapped or covered and stored away from foods such as butter, milk and cream which can be easily tainted by strong odours.
- Refrigerate fresh, perishable foods as soon as possible after purchase. If left at room temperature for any length of time the rate of deterioration will be accelerated.
- Avoid placing food directly in front of air outlets, as it may freeze and cold air needs to circulate to maintain safe food storage.
- Do not open the refrigerator door unnecessarily.
- Cool hot foods down before placing them in the refrigerator. This should be done quickly. It can be aided by placing the container of food in a bowl of ice and water; renew the ice as necessary. (Note also that hot containers may damage shelves and walls of the refrigerator).
- Store raw and cooked food in separate containers or packaging to prevent cross contamination.
- Keep the refrigerator clean. Wipe the inside walls and shelves frequently (refer to section ‘Cleaning and caring for your refrigerator’) and place only clean containers in the refrigerator.
- Keep a close check on the quality of food in your refrigerator. Discard any food that shows signs of spoilage. Pay particular attention to meat, fish and poultry, as these foods are highly perishable. Use food within the recommended storage times.

Items stored in your refrigerator

- Dairy items such as butter and cheeses should be stored in the covered door shelf to minimize any transfer of odor or odor absorption from other foods.
- Eggs should be stored in their carton to avoid absorption of strong odors through their porous shell structure.

Items stored in your freezer

- Do not store carbonated drinks in the freezer as this could lead to freezing liquid and the likelihood of bottle/can explosion.
- Ensure air is removed from packaging to avoid large formation of ice crystals and to prevent freezer burn.
- Maintain freshness and quality by defrosting frozen food in the refrigerator
- Ensure partially or fully defrosted foods are never re-frozen—always cook immediately.

TROUBLESHOOTING

If there is a problem with your appliance, check the following points before contacting your local Fisher & Paykel trained and supported service technician or the Customer Care Centre.

Product parts and accessories can be purchased through Fisher & Paykel Customer Care Centre or online at fisherpaykel.com (this service is available to selected markets only).

All models

PROBLEM	POSSIBLE CAUSES	WHAT TO DO
Appliance does not operate	No electricity at power outlet.	Check that the plug is correctly connected and power switched on.
		Check another appliance at the same outlet.
		Check house fuse.
Motor operates for long periods	Hot weather.	Minimise door openings to allow temperature to stabilise.
	Frequent door openings.	
	Large amount of food recently added.	Refer to section 'Temperature control' for your specific model.
	Temperature control set too low.	
Doors not sealing properly.	Check that cabinet is level and gasket seals are clean.	
Storage compartments too warm	Temperature setting not correct.	Refer to section 'Temperature control' for your specific model.
	Frequent door openings.	Minimise door openings to allow temperature to stabilise.
	Large amount of food recently added.	
Food freezing in the refrigerator	Temperature setting not correct.	Refer to section 'Temperature control' for your specific model.
	Food placed directly in front of air outlets.	Move chill sensitive foods away from the centre back of the shelves.
Unfamiliar noises	Cabinet not stable or level.	Refer to section 'Installation instructions' for your specific model. For ActiveSmart™ models refer to page 16.
	Freezer is defrosting.	
Exterior of cabinet is warm	This is normal.	Nothing.

TROUBLESHOOTING

All models

PROBLEM	POSSIBLE CAUSES	WHAT TO DO
Condensation on outside of refrigerator/freezer	Not unusual during periods of high humidity.	Wipe dry.
Door handles out of alignment	With time and usage, movement may occur.	Refer to section 'Installation instructions' for your specific model.
Appliance operating inefficiently	Accumulation of dust on or behind the rear compartment cover.	Refer to the section 'Cleaning care instructions' for your specific model. If problem persists please contact Customer Care.
Ice buildup inside freezer compartment	Freezer door not closing tightly.	Move items in freezer so door can close tightly. Check and clean door gasket seal.
Taste of odour in ice cubes	Transfer of odour/taste from strong smelling foods.	Wrap or cover strong smelling foods.

TROUBLESHOOTING

ActiveSmart™ models only

PROBLEM	POSSIBLE CAUSES	WHAT TO DO
Light not working	Light not functioning.	For ActiveSmart™ models, the light cannot be serviced by the user. Contact your Fisher & Paykel trained and supported service technician.
Light and display not working (ActiveSmart™ models)	Product in 'Sabbath mode'.	Press and hold  down for 10 seconds.
Unfamiliar noises	Cabinet not stable or level.	Refer to section 'ActiveSmart™ user warnings and sounds'.
	Freezer is defrosting.	
Condensation inside fresh food compartment	Frequent or long door openings.	Minimise door openings.
	Door gasket leaking.	Check that gasket is sitting flat and sealing tightly.
	Not unusual during periods of high humidity.	Wipe dry.
Tray/bin does not slide in and out evenly	Packaging trapped.	Check to ensure no food or packaging is trapped behind the tray/bin.
	Runners not extending fully.	Holding onto sides of tray/bin, extend the runners fully by using a firm pull – this will reset the runner.

TROUBLESHOOTING

Vertical refrigerator models only

PROBLEM	POSSIBLE CAUSES	WHAT TO DO
Light not working	Light not functioning.	For Vertical refrigerator models – the light bulb has blown, replace bulb.
Water in the vegetable bins	Condensation is formed by the water produced by fruit and vegetables.	<p>A small amount of condensation is beneficial for fruit and vegetable storage.</p> <p>Wipe out water with a cloth.</p> <p>Set humidity slide to low humidity setting </p>
Tray/bin does not slide in and out evenly	<p>Packaging trapped.</p> <hr/> <p>Runners not extending fully.</p>	<p>Check to ensure no food or packaging is trapped behind the tray/bin.</p> <hr/> <p>Holding onto sides of tray/bin, extend the runners fully by using a firm pull – this will reset the runner.</p>

SERVICE & WARRANTY

For details of your manufacturer's warranty and contacts for servicing, refer to your separate service and warranty book provided with your appliance.

This product has been designed for use in a normal domestic (residential environment). This product is not designed for any commercial use. Any commercial use by the customer will affect this products manufacturer's warranty.

Complete and keep for safe reference:

Model _____

Serial No. _____

Purchase Date _____

Purchaser _____

Dealer _____

Suburb _____

Town _____

Country _____

FISHERPAYKEL.COM

© Fisher & Paykel Appliances 2018. All rights reserved.

The product specifications in this booklet apply to the specific products and models described at the date of issue. Under our policy of continuous product improvement, these specifications may change at any time. You should therefore check with your Dealer to ensure this booklet correctly describes the product currently available.

NZ AU HK SG

851491A 12.18