

17.1 cu ft Series 5 Refrigerator Freezer, Ice & Water

Series 5 | Contemporary

Stainless Steel | Left hinge



This stylish left hinge refrigerator has a large capacity and comes in timeless stainless steel.

- Bottom freezer drawer
- ActiveSmart™ helps keep food fresher for longer
- Brushed metal handles

DIMENSIONS

Height	67 3/4 "
Width	31 1/8 "
Depth	27 3/8 "

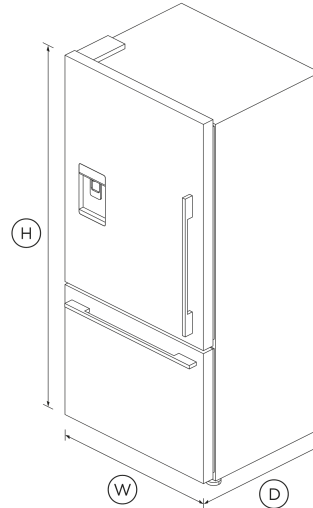

SPECIFICATIONS

Accessories (sold separately)

Joiner Kit	819264
Surround Kit (Joined left/right pair)	Part number 24476
Surround Kit (Right Hand)	Part number 24475

Capacity

Total gross capacity	17.1 cu ft
Volume freezer	4.8 cu ft

Volume refrigerator	12.3 cu ft
---------------------	------------

Consumption

Energy rating	Energy star
Energy usage	535kWh/year
In-use energy carbon emissions estimate	66.0kgCO2e/year

Features

Adjustable door shelves	14
Adjustable glass shelves	4
Covered door shelves	2
Door alarm	•
Fruit and vegetable bins	2
LED lighting	•
Smart appliance	•
SmartTouch control panel	•
Stackable bottle holders	2
Ultra slim water dispenser	•
Water Filter	Model number 836848

Freezer Features

Automatic ice maker	•
Bottle chill	•
Fast freeze	•
Ice bin and scoop	•
Ice Boost	•
Large plastic bins	•

Performance

- ActiveSmart™ Foodcare •
- Adaptive defrost •
- Frost free freezer •
- Humidity control system •
- Sabbath mode •

The product dimensions and specifications in this page apply to the specific product and model. Under our policy of continuous improvement, these dimensions and specifications may change at any time. You should therefore check with Fisher & Paykel's Customer Care Centre to ensure this page correctly describes the model currently available. © Fisher & Paykel Appliances Ltd 2020

All appliances use energy, and energy usage typically generates carbon emissions. **Fisher & Paykel Appliances' In-use Energy Carbon Emissions Estimate** indicates carbon emissions from a product's in-use energy. This is calculated either annually or per cycle, using the product's market-specific energy label energy consumption data multiplied by the carbon emissions factor for energy in your country or region.

Power requirements

Rated current	10 A
Supply frequency	60 Hz
Supply voltage	115 V

Other product downloads available at fisherpaykel.com

- [↓](#) 2D-DWG Freestanding Refrigerator Freezer
- [↓](#) 2D-DXF Freestanding Refrigerator Freezer
- [↓](#) Data Sheet Freestanding Refrigerator Freezer
- [↓](#) Energy Label
- [↓](#) Service & Warranty
- [↓](#) Water Filter Replacement Instructions - Parts 847200 and 847201 - EN
- [↓](#) Installation Guide - Quick Reference EN
- [↓](#) Water Filter Replacement Instructions - Parts 862285 and 862288 - EN
- [↓](#) Installation Guide Refrigerator Freezer EN
- [↓](#) Installation Guide - Joiner Kit EN
- [↓](#) Water Filter Replacement Instructions - Parts 847200 and 847201 - FR
- [↓](#) Water Filter Replacement Instructions - Parts 862285 and 862288 - FR
- [↓](#) Installation Guide - Joiner Kit FR
- [↓](#) User Guide Refrigerator Freezer EN
- [↓](#) User Guide Refrigerator Freezer FR

Our In-use Energy Carbon Emissions Estimate is designed to assist customers in making informed purchasing decisions when comparing different Fisher & Paykel products. For example, a heat pump dryer typically has a lower In-use Energy Carbon Emissions Estimate than a vented dryer.



A PEACE OF MIND SALE
24 Hours 7 Days a Week Customer Support
 T 1.888.936.7872 Wwww.fisherpaykel.com

Product dimensions

Depth	27 3/8 "
Height	67 3/4 "
Minimum air clearance at rear	1 3/16 "
Minimum air clearance each side	1 3/16 "
Width	31 1/8 "

Where applicable:

Warranty

Parts and labor	2 years
Sealed system parts & labor	additional 3 years

SKU 26294