

FISHER & PAYKEL

COMBINATION STEAM OVEN

CONTEMPORARY

OS30NDTDX1, OS30NDTDB1

PROFESSIONAL

OS30NPTX1

USER GUIDE

US CA

CONTENTS

Safety and warnings	4
First use	9
Menu	11
Setting a function	12
Filling the water tank	15
Conditioning the oven	16
Setting the water hardness	17
Wi-Fi connection and remote mode	18
Cooking options	20
Wired temperature sensor	21
Wireless temperature sensor	22
Sabbath Mode	23
Oven shelves	24
Care and cleaning	25
Replacing oven lights	29
Removing the oven door	31
Refitting the oven door	32
Dry cycle	35
Troubleshooting	36
Fault codes	39

Registration

To register your product visit our website: fisherpaykel.com/register

⚠ WARNING!



Electric Shock Hazard

Failure to follow this advice may result in electrical shock or death.

- Turn the oven off at the wall before replacing the oven lamp.
- Before carrying out any work on the electrical section of the appliance, it must be disconnected from the mains electricity supply.
- Connection to a good earth wiring system is absolutely essential and mandatory.
- Alterations to the domestic wiring system must only be made by a qualified electrician.

⚠ WARNING!



Fire Hazard

Failure to follow this advice may result in overheating, burning, and injury.

- Carefully follow the instructions for starting a self-clean cycle.
- Do not place aluminum foil, dishes, trays, water or ice on the oven floor during cooking, this will irreversibly damage the enamel. Lining the oven with aluminum foil may cause fire.
- Never use your appliance for warming or heating the room. Persons could be burned or injured or a fire could start.
- Flammable materials should not be stored in an oven or near its surface.
- Do not use adapters, reducers, or branching devices to connect this appliance to the mains power supply.

⚠ WARNING!



Cut Hazard

Failure to use caution could result in injury.

- Take care: some edges are sharp.

⚠ WARNING!



Hot Surface Hazard

Failure to follow this advice could result in burns and scalds.

- To avoid burns and scalds, keep children away from this appliance.
- Surfaces of the appliance may become hot enough to cause burns. Examples include the oven vent, the surface near the oven vent, and the oven door.
- Do not touch heating elements or interior surfaces of the oven. Heating elements may be hot, even when they are dark in colour.
- Use protection when handling hot surfaces, such as oven shelves or dishes, or when using steam functions.
- Be careful when opening the oven door as hot air and steam can be emitted, especially when using steam functions. Allow hot air and steam to dissipate before removing or replacing food.
- During and after use, do not touch or let clothing or other flammable materials contact heating elements or interior surfaces of the oven until they have had sufficient time to cool.

READ AND SAVE THIS GUIDE

SAFETY AND WARNINGS

WARNING!

To reduce the risk of fire, electrical shock, injury to persons or damage when using the oven, follow the important safety instructions listed below. Read all the instructions before installing or using the oven. Use the oven only for its intended purpose as described in these instructions.

Installation

- Ensure your appliance is properly installed and earthed by a qualified technician.
- Ensure this oven is connected to a circuit which incorporates an isolating switch providing full disconnection from the power supply.
- Do not install or operate the appliance if it is damaged or not working properly. If you receive a damaged product, contact your dealer or installer immediately.
- Please make this information available to the person installing the appliance—doing so could reduce your installation costs.
- This appliance must be installed and connected to the mains power supply only by a suitably qualified person according to these installation instructions and in compliance with any applicable local building and electricity regulations. Failure to install the appliance correctly could invalidate any warranty or liability claims.
- If the power supply cable is damaged, it must be replaced by the manufacturer, its service agent or similarly qualified person in order to avoid a hazard.
- Isolating switch: make sure this oven is connected to a circuit which incorporates an isolating switch providing full disconnection from the power supply in accordance with the wiring rules.
- The oven must be earthed.
- Do not use adaptors, reducers or branching devices to connect the oven to the mains electricity supply, as they can cause overheating and burning.
- The appliance must not be installed behind a decorative door in order to avoid overheating.
- Please take extra care not to damage the lower trim of the oven during installation. The trim is important for correct air circulation and allows the door to open and close without obstruction. The manufacturer does not accept any responsibility for damage resulting from incorrect installation.

Servicing

- Do not repair or replace any part of the appliance unless specifically recommended in the user guide. All other servicing should be undertaken by a Fisher & Paykel trained and supported service technician or qualified person.

Fire Hazard

- Do not use water on grease fires. Smother the fire or flame or use a dry chemical or foam type extinguisher.
- Use only dry oven mitts or potholders. Moist or damp potholders on hot surfaces could result in burns from steam. Do not let potholders touch hot areas or heating elements. Do not use a towel or a bulky cloth for a potholder. It could catch fire.
- Do not heat unopened food containers. They can build up pressure that may cause the container to burst and result in injury.

Food Safety

- Leave food in the oven for as short a time as possible before and after cooking. This is to avoid contamination by organisms which may cause food poisoning. Take particular care during warm weather.

SAFETY AND WARNINGS

General Use

- This product has been designed for use in a domestic (residential) environment. This product is not designed for any commercial use. Any commercial use by the customer will affect this product's manufacturer's warranty.
- Household appliances are not intended to be played with by children.
- Children should not be left alone or unattended in the area where the appliance is in use. They should never be allowed to sit or stand on any part of the appliance.
- Children of less than 8 years old must be kept away from the appliance unless continuously supervised.
- Cleaning and user maintenance shall not be carried out by children without supervision.
- Do not store things children might want above the oven. Children could be burned or injured while climbing on the oven to retrieve items.
- Do not place heavy objects on the oven door.
- Always keep oven vents unobstructed. Do not wear loose fitting or hanging garments when using the appliance. They could ignite or melt if they touch an element or hot surface and you could be burned.
- Caution: Hot air can blow from the vent at the top of the oven as part of the oven's cooling system.
- Always position shelves in the desired location while the oven is cool (before preheating). If a shelf must be removed while the oven is hot, do not let the oven mitts or potholder contact hot heating elements in the oven or the base of the oven.
- Use only bakeware approved for ovens. Follow the bakeware manufacturer's guidance.
- Always place oven racks in desired location while oven is cool. If rack must be moved while oven is hot, do not let potholder contact hot heating element.
- Do not touch heating elements or interior surfaces of your oven. Heating elements and interior surfaces may be hot even though they are dark in color and could cause burns. The oven door, vent openings and surfaces near these openings may also become hot.
- This appliance is configurable to allow remote operation at any time. Do not store flammable materials or temperature sensitive items inside, on top or near the appliance.
- Neither the food probe or aluminum foil must come in contact with the oven elements.
- Only use the temperature probe recommended for this oven.
- The appliance must not be installed behind a decorative door in order to avoid overheating.
- **WARNING:** Accessible parts may become hot during use. Young children should be kept away.

Cleaning

- Do not clean the oven seal or use any oven-cleaning products on it. It is essential for a good seal, which ensures that the oven operates efficiently. Care should be taken not to rub, damage, move or remove the oven seal.
- Do not use oven cleaners, harsh/abrasive cleaning agents, waxes, or polishes. No commercial oven cleaner, oven liner, or protective coating of any kind should be used in or around any part of the oven.
- Do not use harsh/abrasive cleaners, scourers or sharp metal scrapers to clean the oven door glass since they scratch the surface, which may result in the glass shattering.
- Clean only the parts listed in this manual.
- Do not use a steam cleaner to clean any part of the oven.
- The door gasket is essential for a good seal. Care should be taken not to rub, damage or move the gasket.

SAFETY AND WARNINGS

IMPORTANT!

This device complies with part 15 of the FCC Rules. Operation is subject to the following conditions:

- This device may not cause harmful interference.
- This device must accept any interference received, including interference that may cause undesired operation.
- Do not change or modify the wireless communication device in any way. Changes or modifications not expressly approved by Fisher & Paykel could void the user's authority to operate the equipment.

WARNING: The incorporated Wi-Fi module in this appliance is to operate only from channel 1 to channel 11 as per FCC rules.

This device contains licence-exempt transmitter /receiver that comply with Innovation, Science and Economic Development Canada's licence-exempt RSS(s). Operation is subject to the following two conditions:

- This device may not cause interference.
- This device must accept any interference, including interference that may cause undesired operation of the device.

FIRST USE



Features and accessories

- ① Oven controls
- ② Water tank
- ③ Flat wire shelf
- ④ Side racks
- ⑤ Wired temperature sensor
- ⑥ Broil rack
- ⑦ Sliding shelves
- ⑧ Steam dish (large)*
- ⑨ Perforated steam dish (small)*
- ⑩ Perforated steam dish (large)*
- ⑪ Broil pan
- ⑫ Descale solution x 2 (not shown)

Not all accessories are provided with all models. To purchase additional accessories go to www.fisherpaykel.com

* Not intended for use over 210°F

FIRST USE

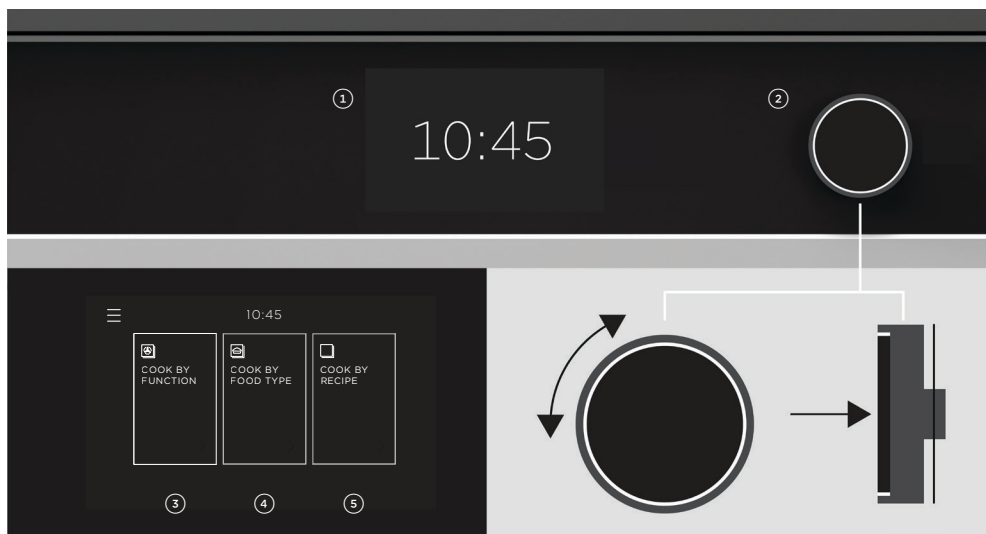

① Touchscreen display	Use to navigate cooking functions, features and settings.
② Control dial*	<ul style="list-style-type: none">• Turn the dial to scroll.• Press to select.• Press and hold to go back.
③ Cook by Function	Choose a function best suited to your cooking requirements.
④ Cook by Food Type	Guided cooking to help you get optimal results.
⑤ Cook by Recipe**	A collection of recipes designed specifically for this style of oven.
⑥ Menu	Press to access additional features and settings.

*Some models only.

**Recipes available in some languages only.

MENU

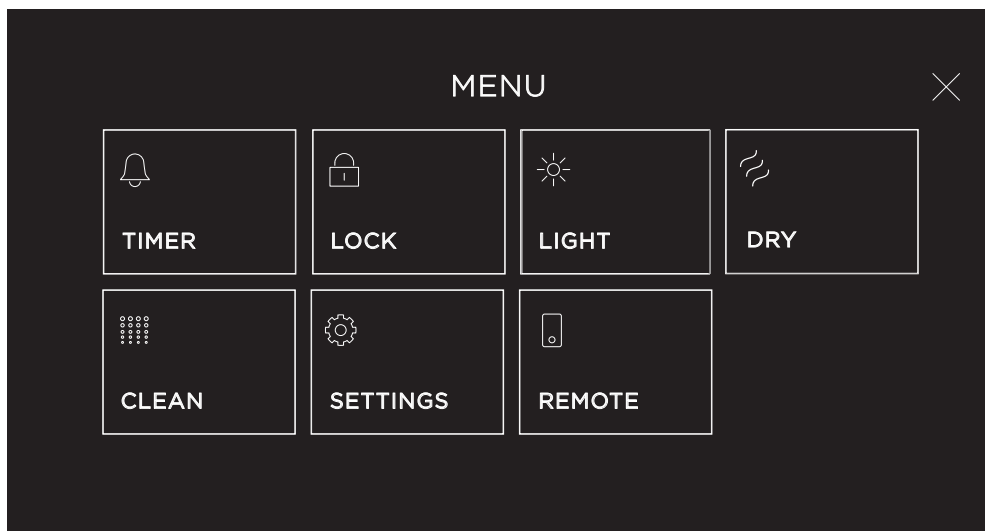

TIMER



Use the timer to keep track of cooking times. You can use it at any time, even if you are not using the oven.

The timer does not turn the oven off. Refer to 'Cooking options' for the automatic cooking options.

LOCK



Lock the controls to prevent accidental use. When locked, the controls will be unresponsive and the appliance will not turn on. Press and hold the screen anywhere to unlock.

LIGHT



Turn the oven lights **ON/OFF**.

DRY



Run a dry cycle to help remove any moisture from your oven.

CLEAN



Set a self clean cycle to clean the inside of the oven. Refer to 'Descaling' or 'Steam clean' for full instructions.

SETTINGS



Adjust the settings to suit your preferences or set up a Wi-Fi connection.

REMOTE



Connect appliance to your mobile device to operate it remotely via the app.

SETTING A FUNCTION

Before you begin

- Ensure all cable ties and packaging have been removed.
- Set the time. To change the time at any point go to **SETTINGS** and select **CLOCK: SET TIME**.
- Condition your oven according to the instructions under 'Conditioning the oven'.
- Set the water hardness according to the instructions under 'Water hardness.'
- Connect your oven to Wi-Fi to operate remotely using the app. For more information refer to 'Wi-Fi Connection & Remote mode'.

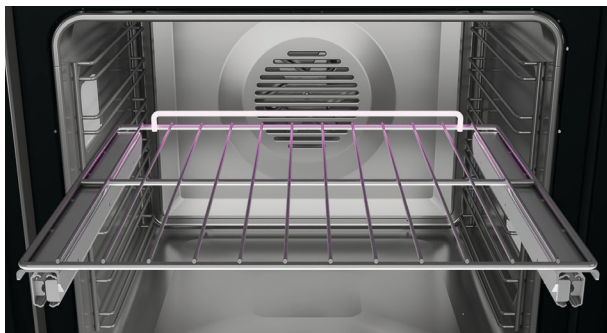

1. Position the shelves at the required height. Refer to 'Oven shelves' for guidance.



2. Select a cooking mode.

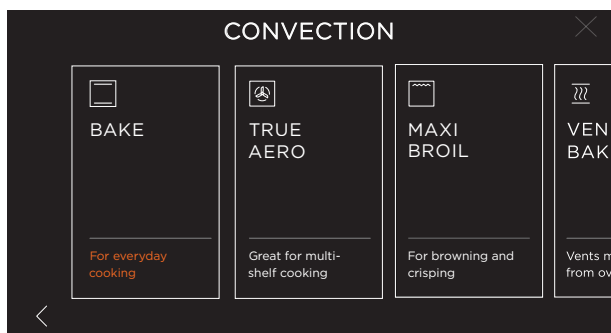

3. Select a function.
For more information on each function, select the description below the function name.

SETTING A FUNCTION

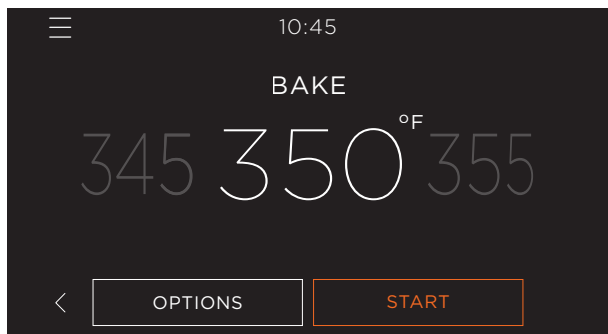

4. Adjust the temperature if needed, then press **START**.

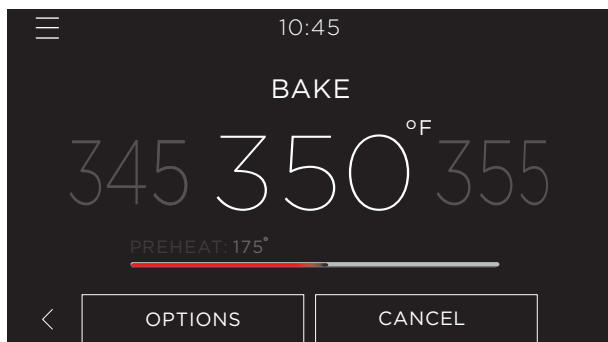

Preheating

A progress bar will show on the screen while the oven is heating. To prevent burning, wait until the oven has reached temperature before placing food inside.

Some functions do not need to preheat and will not show a progress bar. Place food in the oven when ready to start cooking.

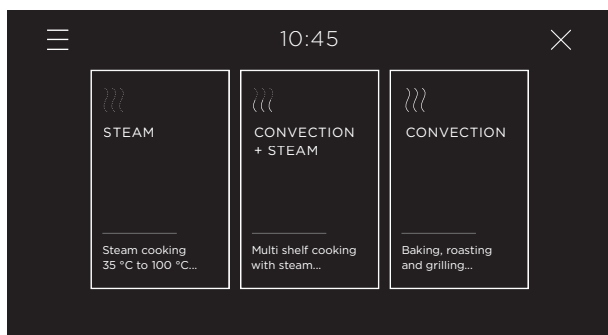

Using steam functions

1. Select **COOK BY FUNCTION**, then select the desired steam function.

SETTING A FUNCTION



2. Set the desired temperature, and press **START**.

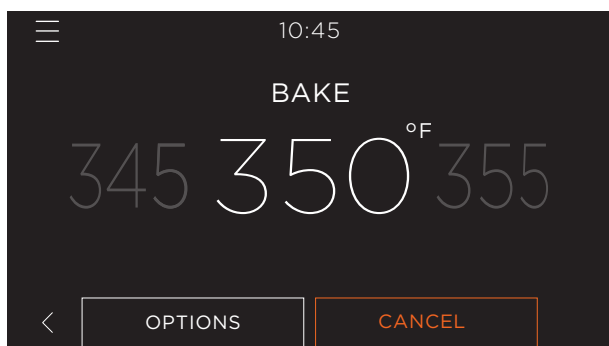

Turning the oven off

When you have finished cooking, press **CANCEL** to turn the oven off.

Drying the oven

After running a steam function, there may be some moisture left in the oven. Wait for the oven to cool, then wipe out the base of the cavity with a sponge or soft cloth. We recommend running a dry cycle after you have wiped out the base of the cavity to help remove any remaining moisture. Refer to 'Dry cycle' for more information.

Maximum steam cooking times

The below maximum cooking times apply when using steam functions. We recommend staying within these cooking times to avoid a build-up of condensation inside the oven.

TEMPERATURE (F°)	MAX COOKING TIME (MINS)
210	120
195	120
175	120
160	280
140	320
120	360

FILLING THE WATER TANK

Before using any steam functions, you'll need to fill the water tank. For best results, we recommend filling the tank with fresh water before you cook.



1. Open the oven door and pull the water tank out of its compartment.



2. Fill with fresh water, taking care not to fill past the MAX FILL line.



3. Refit the tank in the compartment.

CONDITIONING THE OVEN

We recommend conditioning your oven for 1 hour before initial use to eliminate any manufacturing residue. A small amount of smoke may be present. Ensure kitchen is well ventilated.

After conditioning

- Wait for the oven to cool completely.
- Wipe oven with a damp cloth and mild detergent.
- Dry with a clean, lint-free cloth.

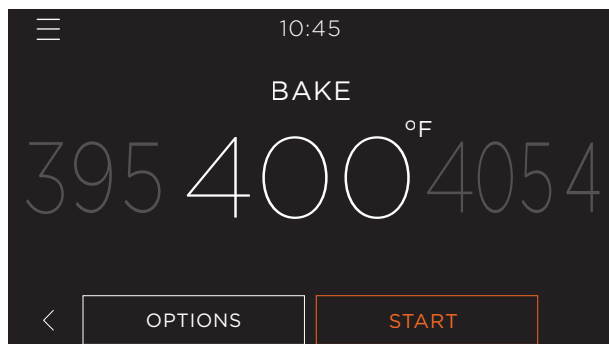

1. Set the oven to **BAKE** at 400°F and heat for 30 minutes. Press **START** to begin.

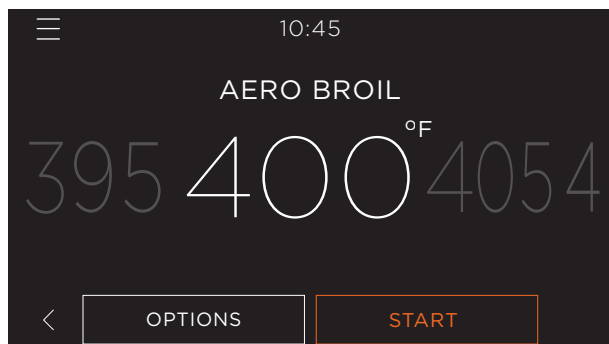

2. After 30 minutes, change the function to **AERO BROIL** and heat for 5 minutes.

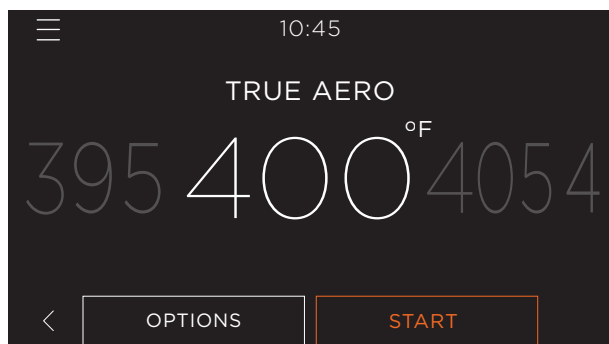

3. After 5 minutes, change to **TRUE AERO** and heat for a further 20 minutes.

SETTING THE WATER HARDNESS

Set the water hardness level before using steam functions for the first time. Contact your local water supplier if you are unsure of your water hardness level.

We do not recommend using this product with water hardness above 450ppm.

WATER HARDNESS (PPM)	LEVEL
0 - 100	ZERO
100 - 250	ONE
250 - 350	TWO
350 - 450	THREE

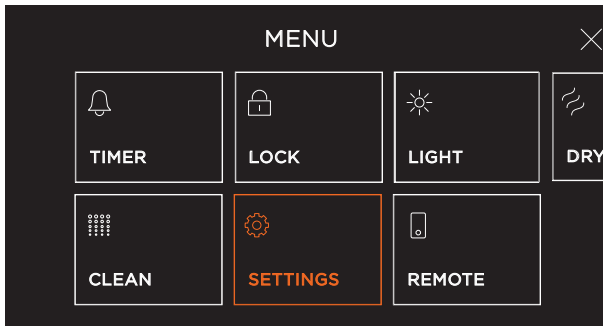

Setting water hardness level

1. From the menu, select **SETTINGS**.



2. Select **DESCALE: WATER HARDNESS**.



3. Select relevant water hardness level then press **CONFIRM**.

WI-FI CONNECTION AND REMOTE MODE

Your appliance may be connected to your home wireless network and operated remotely using the app. Connect your appliance to ensure it stays up to date with the latest software and features.

Getting started

- Ensure your home Wi-Fi network and Bluetooth on your mobile device are turned on. You will be given step-by-step guidance on both your appliance and mobile device.
- It may take up to 10 minutes to connect your appliance.



On your mobile device:

- ① Download the app. Scan the QR code or go to www.fisherpaykel.com/connect
- ② Register and create an account.
- ③ Add your appliance and set up the Wi-Fi connection.

Connecting to your home Wi-Fi



1. Go to the menu.

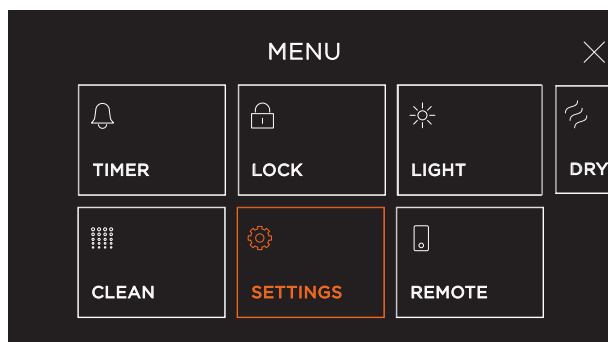

2. Select **SETTINGS**.

WI-FI CONNECTION AND REMOTE MODE

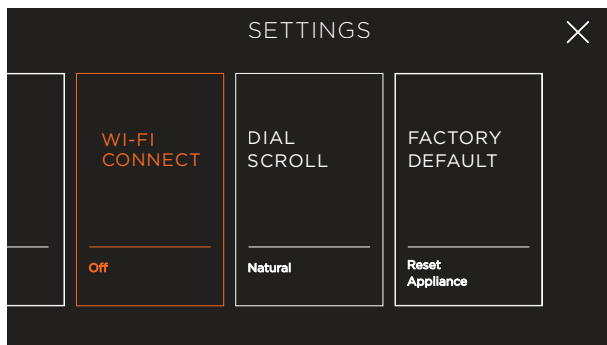

3. Select **WI-FI CONNECT** and follow the onscreen instructions.

Enabling Remote Mode

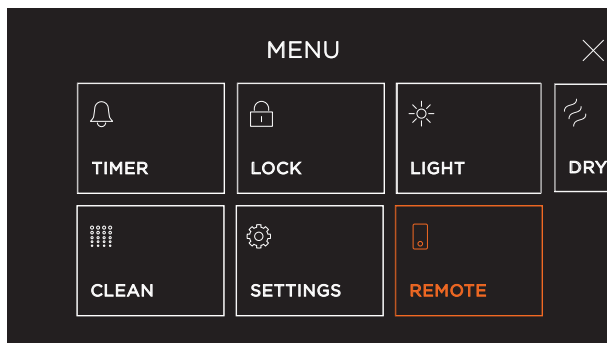

1. Go to the menu and select **REMOTE**.

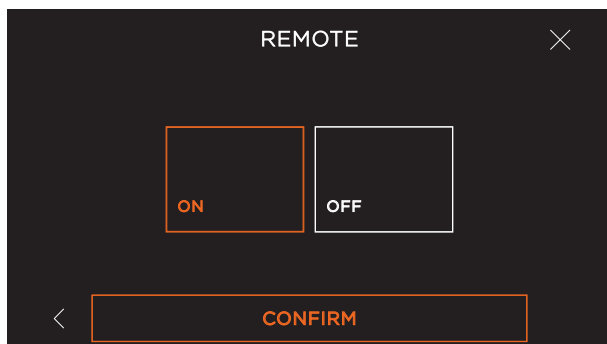

2. Select **ON**, then press **CONFIRM**.
Remote mode is now enabled.

COOKING OPTIONS

CHANGE FUNCTION	Quickly view and switch functions.
DELAYED COOK	Set the oven to turn on later, cook for a set length of time and turn off automatically.
AUTO OFF	Set the oven to turn off after a set length of time.
TEMPERATURE SENSOR	Use the sensor to monitor cooking and automatically turn the oven off when food is done.

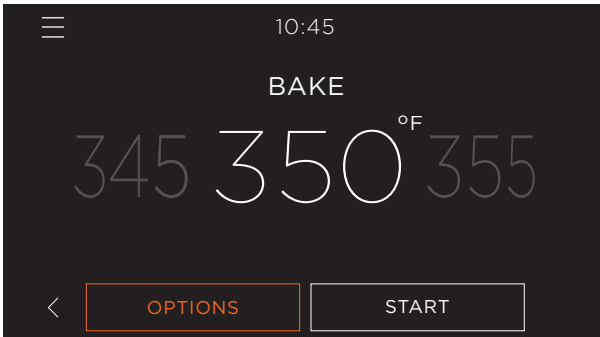

Accessing options

1. Select a function, then press **OPTIONS**.

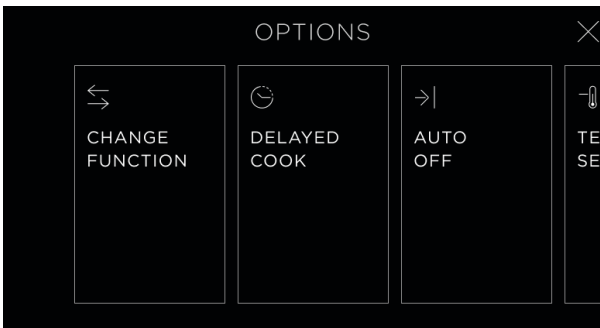

2. Select a cooking option and follow the onscreen instructions.

Food safety

- Leave food in the oven for as short a time as possible before and after cooking.
- For best results, ensure meat is fully defrosted before cooking. If cooking food from frozen, increase cook time by 50 per cent.

Rest meat after cooking to allow the internal temperature to continue to rise. High risk foods such as fish should reach a minimum internal temperature of 145-160°F and poultry and minced meat should reach 170-185°F.

Delayed cook

The broil element may come on while the oven is heating up. Position food on a lower shelf or cover to prevent burning as the oven heats up. When using **DELAYED COOK** we do not recommend using **MAXI BROIL**, **AERO BROIL**, **STEAM PROOF**, **STEAM DEFROST** or **AIR FRY**.

WIRED TEMPERATURE SENSOR

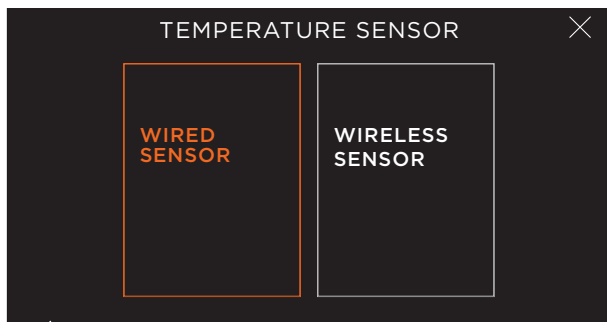

1. Select a cook function
Go to **OPTIONS** and select **TEMPERATURE SENSOR**, then select **WIRED SENSOR**.

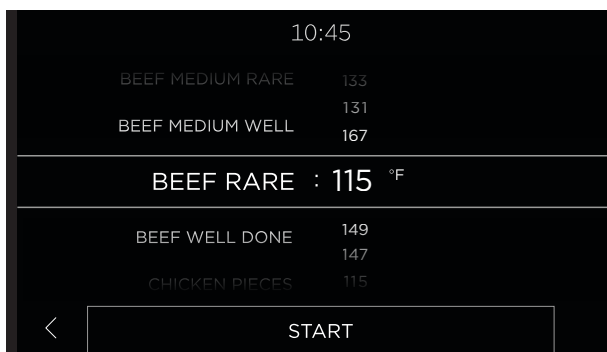

2. Select a food type and temperature then press **CONFIRM**.

Allow your oven time to preheat if necessary.

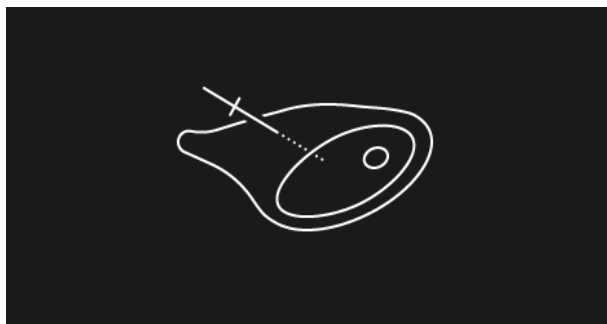

3. Insert the sensor into your food. Position the sensor in the thickest part of the dish, avoiding fat and bone in meat. Ensure the tip of the sensor doesn't protrude out the other side of food or touch cookware.



4. Place food in the oven and plug in the sensor. The sensor will click when it is in place. The socket is located inside the oven, on the left hand side.

WIRELESS TEMPERATURE SENSOR

Your oven may be connected to a compatible wireless temperature sensor. Compatible sensors are available to purchase at fisherpaykel.com/sensor.

Ensure your sensor is fully charged before use.

Do not use your wireless sensor to heat food above 210°F or place in an oven above 570°F.

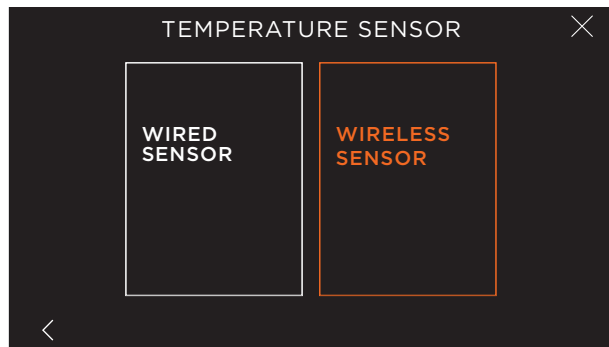

1. Select a cook function
Go to **OPTIONS** and select **TEMPERATURE SENSOR**, then select **WIRELESS SENSOR**.

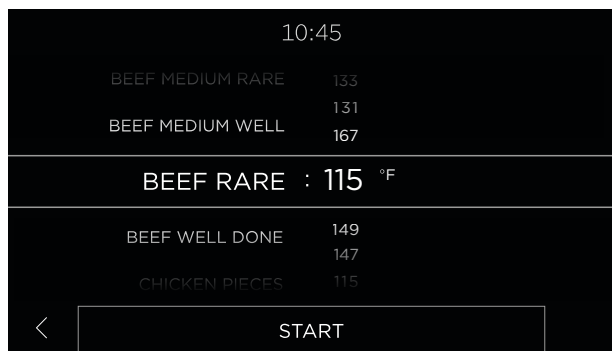

2. Select a food type and temperature then press **CONFIRM**.

Allow your oven time to preheat if necessary.

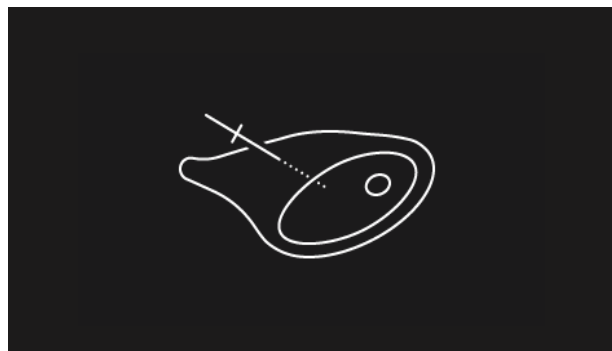

3. Insert the sensor into your food.

Position the sensor in the thickest part of the dish, avoiding fat and bone in meat.

Ensure the tip of the sensor doesn't protrude out the other side of food or touch cookware.

Ensure the sensor is inserted past the minimum line.

Place your food in the oven.

SABBATH MODE

For the Sabbath observant. Sabbath Mode sets your oven to heat continuously for as long as required. The display will be unresponsive and no tones or alerts will sound.

While your oven is in Sabbath Mode it can operate at the following temperature levels:

HEAT LEVEL	APPROX TEMP (°C)	APPROX TEMP (°F)	USE
Low	75 - 100	170 - 210	Keep hot food warm
Moderate	155 - 180	310 - 360	Reheat cooked food from cold
High	185 - 210	360 - 410	Cooking raw food

The oven may take some time to get to temperature. If you want to cook immediately after setting Sabbath Mode we recommend preheating the oven before setting. Opening the door frequently or for too long may result in heat loss.

During Sabbath Mode

- The display will be unresponsive.
- No tones or alerts will sound.
- Wi-Fi will be disconnected.
- The oven light will remain either on or off, depending on your preference.
- Lights, fans and display will not respond to the door opening.

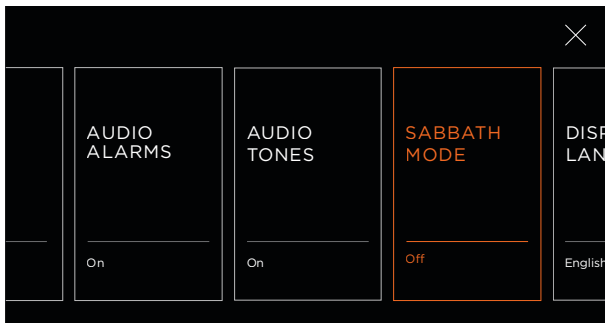

Setting Sabbath Mode

In the **SETTINGS** menu, select **SABBATH MODE** and follow the onscreen instructions.

The oven will heat for the set length of time and then turn off. At the end of the cook time, the oven will remain in Sabbath Mode until cancelled.

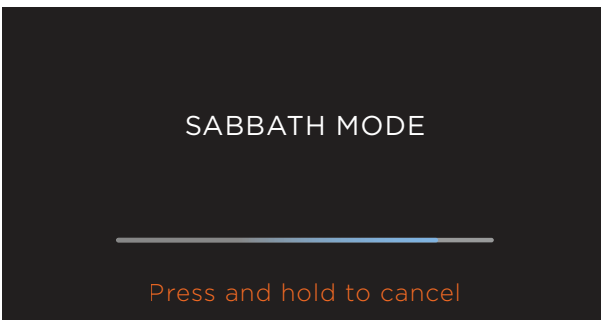

Cancelling Sabbath Mode

Press and hold anywhere on the screen to cancel.

OVEN SHELVES

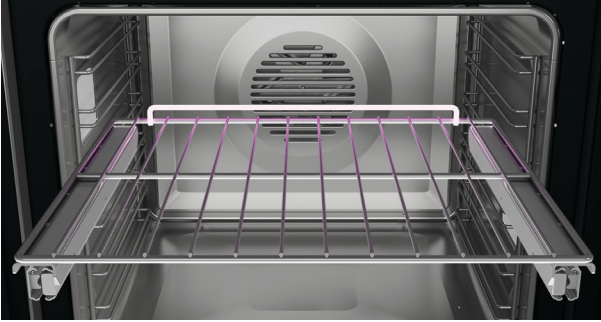

Place shelves in the oven at the required level before heating the oven. Ensure shelves are level and correctly positioned with the guard rail at the back.

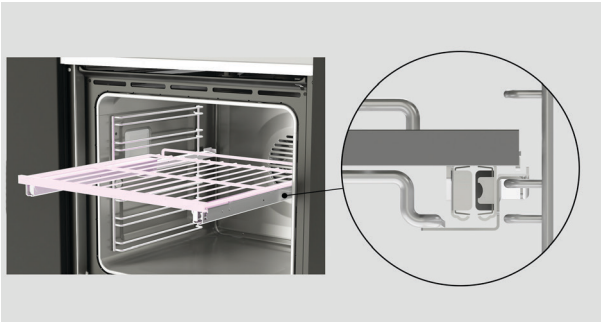

Sliding shelves

1. Grip shelves at the front, holding the wire shelf and frame together.

Place the shelf on top of the side racks, and push into the oven.

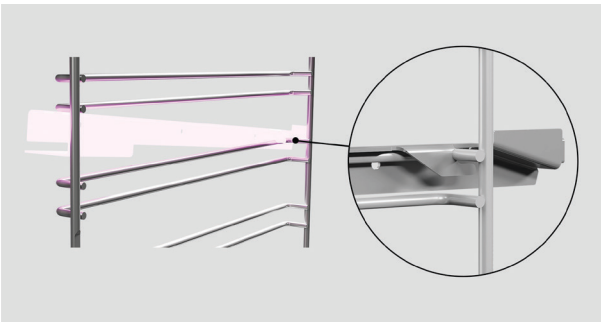

2. Ensure the rear tags are hooked over the side racks on both sides.

Place the shelf on top of the side racks, and push into the oven.

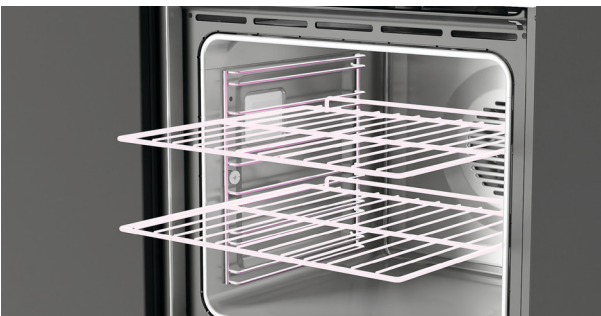

Wire shelves

Slide shelves into the cavity.

CARE AND CLEANING

Before cleaning, always allow the oven to cool to a safe temperature. Turn off the power supply before undertaking any manual cleaning or maintenance.

- Never use a steam cleaner.
- Never store flammable substances in the oven.
- Never use abrasive or harsh cleaners, cloths, scouring pads or steel wool. Some nylon scourers may also scratch. Check the label first.
- Never leave alkaline (salty spills) or acidic substances (such as lemon juice or vinegar) on the oven surfaces.
- Never use cleaning products with a chlorine or acidic base.

Oven door

Clean after each use with a soft cloth and a mixture of warm water and dishwashing liquid. For stubborn stains, try a mixture of baking soda and warm water with a non-abrasive scrubbing pad, then wipe dry with a soft, lint-free cloth.

Do not use the following cleaning products as they may cause damage:

- Plastic or stainless steel scouring pads
- Steel wool
- Metal scrapers
- Abrasive, solvent, oven/household cleaners.

Oven seal

Do not clean or remove this part. Take care not to rub, damage or move the oven seal.

Oven cavity

Light soiling

Clean the enamelled surfaces with a damp cloth and a solution of hot water and mild detergent or an ammonia-based cleaner, then wipe dry with a soft cloth.

After steam cooking, wait for the oven to cool, then wipe out any moisture from the bottom of the cavity. We recommend running a dry cycle to remove any remaining moisture.

Clean up any easy-to-reach spills, food or grease stains after each use to prevent them becoming 'baked on'. To help lift stubborn spills, run the steam clean cycle before wiping out the oven.

You can remove the oven door for greater cleaning access. See 'Removing the oven door'.

Control Panel

Take particular care when cleaning the control panel glass and screen. Only use a damp cloth with detergent.

Do not use any oven cleaners, harsh or abrasive cleaners, scouring pads, steel wool or sharp metal scrapers on the glass. These may scratch and damage the surface.

Dial

Clean with a solution of mild detergent and hot water, then wipe dry. Do not use stainless steel or oven cleaner on the dial, as doing so may damage its coating.

CARE AND CLEANING

Stainless steel strip/oven door handle

Clean with a solution of mild detergent and hot water, then wipe dry with a microfibre cloth. If necessary, use a suitable stainless steel cleaner and polish.

Always read the label to make sure that your stainless steel cleaner does not contain chlorine compounds as these are corrosive and may damage the appearance of your oven.

Always rub the stainless steel in the direction of the steel grain.

Racks, wire shelves, pans and trays

Clean with a mild detergent and hot water. Do not wash in the dishwasher.

Sliding shelf

Wipe clean with a damp cloth and mild detergent. Do not wipe off or wash away the white lubricating grease (visible when the shelf is extended).

Do not put in dishwasher, immerse in soapy water or use oven cleaner as these actions will prevent the slides from running smoothly.

Temperature sensor

Clean after every use. Use mild detergent and hot water, then wipe dry with a microfibre cloth.

Do not put in the dishwasher, immerse in soapy water or use oven cleaner on it.

SIDE RACKS

Removing the side racks

Remove the side racks to access the oven lights or to make cleaning easier.

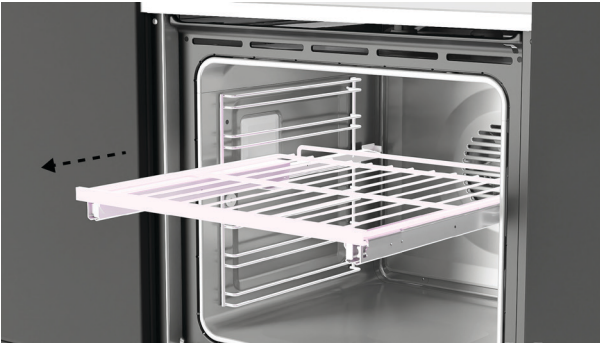

1. Remove all shelves.



2. Unscrew the nut holding the rack in position. Use a coin to loosen if required.

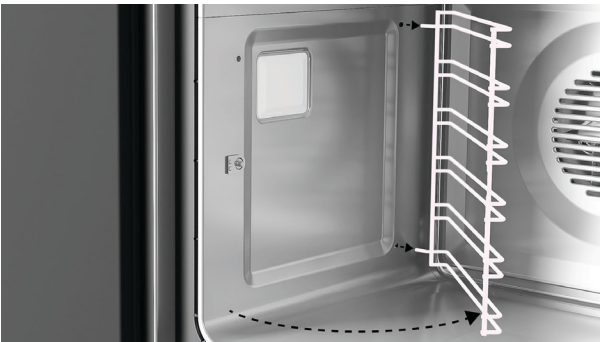

3. Pull the front of the rack clear of the screw and slide forward to remove.

SIDE RACKS

Refitting the side racks



1. Slide the prongs into the holes.
Ensure the rack sits flush against the side of the oven.



2. Align the tab with the screw and secure with the nut.
Use a coin to tighten if required.

REPLACING OVEN LIGHTS

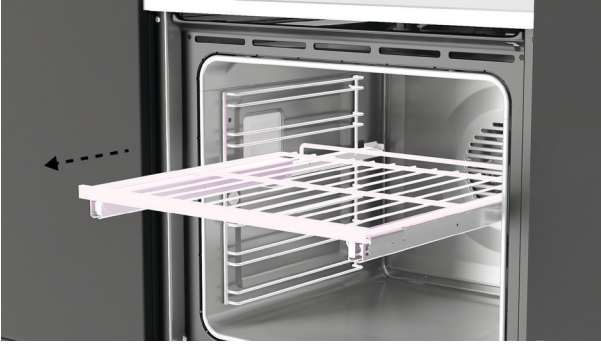

1. Remove all shelves and side racks.

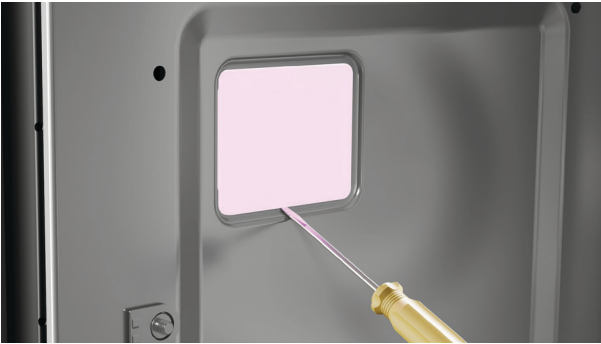

2. Use a flathead screw driver to carefully prise off the glass light bulb cover.

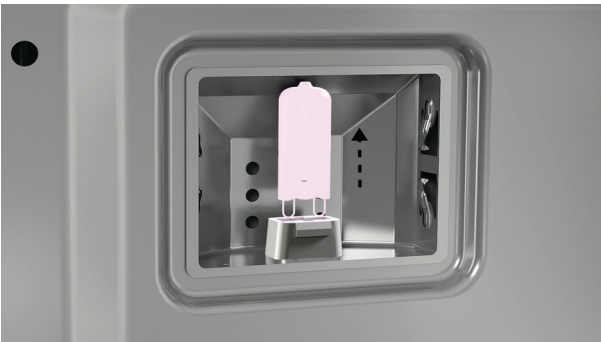

3. Remove the faulty bulb from the socket.

REPLACING OVEN LIGHTS

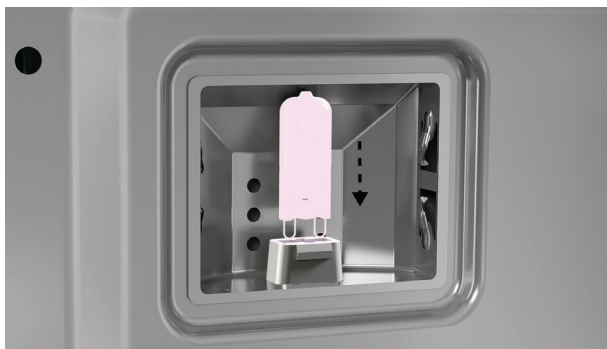

4. Insert the new bulb, using a soft cloth to hold it. Touching the bulb will reduce its lifespan.



5. Replace the cover.



Oven light specifications

G9 220 - 240V/25W halogen bulbs.

Replacement bulbs are available via www.fisherpaykel.com. Oven light replacement is not covered by your warranty.

REMOVING THE OVEN DOOR

The oven door can be removed for cleaning. Make sure the oven and all its parts have cooled down before removing the door.

The door is heavy, so take care while removing and refitting. Once the door is removed, place it on a soft, clean, flat surface.

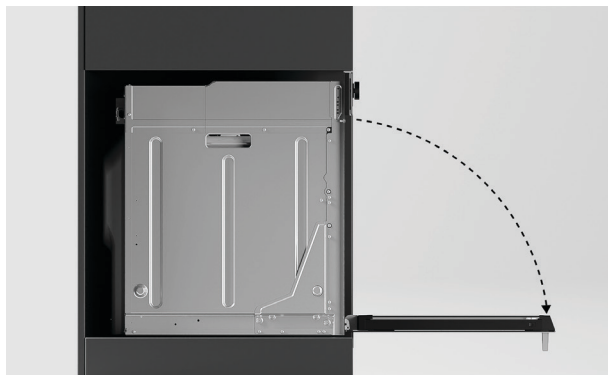

1. Open the door fully.

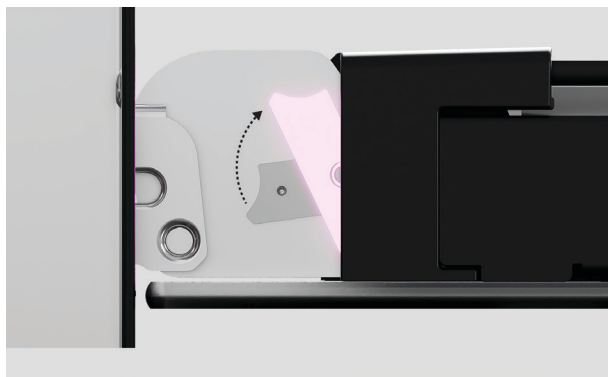

2. Locate the hinge locks on either side of the door.

Push the locks upwards to release.



3. Holding the door on both sides, partially close the door and carefully pull the door away from the hinges.

REFITTING THE OVEN DOOR

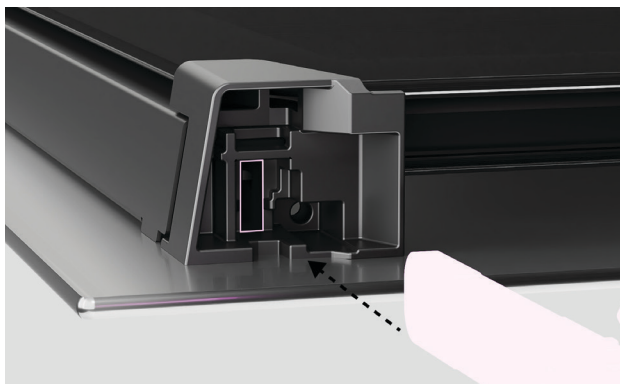

1. Holding the door on both sides, carefully lift door back onto the hinges.

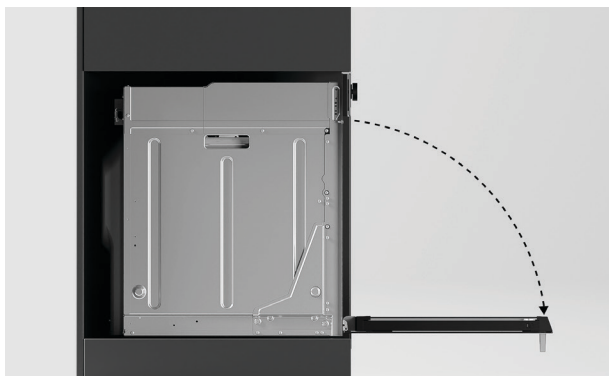

2. Open the door fully.



3. Push each locking lever down and lock into place. Ensure both hinges are fully locked before closing the door.

STEAM CLEAN

To help lift stubborn spills, run the steam clean cycle before wiping out the oven. For best results, the oven should be around room temperature before beginning.



1. Go to the menu.

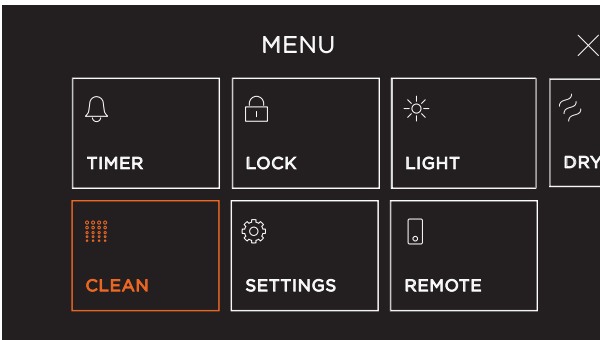

2. From the menu, select **CLEAN**.

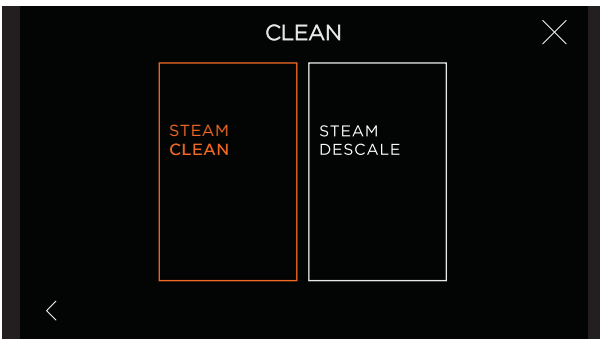

3. Select **SELF CLEAN**, and follow the onscreen instructions.

DESCALING

Descale your oven as soon as possible after the descale alert is shown. Failure to do this may cause the steam functions to become unusable.

Making descaling solution

Add 80 grams (1/3 cup) of citric acid powder to 1 liter of warm water. Take care when handling citric acid. Ensure you follow the manufacturer's instructions.



1. Go to the menu.

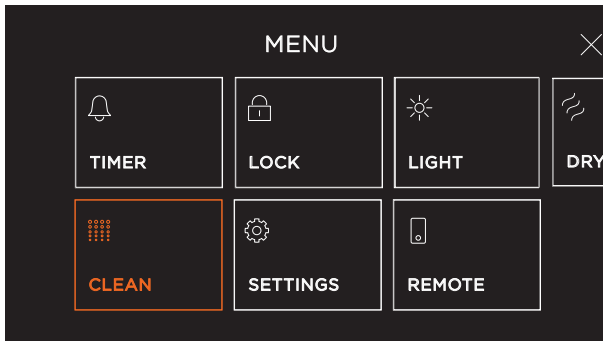

2. From the menu, select **CLEAN**.

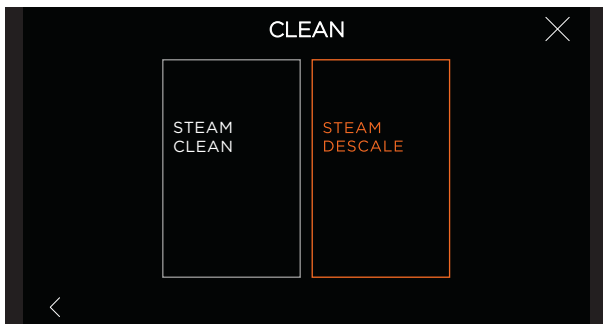

3. Select **STEAM DESCAL**, and follow the onscreen instructions.

After the Descal cycle is complete, wipe the base of the cavity to remove any excess moisture.

DRY CYCLE

After running a steam function, there may be some moisture left in the oven. You can run a dry cycle to help remove the remaining moisture:

- Remove any food from the oven before starting a dry cycle.
- If the dry cycle is not run regularly, excess moisture may build up in the cavity and cause damage. Damage caused by not running the dry cycle may void your warranty.



1. Wait for the oven to cool, then wipe out the base of the cavity with a sponge or soft cloth before starting a dry cycle.

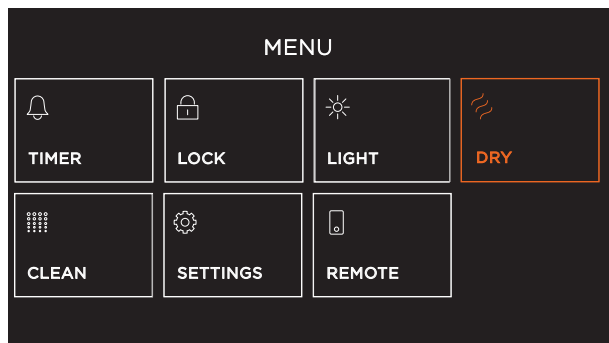

2. Select DRY.

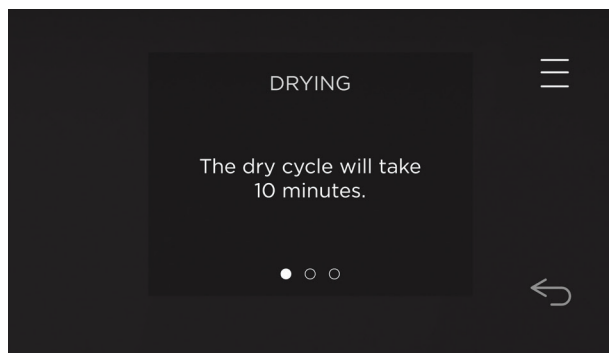

3. Follow the instructions on screen to start the dry cycle.

TROUBLESHOOTING

If there is a problem with your oven, please check the following points before contacting your local Fisher & Paykel trained and supported service technician or the Customer Care Centre.

General

PROBLEM	POSSIBLE CAUSES	WHAT TO DO
The oven does not work	No power	Check that the mains power supply (wall switch) is turned on, the fuse has not tripped and there is no power outage in your area.
The oven does not work but the screen is on.	The oven is in Demo Mode.	Call Customer Care.
The lights do not come on when I open the oven door.	The oven light bulb(s) have blown	Call Customer Care to arrange replacing the light bulb(s). See 'Care and cleaning' for instructions.
	The door is not correctly fitted.	See 'Care and cleaning' for instructions on fitting the door correctly.
	The oven light has been turned off.	Go to the menu in the top left corner of the screen and select LIGHT.
The oven controls are unresponsive.	The control panel is locked.	Touch and hold the screen to unlock.
The oven is not heating.	The door is not properly closed or it is opened too frequently during cooking.	The heating elements are disabled while the door is open. Make sure the door is properly closed and avoid opening it frequently during cooking.
A glass pane in the oven door has cracked, chipped, or shattered.	Incorrect cleaning or the edge of the glass hitting against something.	You must NOT use the oven. Contact a Fisher & Paykel trained and supported service technician or Customer Care
I can feel hot air blowing out of the vents after I have turned the oven off.	This is normal.	For safety reasons the cooling fans will continue to run even when you have turned the oven off. The fans will switch off automatically when the oven has cooled.
The oven fan comes on when I select a function that does not use a fan (eg bake or classic bake)	This is normal. The fan comes on while the oven is preheating. It may turn off when the oven has reached the set temperature.	Wait until the red heating bar on the screen disappears: the oven will then be ready to use.

TROUBLESHOOTING

PROBLEM	POSSIBLE CAUSES	WHAT TO DO
The oven has reached the set temperature but the temperature dial halo is still red*.	The oven is set to MAXI BROIL .	This is normal. The dial halo* will stay red whenever this function is in use as the broil element is always heating.
The oven sounds a tone when I try to set the temperature below a certain temperature.	This is normal: for food safety reasons, the oven functions have factory-set minimum temperature settings.	Select a different temperature or try a different function that is designed for low temperatures.
The temperature dial halo never turns white when I use MAXI BROIL *.	This is normal: the halo stays red to indicate that the broil element provides instant radiant heat.	
Control panel stops during travel/or doesn't travel when activated	<ul style="list-style-type: none"> • Moving control panel obstructed • Motor or gear failure 	<ul style="list-style-type: none"> • Check for any obstructions • Firmly push control panel with two hands to return to home position. If not movable by hand, contact a Fisher & Paykel trained and supported service technician or call Customer Care.
Cannot open control panel	Door is open	Ensure oven door is closed correctly.
'Tank level too low' displays on screen when water tank appears to have enough water	This is normal	Fill tank to maximum capacity.
Drip tray is overflowing	Drip tray is full	Open the door to access the drip tray. Empty tray either by sponge, or by lifting it from the product.
Fill tank button is unavailable	Water is being pumped from generator back into tank.	Button will become available once operation is complete.
Gurgling & spluttering noises from product	This is normal as the water boils.	
Steam functions are unavailable	<ul style="list-style-type: none"> • Descale required • Tank not installed correctly • Tank level too low 	Refer to screen for cause and follow onscreen guidance to correct.
Oven has moisture building up during cooking	This is normal. Many forms of cooking generate moisture.	The moisture can be dried out either using a cloth or using the dry cycle.
Burnt smell coming from cavity base	<ul style="list-style-type: none"> • Burnt descale solution • Burnt food residue 	<ul style="list-style-type: none"> • Clean oven • Ensure a solid tray is used below perforated pan to catch residue.

*Some models only.

TROUBLESHOOTING

PROBLEM	POSSIBLE CAUSES	WHAT TO DO
Oven is not detecting when water tank is empty	<ul style="list-style-type: none">• Hose may be trapped under the level sensor	<ul style="list-style-type: none">• Wait for oven to cool, then remove tank and adjust hose.
Steam generator is overheating	<ul style="list-style-type: none">• Hose may be trapped under the level sensor• Oven needs to be descaled.• Incorrect water hardness setting	<ul style="list-style-type: none">• Wait for oven to cool, then remove tank and adjust hose.• Run a descale cycle. See 'Descaling the oven.'• Change the water hardness setting. See 'Water Hardness.'
Tank is in but 'Tank not present' is displaying.	<ul style="list-style-type: none">• Tank not completely in place.	<ul style="list-style-type: none">• Push the tank completely into the space.
Oven is noisy when powered on/steam functions are running.	<ul style="list-style-type: none">• Steam function is calibrating/pump is going.	<ul style="list-style-type: none">• This is normal and will stop once calibrated/cycle has finished.
Water stain after dry cycle	<ul style="list-style-type: none">• Water hardness.	Ensure oven cavity is wiped clean regularly.

FAULT CODES

How do I know if there is a problem?

Your oven will beep and an alert will show in the display.

What to do

First try to fix the issue and clear the alert according to the instructions onscreen or the steps in the following table.

Do not turn the oven off at the wall unless it is completely cool. Turning off the power while the oven is too hot may damage the oven and its surrounding cabinetry.

If the problem persists

- ① Note down the fault code.
- ② Contact Customer Care or a Fisher & Paykel trained and supported service technician. Refer to the Service and Warranty booklet for contact details.

If the fault code has disappeared, the fault has been reset and you can continue to use your oven.

FAULT CODE	POSSIBLE CAUSE	WHAT TO DO
A1	The oven has overheated.	<ul style="list-style-type: none">• Allow the oven to cool down.• Once the oven has cooled down and the door has unlocked, the alert code will disappear. You can now use the oven.
F + number	Technical fault.	<ul style="list-style-type: none">• Note down the alert code.• Wait until the cooling fans have stopped and the oven has completely cooled down.• Turn the power to the oven off at the wall.• Contact a Fisher & Paykel trained and supported service technician or Customer Care.

MANUFACTURER'S WARRANTY AND SERVICE GUIDE

US



To access your Warranty and Service Guide

Scan the QR code with your smartphone to access your warranty and book a service, refer to your separate warranty and service book or view online at <https://www.fisherpaykel.com/us/help-and-support/warranty-information>

CA



To access your Warranty and Service Guide

Scan the QR code with your smartphone to access your warranty and book a service, refer to your separate warranty and service book or view online at <https://www.fisherpaykel.com/ca/help-and-support/warranty-information>

This product has been designed for use in a domestic (residential) environment. This product is not designed for any commercial use. Any commercial use by the customer will affect this product's Manufacturer's Warranty.

Complete and keep for safe reference:

Model _____

Serial No. _____

Purchase Date _____

Purchaser _____

Dealer _____

City _____

State _____

Zip _____

Country _____

FISHERPAYKEL.COM

© Fisher & Paykel Appliances 2024. All rights reserved.

The models shown in this guide may not be available in all markets
and are subject to change at any time.

The product specifications in this guide apply to the specific products and
models described at the date of issue. Under our policy of continuous product
improvement, these specifications may change at any time.

For current details about model and specification availability in your country,
please go to our website or contact your local Fisher & Paykel dealer.

432073A 09.24