

FISHER & PAYKEL

FRONT LOADING CLOTHES WASHER

**WM1490F, WM1490P, WM1480P
& WM1280J models**

INSTALLATION GUIDE / USER GUIDE

GB IE SG

CONTENTS

Introduction	3
Safety and warnings	4
Installation instructions	6
Before you do your first wash	13
Getting started quickly	14
Washer controls	20
Safety features	21
Sorting and loading	22
Detergent and fabric softener	24
Wash cycles	28
Wash cycle options	31
Customising wash cycles	35
Caring for your washer	36
Before you call for service	39
Fault codes	41
Troubleshooting	42
Consumption data table	47
Product Fiche (according to EU 1061/2010)	48
Manufacturer's Warranty	49
Customer Care	51
European Directive 2012/19/EU on Waste Electrical and Electronic Equipment (WEEE)	53

IMPORTANT!

SAVE THESE INSTRUCTIONS

The models shown in this user guide may not be available in all markets and are subject to change at any time. For current details about model and specification availability in your country, please go to our website www.fisherpaykel.com or contact your local Fisher & Paykel dealer.

Registration

Register your product with us so we can provide you with the best service possible.

To register your product visit our website: www.fisherpaykel.com

INTRODUCTION

Welcome

Thank you for buying a Fisher & Paykel clothes washer. We are proud of this washer and trust it will serve you well for many years.

At Fisher & Paykel we aim to provide innovative products that are simple to use, ergonomic and kind to the environment. Your washer has numerous wash cycles and options so you can perform every wash task with ease and the knowledge your clothes are receiving the best possible care.

Please take the time to read these instructions carefully before you begin using your machine.

Following the advice in this user guide will ensure you get the performance you expect from your machine and that you get the best possible wash results. Keep these instructions for future reference.

We hope you enjoy your new washer. We have certainly enjoyed designing it for you.

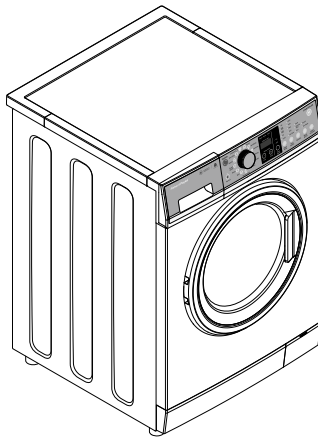

Front loading washer

IMPORTANT SAFETY INSTRUCTIONS

WARNING!

When using this appliance always exercise basic safety precautions including the following:

- This clothes washer is not intended for use by persons (including children aged below 8 years) with reduced physical, sensory, or mental capabilities, or lack of experience and knowledge, unless they are supervised or given instructions on how to use the washer by someone responsible for their safety and they understand the hazards involved.
- The washer should only be used for washing and rinsing of textiles where this is indicated on the care label.
- The door will be locked from the start of the cycle until the cycle is complete for safety reasons. It is possible to open the door during the cycle under certain conditions (refer to page 21).
- Never force the door open.
- Keep children away from the washer while it is in operation.
- Children of less than 3 years should be kept away unless continuously supervised.
- Cleaning and user maintenance shall not be made by children without supervision.
- Supervise children to ensure they do not play with the washer or climb inside the drum.
- Do not touch the glass part of the door during a cycle as the door can become hot.
- Do not open the detergent dispenser during the cycle as hot water may come out of it.

SAFETY AND WARNINGS

- **The only user-removable parts of the washer are the inlet hoses, detergent dispenser and the pump filter. No other parts are designed to be removed by anyone other than a Fisher & Paykel trained and supported service technician.**
- **When disposing of the washer, it is recommended that the door is removed to avoid children getting trapped inside, and that the electrical cable is cut off close to the washer.**

INSTALLATION INSTRUCTIONS

Accessories

Please check you received the following accessories with your Fisher & Paykel washer. You will find them inside the drum or attached to the packaging.

- 2 x Inlet hoses
- 1 x Drain hose guide
- 1 x Installation instructions and user guide
- 1 x Spanner
- 1 x Installation leaflet (attached to the top of the washer)
- 1 x Inlet valve cap
- 1 x Hose clamp

Unpacking

To ensure the best performance from your new washer please follow the instructions below.

Removing the packaging

- ① Remove the outer packaging (including the polystyrene packer and plastic wrapping). All packaging must be removed prior to use. Ensure these materials are kept out of reach of children. Note: a small amount of water may be seen inside the packaging and inside the washer. This is the result of factory testing and is normal.
- ② Tilt the machine backwards and 'walk' it off the base one foot at a time. Not doing so may cause damage to your floor and washer.
- ③ Remove all packaging and accessories from inside the drum.

Removing the transit bolts

The clothes washer is fitted with 4 transit bolts at the rear to avoid damage during transportation.

IMPORTANT!

The 4 transit bolts MUST be removed prior to operation of the machine. Failure to remove these will result in damage to the machine.

To remove the bolts:

- ① Use a spanner or socket to unscrew and remove all four transit bolts at the back of the washer (**A**).
- ② Pull the black rubber grommets to remove the bolt, grommet and white plastic spacers from the machine. Keep the transit bolts in case they are required for future transit of the machine. **Never transport the machine without the transit bolts properly fixed in place.**
- ③ Cover the bolt holes with the white plastic plugs which are attached to the machine and located near each hole (**B**). Push to clip into place.

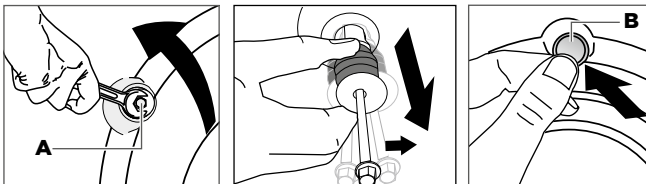

Removing the transit safety bolts

INSTALLATION INSTRUCTIONS

Product dimensions

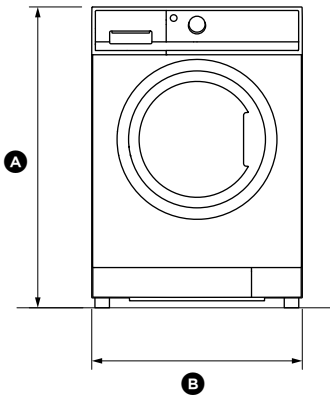

FRONT VIEW

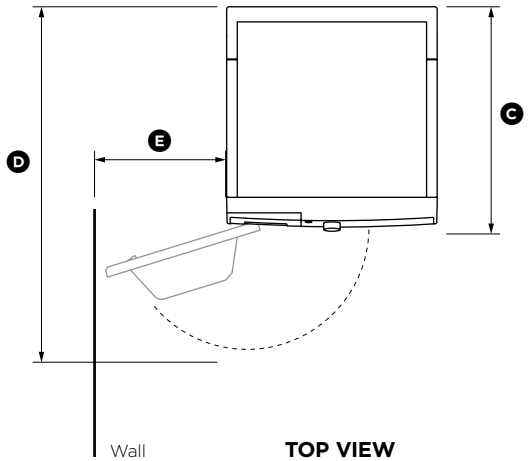

TOP VIEW

PRODUCT DIMENSIONS	WM1490F WM1490P	WM1480P WM1280J
	mm	mm
(A) Overall height of product	850	850
(B) Overall width of product	600	600
(C) Overall depth of product (excluding dial and door when closed)	645	570
(D) Depth of door open	1065	1010
(E) Minimum door clearance to adjacent wall	330	330
Standpipe height	min. 800 - 1200	min. 800 - 1200
MAXIMUM CAPACITY	kg	kg
	9.0	8.0

Note: the exact height of your washer is dependent on how far the feet are extended from the base of the machine. The space where you install your washer needs to be at least 40mm wider and 20mm deeper than its dimensions.

- Electrical supply: 220 - 240V, 50Hz Sinusoidal, minimum 10A.
- Inlet water static pressure: Max. 1MPa (150psi), Min. 30kPa (4.5psi).
- Inlet water flow rate at tap: Min. 6 litres/min.

INSTALLATION INSTRUCTIONS

Location

IMPORTANT!

Install the machine on a solid and level floor surface ensuring it has at least 20mm clearance on each side. The washer must not be installed on any textured floor coverings (eg carpet, rugs).

Note: this machine must not be installed and operated on a plinth.

Levelling the machine

It is **IMPORTANT** to level the machine to ensure good spin performance, and to minimise noise, vibrations and wear and tear on the washer.

- ① Before positioning the machine in its final position, check that the machine is level, front to back and side to side.
- ② Manoeuvre the product into its final position (we suggest a minimum clearance of 20mm each side).
- ③ Use a spirit level to check that the machine is correctly level. If needed, pull the machine out. Loosen the lock nut using the spanner provided and wind the feet up or down to correctly level the machine.
- ④ Using the spanner provided, tighten the lock nuts against the base of the machine to lock the feet in position.

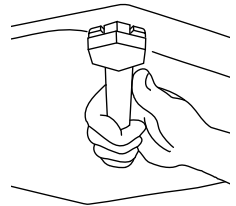

Locking the feet

Connecting to the water supply

Inlet hoses

IMPORTANT!

- **New hose sets provided with the washer should be used to connect the washer to the water mains.**
- **Old hose sets should not be re-used.**
- **We recommend the inlet hoses are changed every 5 years. WARNING: Failure to do so may result in a flood and damage to property.**

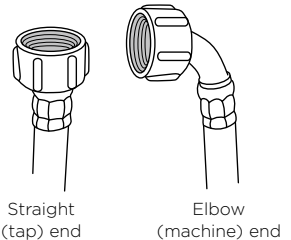

Inlet hose ends

- ① Connect the straight ends of the inlet hoses to the taps and the elbow ends to the corresponding machine inlet valves. The hot valve is colour coded orange to make this easier. Tighten the inlet hose ends by hand until the hose seal makes contact with the tap sealing face and then tighten a further half-turn. Make sure there are no kinks in the hoses.
- ② Turn the taps on and check for leaks. Check for leaks again after 24 hours.

IMPORTANT!

The hot water temperature should not exceed 65°C and the cold water temperature not exceed 35°C. Temperatures above these may cause the machine to fault or cause damage to the machine.

INSTALLATION INSTRUCTIONS

If you have an uncontrolled water heating source (eg a wet back or solar heating system) you should fit a Hot 'N' Safe Valve. This will ensure the hot water temperature remains within safe limits.

Hot 'N' Safe Valves available are:

RMC TVA 50HF

RMC TVA 75HFS

Adjustable between 35°C - 55°C

RMC TVA 50HP

For instantaneous gas hot water supply

Water supply requirements:

- Inlet water pressure: Maximum 1MPa (150psi), Minimum 30kPa (4.5psi)
- Inlet water flow rate: Minimum 6 litres/minute

Cold supply only:

If you only have a cold water supply, the inlet valve cap (blanking cap) which came with your washer must be connected to the hot inlet valve. The cap prevents water leaking out of the hot valve. This appliance incorporates backflow protection complying with AS3500.1. No further backflow protection is required for connection to the water supply.

Note: your washer has an internal heater to heat water. If you do not connect a hot water inlet hose, your washer will automatically recognise there is no hot water supply and its internal heater will heat the cold water to the selected cycle temperature.

INSTALLATION INSTRUCTIONS

Draining

Drain hose placement in a stand pipe or tub

- ① To guide the drain hose over the tub or standpipe the hose guide must be fitted to the drain hose. The height of the standpipe or tub should be between 800 - 1200mm.
- ② Secure the hose guide so it cannot become dislodged from the standpipe or tub.

IMPORTANT!

- **If the drain hose is placed on the ground or if the standpipe or tub is less than 800mm high, the washing machine will continuously drain while being filled (siphon).**
- **Regularly check that your standpipe or tub is free from lint or other obstructions, which may affect how your machine works or may cause flooding.**

Attaching drain hose to spigot

- ① Guide drain hose through hose guide
- ② Secure hose guide to back wall of cupboard using a screw. The height of the drain hose should be between 500 - 800mm from ground level.
- ③ Attach drain hose to spigot and secure using a hose clamp ensuring the blanking insert is cleared from spigot.
- ④ Check for leaks.

- The drain hose should be checked from time to time and replaced if any damage (eg wear, cuts, bulges, kinks, leaks, etc) is found. Do not bend the drain hose sharply, as this may cause it to split.
- In multi-storey apartments or any upper floor, the machine should be installed on a floor equipped with a drain.
- Draining must comply with local by-laws.

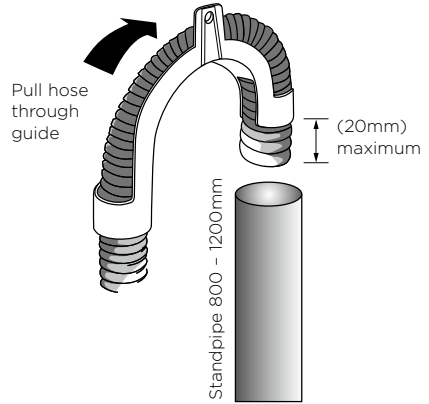

Fitting the drain hose guide

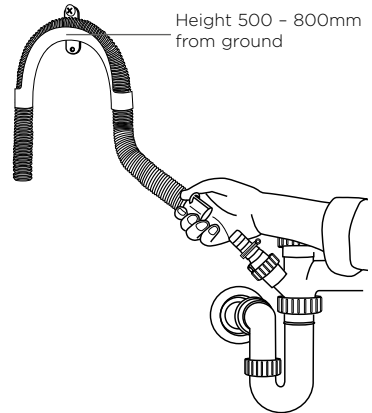

Attaching drain hose to spigot

INSTALLATION INSTRUCTIONS

Electrical connection

- ① This appliance must be connected to a 220V – 240V, 50Hz, sinusoidal, minimum 10A electrical supply.
 - ② Uncoil the power cord, remove and discard the plastic pin cover and plug into a wall socket.
 - ③ Connect the appliance to an earthed outlet protected by a fuse of suitable capacity.
- Check the power cord for damage and make sure it is not squashed or twisted when installing the washer.
 - Always remove the power cord from a socket by the plug, not by the cord.

IMPORTANT!

- **If you are using an extension cord or a portable electrical outlet device (eg multi-socket outlet box), ensure that it is positioned so that it does not come into contact with water or moisture. FAILURE TO DO SO MAY RESULT IN DEATH OR ELECTRICAL SHOCK.**
- **Do not touch or operate the machine with wet hands or with bare-feet.**
- **A damaged power cord must be replaced by a Fisher & Paykel trained and supported service technician, in order to avoid a hazard. The appliance must not be operated until it is repaired, as there is risk of electric shock.**
- **Do not operate this machine if it has been damaged during transport. Contact your Fisher & Paykel dealer or Fisher & Paykel trained and supported service technician.**

SPARE PARTS

Available from your Fisher & Paykel dealer or a Fisher & Paykel trained and supported service technician.

Hose Inlet Long (2m)	Part No. 422680P
Hose Inlet Large Bore	Part No. 426123P
Drain Hose Extension (Not suitable for attaching to a spigot).	Part No. 425627P

INSTALLATION INSTRUCTIONS

Completing the installation

Installation test cycle

IMPORTANT!

Do this before you wash any items in your washer. This is to check that your washer is installed correctly and that it is functioning correctly prior to use.

- ① Turn your washer on by pressing the 'POWER' button.
- ② Select the 'Quick' or 'Super Quick' cycle. Ensure the drum is empty and the door closed.
- ③ Touch the ►|| button. The machine will start to fill.
 - Observe the machine for any problems (eg leaking from the hoses, excess noise or vibrations).
 - The washer will beep and display any faults on the screen if there are any problems. Refer to 'Before you call for Service' section at the back of this book.
- ④ Wait until you see water in the bottom of the drum.
- ⑤ Touch ►|| to stop the cycle, then press 'POWER' to turn the machine off.
- ⑥ Press 'POWER' again, select the 'Spin' cycle and touch ►||.
 - Check the drain hose is firmly secured to the standpipe or tub, or spigot.
 - Observe that the machine pumps out the water, and spins.

IMPORTANT!

If there are any problems, you must address these before proceeding with normal use. The washer will automatically turn off at the end of the cycle if there are no problems.

BEFORE YOU DO YOUR FIRST WASH

Before you start, it is a good idea to go through the following checklist:

- ① Have the packaging and transit bolts been removed?
- ② Is the drain hose threaded through the 'U bend' (with no more than 20mm extended) and hooked into your standpipe or tub, or attached to a spigot?
- ③ Is the hot hose connected to the hot valve (colour-coded orange)? Is the cold hose connected to the cold valve (colour-coded white)? Have the taps been turned on?
- ④ Is the machine correctly levelled, feet are locked and cabinet corners clear of the floor and walls?
- ⑤ Has the power cord been connected to an appropriate power supply and the power turned on?
- ⑥ Have you performed the installation test cycle?
- ⑦ We recommend you complete your first cycle with a half-load amount of detergent and without a load in order to remove any residues remaining in the machine from the manufacturing process.

IMPORTANT!

You must ensure all 4 transit bolts have been removed from your washer before you start using it. If the transit bolts are not removed, they will damage your washer and YOUR MANUFACTURER'S WARRANTY WILL BE COMPROMISED.

GETTING STARTED QUICKLY

WM1490F model only

- Sort your washing carefully. Separate white/light colours from dark colours. Wash new, highly coloured and dark coloured items separately to prevent dye transfer. Refer to the 'Sorting and loading' section.
- Load your clothes individually into the wash drum. Close the door.
- Use '**Low Sudsing**' or '**Front Loader**' liquid, powder or **Pods**. Place liquid detergent into the correct compartment in the dispenser drawer marked **(II)**. If you wish to use powdered detergent you **MUST** remove the liquid detergent insert by firmly grasping and twisting the left hand side of the internal compartment and pulling upwards. If you are using detergent pods place them at the back of the drum before you load your clothing. For more information on detergent refer to the 'Detergent and fabric softener' section.
- If you wish to use fabric softener, place it in the compartment marked with a **(*)**. For more information on fabric softener refer to the 'Detergent and fabric softener' section.

IMPORTANT!

Fabric softener should not be used if you have selected the 'Super Quick' cycle.

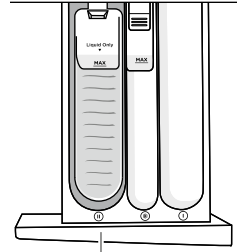

Liquid detergent in compartment marked **(II)**

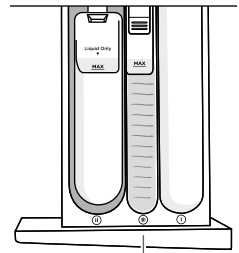

Fabric softener in compartment marked **(*)**

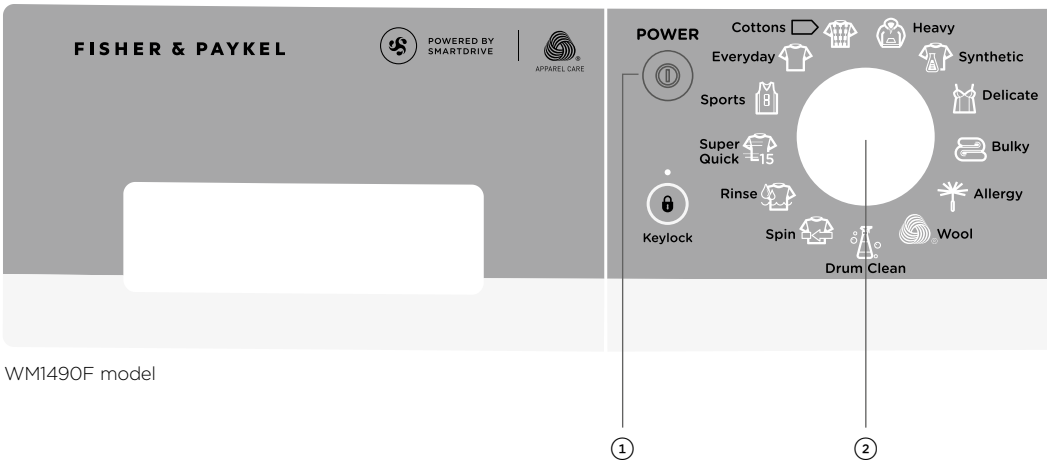

WM1490F model

GETTING STARTED QUICKLY

- ① Press 'POWER' to activate your washer.
- ② Select your wash cycle by turning the SmartTouch™ Control Dial.
- ③ Choose your wash options, if you wish to select options different from the default options for the cycle.
- ④ Touch ►|| to start the cycle.

- If you make an invalid selection the washer will beep to alert you.
- When the cycle finishes, your washer will perform end of cycle beeps and then turn off automatically.
- If you wish to stop your washer at any point during a cycle simply touch ►|| to pause the cycle. There may be a slight delay while the drum comes to a stop, then the door will unlock. Under certain conditions however the door will remain locked for safety reasons (refer to the 'Safety features' section).
- If you wish to cancel or change the wash cycle once a cycle has started, simply touch the ►|| button then select the new cycle. Touch ►|| to restart the washer.

IMPORTANT!

- **For the best fabric and colour care, remove your clothes as soon as the cycle has finished.**
- **Failure to follow the advice in this guide may result in damage to your garments and your expectations of wash performance may not be met.**

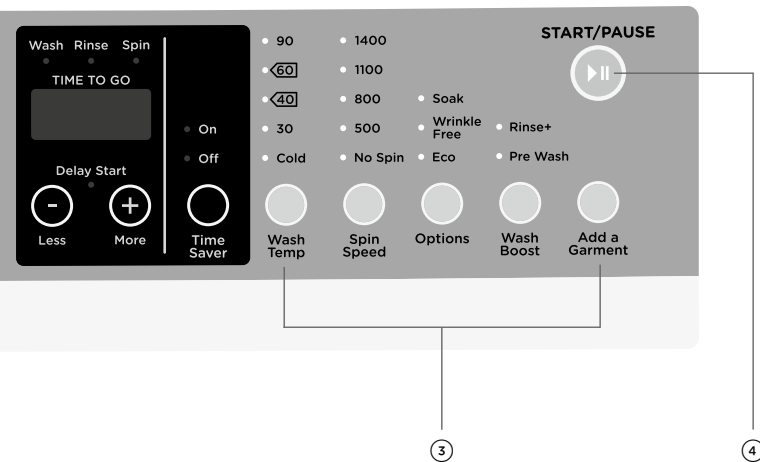

GETTING STARTED QUICKLY

WM1490P and WM1480P models only

- Sort your washing carefully. Separate white/light colours from dark colours. Wash new, highly coloured and dark coloured items separately to prevent dye transfer. Refer to the 'Sorting and loading' section.
- Load your clothes individually into the wash drum. Close the door.
- Use '**Low Sudsing**' or '**Front Loader**' liquid, powder or **Pods**. Place liquid detergent into the correct compartment in the dispenser drawer marked **(II)**. If you wish to use powdered detergent you **MUST** remove the liquid detergent insert by firmly grasping and twisting the left hand side of the internal compartment and pulling upwards. If you are using detergent pods place them at the back of the drum before you load your clothing. For more information on detergent refer to the 'Detergent and fabric softener' section.
- If you wish to use fabric softener, place it in the compartment marked with a **(*)**. For more information on fabric softener refer to the 'Detergent and fabric softener' section.

IMPORTANT!

Fabric softener should not be used if you have selected the 'Quick' or 'Super Quick' cycles.

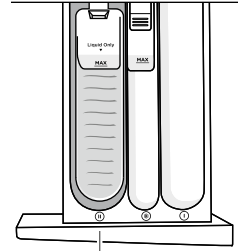

Liquid detergent in compartment marked **(II)**

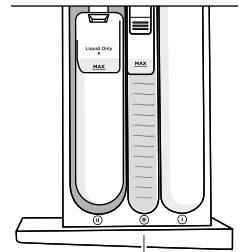

Fabric softener in compartment marked **(*)**

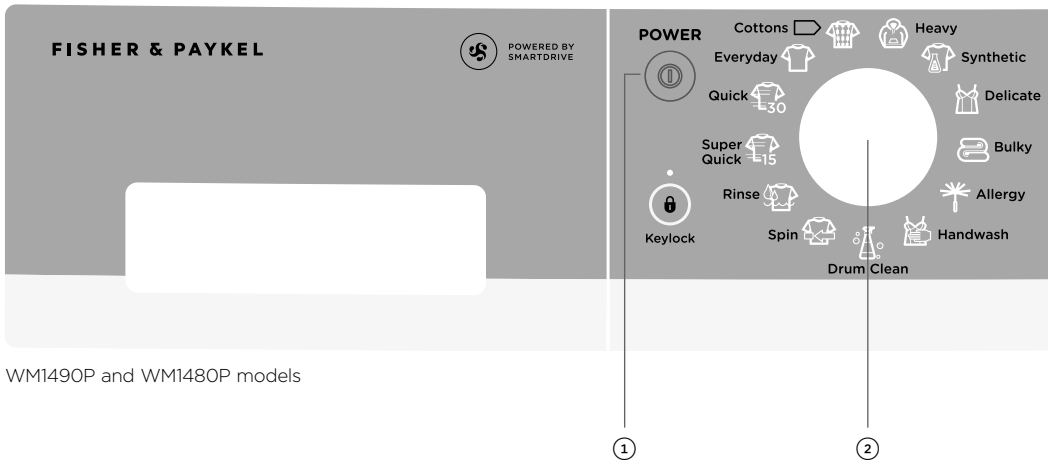

WM1490P and WM1480P models

GETTING STARTED QUICKLY

- ① Press 'POWER' to activate your washer.
- ② Select your wash cycle by turning the SmartTouch™ Control Dial.
- ③ Choose your wash options, if you wish to select options different from the default options for the cycle.
- ④ Touch ►|| to start the cycle.

- If you make an invalid selection the washer will beep to alert you.
- When the cycle finishes, your washer will perform end of cycle beeps and then turn off automatically.
- If you wish to stop your washer at any point during a cycle simply touch ►|| to pause the cycle. There may be a slight delay while the drum comes to a stop, then the door will unlock. Under certain conditions however the door will remain locked for safety reasons (refer to the 'Safety features' section).
- If you wish to cancel or change the wash cycle once a cycle has started, simply touch the ►|| button then select the new cycle. Touch ►|| to restart the washer.

IMPORTANT!

- **For the best fabric and colour care, remove your clothes as soon as the cycle has finished.**
- **Failure to follow the advice in this guide may result in damage to your garments and your expectations of wash performance may not be met.**

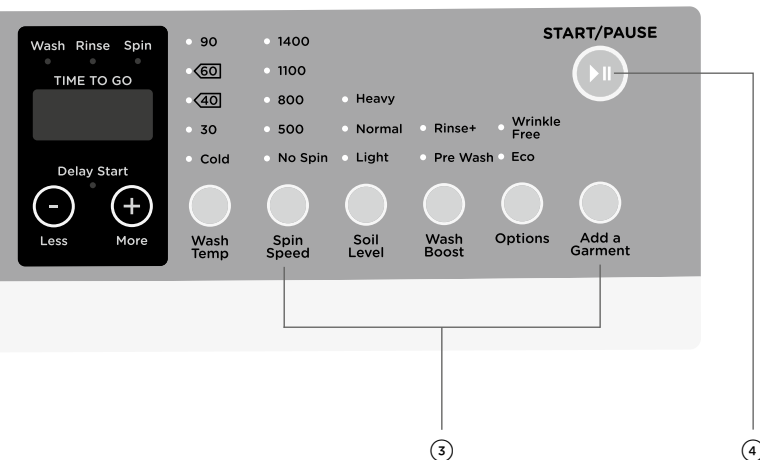

GETTING STARTED QUICKLY

WM1280J model only

- Sort your washing carefully. Separate white/light colours from dark colours. Wash new, highly coloured and dark coloured items separately to prevent dye transfer. Refer to the 'Sorting and loading' section.
- Load your clothes individually into the wash drum. Close the door.
- Place detergent in the correct compartment in the detergent dispenser drawer marked **2**. Use **Low Sudsing** or '**Front Loader**' liquid or powder detergents. Alternatively use detergent pods. Place the pod at the back of the drum before you load in any clothing. For more information on detergent refer to the 'Detergent and fabric softener' section.
- Place fabric softener in the compartment marked with a . For more information on fabric softener refer to the 'Detergent and fabric softener' section.

IMPORTANT!

Fabric softener must not be used if you have selected the 'Quick' cycle.

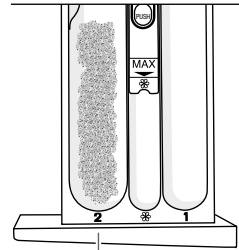

Detergent in compartment marked **2**

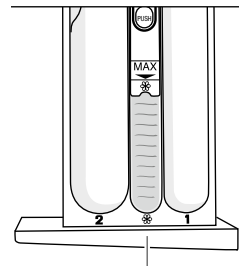

Fabric softener in compartment marked 

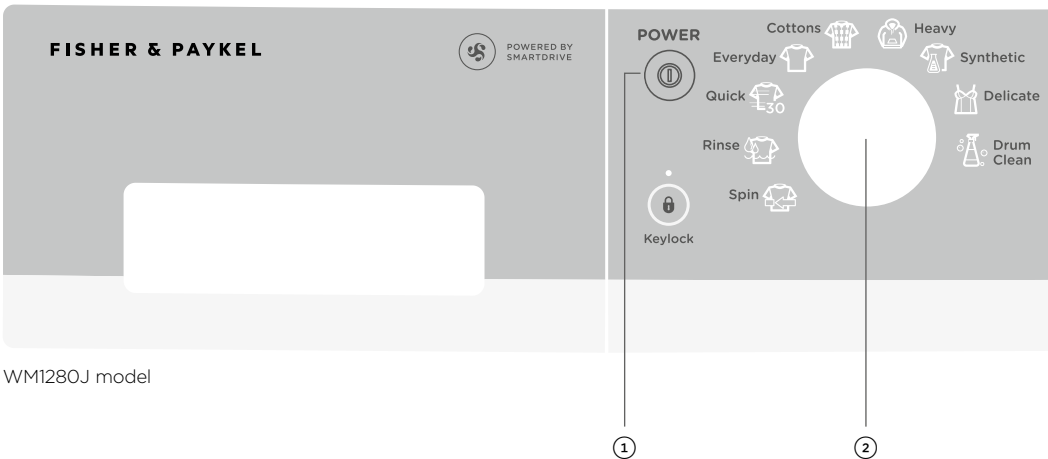

GETTING STARTED QUICKLY

- ① Press 'POWER' to activate your washer.
- ② Select your wash cycle by turning the SmartTouch™ Control Dial.
- ③ Choose your wash options, if you wish to select options different from the default options for the cycle.
- ④ Touch ►|| to start the cycle.

- If you make an invalid selection the washer will beep at you.
- When the cycle finishes, your washer will perform end of cycle beeps to alert you and then turn off automatically.
- If you wish to stop your washer at any point during a cycle, simply touch ►|| to pause the cycle. There may be a slight delay while the drum comes to a stop, then the door will unlock. Under certain conditions however the door will remain locked for safety reasons (refer to the 'Safety features' section).
- If you wish to cancel or change the wash cycle once a cycle has started, simply touch the ►|| button then select the new cycle. Touch ►|| to restart the washer.

IMPORTANT!

- **For the best fabric and colour care, remove your clothes as soon as the cycle has finished.**
- **Failure to follow the advice in this guide may result in damage to your garments and your expectations of wash performance may not be met.**

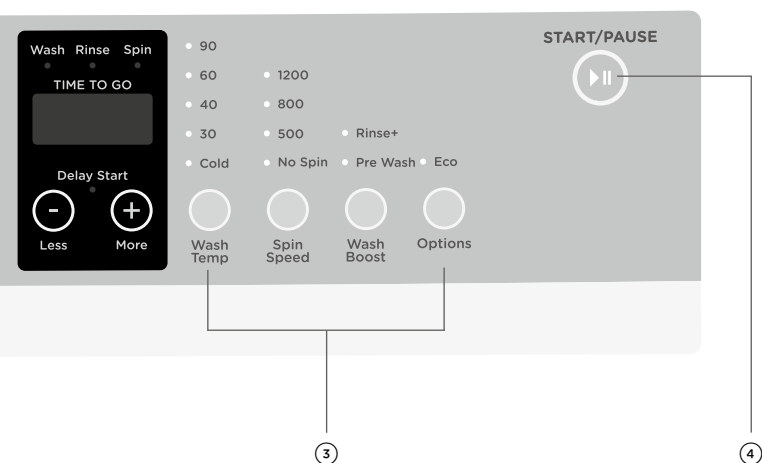

WASHER CONTROLS

SmartTouch™ Control Dial

The SmartTouch™ Control Dial provides easy and efficient wash cycle selection. As you rotate the dial, the icon of the wash cycle selected will be illuminated, along with the default settings for that cycle on the right side of the control panel.

SmartTouch™ buttons

The smooth, easy clean buttons enable easy selection of options with lights clearly showing the selections you are making.

Digital display screen

The digital display screen provides feedback on how long the wash cycle has to go. If you have programmed a 'Delay Start', the time remaining until the cycle will start will be displayed here, along with any messages to help you with the overall running of your washer (eg user warnings).

Time to go

Your washer displays approximately how many minutes the cycle you are running has remaining, so that you can tell at a glance when your washing will be finished.

Please be aware that a number of factors can influence the overall cycle time, eg the water flow rate, water pressure, whether hot water is being used from the tap or the water is heated by the internal heater, load size, cycle and option selections. Therefore cycle times will vary. Unexpected events in a wash cycle (eg out of balance, oversudsing) can lengthen the cycle time.

Progress lights

The progress lights indicate what part of the cycle the washer is currently on (wash, rinse or spin). All three lights are on at the beginning of the cycle. The light for the current part of the cycle flashes.

Keylock mode

Keylock can be used to lock the buttons on your washer. This will avoid accidental button pushes. For more detail please refer to the 'Wash cycle options' section.

Drum light (WM1490F model only)

Your machine has a drum light to help assist you when loading and unloading your washing machine. When you press 'POWER', the LED light in the drum will turn on, after 2 minutes it will automatically turn off. At the end of the cycle, the drum light will turn on again for 5 minutes to help facilitate unloading.

SAFETY FEATURES

Door lock

The door of your washer will lock once you touch ►|| until the machine beeps at the end of the cycle, ensuring safety for you and your family while your machine is operating.

To unlock the door during the cycle

- You can open the door to add or remove items during the wash simply by touching the ►|| button. Note: the door will remain locked if the temperature inside the washer is above 60°C and/or the water level is above the bottom of the door seal (a warning will be displayed in these circumstances, refer to 'Before you call for service').
- Simply touch ►||, the machine will pause and the door will automatically unlock if the conditions inside the washer are safe. The ►|| button and time to go will flash on the screen while the washer is paused. Open the door and remove or add garments. Close the door and touch ►|| to resume the cycle.

Add a Garment (WM1490F, WM1490P and WM1480P models only)

The 'Add a Garment' function can be used to interrupt the cycle to add or remove a garment at any time during the wash part of the cycle (as long as the wash temperature selected is lower than 60°C). Water in the machine will be drained to a level where the door can be opened, if necessary. Refer to 'Wash cycle options' for more information.

Opening the door during a power failure

If there is a power failure during a wash cycle your washer will stop and the door will remain locked. You can unlock the washer door to remove your clothes by opening the pump filter cover at the bottom right of your washer. Simply place a coin or key in the slot and tilt it upwards to lever the cover open, then pull the door release tab.

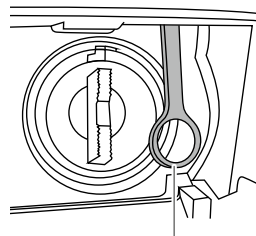

Door release tab

Manual door opening mechanism

IMPORTANT!

Do not attempt to do this if the water level in the washer is above the level of the door.

When power is restored you will need to restart your machine by simply pressing 'POWER'. The washer will remember where in the cycle it was up to.

Your washer also has the following protective measures:

- Flood protection - turns off valves and turns pump on if a flood condition is detected.
- Out-of-balance protection - stops and redistributes the load if an unbalanced load condition is sensed, and/or slows the spin speed to compensate.
- Excess suds protection - pauses to allow suds to break down before continuing the cycle.

SORTING AND LOADING

When preparing your wash load there are some important things to consider:

Sorting

Sort items according to colour, fabric type, and soil type. Wash fine, delicate fabrics separately from thick, heavy fabrics. Always separate coloured items from whites, especially when they are new. Colour run could be an issue if you wash items at higher temperatures. Some soils, like mud and blood are best washed in cold water. Oily soils (eg some foods and marks on shirt collars) are best washed in warm water. The following are recommendations for what cycles and settings you may wish to wash different items on, and suggestions for special wash requirements.

ITEMS/WASH REQUIREMENTS	SUGGESTED CYCLE AND OPTIONS*	SUGGESTED TEMPERATURE
Towels	Everyday, 1400 or 1200 rpm spin	30°C or 40°C
Sheets, pillowcases	Everyday, 1400 or 1200 rpm spin	30°C or 40°C
Bulky items - doonas, duvets, sleeping bags	Bulky	30°C or 40°C
Polycotton items	Synthetic, 1100 or 1200 rpm spin	40°C
Woollens, silks	Wool, Handwash, 500 rpm	30°C or 40°C
Delicates, fine fabrics	Delicate, Wool or Handwash	30°C
Jeans	Everyday or Heavy	Cold or 30°C
Highly coloured items	Everyday	Cold or 30°C
Whites, cotton items	Cottons, 1400 or 1200 rpm spin	40°C or 60°C
Have sensitive skin or require extra rinsing?	Allergy, Rinse+, 1400 or 1200 rpm spin	40°C
Asthma/allergies	Allergy, Rinse+	60°C
Lightly soiled items	Quick, Super Quick or TimeSaver	30°C
Muddy, sandy or linty items	Everyday, Pre Wash and Rinse+	Cold
Smelly washer	Drum Clean	90°C

* Cycles and spin speeds available will depend on your washer model.

SORTING AND LOADING

Before you load

- Check pockets for items that could damage your clothes or get caught in the washer.
- Close zippers, hooks and eyes, and other fastenings (ie fasten the opening of duvet/ doona covers), and remove loose bra wires. All these can damage both your washer and your clothes.
- Place delicate items, such as lingerie, in a mesh laundry bag before placing in the machine.
- Pre-treat any stains, taking care not to spray pre-treaters on your washer as they can cause damage to the plastic surfaces.

Loading

Your washer will be more efficient when washing larger loads, so try to collect enough items to loosely fill the drum when the items are dry.

IMPORTANT!

- **Do not overload your washing machine beyond its rated capacity.**
- **Please do not under any circumstances wash an electric blanket in your washer unless the care label specifically states it is safe to do so.**
- **Do not wash curtains in this washer, as sunlight makes them brittle and they may disintegrate during washing.**

DETERGENT AND FABRIC SOFTENER

Detergent type

Your washer requires low sudsing detergent to prevent oversudsing problems. Low sudsing detergent comes in powder, liquid or pod form and is labelled 'Front Loading', 'Low Suds', 'High Efficiency' or 'HE'.

Using top loading detergent in your front loader washer may lead to excessive suds formation, which will lengthen the cycle time as the machine waits for the suds to dissolve.

Where do I put my detergent?

WM1490F, WM1490P and WM1480P models only

Liquid detergent

Is added to the main wash compartment on the left side of the dispenser drawer marked with a **(II)** (A). As the machine fills, water is flushed into this compartment and is mixed with the detergent, the detergent solution is then delivered into the drum. There may be a small volume of water left in the liquid detergent dispenser at the end of the cycle. This is normal.

Powdered detergent

If you wish to use powdered detergent, the liquid detergent compartment **MUST** be removed from the dispenser drawer. To do this firmly grasp and twist the left hand side of the internal compartment and pull upwards (B). To replace the liquid detergent compartment slide it back into the drawer marked **(II)** (C). Press down in the middle until it clicks (D).

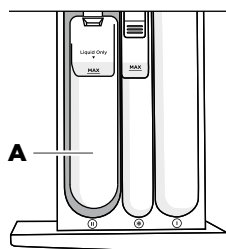

Detergent dispenser drawer

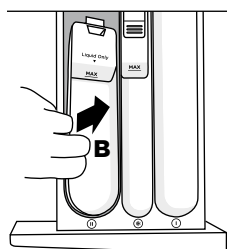

Removing the liquid detergent compartment

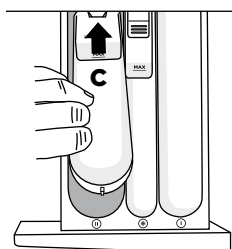

Replacing the liquid detergent compartment

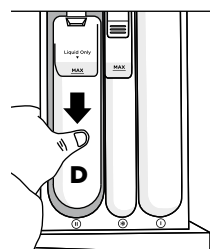

Clicking in the liquid detergent compartment

IMPORTANT!

- If using liquid detergent ensure the liquid detergent compartment is installed.
- If using powder ensure the liquid detergent compartment has been removed.
- Make sure the detergent drawer is completely closed before starting the cycle.

DETERGENT AND FABRIC SOFTENER

WM1280J model only

Powdered or liquid detergent

Is added to the main wash detergent compartment on the left side of the dispensing drawer marked with a **2**. As the machine fills, water is flushed through this compartment to deliver a detergent solution into the drum.

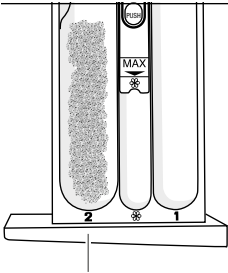

Detergent in the detergent compartment marked **2**

IMPORTANT!

- **Make sure the detergent drawer is completely closed before starting the cycle.**
- **If you select the 'Pre Wash' option, you must use a powdered detergent in the main wash detergent compartment.**

Pods

Detergent pods are a 'no mess' alternative to powdered or liquid detergent. They must be placed at the back of the drum prior to loading your clothes. This will ensure they are activated quickly in the wash. Do not place pods in the detergent dispenser drawer or on top of your clothes.

Pre Wash

If you wish to use the 'Pre Wash' option, liquid or powdered detergent only must be placed in the pre wash detergent compartment on the right side of the drawer, marked with either a **1** or **1**. When you select 'Pre Wash', the pre wash compartment is flushed at the start of the cycle. For more information refer to 'Wash cycle options'.

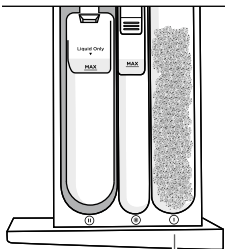

Detergent in the pre wash compartment marked **1**

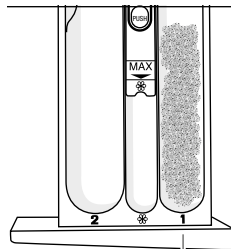

Detergent in the pre wash compartment marked **1**



'Pre Wash' option

IMPORTANT!

- **Make sure the detergent dispenser drawer is completely closed before starting the cycle.**
- **WM1280J model: If using 'Delay Start' we recommend you use powdered detergent for the main wash.**

How much detergent?



The correct detergent dosage varies depending on the amount of soil in your load, the size of the load and the water quality, so getting the correct dose takes some trial and error. Use the instructions stated on the detergent package as a guide, then alter the dosage according to the results.

If you overdose, you will get over foaming issues, but if you under-dose you will get poor performance and over time your washer will start to smell as scum builds up inside it.

Detergent advice

- ① If your washer smells you are probably not using enough detergent for the soil level in your loads. Run a 'Drum Clean' cycle and either buy a better quality detergent or use a higher dose. If you are using an 'Eco' detergent, alternate the use of this with a mainstream detergent.
- ② Add the detergent BEFORE starting the cycle, close the dispenser and do not open it while the cycle is running.
- ③ If you find foam leaking from your washer, check you are using a low sudsing or front loader type detergent and check the quantity you are using against the detergent manufacturers recommendation. You may need to reduce the amount you are using.

Fabric softener

Add fabric softener to the middle compartment of the dispenser marked with a  or a . The washer will automatically flush the fabric softener during the rinse part of the cycle.

If you wish to use fabric softener we recommend to:

- ① Use it sparingly. Measure it carefully and do not use more than 25mls (1/2 cap), some thicker varieties may need diluting.
- ② Clean your dispenser regularly.
- ③ Clean your machine regularly using the 'Drum Clean' cycle.
- ④ Complete wash cycles at a wash temperature of 40°C or above at regular intervals (eg every 5th wash) as washing in cold water increases the chance of scrud occurring (see below).

Note: if you fill beyond the MAX mark, the fabric softener will be dispensed into the bowl prematurely and contribute to scrud.

Scrud

Scrud is the name of the waxy build-up that can occur within any washer when fabric softener comes in contact with detergent. This build-up is not brought about by a fault in the machine. If scrud is allowed to build up in the machine it can result in stains on clothes and an unpleasant smell in your washer.

If you wash a particularly dirty load, we recommend putting the washer through a 'Rinse' cycle once the cycle has finished and the load has been removed, to clean out any remnants from that cycle.

WASH CYCLES

WM1490F model



Your washer has a number of wash cycles to suit your laundering needs. Selecting the most appropriate cycle for each particular wash load will help ensure you get the best wash result.

CYCLE	DESIGNED FOR	DESCRIPTION	MAX. LOAD SIZE (kg)	DEFAULT WASH TEMP. (°C)	MAX. WASH TEMP. (°C)	DEFAULT SPIN SPEED (rpm)	MAX. SPIN SPEED (rpm)
Cottons*	Normally soiled everyday cotton loads, eg whites.	A comprehensive cycle specifically designed for cottons.	9.0	40	90	1400	1400
Everyday	Normally or lightly soiled everyday items, eg towels, sheets, sweatshirts, t-shirts.	A faster cycle designed for mixed loads with normal soiling.	8.0	40	90	1400	1400
Heavy	Heavy soiled durable garments eg tea towels, rugby shorts.	A stronger, hotter wash for more durable items.	8.0	60	90	1400	1400
Delicate	Delicate, lightly soiled items, eg tops, blouses.	Gentler wash with more water to look after delicate items.	4	40	60	500	800
Synthetic	Normally soiled, everyday synthetic or mixed clothing items, eg business shirts, t-shirts.	A cycle tailored to washing synthetic and mixed fabric types.	4	40	60	1100	1100
Bulky	Washing bulky items.	A warm, gentle wash and slow spin for special care of bulky items.	4	60	90	800	800
Allergy	Asthma sufferers and people with skin sensitivities.	Hot wash to kill dust mites and extra rinses to remove all traces of detergent.	8.0	60	90	1400	1400
Wool**	Machine washable woollen items.	Extra gentle wash action that complies with Woolmark Apparel Care criteria.	2	40	40	800	800
Super Quick	Freshening up small musty or lightly soiled items.	A quick cycle for small lightly soiled loads.	2	30	60	800	1400
Sports	Cotton/synthetic sports clothing.	A cycle tailored to washing sports type clothing.	4	40	40	1100	1400
Rinse	Items that require rinsing only.	Two rinses followed by a spin.	9.0	Cold	Cold	1400	1400
Spin	Spinning wet items.	Spin only.	9.0	N/A	N/A	1400	1400
Drum Clean	Maintaining the cleanliness of your washer.	A hot cycle to remove any residues inside the washer.	-	90	90	1400	1400

* 'Cottons', '40°C' and '60°C', 'Eco', and '1400 rpm' are the standards energy testing and labelling cycles in accordance with EN 60456 and EU directive 2010/30/EU. These are the standard cotton programmes for normally soiled cotton laundry. They are the most efficient programmes in terms of combined energy and water consumption for cotton laundry. The water temperature may differ from declared cycle temperature.

** Woolmark Apparel Care

The wool wash cycle of this machine has been approved by The Woolmark Company for the washing of machine washable wool products provided that the products are washed according to the instructions on the garment label and those issued by the manufacturer of these washing machines M1528. Only the WM1490F model complies with Woolmark Apparel Care requirements.



WASH CYCLES

WM1490P and WM1480P models

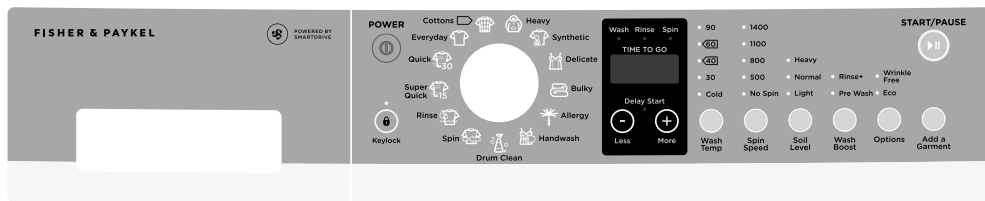

Your washer has a number of wash cycles to suit your laundering needs. Selecting the most appropriate cycle for each particular wash load will help ensure you get the best wash result.

CYCLE	DESIGNED FOR	DESCRIPTION	MAX. LOAD SIZE (kg)*	DEFAULT WASH TEMP. (°C)	MAX. WASH TEMP. (°C)	DEFAULT SPIN SPEED (rpm)*	MAX. SPIN SPEED (rpm)*
Cottons**	Normally soiled everyday cotton loads, eg whites.	A comprehensive cycle specifically designed for cottons.	9.0 or 8.0	40	90	1400	1400
Everyday	Normally or lightly soiled everyday items, eg towels, sheets, sweatshirts, t-shirts.	A faster cycle designed for mixed loads with normal soiling.	8.0 or 7.0	40	90	1400	1400
Heavy	Heavy soiled durable garments eg tea towels, rugby shorts.	A stronger, hotter wash for more durable items.	8.0 or 7.0	60	90	1400	1400
Delicate	Delicate, lightly soiled items, eg tops, blouses.	Gentler wash with more water to look after delicate items.	4	40	60	500	800
Synthetic	Normally soiled, everyday synthetic or mixed clothing items, eg business shirts, t-shirts.	A cycle tailored to washing synthetic and mixed fabric types.	4	40	60	1100	1100
Bulky	Washing bulky items.	A warm, gentle wash and slow spin for special care of bulky items.	4	60	90	800	800
Allergy	Asthma sufferers and people with skin sensitivities.	Hot wash to kill dust mites and extra rinses to remove all traces of detergent.	8.0 or 7.0	60	90	1400	1400
Handwash	Very delicate lightly soiled garments, eg woollens.	Very gentle wash action for extra special items.	2	30	40	500	500
Quick	Lightly soiled garments.	A quick cycle for lightly soiled loads.	4	40	60	800	1400
Super Quick	Freshening up small musty or lightly soiled items.	A quick cycle for small lightly soiled loads.	2	30	60	800	1400
Rinse	Items that require rinsing only.	Two rinses followed by a spin.	9.0 or 8.0	Cold	Cold	1400	1400
Spin	Spinning wet items.	Spin only.	9.0 or 8.0	N/A	N/A	1400	1400
Drum Clean	Maintaining the cleanliness of your washer.	A hot cycle to remove any residues inside the washer.	-	90	90	1400	1400

* Depends on your model of washer (9.0kg or 8.0kg capacity).

** 'Cottons', '40°C' and '60°C', with 'Normal Soil', 'Eco' and '1400 rpm' are the standards energy testing and labelling cycles in accordance with EN 60456 and EU directive 2010/30/EU. These are the standard cotton programmes for normally soiled cotton laundry. They are the most efficient programmes in terms of combined energy and water consumption for cotton laundry. The water temperature may differ from declared cycle temperature.

WASH CYCLES

WM1280J model



Your washer has a number of wash cycles to suit your laundering needs. Selecting the most appropriate cycle for each particular wash load will help ensure you get the best wash result.

CYCLE	DESIGNED FOR	DESCRIPTION	MAX. LOAD SIZE (kg)	DEFAULT WASH TEMP. (°C)	MAX. WASH TEMP. (°C)	DEFAULT SPIN SPEED (rpm)	MAX. SPIN SPEED (rpm)
Cottons*	Normally soiled everyday cotton loads, eg whites.	A comprehensive cycle specifically designed for cottons.	8.0	40	90	1200	1200
Everyday	Normally or lightly soiled everyday items, eg towels, sheets, sweatshirts, t-shirts.	A faster cycle designed for mixed loads with normal soiling.	7.0	40	90	1200	1200
Heavy	Heavy soiled durable garments eg tea towels, rugby shorts.	A stronger, hotter wash for difficult stains on durables.	7.0	60	90	1200	1200
Delicate	Delicate, lightly soiled items, eg tops, blouses.	Gentler wash with more water to look after delicate items.	4	40	60	500	800
Synthetic	Normally soiled, everyday synthetic or mixed clothing items, eg business shirts, t-shirts.	A cycle tailored to washing synthetic and mixed fabric types.	4	40	60	1200	1200
Quick	Lightly soiled garments.	A quick cycle for lightly soiled loads.	4	40	60	800	1200
Rinse	Items that require rinsing only.	Two rinses followed by a spin.	8.0	Cold	Cold	1200	1200
Spin	Spinning out wet items.	Spin only.	8.0	N/A	N/A	1200	1200
Drum Clean	Maintaining the cleanliness of your washer.	A hot cycle to remove any residues inside the washer.	-	90	90	1200	1200

* 'Cottons', '40°C' and '60°C', 'Eco' and '1200 rpm' are the standards energy testing and labelling cycles in accordance with EN 60456 and EU directive 2010/30/EU. These are the standard cotton programmes for normally soiled cotton laundry. They are the most efficient programmes in terms of combined energy and water consumption for cotton laundry. The water temperature may differ from declared cycle temperature.

WASH CYCLE OPTIONS

All wash cycles default to the recommended options for that cycle based on the average expected load to be washed. You can vary the options (eg 'Wash Temp', 'Spin Speed') to create your desired cycle. Note: some options are not available on some cycles, for clothes care reasons, or because the option is not appropriate for the cycle.

To change a wash option or options you have selected after a cycle has started, touch ►|| and select your new setting, then touch ►|| again to resume the cycle with the new setting or settings. Note: some options may not be available for selection under certain conditions and after particular stages of the cycle have passed.

Wash Temp

Your washer offers five wash temperatures:

Cold	30°C	40°C	60°C	90°C
------	------	------	------	------

- Simply touch the 'Wash Temp' button to increase or decrease the wash temperature.
- The washer will fill with both hot and cold water to achieve the selected wash temperature. If required the washer will heat the water to the selected temperature.
- Some temperatures are not available on some cycles as a safeguard for your clothes (eg 90°C on the 'Delicate' cycle).

IMPORTANT!

When 90°C temperature is selected, the door glass will become hot. Do not touch the glass part of the door. Keep children away from the washer.

Time Saver (WM1490F model only)

Your washer offers a 'Time Saver' feature that when selected adjusts the cycle programming, by combining special temperature profiling and a unique tumble sequence. The result – excellent wash performance combined with time savings.

This option can be selected on the 'Everyday', 'Cottons', 'Heavy', 'Easy Iron', 'Allergy' and 'Sports' cycles.

Please be aware that a number of factors can influence the amount of time saved on a cycle, including the load size, cycle chosen, water flow rate and load distribution during spin.

Spin Speed

- Your WM1490F, WM1490P or WM1480P model of washer offers four spin speeds: 500 rpm, 800 rpm, 1100 rpm and 1400 rpm, plus an additional 'No Spin' option.
- Your WM1280J model of washer offers three spin speeds: 500 rpm, 800 rpm, 1200 rpm, plus an additional 'No Spin' option.
- Simply increase or decrease the spin speed by touching the 'Spin Speed' button.
- Selecting 'No Spin' will end the cycle after the rinse, allowing you to remove items you wish to drip dry. Note: the washer will complete the default wash and rinse spins for the cycle; only the final spin will not be completed. If you have removed the items you wish to drip dry and there are items remaining that you would like to proceed to spin, press 'POWER' and select the 'Spin' cycle. If necessary, modify the spin speed to best care for your load (ie spin delicate items at 500 rpm for best garment care).

WASH CYCLE OPTIONS

Soil Level (WM1490P and WM1480P models only)

The 'Soil Level' option lets you adjust the wash to suit the amount of soil in your load. For example, select 'Heavy' for dirty clothes; for items that are only lightly soiled, select 'Light'. This adjusts the wash time accordingly to give the load the right amount of agitation to remove the soil.

Wash Boost

Pre Wash

For extra dirty loads you can perform a 'Pre Wash'. Your washer will start the wash with a short wash in cool water to remove excess soil. After this the machine will drain and then fill at the selected temperature for the main wash.

Simply touch the 'Wash Boost' button and select 'Pre Wash' when choosing your wash options. Note: 'Pre Wash' cannot be selected after a wash cycle has been started, ie if you touch ►II and try to select 'Pre Wash' it will be unavailable. 'Pre Wash' must be selected at the start of the cycle.

If you use the 'Pre Wash' option, liquid or powdered detergent needs to be placed in the correct detergent compartment. The pre wash compartment is on the right hand side of the drawer, marked ① or 1. When you select 'Pre Wash', the compartment is flushed at the start of the cycle.

WM1490F, WM1490P and WM1480P models only

The detergent for the main wash can either be a powder or a liquid. Place this in the compartment marked ②. If using liquid, ensure the internal compartment is installed.

WM1280J model only

The detergent for the main wash MUST be a powder, and should be placed in the compartment marked 2.

Rinse+

If you have a particularly dirty load, or you have sensitive skin and wish to give your clothes an extra rinse, select 'Rinse+' from the 'Wash Boost' options. Your load will undergo an extra rinse to get rid of any residual detergent or soil in the items.

Note: 'Rinse+' will not be available if the 'Eco' option has been selected.

WASH CYCLE OPTIONS

Options

Soak (WM1490F model only)

A soak option is available on selected wash cycles. When this option is chosen the machine will add a one hour soak sequence, which combines periods of tumbling with soaking to help lift stubborn stains.

If 'Soak' and 'Time Saver' are selected in the same cycle, the soak duration will be reduced to 30 minutes.

'Soak' is not available on 'Wool', 'Drum Clean', or 'Super Quick' cycles.

Wrinkle Free (WM1490F, WM1490P and WM1480P models only)

We recommend you remove the clothes from the washer immediately after the completion of the cycle to minimise wrinkling and creasing of items and to prevent dye run. However, if you will not be present at the end of the wash you can select 'Wrinkle Free'.

When 'Wrinkle Free' is selected, the washer will tumble the clothes once every 15 minutes for up to 12 hours after the cycle has finished. The 'Wrinkle Free' light and ►|| button will flash, and the washer will beep at regular intervals to remind you to remove your load. To remove the load during this phase, simply press the ►|| button.

Eco

Use the 'Eco' option to save water and energy. Selecting 'Eco' will reduce the wash temperature slightly and alter the wash and rinse programming.

Note: this option will not be available if 'Pre Wash' has been selected.

- **If you wish to, you can select both the 'Pre Wash' and 'Rinse+' 'Wash Boost' options to perform on the same cycle. Likewise, you can select 'Eco' and 'Wrinkle Free' to perform on the same cycle. Touch the appropriate button until both options are selected. Repeat to deselect an option.**
- **For clothes care and performance reasons not all options may be available on some cycles.**

Add a Garment (WM1490F, WM1490P and WM1480P models only)

The 'Add a Garment' option enables you to add or remove items during the wash stage of the cycle, under certain conditions. Once the 'Add a Garment' button is touched, the ►|| button and time to go will flash. Wait until you hear the door unlock. Open the door and add or remove items. Close the door and touch ►|| to restart the cycle. The 'Add a Garment' button will only operate during the wash part of the cycle and when the temperature selected is lower than 60°C. 'Add a Garment' can be used when the total wash volume has been reached, as your washer will drain the water to a lower level if necessary, so the door can be opened.

WASH CYCLE OPTIONS

Keylock



This option enables you to deactivate the buttons on the display panel, except for the 'Power' and 'Keylock' buttons. This prevents accidental button presses.

To turn Keylock mode ON or OFF when the washer is powered on:

- Touch and hold the  button for 2 seconds.





Note: when activated, the light above the  button is illuminated.

If Keylock mode is activated and the machine is powered off:



- To turn your washer on, press the 'POWER' button, then touch and hold the  button for two seconds. Select your wash cycle, options and then touch  to start the cycle.
- To turn the washer off at anytime when keylock is activated simply press the 'POWER' button.

Delay Start

The 'Delay Start' option enables you to delay the start of the wash cycle from between 5 minutes and 12 hours. Times you can select are 5 min, 15 min, 30 min, 1 hour, then hourly up to 12 hours. This can be useful to time your washing to finish when you arrive home from work, or to start once you have finished in the shower. Some stain removers also require you to spray them on then leave for several minutes, before washing. Your washer will wait for the selected time then start without you having to wait or remember to start your machine.

To programme a 'Delay Start' time, simply touch the 'More'  button to increase the delay time and 'Less'  button to decrease the time or turn 'Delay Start' off. Touch  to confirm your selection and start the countdown. Once started, the time will count down on the digital display screen in 1 minute increments, the 'Delay Start' light will flash and the  light will stop flashing and turn on solid.

Note: if you hold the 'More'  button down, the time displayed on the screen will increase after every half a second (more convenient than touching the button repetitively).

To remove a 'Delay Start' time once it is counting down, simply touch  , then touch the 'Less'  button to decrease the time to zero. Touch  to start the cycle immediately.

Note: we suggest that you avoid using 'Delay Start' for damp, non-colourfast items as this may cause dye run to occur. We also recommend you use powder detergent when you use the 'Delay Start' function (WM1280J model only).

CUSTOMISING WASH CYCLES

After using your washer a few times you may discover there are some wash options you prefer for some cycles.

You can programme your washer to remember the wash options you prefer for each wash cycle. For instance, you may want to set the 'Easy Iron' cycle to cold wash temperature or set the 'Everyday' cycle so it gives you Rinse+ every cycle.

To customise a cycle:

- ① Press 'POWER' to turn the machine on.
- ② Turn the dial to select the cycle you wish to customise.
- ③ Touch and hold any of the wash option buttons for 3 seconds. The cycle icon will flash on and off to indicate that the product is in cycle adjustment mode. The display will show *SEt*.
- ④ Select the wash options you prefer by touching the relevant option button.
- ⑤ Touch **⏸** to save the selected settings.

Your washer will automatically remember your changes for all future washes you do on this cycle.

Factory Reset

You can reset your washer to the default settings it left the factory with:

- ① Turn the dial to select 'Spin'.
- ② Touch and hold the 'Delay Start' 'More' **+**, the 'Delay Start' 'Less' **-** and 'Options' buttons together for 3 seconds *dEF* will appear on the screen and the machine will beep.
- ③ Your washer will now be reset to the default settings.

CARING FOR YOUR WASHER

When you have finished using your washer

- Unplug the machine from the power socket.
- Wipe around the door and in the rubber gasket to remove any remaining water and foreign matter.
- Turn off the taps to prevent the chance of flooding should a hose burst.

Cleaning your washer

Before you start cleaning your washer, ensure that it is disconnected from the power (ie unplug the machine from the power socket).

Cleaning the control panel and outer surfaces of the washer

Use a soft damp cloth to wipe all surfaces, then wipe dry. Avoid using chemical or scouring cleaners, as these will damage the paint and plastic surfaces of your washer.

Cleaning the detergent dispenser drawer

Wipe out the detergent dispenser drawer with a damp cloth. Clean it regularly, especially if you use fabric softener. To remove the drawer, pull it open, push down on the tab in the fabric softener compartment and pull out. Rinse it out under warm water and replace.

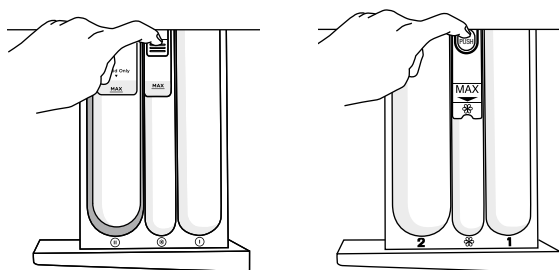

Removing the dispenser drawer for cleaning

Cleaning the inside of your washer

It is important that you regularly clean the inside of your machine using the 'Drum Clean' cycle. After 100 cycles  icon will flash every time you turn your washer on to remind you to do this.

If your washer starts to smell this is a sign that you should complete a 'Drum Clean' cycle. We recommend that you do not have any items in the washer when you run this cycle.



'Drum Clean' cycle

Cleaning steps

- ① Add approximately 2 full scoops of a good quality powdered detergent directly into the main wash detergent compartment of the dispenser drawer (marked **1** or **2**) or use a drum cleaning product specifically designed for front loading washing machines (follow manufacturer's instructions).
- ② Press 'POWER' to turn your machine on and select the 'Drum Clean' cycle.
- ③ Touch **▶||** to start the cycle (refer to the 'Wash cycles' section).

CARING FOR YOUR WASHER

Cleaning the drum and the door

- Use a soft damp cloth to wipe the door, cleaning any water marks or residue off it.
- Wipe the rubber seal around the door. Remove any items or lint accumulating in the bottom of the seal catchment and wipe out any water accumulated here. If this is not cleaned out, unpleasant odours will develop.
- If the drum has any residual dirt or lint stuck to it, remove this and wipe the drum clean. Do not leave any metal objects in the drum as these may rust and cause staining.
- The WM1490F model also has a self cleaning door flush that directs a portion of the rinse water over the door during various stages of the cycle to help to clean hair and insolubles from the inside of the door and surrounding parts. We still recommend that you manually clean it with a soft cloth periodically as per the instructions above.

Cleaning the pump filter

The pump has a filter to trap foreign objects that enter the washer along with clothing. The pump filter can be accessed from the front of the washer.

To clean the filter:

This should be cleaned out approximately once a month.

- ① Turn the power off and unplug the machine.
- ② Use a coin to open the filter cover. Place the edge of the coin into the slot and tilt upwards whilst levering the cover open.
- ③ Unhook the pump outlet hose and pull it out (about 150mm). Remove the plug and allow any water (approximately 250ml) to drain into a shallow dish.
- ④ After the draining process is complete, replace the plug into the hose and refit the hose back into the housing.
- ⑤ Remove the filter by turning anti-clockwise. Clean and rinse under a tap. Check the pump filter cavity for any further obstruction.
- ⑥ Replace the filter by turning clockwise until the white mark on the filter is in line with the white line on the pump housing.

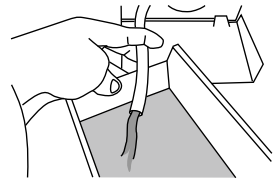

Drain residual water

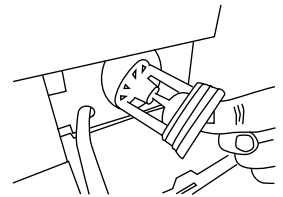

Replacing filter

White marks are in line

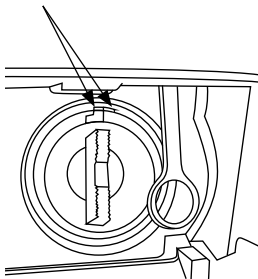

Correct

White marks are not in line

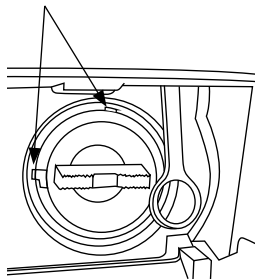

Incorrect

White mark on filter must be in line with white line on pump housing

- ⑦ Close the filter cover.

CARING FOR YOUR WASHER

Cleaning the hoses

Each hose has a filter in it, preventing any solid contaminants in the water entering your washing machine. Occasionally you should disconnect the water inlet hoses where they connect to the taps, check these for any build up of dirt and wash this out.

Nappy sanitisers/bleach

Nappy sanitisers and bleach are very corrosive to metal surfaces. DO NOT tip the contents of a nappy bucket into your machine. Rinse and wring items out thoroughly before placing them in the machine.

Moving your washer

If you need to move your washer a considerable distance (eg moving house), **remember to replace the transit bolts before moving it.** These will protect internal components of the washer from damage.

To replace the transit bolts, pull out the bolt-hole covers in the back of the machine. Push the transit bolt rubber grommets and plastic spacers into the hole left and tighten it with the spanner provided with the product.

Make sure any water in the washer is drained out. This can be done by cleaning out the pump filter (refer to 'Caring for your washer' section 'Cleaning the pump filter').

IMPORTANT!

- **Leave the door to your washer open when it is not in use to allow the washer to dry out, otherwise it will develop unpleasant odours. When leaving the door open like this, it is extremely important that children and pets are kept away from the washer so they cannot be accidentally trapped inside it.**
- **Aside from the detergent dispenser, water hoses, and the pump filter, no other parts are designed to be removed from the machine for cleaning. Do not attempt to remove any other part of the machine.**

BEFORE YOU CALL FOR SERVICE

User warnings

Your washer is capable of diagnosing a number of its own problems. In most cases, your washer will sound a continuous series of beeps and display a code when it has a problem that you can correct yourself. All control panel lights will turn off and the code will be displayed to inform you what the problem is. To stop the beeps, press any button on the control panel. Do not try to continue washing once you stop the noise. You must address the problem the washer is alerting you to.

Check this chart before you call for service.

PROBLEM	DISPLAYED AS	WHAT TO DO
Keylock is activated.	KEY LOC	Touch and hold the 'Keylock' button for 2 seconds.
Pump filter is blocked.	CLF FLTR	Clear the pump filter (refer to page 37).
Water is not getting to the machine.	no tAP	<p>Check the taps have been turned on.</p> <p>If there is no hot water connection the machine will heat the water itself, but there must be a cold water connection to the cold valve.</p> <p>Check the hose connections. If the cold water supply is connected to the hot valve and there is no connection to the cold valve the machine will not fill.</p> <p>Check the inlet hose filters are not blocked, the hoses are not kinked and are attached correctly.</p> <p>Check that the drain hose is not too low or pushed into the standpipe too far. This will cause the water to siphon out of the machine.</p> <p>Check the cold water temperature does not exceed the 35°C temperature requirement.</p> <p>Check the water flow rate. It maybe too low.</p>
Wash load is out of balance.	out OF BAL	<p>Touch ► to try the spin again.</p> <p>If the out of balance persists, pause the cycle, manually redistribute the load and touch ► to spin again. If necessary, stop the cycle, select 'Spin' and touch ► .</p> <p>If the problem persists, check the machine is correctly levelled.</p>

BEFORE YOU CALL FOR SERVICE

PROBLEM	DISPLAYED AS	WHAT TO DO
Too many suds.	<i>Sud LOC</i>	<p>Machine will stop and flash <i>Sud LOC</i> for 10 minutes while waiting for suds to dissipate. The machine will not beep during this time. After 10 minutes the machine will automatically restart. At any point during that 10 minutes you can touch ► to restart the machine, but it is recommended that the machine be left to restart automatically.</p> <hr/> <p>Check you are using a suitable detergent.</p> <hr/> <p>Check you are not overdosing the detergent.</p> <hr/> <p>Check the standpipe height for the drain does not exceed 1200mm.</p>
Door is locked.	<i>door Locd</i>	<p>The temperature in the drum is over 60°C therefore it is not safe to open the door. Wait until the temperature drops below 60°C.</p> <hr/> <p>Check the water level in the drum. If the level is above the bottom of the door seal, the door cannot be opened. Use the 'Add a Garment' button if you wish to add or remove items (WM1490F, WM1490P and WM1480P models only).</p> <hr/> <p>If the drum is still moving, wait for it to stop before attempting to open the door.</p>
Door is open.	<i>door OPEN</i>	<p>Close the door fully and touch ► .</p> <hr/> <p>Try opening and closing the door again.</p> <hr/> <p>Reposition the load, make sure the load is correctly in the drum and that protruding items are not stopping the door from closing.</p>

FAULT CODES

When a continuous series of beeps is sounded, all the lights turn off on the control panel and a number appears on the display, a fault has occurred. The washer will automatically enter this mode if a fault occurs. The fault code will be displayed as *E r r* followed by a number on the digital display. To stop the sound, touch any button and perform the following steps:

- ① Turn your machine off at the power point.
- ② Wait one minute and turn it back on.
- ③ Check your machine is correctly levelled (refer to page 8).
- ④ Remove your wash load.
- ⑤ Perform a 'Rinse' cycle.
- ⑥ If the fault re-occurs repeat steps ① and ②.
- ⑦ If the machine still will not work you will be required to call a Fisher & Paykel trained and supported service technician to arrange service (refer to the 'Customer Care' section). Record the fault code number displayed and the serial number of your washer (located on the rear of the machine, and/or above the drum opening when the door is open) before calling. The fault code will indicate to the Repairer what the problem could potentially be.

If a fault code is being displayed, you can still turn your washer off by pressing 'POWER'.

TROUBLESHOOTING

The following is a list of problems you may encounter when using this appliance and some suggestions that may help to correct the problem. If you still have problems, please contact your Fisher & Paykel trained and supported service technician.

Solving operating problems

PROBLEM	POSSIBLE CAUSES	WHAT TO DO
Washer not turning on.	Power not switched on at the wall.	Switch the power on at the wall. Then press 'POWER'.
	Household power supply not working.	Try plugging in another electrical appliance.
	Keylock may be activated.	Touch and hold the 'Keylock' button for 2 seconds (refer to page 34).
Touching ► does not start the fill.	Washer door not closed properly.	Open and reclose door.
	The washer is waiting for a command from you.	If ► is flashing then the washer is waiting for a command from you.
	The washer has detected a fault.	Check if a code is being displayed on the panel (refer to pages 39 - 41).
	Hot and cold taps not turned on.	Check that both hot and cold taps are turned on (if using cold inlet only ensure inlet valve cap is installed on the hot valve on the machine).
	Hot and cold taps not connected to the corresponding valve on the machine.	Check the cold tap is connected to the cold valve on the machine and the hot tap is connected to the hot valve.
	Blocked hose filters.	Check the tap end of the inlet hoses for blockages.
	Inlet hose leaking, twisted or damaged.	Check the inlet hose for leaks or damage. Check that the inlet hose is not twisted.
	Faulty water supply.	Check taps that aren't connected to the machine are working.
	Delay start maybe set.	Refer to page 34.
Washer stops working mid cycle.	The washer has detected a fault.	Refer to pages 39 - 41.
	Power or water failure.	Check the power and/or water is working correctly.
	Washer has been paused.	Touch the ► button to continue.
	Too many suds.	Washer is waiting for suds to dissolve before continuing the cycle.

TROUBLESHOOTING

Solving operating problems

PROBLEM	POSSIBLE CAUSES	WHAT TO DO
Washer drains while filling.	Drain hose too low.	Ensure the height of the drain hose is at least 800mm from the floor level (refer to page 10).
	Drain hose sitting in water.	Clear the drain.
Washer is not draining.	Drain hose blocked.	Clear the drain hose.
	Pump filter blocked.	Clear the pump filter (refer to page 37).
	Drain hose higher than 1200 mm above floor level.	Lower the level of the drain hose (refer to page 10).
Filling continuously.	Drain hose not connected to standpipe or tub.	Connect drain hose correctly (refer to page 10).
	Machine siphoning.	Ensure standpipe or tub is at least 800mm from the floor level.
Poor rinsing.	Incorrect detergent used.	Use low sudsing, front loader detergent only (refer to page 24).
	Too much detergent used.	Ensure the correct dose of detergent is used for the load size and soil level (refer to page 26).
Not spinning properly.	Load has gone out of balance.	Open door and redistribute load, then restart the washer.
	Machine is not level.	Ensure machine is correctly levelled (refer to page 8).
	Suds build up.	Check the amount of detergent used, reduce if necessary.
Too many soap suds.	Incorrect type of detergent used.	Use low sudsing, front loader detergent only (refer to page 24).
	Too much detergent used.	Ensure the correct dose of detergent is used for the load size and soil level (refer to page 26).
Small puddle of water from under the machine.	Inlet hose or drain hose leaking.	Check inlet hoses and the drain hose are correctly attached and not damaged.
	Lots of suds.	Suds may have leaked and then dissolved.
	Detergent dispenser blocked.	Clean detergent dispenser drawer (refer to page 36).
	Detergent dispenser drawer not fully closed.	Close detergent dispenser drawer fully and ensure it remains closed during the cycle.
	Damage to door seal.	Check seal inside door for damage. If it sustains any damage it will need to be replaced.

TROUBLESHOOTING

Solving operating problems

PROBLEM	POSSIBLE CAUSES	WHAT TO DO
Cycle time longer than usual/Inaccurate time reading/ Adjustment of time remaining during cycle.	Wash time is approximate.	Wash time may be influenced by a number of factors (refer to page 20).
	Low water pressure or flow rate.	Ensure that inlet hose filters are not blocked.
	Out of balance or oversudsing.	Recovery from out of balance or oversudsing will extend cycle time (refer to page 39).
	Washing a large load.	Be aware that it will take longer for the machine to fill.
Detergent or fabric softener remaining in detergent dispenser at the end of the cycle.	Selecting various options.	Be aware that some options will extend cycle time.
	Detergent drawer not properly closed or was opened part way through the cycle.	Ensure the detergent dispenser drawer is fully closed at the start of the cycle and remains closed throughout the cycle.
	Dirty or blocked detergent dispenser.	Clean the detergent dispenser (refer to page 36).
	Liquid sitting at the 'Max' level at the end of the cycle indicates a blockage.	Clean the fabric softener dispenser (refer to page 36).
	Dispenser over loaded with detergent.	Clean out remaining detergent and refer to page 26 for dosing information.
Washing very wet at the end of the cycle.	Cycle selected not appropriate.	Particularly short or delicate cycles have shorter spins which can result in wetter washing at the end of the cycle.
	Incorrect spin speed for load selected.	Select a faster spin speed.
	An out of balance load has occurred.	The washer compensates for the out of balance by using a lower spin speed, to reduce noise and potential damage to itself.
Vibrating.	Transit bolts left in place.	Ensure transit bolts are removed prior to use of the machine (refer to page 6).
	Washer may not be level.	Ensure washer is installed on an appropriate surface and levelled correctly (refer to page 8).
	Load is out of balance.	Wash an average sized load rather than a smaller load or a single item. Washing one item at a time is not recommended as it is difficult for the washer to balance a single item during spin.

TROUBLESHOOTING

Solving wash problems

PROBLEM	POSSIBLE CAUSES	WHAT TO DO
Creasing.	Washer overloaded.	Do not overload washer.
	Incorrect cycle for load type.	Use the 'Easy Iron' or 'Handwash' cycle for creasable items.
	Spin speed too fast.	Select a slower spin speed.
	Wet clothes left in washer or laundry basket.	Laundry left sitting wet is more likely to crease. If not removing clothes from washer immediately at end of cycle, select the 'Wrinkle Free' option (WM1490F, WM1490P and WH1480P models only). Do not leave wet washing sitting in a washing basket.
	Wash temperature too hot for load type.	Select a lower wash temperature. Check items care label for correct care.
	Items not sorted correctly.	Sort load so that items of similar weight are washed together (refer to page 22).
Poor soil Removal.	Incorrect wash cycle selected.	Select a wash cycle that is appropriate for the amount of dirt (refer to pages 28 - 30).
	Insufficient detergent.	Ensure the correct dose of detergent is used for the load size and soil level (refer to page 26).
	Washer overloaded.	Ensure the washer is not overloaded in terms of its capacity or the cycle selected (refer to pages 28 - 30).
	Items require a longer wash time.	Select a higher soil level option if available (WM1490P and WM1480P models only).
	Load was particularly dirty.	Select 'Pre Wash' for particularly dirty loads (refer to page 32).
	Items not sorted correctly.	Wash heavily and lightly soiled garments separately.
	Washer dirty from previous wash.	After washing particularly dirty clothing, we recommend putting the washer through a 'Rinse' cycle after the load has been removed, to wash away any remnants of dirt and to prevent it contaminating future washes.
	Incorrect wash temperature selected in relation to the type of soil.	Select a wash temperature suitable for the type of soil, eg warm for greasy soils, cold for muddy soils. Increasing the wash temperature generally improves soil removal and overall wash performance.

TROUBLESHOOTING

Solving wash problems

PROBLEM	POSSIBLE CAUSES	WHAT TO DO
Dye transfer.	Coloured items not washed separately from white/light coloured items.	Remember to separate whites and colours.
	New or non-colourfast items not washed separately.	Wash non-colourfast items separately and select 'Cold' wash temperature.
	Wet items have been left sitting for too long.	Remove items from washer as soon as the cycle is finished, or if items are not to be removed from the washer immediately select 'Wrinkle Free'.
	Wash temperature.	Consider the wash temperature you select for your coloured items. Lower the temperature if you are concerned.
Black or grey marks on clothes.	Correct amount of detergent.	Ensure the correct dose of detergent is used for the load size and soil level (refer to page 26).
	Washer needs to be cleaned.	Empty the machine and complete a 'Drum Clean' cycle (refer to page 36).
Tangling.	Items not sorted correctly.	Separate larger items from smaller items.
	Washer loaded incorrectly.	Load items loosely and individually into the washer (ie not folded).
	Incorrect cycle for load type selected.	Use the 'Easy Iron' cycle to wash shirts.
	Washer overloaded in terms of its capacity or the cycle selected.	Try washing average to smaller load sizes.
	Delicate items.	Wash pantyhose, bras and any other delicate items prone to tangling in a mesh laundry bag.

Contact a Fisher & Paykel trained and supported service technician if a problem persists.

CONSUMPTION DATA TABLE

MODEL	CYCLE	TEMP. (°C)	LOAD (kg)	PROGRAMME TIME ON DISPLAY (min)	REMAINING MOISTURE CONTENT (%)	ENERGY CONSUMPTION (kWh/CYCLE)	WATER CONSUMPTION (L/CYCLE)
WM1490F	Cottons Eco*	60	9	198	47	0.67	50
	Cottons	40	9	138	56	1.17	84
	Everyday	40	8	59	48	0.81	96
	Heavy	60	8	130	48	2.19	115
	Synthetic	40	4	121	40	0.98	53
	Delicate	40	4	45	65	0.70	65
	Sports	40	4	50	43	0.55	56
WM1490P	Cottons Eco*	60	9	198	47	0.67	50
	Cottons	40	9	138	56	1.17	83
	Everyday	40	8	59	46	0.81	92
	Heavy	60	8	130	48	2.30	121
	Synthetic	40	4	121	41	0.90	54
	Delicate	40	4	45	66	0.70	64
	Quick	40	4	30	76	0.57	51
WM1480P	Cottons Eco*	60	8	198	47	0.79	52
	Cottons	40	8	138	53	1.08	74
	Everyday	40	7	59	45	0.71	78
	Heavy	60	7	130	49	1.91	104
	Synthetic	40	4	121	40	0.90	49
	Delicate	40	4	45	66	0.61	58
	Quick	40	4	30	74	0.55	49
WM1280J	Cottons Eco*	60	8	198	49	0.79	53
	Cottons	40	8	138	58	1.08	74
	Everyday	40	7	59	52	0.71	78
	Heavy	60	7	130	54	1.91	104
	Synthetic	40	4	121	40	0.90	49
	Delicate	40	4	45	66	0.61	58
	Quick	40	4	30	74	0.55	49

Tested on default settings. Values are approximate only. Consumption will depend on how the washer is used. Actual values can vary depending on water pressure, water hardness, water inlet temperature, room temperature, environmental conditions, type and size of load, fluctuation in electricity supply and options selected.

* Values measured in accordance with EN 60456 and EU Regulation 1061/2010.

PRODUCT FICHE (ACCORDING TO EU 1061/2010)

Fisher & Paykel

MODEL	WM1490F	WM1490P	WM1480P	WM1280J
Rated capacity (kg)	9	9	8	8
ENERGY EFFICIENCY				
A+++ (highest efficiency) to D (least efficient)	A+++	A+++	A+++	A+++
ENERGY CONSUMPTION				
Annual energy consumption (kWh/year) ¹	150	150	165	165
Cotton full load at 60°C (kWh)	0.67	0.67	0.79	0.79
Cotton partial load at 60°C (kWh)*	0.72	0.72	0.80	0.79
Cotton partial load at 40°C (kWh)*	0.58	0.58	0.58	0.56
Weighted power off- mode (W)	0.18	0.18	0.18	0.18
Weighted power consumption in left- on mode (W)	0.18	0.18	0.18	0.18
Annual water consumption (L/year) ²	9200	9200	9500	9800
SPIN-DRYING EFFICIENCY CLASS³				
A (most efficient) to G (least efficient)	B	B	B	B
Maximum spin speed (rpm)	1400	1400	1400	1200
Residual moisture (%)	47	47	47	49
PROGRAMS TO WHICH THE INFORMATION ON THE LABEL AND FICHE RELATES:				
Cotton 60°C, Eco and Cotton 40°C, Eco ⁴				
PROGRAM TIME OF THE STANDARD PROGRAM (min)				
Cotton full load at 60°C	212	212	222	224
Cotton partial load at 60°C*	210	210	216	221
Cotton partial load at 40°C*	201	201	214	204
Duration of left on mode (min) ⁵	5.0	0.2	0.2	0.2
AIRBORNE ACOUSTICAL NOISE EMISSIONS⁶				
Washing (dB(A))	48	48	50	50
Spinning (dB(A))	69	69	68	66

¹ Annual energy consumption is based on 220 standard washing cycles for cotton programmes at 60°C and 40°C at full and partial load, and the consumption of low power modes. Actual energy consumption will depend on how the appliance is used.

² Annual water consumption is based on 220 standard washing cycles for cotton programmes at 60°C and 40°C at full and partial load. Actual water consumption will depend on how the appliance is used.

³ Based on the standard 60°C cotton program at full load and the 40°C cotton program at partial load.

⁴ The standard 60°C cotton program and the standard 40°C program are the standard washing programmes to which the information in the label and the fiche relates. These programmes are suitable to clean normally soiled cotton laundry and are the most efficient programmes in terms of combined energy and water consumption.

⁵ In case there is a power management system.

⁶ Based on the standard 60°C cotton program at full load.

* Partial load is half of rated capacity.

MANUFACTURER'S WARRANTY

You automatically receive a 2 year Manufacturer's Warranty with the purchase of this clothes washer covering parts and labour for servicing within the country of purchase.

Fisher & Paykel undertakes to:

Repair or, at its option, replace without cost to the owner either for material or labour any part of the product, the serial number of which appears on the product, which is found to be defective within TWO YEARS of the date of purchase.

You also receive an additional EIGHT YEAR parts only Manufacturer's Warranty on your Direct Drive motor. This additional 8-year Manufacturer's Warranty commences on the day following the expiry of the 2-year Manufacturer's Warranty and excludes the motor controller and labour. Fisher & Paykel will repair (as to parts) or, at its option, replace any Direct Drive motor (but not the motor controller) which is found to be defective within this additional Manufacturer's Warranty period. You will be responsible for any labour costs.

Note: these Manufacturer's Warranties are an extra benefit and do not affect your legal rights.

These Manufacturer's Warranties DO NOT cover

- (A) Service calls which are not related to any defect in the product. The cost of a service call will be charged if the problem is not found to be a product fault. For example:
 - ① Correcting the installation, eg removal of bottom packer and transit bolts (front loading washers), levelling the washer, adjustment of the drain to correct siphoning, noises, crossed, kinked or leaking inlet hose connections, turning on water, noises caused by the waterhammer or power supplies.
 - ② Providing instruction on use of the product or changing the set-up of the product, eg instruction on correct use of detergents and fabric softeners.
 - ③ Replacing fuses in, or correcting house wiring or correcting house plumbing, eg unblocking drains.
 - ④ Correcting fault(s) caused by the user.
 - ⑤ Noise or vibration that is considered normal, eg spin sounds, user warning beeps.
 - ⑥ Correcting damage caused by pests, eg rats, cockroaches, etc.
 - ⑦ Water on the floor due to incorrect loading or excessive suds.
 - ⑧ Blocked pumps, removal of foreign objects/substances from the washer, including the pump and inlet hose filters, eg bra wires, bread tags, nails, grit, scrud, etc.
 - ⑨ Correcting corrosion or discolouration due to chemical attack.
- (B) Defects caused by factors other than:
 - ① Normal domestic use; or
 - ② Use in accordance with the product's user guide.
- (C) Defects to the product caused by accident, neglect, misuse or 'act of God'.
- (D) The cost of repairs carried out other than by a Fisher & Paykel trained and supported service technician or the cost of correcting such repairs.
- (E) Normal recommended maintenance as set out in the product's user guide.
- (F) Repairs when the appliance has been dismantled, repaired or serviced by other than a Fisher & Paykel trained and supported service technician or the selling dealer.
- (G) Pick-up and delivery.

MANUFACTURER'S WARRANTY

- Ⓜ Transportation or travelling costs involved in the repair when the product is installed outside the Fisher & Paykel trained and supported service technician's normal service area.

Nothing in this Manufacturer's Warranty is intended to, or does limit, any rights you may have under law to recover the costs of inspecting or returning the goods to us.

This product has been designed for use in a normal domestic (residential) environment. This product is not designed for any commercial use (whatsoever). Any commercial use by a customer will affect this product's Manufacturer's Warranty.

Service under these Manufacturer's Warranties must be provided by a Fisher & Paykel trained and supported service technician (refer to the 'Customer Care' section at the back of this book). Such service shall be provided during normal business hours. This Manufacturer's Warranty certificate should be shown when making any claim.

Please keep this user guide in a safe place.

CUSTOMER CARE

Before you call for service or assistance...

Check the things you can do yourself. Refer to your user guide and check:

- ① Your product is correctly installed.
- ② You are familiar with its normal operation.
- ③ You have read the 'Before you call for service', 'Fault codes' and 'Troubleshooting' sections at the back of the book.

If after checking these points you still need assistance or parts, please refer to your nearest Fisher & Paykel trained and supported service technician, Customer Care, or contact us through our website www.fisherpaykel.com.

In the United Kingdom if you need assistance...*

Call the Fisher & Paykel Customer Care Centre and talk to one of our Customer Care Consultants.

Phone: 08000 886 605

Website: www.fisherpaykel.com

Postal address: Fisher & Paykel Appliances Ltd, Maidstone Road, Kingston, Milton Keynes, Buckinghamshire, MK10 0BD, United Kingdom

In Ireland if you need assistance...*

Call the Fisher & Paykel Customer Care Centre and talk to one of our Customer Care Consultants.

Phone: 1800 625 174 or 01-8077960

Fax: 1800 635 012

Website: www.fisherpaykel.com

Postal address: Fisher & Paykel Appliances, Unit D2, North Dublin Corporate Park, Swords, Co. Dublin

In Singapore if you need assistance...*

Call the Fisher & Paykel Customer Care Centre and talk to one of our Customer Care Consultants.

Phone: 6741 0777

Fax: 6547 0123

Website: www.fisherpaykel.com

Postal address: 150 Ubi Avenue 4, Sunlight Building #03-01A, Singapore 408825

*If you call, write or contact us via our website please provide: your name and address, model number, serial number, date of purchase and a complete description of the problem. This information is needed in order to better respond to your request for assistance.

Product details can be found on the rear of the machine, and/or above the drum opening (when the door is open).

CUSTOMER CARE

Registration

Register your product with us so we can provide you with the best service possible.
To register your product visit our website: **www.fisherpaykel.com**

Complete and keep for safe reference:

Model _____

Serial No. _____

Purchase Date _____

Purchaser _____

Dealer _____

Suburb _____

Town _____

Country _____

EUROPEAN DIRECTIVE 2012/19/EU ON WASTE ELECTRICAL AND ELECTRONIC EQUIPMENT (WEEE)

This appliance is marked according to the European directive 2012/19/EU on Waste Electrical and Electronic Equipment (WEEE). By ensuring this product is disposed of correctly, you will help prevent potential negative consequences for the environment and human health, which could otherwise be caused by inappropriate handling of this product.

The symbol  marked on the serial plate, or on the documents accompanying the product, indicates that this appliance can not be treated as household waste. It shall be handed over to the applicable collection point for the recycling of electrical and electronic equipment. Disposal of the appliance shall be carried out in accordance with local environmental regulations for waste disposal.

For more detailed information about treatment, recovery, and recycling of this product, please contact your local city office, your household waste disposal service or your Fisher & Paykel retailer/dealer from whom you purchased this product.

FISHERPAYKEL.COM

© Fisher & Paykel Appliances 2017. All rights reserved.

The product specifications in this booklet apply to the specific products and models described at the date of issue. Under our policy of continuous product improvement, these specifications may change at any time. You should therefore check with your Dealer to ensure this booklet correctly describes the product currently available.

GB IE SG

429258 C 08.17