

# Series 9, Contemporary Double DishDrawer Dishwasher

Series 9 | Contemporary

Black Stainless Steel



<p>Wash one drawer while you load the other, with minimal bending and room in each drawer for full-size dinner plates.</p>

- Six wash programs, as well as additional Quick wash, Sanitise and Extra Dry options
- Flexible racking allows you to customise internal shelves to suit your needs

## DIMENSIONS

Height	820 - 880 mm
Width	599 mm
Depth	573 mm

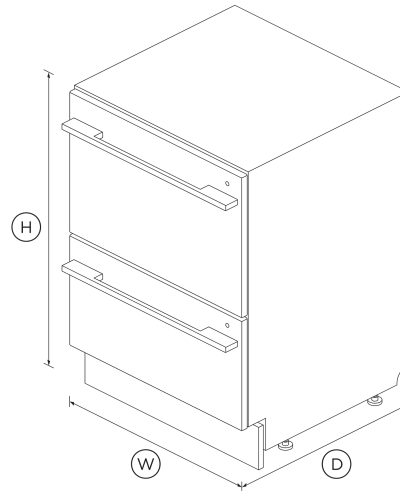

## FEATURES & BENEFITS

### Quick, Sanitise and Extra Dry options

The Quick wash modifier delivers a faster wash while maintaining performance. The Sanitise option provides extra protection, killing 99.9% of bacteria in the final rinse. The Extra Dry setting is perfect for plastic dishes.

### Ease Of Use

DishDrawer™ Dishwashers are as easy to open and close as kitchen drawers, and can be conveniently positioned at bench height for ease of loading and minimal bending. Flexible racking allows you to make adjustments to fit in a variety of dishes.

### Independent Washing

With the ability to use both drawers independently and select different wash programs, the DishDrawer™ Dishwasher can wash everything from fine glass and crystal to heavily soiled pots and pans.

### Beauty Of Choice

As much a design component as a high performance appliance, the black DishDrawer™ Dishwasher brings a touch of sophistication to your kitchen, on its own or part of a matching kitchen appliance set.

### True Half Load

Each drawer holds a true half load for small, fast dish washing that won't waste water. Both drawers operate independently so two wash cycles can operate simultaneously to allow for varying loads.

### Quiet Performer

Running at a very low decibel rating, these DishDrawer™ Dishwashers do their job without making a fuss. The combination of intelligent technology and simple mechanics means greater reliability and excellent wash performance.

## SPECIFICATIONS

### Accessories (included)

Cutlery basket	•
Kickstrip	<b>true</b>
Knife clip and multipurpose clip	•

### Capacity and loading

Accommodates round plates up to	<b>280mm</b>
Adjustable height, foldable cupracks	•
Fold down tines	•

Pitch adjustable tines	•
Place settings	14
Place settings	14
Place settings per drawer	7

**Consumption**

Energy rating	3.5 star
Energy usage	136kWh/year per drawer
In-use energy carbon emissions estimate	18.4kgCO2e/year per drawer
Water consumption (per wash cycle)	6.9L per drawer
Water rating	4.5 star (WELS)

**Controls**

End of cycle beeps	•
Energy saving delay start option of up to 12 hours	•
Internal wash selector	•
Keylock	•
Rinse aid indicator light	•
Smart appliance	•

**Features**

Fan assisted drying	•
Flood protection	•
Flow through detergent dispenser	•
Quiet operation	•
SmartDrive™ technology	•

**Performance**

Noise on standard cycle top drawer	42 dBA
------------------------------------	--------

**Power requirements**

Amperage	10A
Supply frequency	50Hz
Supply voltage	220 - 240V

**Product dimensions**

Depth	573 mm
Height	820 - 880 mm
Width	599 mm

**Warranty**

Parts and labour	2 years
------------------	---------

**Wash Program Modifiers**

Extra Dry	•
Quick	•
Sanitise	•
Wash modifiers	3

**Wash Programs**

Delicate	•
Eco	•
Fast	•

Heavy	•
Medium	•
Rinse	•
Wash programs	6

**Water connection**

Water pressure	30kPa - 1000 kPa
Water supply	3/4" BSP (20mm) Connector Water Inlet Hose

SKU	82326
-----	-------

The product dimensions and specifications in this page apply to the specific product and model. Under our policy of continuous improvement, these dimensions and specifications may change at any time. You should therefore check with Fisher & Paykel's Customer Care Centre to ensure this page correctly describes the model currently available. © Fisher & Paykel Appliances Ltd 2020

**Other product downloads available at fisherpaykel.com**

- [↓](#) Energy & Water Label DishDrawer™ Dishwasher
- [↓](#) Service & Warranty
- [↓](#) Installation Guide Double DishDrawer™ Dishwasher
- [↓](#) Installation Guide Double DishDrawer™ Dishwasher
- [↓](#) Installation Guide Double DishDrawer™ Dishwasher
- [↓](#) Quick Start Guide DishDrawer™ Dishwasher EN
- [↓](#) Revit Double DishDrawer™ Dishwasher
- [↓](#) Rhino Double DishDrawer™ Dishwasher
- [↓](#) Sketchup Double DishDrawer™ Dishwasher

- ↓ User Guide DishDrawer™ Dishwasher
- ↓ Wash Program Data ASNZS DishDrawer™ Dishwasher

**Where applicable:**

All appliances use energy, and energy usage typically generates carbon emissions. **Fisher & Paykel Appliances' In-use Energy Carbon Emissions Estimate** indicates carbon emissions from a product's in-use energy. This is calculated either annually or per cycle, using the product's market-specific energy label energy consumption data multiplied by the carbon emissions factor for energy in your country or region.

Our In-use Energy Carbon Emissions Estimate is designed to assist customers in making informed purchasing decisions when comparing different Fisher & Paykel products. For example, a heat pump dryer typically has a lower In-use Energy Carbon Emissions Estimate than a vented dryer.



**A PEACE OF MIND SALE**  
24 Hours 7 Days a Week Customer Support  
T 0800 372 273 W [www.fisherpaykel.com](http://www.fisherpaykel.com)