

Series 5, Contemporary Built-under Dishwasher

Series 5 | Contemporary

Stainless Steel



Designed to fit flush under your benchtop for a seamless look, this dishwasher delivers extra wash options and Auto Door Open Dry.

- Designed to be built under your benchtop, fitting flush with cabinetry for a seamless look
- Seven wash programs from Heavy to Light, including Auto, 60min and Eco
- Dry+, Sanitise and Half Load modifiers provide extra wash options

- Wi-Fi enabled and works with the SmartHQ™ app for remote control and notifications

DIMENSIONS

Height	820 - 880 mm
Width	597 mm
Depth	574 mm

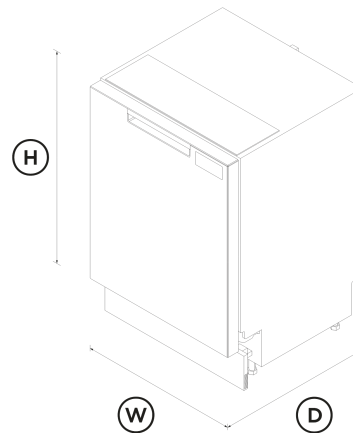

FEATURES & BENEFITS

Seamless Design

Install this dishwasher flush under your benchtop with minimal gaps. Designed to match Fisher & Paykel's Contemporary family of appliances for a seamless finish in your kitchen.

Effortless Drying

For beautifully dry dishes every time, this dishwasher features the Auto Door Open Dry function. This function automatically releases excess steam at the end of the cycle, ensuring dishes are immediately ready for use or storage. An innovative air curtain channels the steam away from the adjacent benchtop, protecting your cabinetry.

A Reliable Clean

This dishwasher offers seven wash programs including Auto, which automatically senses the optimal wash settings for your dishes. The three-stage filtration system delivers a superior clean, while the rinse aid indicator reminds you to top up for beautifully clean dishes.

Customise Your Wash

The Half Load modifier is perfect for washing a partial load, for faster turnaround of dishes. Sanitise provides extra protection, killing 99.9% of bacteria* in the final rinse, while the Dry+ modifier is great for plastic dishes.

*Certified to NSF/ANSI Standard 184

Efficient Performance

With a 4 star energy rating and 5 star water rating, this dishwasher delivers a powerful wash. Use the Eco wash program for optimal water and energy consumption, or choose when the cycle begins with Delay Start.

Flexible Loading

Designed to fit 15 place settings with ease, adjustable racks help you to load and care for various items - including a height-adjustable upper basket, and foldable cup holders and tines.

SPECIFICATIONS

Accessories (included)

Kickstrip true

Capacity and loading

Accommodates round plates up to (lower basket)	320mm
Accommodates round plates up to (top basket)	250mm
Adjustable height, foldable cupracks	•
Easy lift adjustable upper basket	•
Fold down tines	•
Place settings	15
Place settings	15

Consumption

Energy rating	4 star
Energy usage	246kWh/year
In-use energy carbon emissions estimate	160.2kgCO2e/year
Water consumption (per wash cycle)	12.2L
Water rating	5 star (WELS)

Controls

Energy saving delay start option of up to 12 hours	•
Intuitive capacitive touch controls	•
Keylock	•
Rinse aid indicator light	•
Smart appliance	•

Features

Air curtain for bench protection	•
Aquastop	•

Auto Door Open Dry	•
Flood protection	•
Half load option	•
Internal tub material	Stainless Steel
Motor type	Asynchronous
ThermoDry system	•
Three-stage filtration system	•

Performance

Noise emissions	46 dBA
-----------------	---------------

Power requirements

Amperage	10A
Supply frequency	50Hz
Supply voltage	220 - 240V

Product dimensions

Depth	574 mm
Height	820 - 880 mm
Width	597 mm

Warranty

Parts and labour	2 years
------------------	----------------

Wash Program Modifiers

Dry +	•
-------	---

Half load	•
Sanitise	•
Wash modifiers	3

Wash Programs

60 min	•
Auto	•
Eco	•
Heavy	•
Light	•
Medium	•
Rinse	•
Wash programs	7

Water connection

Water pressure	30kPa - 1000 kPa
Water supply	3/4" BSP (20mm) Connector Water Inlet Hose

SKU	82428
-----	--------------

The product dimensions and specifications in this page apply to the specific product and model. Under our policy of continuous improvement, these dimensions and specifications may change at any time. You should therefore check with Fisher & Paykel's Customer Care Centre to ensure this page correctly describes the model currently available. © Fisher & Paykel Appliances Ltd 2020

Other product downloads available at fisherpaykel.com

- [↓](#) 2D-DWG Dishwasher
- [↓](#) 2D-DXF Dishwasher
- [↓](#) Data Sheet Dishwasher
- [↓](#) Energy & Water Label Dishwasher
- [↓](#) Service & Warranty
- [↓](#) Installation Guide Built-Under Dishwasher
- [↓](#) User Guide Dishwasher
- [↓](#) Wash Program Data Dishwasher

Where applicable:

All appliances use energy, and energy usage typically generates carbon emissions. **Fisher & Paykel Appliances' In-use Energy Carbon Emissions Estimate** indicates carbon emissions from a product's in-use energy. This is calculated either annually or per cycle, using the product's market-specific energy label energy consumption data multiplied by the carbon emissions factor for energy in your country or region.

Our In-use Energy Carbon Emissions Estimate is designed to assist customers in making informed purchasing decisions when comparing different Fisher & Paykel products. For example, a heat pump dryer typically has a lower In-use Energy Carbon Emissions Estimate than a vented dryer.



A PEACE OF MIND SALE
24 Hours 7 Days a Week Customer Support
T 1300 650 590 **W**www.fisherpaykel.com