

FISHER & PAYKEL

**COOLDRAWER™
MULTI-TEMPERATURE DRAWER**

RB36S & RB90S models

**USER GUIDE
US CA NZ AU BI SG**

CONTENTS

Safety and warnings	5
Before you begin	8
Control panel	9
Food modes	10
ActiveSmart™ special features	12
Using your appliance	14
Cleaning care	18
Food care	20
User warnings and sounds	21
Troubleshooting	22
Service and Warranty	25
European Directive 2012/19/EU on Waste Electrical and Electronic Equipment (WEEE)	26

Registration

To register your product visit our website: fisherpaykel.com/register

SAFETY AND WARNINGS

WARNING!



Electric Shock Hazard

Failure to do so can result in death, electric shock, fire or injury to persons.

- Read and follow the safety and warnings outlined in this user guide before operating this appliance.

WARNING!



This appliance contains flammable refrigerant isobutane (R600a).

SAFETY AND WARNINGS

READ AND SAVE THIS GUIDE

WARNING!

Read entire manual. Failure to follow all guides and rules could cause personal injury or property damage. When using this appliance, always exercise basic safety precautions including the following:

General Use

- Children should be supervised to ensure that they do not play with the appliance.
- Cleaning and user maintenance shall not be made by children without supervision.
- This appliance can be used by children aged from 8 years and above and persons with reduced physical, sensory or mental capabilities or lack of experience and knowledge if they have been given supervision or instruction concerning use of the appliance in a safe way and understand the hazards involved.
- The manufacturer's installation instructions for product and cabinetry ventilation must be followed when installing the appliance.
- To avoid hazard due to instability of the appliance, it must be fixed in accordance with installation instructions.
- Keep ventilation openings, in the appliance enclosure or the built-in structure, clear of obstruction.
- Do not use mechanical devices or other means to accelerate the defrosting process, other than those recommended by the manufacturer.
- Do not damage the refrigerant circuit.
- In case of damage to the refrigerant circuit, ventilate the area by opening all windows. Do not operate electrical equipment or any other equipment that may produce arcs, sparks or flames in the area. Contact your Fisher & Paykel trained and supported service technician immediately to arrange for the appliance to be repaired.
- It is hazardous for anyone other than an authorized service person to service this appliance. In Queensland, the authorized service person must hold a gas work licence or authorisation for hydrocarbon refrigerants to carry out service or repairs which involve removal of covers.
- This refrigerating appliance is intended to be used at ambient temperatures ranging from 16°C to 43°C. The product performance may be compromised when operating outside of this temperature range.

WARNING!

- This product contains a chemical known to the State of California to cause cancer, birth defects or other reproductive harm. For more information on these regulations and a list of chemicals, visit: <https://oehha.ca.gov/proposition-65/general-info/proposition-65-plain-language>.

SAFETY AND WARNINGS

Electrical

- This appliance must be installed in accordance with the installation instructions before use.
- To allow disconnection of the appliance from the supply after installation, incorporate a switch in the fixed wiring in accordance with the local wiring rules.
- If the power supply cord is damaged, it must only be replaced by your Fisher & Paykel trained and supported service technician.
- **WARNING:** Do not use electrical appliances inside the food storage compartments of the appliance, unless they are of the type recommended by the manufacturer.

Servicing

- Your appliance is designed to operate for many years without the need for service checks. However, if your appliance is malfunctioning, have it attended to by your Fisher & Paykel trained and supported service technician as soon as possible.
- If you suspect that the product is not getting cold—items such as ice cream are melting, remove all perishable food and store in another appliance or cooler to prevent spoilage. Immediately call for a service technician.

Power failure

- Do not refreeze frozen foods that have thawed completely. The food may be dangerous to eat. Follow the recommendations below if you discover food in your freezer has thawed:
- Ice crystals still visible—food may be refrozen but should be stored for a shorter period than recommended.
- Thawed but refrigerator cold—refreezing generally not recommended. Fruits and some cooked food can be refrozen but use as soon as possible. Meat, fish, poultry—use immediately or cook then refreeze. Vegetables—discard as they usually go limp and soggy.
- Thawed and warmer than 41°F (5°C)—discard all food.

BEFORE YOU BEGIN

- The CoolDrawer™ allows you to adjust the storage space to meet your storage needs.
- Storage bins can be removed to provide open flexible storage space.
- Multi-level storage provides segregation of food items. The compact upper storage tray provides safe storage for delicate items or segregation for small items.

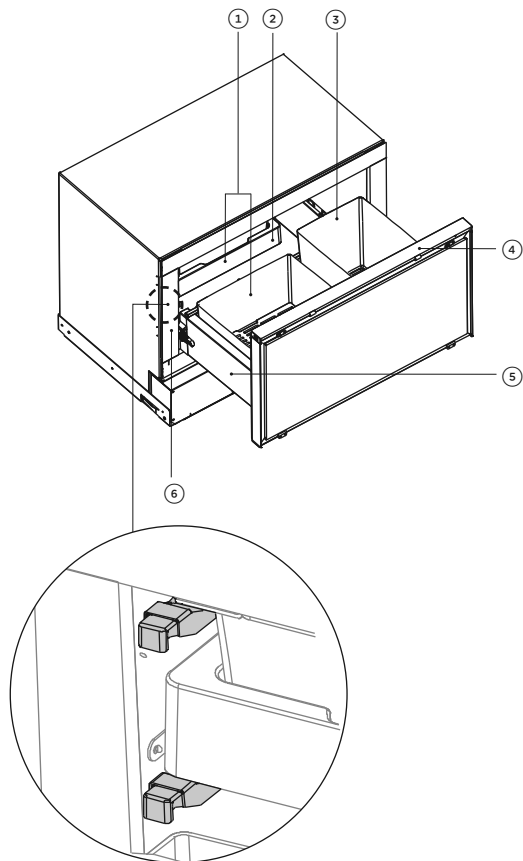



Cool Drawer features

- ① Storage bins featuring humidity control system
- ② Compact storage tray
- ③ Tall storage bin
- ④ Control panel
- ⑤ Main storage tray
- ⑥ Humidity control buttons

CONTROL PANEL

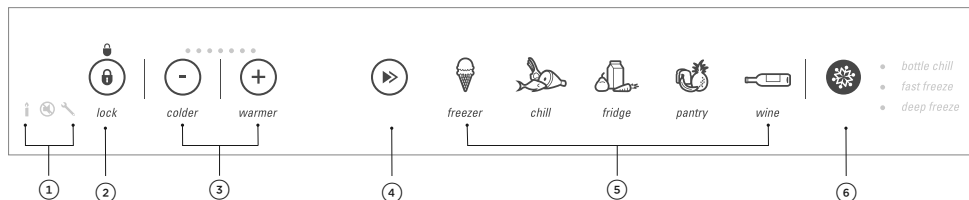
The control panel enables you to view and modify all the features and options of your drawer. When the appliance is first turned on, the default setting is 'freezer' mode. If you wish to use the appliance in another mode, simply select another food mode displayed on the control panel.



①  Illuminates to indicate that Sabbath mode is activated.

 Illuminates to indicate the key tones are muted.

 Illuminates to indicate there is a fault.

② Illuminates when the control panel is locked. Press for 2 seconds to lock/unlock the control panel.

③ Allows you to adjust the temperature. Each of the food modes will automatically default to an ideal temperature setting. The recommended temperature setting is always the center light.

④ Allows you to select the food mode for the CoolDrawer™.

⑤ The icons illuminate to show which food mode is selected.

⑥ Allows you to scroll and select features:

Press to scroll and select features, the light will illuminate next to the selected feature. These features can only be activated when the CoolDrawer™ is set to 'freezer' mode. Only one feature can be selected at a time.

- bottle chill
- fast freeze
- deep freeze

FOOD MODES

Variable temperature zones

Separate food modes allow you to adjust the temperature for optimal storage, depending on what foods you are storing.

FOOD MODES	DESCRIPTION	TYPES OF FOOD TO STORE
Freezer (-18°C/0°F)	Freezer mode is for general frozen food items that require storage between 1-12 months.	Meat, poultry, seafood, pre-cooked foods and leftovers, some fruit and vegetables, ice cream, and other frozen desserts.
Chill (-0.5°C/31°F)	Chill mode is an extension of fridge mode, providing the perfect storage zone for highly perishable food to ensure they retain their vital freshness and quality. These items will last slightly longer here compared with storage at fridge mode. Note: Ensure these highly perishable items are consumed within their recommended storage times.	Highly perishable meats, poultry and seafood. Alcoholic beverages such as beer.
Fridge (3°C/37°F)	The ideal mode for fresh, everyday foods. This mode offers a higher relative humidity than many other refrigerators allowing fresh foods such as fruits and vegetables, meats and cheeses to stay fresh for longer.	Fruit and vegetables, dairy products, jams and chutneys/preserves, meats and drinks.
Pantry (12°C/54°F)	Pantry mode provides a cool, dark place for a wide variety of foods that perish quickly or may spoil at room temperature, but are too sensitive to be stored at normal refrigerator temperatures. Pantry mode tested to Cellar Compartment storage conditions as per Commission Regulation (EU) 2019/2019.	Bananas, avocados, tomatoes. Dry food items such as grains, flours, sugars, crackers, cereal, baked goods and breads. Spreads, preserves, honey, tropical fruits, nuts and seeds, chocolate and fresh herbs.
Wine (12°C/54°F)	When wine mode is activated the default setting is longer-term storage (54°F/12°C). This mode operates between 45°F (7°C) to 59°F (15°C), providing an ideal controlled environment for the storage of wines.	Wine.

FOOD MODES

RECOMMENDED SERVING TEMPERATURES FOR DIFFERENT WINES

8°C (46°F)	Sparkling wines and sweet white wines	Vintage Champagne and Sparkling Wine, Riesling and Gewürztraminer
9°C (48°F)	Dry white wines	Sauvignon Blanc, Chenin Blanc, Bordeaux Blanc
10-12°C (50-54°F)	Dry white wines	Chardonnay and White Burgundy, Rosé
14-15°C (57-59°F)	Light to medium-bodied red wines	Young Bordeaux, Young Cabernet, Pinot Noir, Merlot

ACTIVESMART™ SPECIAL FEATURES

Bottle chill

This feature allows you to rapidly chill your beverages (Freezer mode) without the worry of forgetting about them. Activating 'bottle chill' drops the freezer down to its coldest setting for 15 minutes. After 15 minutes, an alarm will sound and the 'bottle chill' light will flash to remind you to remove your beverage.

Fast freeze

Boosts the freezing speed by dropping the freezer to its coldest temperature for a set time. This function can only be activated when the product is in Freezer mode. The duration is 12 hours.

Deep freeze

Activating deep freeze sets the freezer temperature to -13°F (-25°C). Deep Freeze is for frozen food items that may need to be stored for longer periods, extending the shelf life of general frozen items by up to 6 months longer than that of Freezer mode. This function can only be activated when the product is in Freezer mode.

Note: 'deep freeze' feature has no additional temperature adjustment. While 'deep freeze' is active no lights will be displayed on the temperature adjustment area.

Wine mode

This mode offers the ideal environment for both short and long-term wine storage for red or white wines. Temperature control is critical for the maturation of wines and wine mode ensures temperature fluctuations are low allowing wines to develop to their full potential.

With manual/independent adjustability choose a storage temperature from 45–59°F (7–15°C) to suit your personal needs. Some wines are best consumed at a young age, while others have remarkable ageing capabilities. Do check with your wine merchant for more information.

ACTIVESMART™ SPECIAL FEATURES

Fruit and vegetable storage

- The top and bottom bins on the left-hand side of the drawer are fitted with a Humidity Control Lid that creates a humid microclimate to ensure optimum fruit and vegetable storage.
- The Humidity Control Lid functions to prevent condensation from dripping onto the fruit and vegetables below by retaining the moisture into the specially designed grooves.

Select the appropriate humidity control button depending on what is stored in the bins. The humidity controls are located on the left-hand side of the CoolDrawer™.

To adjust the humidity setting:

The picture on the top of the humidity control button will show the current setting. To change the setting, simply push the adjustment button.



Suitable for salad greens such as:

Lettuce
Spinach
Broccoli
Cabbage
Carrots



Suitable for fruit with skin/peel such as:

Oranges
Lemons
Limes
Apples
Pears
Kiwifruit

Store fruits and vegetables in separate bins if possible and without external packaging. Separating these will prevent ethylene-sensitive produce from ripening too quickly and help extend their storage life.

If there is too much water in the bins (due to high humidity) the control can be adjusted to the  setting. Wipe dry if required remembering that a small amount of condensation in the bins is beneficial for optimum storage.

USING YOUR APPLIANCE

Before placing food in the drawer

- Clean the inside of the appliance with warm water and a little liquid detergent to remove manufacturing and transportation dust.
- Ideally, allow the drawer to run empty overnight, or for at least 5 hours, to allow it to cool to the appropriate temperature before placing food inside.
- The appliance may have an odor initially, but this will go when the compartment has cooled sufficiently.

Energy efficiency

For the most energy efficient use of your appliance:

- Ensure your CoolDrawer™ has adequate ventilation as recommended in the installation instructions.
- Allow good clearances in front of air ducts within the CoolDrawer™.
- Cool hot foods down before placing them in the CoolDrawer™.
- Do not overfill the CoolDrawer™.
- Keep door openings to a minimum.
- Select a temperature setting that isn't too cold.



If your appliance is turned off for any reason, wait 10 minutes before turning it back on. This will allow the refrigeration system pressures to equalize before restarting.

The temperature of the drawer is accurately controlled and does not change with the temperature or humidity of the surroundings; whether summer or winter.

For best storage of general household food items, we recommend to use the appliance at its factory default temperature and configuration settings. Adjusting temperature and moving the shelves and bins will have minimal impact on efficiency.

To use the control panel



Unlock the control panel, press  for 3 seconds. The  icon will no longer be illuminated.

Match the type of items you wish to store in the CoolDrawer™ to the relevant storage environment.



Press  to scroll through the available **FOOD MODE**.

A light illuminates to indicate the matching **FOOD MODE** as you scroll the list.

The food mode icon selected will flash until the CoolDrawer™ reaches a suitable temperature for food to be added (this will take approximately 1-6 hours).

USING YOUR APPLIANCE

►► Selecting the Food Mode



Select the desired compartment.



Press ►► to scroll through the available **FOOD MODE**.

A light illuminates to indicate the matching **FOOD MODE** as you scroll the list.

Adjusting the temperature

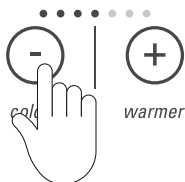

Press **-** once to reduce the temperature. This will decrease the number of lights. When all four lights on the left are showing, the coldest setting is selected.

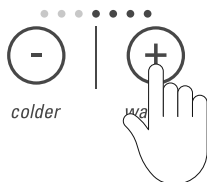

Press **+** once to increase the temperature. This will increase the number of lights. When all four lights on the right are showing, the warmest setting is selected.

USING YOUR APPLIANCE

❄️ Selecting features



Pressing ❄️ will scroll through the available features for the 'freezer' mode. A blinking light indicates the current position when scrolling through the list.

To activate:

Select the feature from the list, by scrolling through and stopping at the feature you wish to use.

Press ❄️ for 4 seconds..

🗄️ Bottle Chill



This feature allows you to rapidly chill your beverages in the freezer without the worry of forgetting about them. An alarm will sound and the 'bottle chill' light will illuminate after 15 minutes to remind you to remove your beverage. Remember to remove your beverage when the alarm sounds, to ensure the liquid does not freeze.

To silence the alarm::

- The user alarm will continue to sound until the drawer is opened and the control panel is unlocked.
- The time taken to chill depends on the size of your beverage. If your beverage is not cold enough after the set time, return it to the compartment and reset the bottle chill feature.

🕛 Sabbath mode

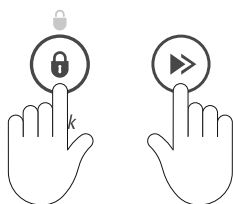

Press 🔒 for 3 seconds to unlock the control panel.

To activate/deactivate:

Press 🔒 and ➡️ together for 4 seconds, the 🕛 will be illuminated when the function is activated.

When activated—the display, all alarms and lights are deactivated for 80 hours.

USING YOUR APPLIANCE

Drawer alarm

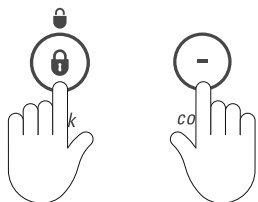

- If the drawer is left open an alarm will sound after 60 seconds.
- If the drawer remains open, subsequent beeps will sound every 30 seconds until the drawer is closed.
- After 5 minutes of the drawer being opened, the alarm will sound continuously and the compartment light will turn off.

Key mute



To activate:

To activate key mute, press  for 3 seconds to unlock the control panel.

Press  and  for 4 seconds, the  icon will be illuminated when the function is activated.



Key lock

The control panel will automatically lock when inactive for more than 15 seconds or when the drawer is closed.



To activate/deactivate:

Press  for three seconds.

When the panel is locked, the lock  icon will appear above the .

CLEANING CARE

Do not use harsh chemicals, abrasives, ammonia, chlorine, bleach, concentrated detergents, solvents or abrasive scouring pads on any part of your appliance. Some of these chemicals may damage your appliance.

Clean all surfaces with a mild liquid detergent dissolved in warm water and a soft cloth. Rinse with clean water and dry with a clean, lint free cloth.

Interior

- It is important to keep the interior of the drawer clean to help prevent food from becoming contaminated during storage. The amount and types of food stored determines how often cleaning should be carried out (ideally once every 1 to 2 weeks).
- For ease of cleaning, remove the storage bins from the drawer.
- The main storage tray can also be removed for cleaning. To remove the tray, slide the clips located on the back sides of the tray, into the center of the tray. Ensure the clips are pushed back to the sides once the tray is placed back into the drawer.
- Wipe the control panel with a soft, damp, lint-free cloth.
- To help remove any 'old stale refrigerator' smells add a few drops of vanilla essence or vinegar to the water before cleaning.

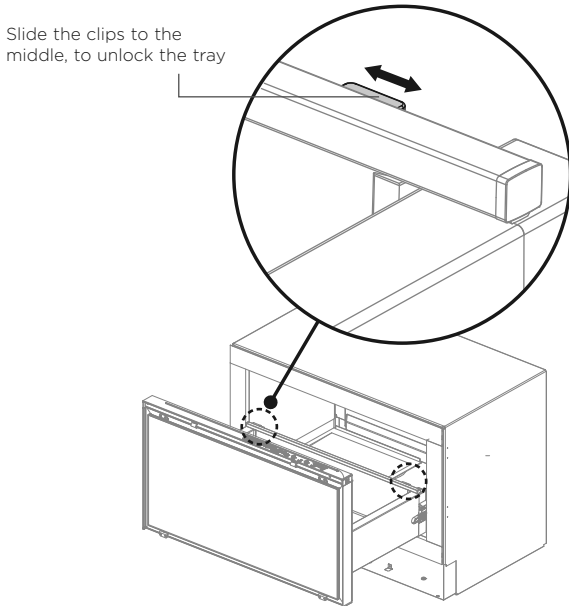

Removal of storage tray

CLEANING CARE

Exterior

Door gasket

- We recommend cleaning the magnetic door gasket every three months with an old toothbrush, and liquid dishwashing detergent dissolved in warm water.
- Gasket must be kept clean and pliable to ensure a proper seal.

Air inlet duct

- To maximize operating efficiency keep ventilation openings clear of obstructions by regularly vacuuming the flooring in front of your appliance.
- We recommend cleaning the air inlet duct at least once every 6 months with a vacuum cleaner. This is located on the bottom, left hand side of the appliance (accessed from the toe kick area).
- More frequent cleaning may be necessary for dusty homes or those with pets shedding hair.

Holiday/Vacation time

We recommend you leave your appliance operating while you are on holiday. Remove all perishable food from the drawer.

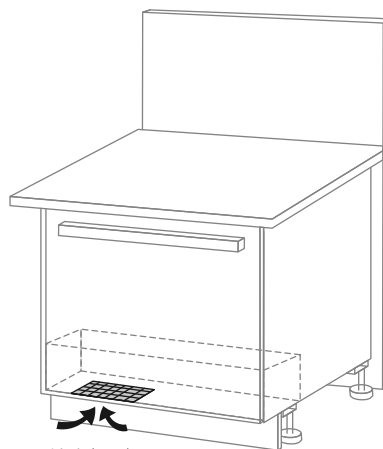

FOOD CARE

For best food care

- Store only high quality, fresh food in your CoolDrawer™.
- Store perishable foods in the CoolDrawer™ immediately after purchase. Storing at room temperature increases the rate of deterioration and can allow harmful microbial growth.
- Foods such as meat, poultry and seafood should be well wrapped or sealed in suitable packaging to prevent dehydration, color deterioration, loss of flavor, and transfer of odor. Note: We recommend storing these foods on the bottom shelf of your CoolDrawer™ or in one of the bins to prevent potential spills and cross contamination with other foods.
- Ensure hot foods and beverages are cooled sufficiently before placing them into the CoolDrawer™. Hot items may cause other foods to warm to unsafe temperatures. It may also cause sealed items to sweat/condensate which is undesirable.
- Beverages are best stored standing upright in the door shelves or on the bottle racks provided.
- Ensure raw and cooked foods are stored separately to avoid cross contamination.
- Consume food items within the recommended storage times. Discard foods that show sign of spoilage.
- Keep door openings to a minimum to maintain optimum storage temperatures inside your appliance.
- We recommend using 'fast freeze' when you are adding food items to your CoolDrawer™, such as after grocery shopping. This feature will ensure the food is chilled/frozen within the shortest period of time, locking in the freshness and extending the shelf life of your food.
- Storing at temperatures other than settings recommended may impact the storage life.
- For common foodstuffs, factory default setting (mid-mid) provides the optimum setting for foodcare.

Items stored in fridge/chill mode

- Dairy items such as butter and cheeses should be stored in the covered containers to minimize any transfer of odor or odor absorption with other foods.
- Eggs should be stored in their carton to avoid absorption of strong odors through their porous shell structure.
- Do not store chill sensitive items such as fruits and vegetables in a compartment when it is set to Chill mode. Cold temperatures may result in damage such as chill or freezing injury.

When in freezer mode

- We recommend cooling carbonated beverages only when the 'bottle chill' function is active.
- Note: Do not store carbonated drinks without this function in the freezer, failure to remove beverages could lead to freezing liquid and the likelihood of bottle/can explosion.
- Ensure air is removed from packaging to avoid large formation of ice crystals and prevent freezer burn.
- To maintain freshness and quality, we recommend defrosting foods in the refrigerator, these foods should not be in contact with fresh foods. Ensure partially or fully defrosted foods are never re-frozen – cook immediately.
- Defrosting food repeatedly is not recommended. Frozen foods that will be used regularly should be stored in smaller quantities.

USER WARNINGS AND SOUNDS

Faults

In the unlikely event a fault occurs the  icon will illuminate on the control panel and an alarm will sound.

- If such a fault occurs, please contact our Customer Care Center immediately.
- To silence the fault alarm press any button on the control panel. The  icon will remain illuminated until the fault is corrected.

Normal appliance sounds





The CoolDrawer™ with its excellent energy ratings and cooling performance, can produce sounds that may be different to your old refrigerator.

WARNING/ SOUND	DESCRIPTION
Fan air flow	The CoolDrawer™ has a fan which circulates air around the drawer to provide cooling. This produces some air flow sound. This is quite normal. The CoolDrawer™ also has a condenser fan to discharge heat through the condenser. This also produces some airflow sound. This is normal.
Cracking or popping	This occurs when the defrost function is operating.
Running water	This is the liquid refrigerant in the system, and can be heard as a boiling or gurgling noise.
Hissing sound after closing the freezer door	This is due to the pressure difference between the warm air that has entered the drawer and suddenly cooled, and the outside air pressure.
Humming	This is normal as the motor operates for long periods of time. This appliance uses an energy efficient, variable speed compressor that saves energy by running for long periods of time on a low speed. This is more energy efficient than the conventional on/off method.
Other sounds	Floor or cabinetry uneven or weak. Bottles or jars rattling. Appliance not installed correctly.

TROUBLESHOOTING

If there is a problem with your appliance, please check the following points before contacting your local Fisher & Paykel trained and support service technician or the Customer Care Center.

Product parts and accessories can be purchased through Fisher & Paykel Customer Care Center or online at fisherpaykel.com (this service is available to selected markets only).

PROBLEM	POSSIBLE CAUSES	WHAT TO DO
Appliance does not operate	No electricity at power outlet.	Check that the plug is correctly connected to outlet and that power is switched on. Check another appliance at the same outlet. Check the house fuse.
	Power cord not attached at the rear of appliance.	Has the appliance just been installed? Refer to your Installation instructions sheet to ensure the installer signed saying the product was working after installation then call your Fisher & Paykel trained and support service technician.
Interior light and/or control panel not working	No electricity at power outlet.	Check that appliance is connected to power and is switched on.
	Sabbath mode may be activated.	Press  and  together for four seconds, until  icon disappears.
	Light not functioning.	The light cannot be serviced by the user. Contact your Fisher & Paykel trained and supported service technician.
	Key Lock mode may be activated.	Press  for 3 seconds until the  icon light goes out.
Motor operates for long periods	Note: This is normal. This appliance uses an energy efficient variable speed compressor that saves energy by running for long periods of time on a low speed. This is more energy efficient than the conventional on/off method.	
Unfamiliar noises coming from appliance	Freezer is defrosting.	This is normal.
	Refrigerant noises, eg cracking, popping, hissing, running water, humming.	This is normal. Refer to 'User warnings and sounds'.
Slides not extending fully		Hold onto sides of drawer or tray, extend the slides fully and evenly by using a firm pull on both sides. This will reset the slides.
Drawer panel not sitting flush with cabinetry	Drawer skin not fitted or adjusted correctly.	Adjust drawer skin. Refer to your Installation instructions sheet.

TROUBLESHOOTING

PROBLEM	POSSIBLE CAUSES	WHAT TO DO
Condensation inside the drawer	Frequent or long drawer openings.	Minimize drawer openings.
	Drawer not sealing or closing properly.	Move items around so drawer can close tightly. Check that seal is sitting flat and sealing tightly.
		Check that drawer skin is not clashing with surrounding cabinetry.
	High humidity environment.	May occur during periods of high humidity. Wipe dry.
Drawer hard to open or close. Tray or bin hard to pull out	Appliance may not be level.	Refer to your Installation instructions sheet.
	Slides not extending fully.	Hold onto sides of drawer or tray, extend the slides fully and evenly by using a firm pull on both sides. This will reset the slides.
	Food or packaging trapped.	Move items around so drawer can close tightly.
	Drawer not sealing or closing properly.	Check that seal is sitting flat and sealing tightly.
	Note: When drawer is set to 'freezer' mode slides will not move as freely compared to other modes selected due to the lower temperatures.	
Storage area too warm or too cold	Temperature setting not correct.	Refer to 'Adjusting the temperature'.
	Frequent drawer openings.	Minimize drawer openings to allow temperature to stabilize.
	Warm, humid weather.	Minimize drawer openings to allow temperature to stabilize.
	Drawer not sealing or closing properly.	Move items around so drawer can close tightly, and seal is sitting flat when closed. Check that drawer panel is not clashing with surrounding cabinetry.
	Large amount of food recently added.	Minimize drawer openings to allow temperature to stabilize.
	The food mode of the drawer has recently been changed.	Wait for the food mode icon on control panel to stop flashing and recheck temperature.
	Note: When drawer is set to 'freezer' mode slides will not move as freely compared to other modes selected due to the lower temperatures.	
Food freezing when set to 'fridge' mode	Temperature setting not correct.	Refer to 'Adjusting the temperature'.
	Food placed directly in front of air outlets.	Move chill sensitive foods away from the back wall of the appliance.

TROUBLESHOOTING

PROBLEM	POSSIBLE CAUSES	WHAT TO DO
Food freezing when set to 'chill' mode	Temperature setting not correct.	Refer to 'Adjusting the temperature'.
	Items with high water content may freeze.	Select 'fridge' food mode.
Ice buildup inside freezer compartment	Drawer not sealing correctly.	Move items around so drawer can close tightly, and seal is sitting flat when closed.
	Frequent drawer openings.	Minimize drawer openings.
	High humidity environment.	Not unusual during periods of high humidity. Wipe out.
Small amount of frost located inside the bottom left-hand side of the compartment	Note: This is normal.	
Water in the storage bins	Condensation is formed from the water vapor produced by fruit and vegetables.	A small amount of condensation is beneficial for fruit and vegetable storage. If there is too much water wipe dry, and set humidity control button to fruit setting  , or store fruit and vegetables loosely wrapped in plastic bags.
Odor coming from appliance	Initial 'new' smell from manufacturing.	This is normal and will disappear once the drawer is in operation.
	Strong smelling food that have not been covered or contained.	Cover all strong smelling and odorous foods with food wrap or place food into sealed containers. Wipe drawer out with a mix of water and vanilla essence to reduce residual odor.
	Expired food.	Discard old food from the drawer. If in doubt, throw it out.
	Spills.	Clean up all spills as soon as they occur. Clean drawer with a mix of warm water and liquid dishwashing detergent. If a spill has escaped from large bottom tray and into the drawer, mop up as much of the spill as you can. If odor persists call your Fisher & Paykel trained and supported service technician.

SERVICE AND WARRANTY

For details of your manufacturer's warranty and contacts for servicing, refer to your separate 'Service and Warranty' book provided with your refrigerator.

This product has been designed for use in a normal domestic (residential environment). This product is not designed for any commercial use. Any commercial use by the customer will affect this products manufacturer's warranty.

For spare parts, please contact Fisher & Paykel Customer Care. Spare parts are available for all Fisher & Paykel refrigerators for a minimum period of 10 years from the date of manufacture.

Complete and keep for safe reference:

Model _____

Serial No. _____

Purchase Date _____

Purchaser _____

Dealer _____

City _____

State _____

Zip _____

Country _____

EUROPEAN DIRECTIVE 2012/19/EU ON WASTE ELECTRICAL AND ELECTRONIC EQUIPMENT (WEEE)

EU This appliance is marked according to the European directive 2012/19/EU on Waste Electrical and Electronic Equipment (WEEE). By ensuring this product is disposed of correctly, you will help prevent potential negative consequences for the environment and human health, which could otherwise be caused by inappropriate handling of this product.

The symbol  marked on the serial plate, or on the documents accompanying the product, indicates that this appliance cannot be treated as household waste. It shall be handed over to the applicable collection point for the recycling of electrical and electronic equipment. Disposal of the appliance shall be carried out in accordance with the local environment regulations for waste disposal and ensure the refrigerant circuit is not damaged.

For more detailed information about treatment, recovery and recycling of this product, contact your local city office, your household waste disposal service or your Fisher & Paykel retailer/dealer from whom you purchased this product.

FISHERPAYKEL.COM

© Fisher & Paykel Appliances 2021. All rights reserved.

The models shown in this guide may not be available in all markets
and are subject to change at any time.

The product specifications in this guide apply to the specific products and
models described at the date of issue. Under our policy of continuous product
improvement, these specifications may change at any time.

For current details about model and specification availability in your country,
please go to our website or contact your local Fisher & Paykel dealer.

849338C 10.21