

# FISHER & PAYKEL

## BOX WALL RANGEHOOD

---

CONTEMPORARY

HC24DCXB4, HC30DCXB4 & HC36DCXB4 models

INSTALLATION GUIDE

US CA

**⚠ WARNING!**



**Electric Shock Hazard**

**Failure to follow this advice may result in electric shock or death.**

- Installation and electrical wiring must be completed by qualified person(s) in accordance with all applicable codes and standards, including fire-rated construction.
- Always disconnect the appliance from the mains power supply before carrying out any maintenance or repairs.
- Improper grounding can result in a risk of electric shock

**⚠ WARNING!**



**Weight Hazard**

**Failure to follow this advice may result in damage or personal injury.**

- The appliance is heavy. Please ensure adequate care is taken when installing the appliance.
- The appliance must be installed onto a solid wall, stud, beam or truss.
- **Product weight:** HC24: 33lb (15kg), HC30: 35lb (16kg), HC36: 40lb (18kg).

**⚠ WARNING!**



**Cut Hazard**

**Failure to use caution could result in injury.**

- Take care: some edges are sharp.
- Wear gloves to protect against sharp edges.

**⚠ WARNING!**



**Fire Hazard**

**Failure to follow this advice may result in serious burns or death.**

- Never leave surface units unattended at high settings. Boilovers cause smoking and greasy spillovers that may ignite. Heat oils slowly on low or medium settings.
- Always turn hood ON when cooking at high heat or when flambéing food.
- Clean ventilating fans frequently. Grease should not be allowed to accumulate on fan or filter.
- Use proper pan size. Always use cookware appropriate for the size of the surface element.

**READ AND SAVE THESE INSTRUCTIONS**

**WARNING!**

**When using this appliance always exercise basic safety precautions including the following:**

**Installation**

- Please read the entire set of instructions before installing or using this appliance.
- Please make this information available to the person installing the appliance - doing so could reduce your installation costs.
- Always switch the power off prior to installation, servicing or cleaning of the appliance.
- This appliance must be installed and connected to the mains power supply only by a suitably qualified person according to these installation instructions and in compliance with any applicable local building and electricity regulations. Failure to install the appliance correctly could invalidate any warranty or liability claims.
- Ducting accessories are not supplied. All ducting must comply with local requirements and building codes.
- Attention should be given to ensure that any applicable regulations concerning the discharge of exhaust air are fulfilled.
- Before connecting any pipes, consult municipal ordinances to ensure that any applicable regulations concerning the discharge of exhaust air are adhered to and request permission from the person in charge of the building.
- Exhaust air must not be discharged into an existing flue that is used for exhausting fumes from appliances burning gas or other fuels.
- There shall be adequate ventilation of the room when the rangehood is used at the same time as appliances burning gas or other fuels.
- The minimum distance between the supporting surface for cooking vessels on the cooktop and the lowest part of the rangehood shall be 24" (610mm).

## SAFETY AND WARNINGS

---

- Stainless steel is very easily damaged during installation if abraded or knocked by tools. It is recommended to protect the top of the rangehood with cardboard or polystyrene during the installation to minimise the risk of damage occurring.
- To reduce the risk of damage occurring to the cooktop, it is recommended that the surface of the cooktop is protected with cardboard or a similar object during installation of the rangehood.
- This appliance is not intended for use by persons (including children) with reduced physical, sensory or mental capabilities, or lack of experience and knowledge, unless they have been given supervision or instruction concerning the use of the appliance by a person responsible for their safety.
- Children should be supervised to ensure they do not play with the appliance. Cleaning and user maintenance shall not be made by children without supervision.
- You must read the details concerning the method and frequency of cleaning.
- There is a fire risk if cleaning is not carried out in accordance with the instructions.
- Never leave frying food unattended since grease can overheat and catch fire. The risk of fire is even greater in the case of used oil.
- Do not flambé under the rangehood.
- Never use the rangehood without the filters in place.
- During an electrostatic discharge (ESD) it is possible that the device will stop working. By switching the device off and on the device will again work as intended.
- CAUTION: accessible parts may become hot when used with cooking appliances.
- Remove all packaging, including protective wrappings, before use.
- WARNING - TO REDUCE THE RISK OF INJURY TO PERSONS IN THE EVENT OF A RANGE TOP GREASE FIRE, OBSERVE THE FOLLOWING:
  - SMOTHER FLAMES with a close-fitting lid, cookie sheet, or metal tray, then turn off the burner. BE CAREFUL TO PREVENT BURNS. If the flames do not go out immediately, EVACUATE AND CALL THE FIRE DEPARTMENT.
  - NEVER PICK UP A FLAMING PAN - You may be burned.
  - DO NOT USE WATER, including wet dishcloths or towels - a violent steam explosion will result.
  - Use an extinguisher ONLY if:
    - You know you have a Class ABC extinguisher, and you already know how to operate it.
    - The fire is small and contained in the area where it started.
    - The fire department is being called.
    - You can fight the fire with your back to an exit.

## COMPONENTS REQUIRED

### PARTS

- Keep all packing materials until the unit has been inspected.
- Inspect the product to ensure there is no shipping damage. If any damage is detected contact the dealer or retailer you bought the product from to report the damage.
- Fisher & Paykel is not responsible for shipping damage.

#### Supplied

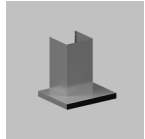

Rangehood (1)

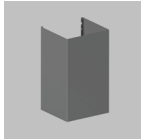

Chimney (1)



Upper chimney (1)

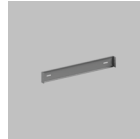

Upper chimney bracket (1)



Chimney bracket (1)

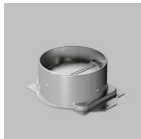

6" (150mm) diameter ducting adapter (1)

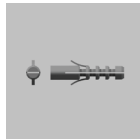

Expansion plug (8)

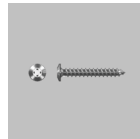

1 3/16" (30mm) Phillips screw (8)



3/8" (10mm) self tapping screw (2)

#### Not supplied

#### Recirculation Installation only



793602 Carbon filter (2)

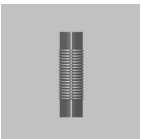

Ducting 6" (150mm) (1)\*

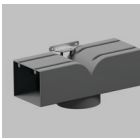

792580 Recirculation diverter kit (1)

\*Additional lengths can be ordered from [www.fisherpaykel.com](http://www.fisherpaykel.com).

### PARTS

#### Not supplied



33 7/16" (850mm) chimney extension  
792492: HC24 & HC36 models  
793834: HC30 models

#### Duct out installation only

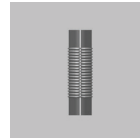

Metal 6" Ø150mm ducting (1)\*



Duct outlet (Soffit, wall, roof) (1)

### TOOLS

#### Not supplied

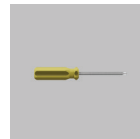

Phillips screwdriver (1)



Duct tape (1)

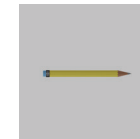

Pencil (1)



Ruler (1)



Electric drill (1)



Jigsaw (1)



Tape measure (1)

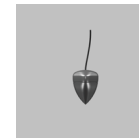

String & weight (1)



Level (1)

\*length dependant on installation

# PRODUCT DIMENSIONS | HC24DCXB4

DATUM: REAR OF PRODUCT

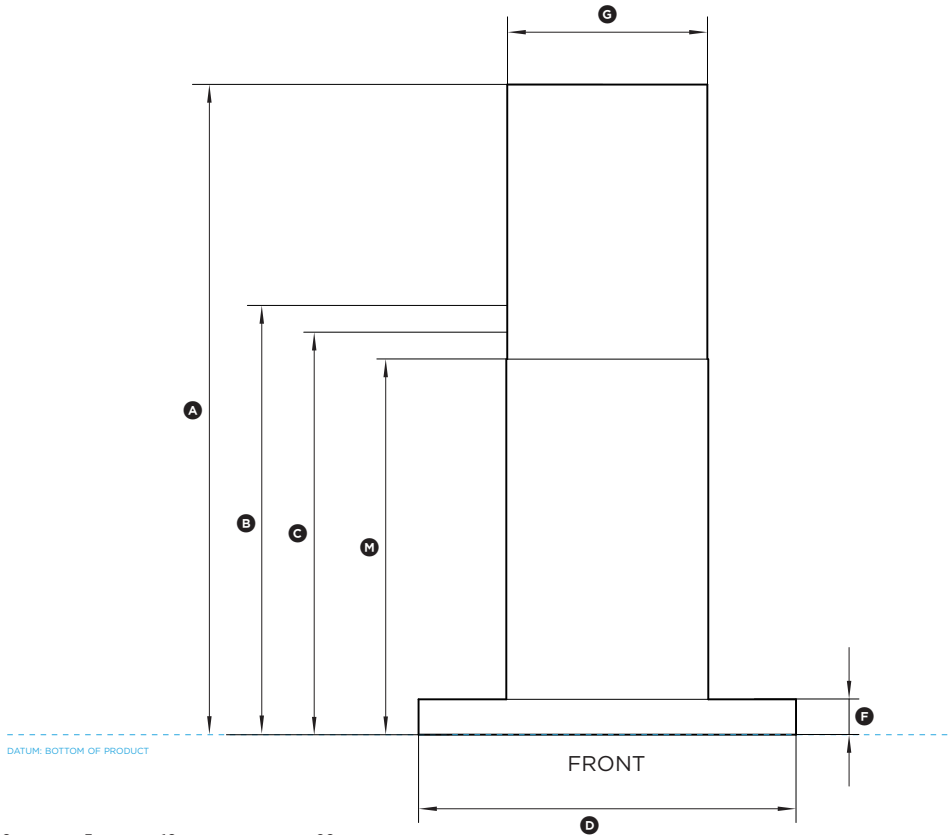
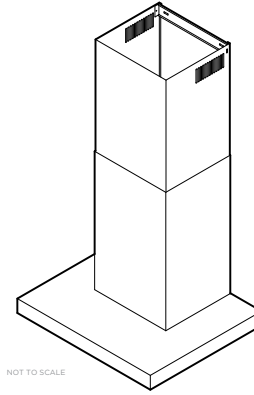
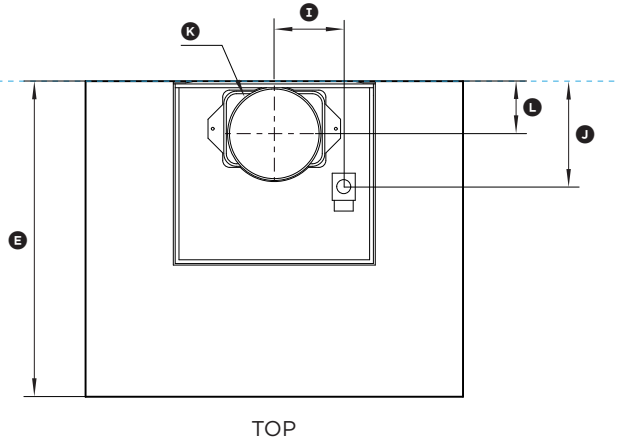

DATUM: REAR OF PRODUCT

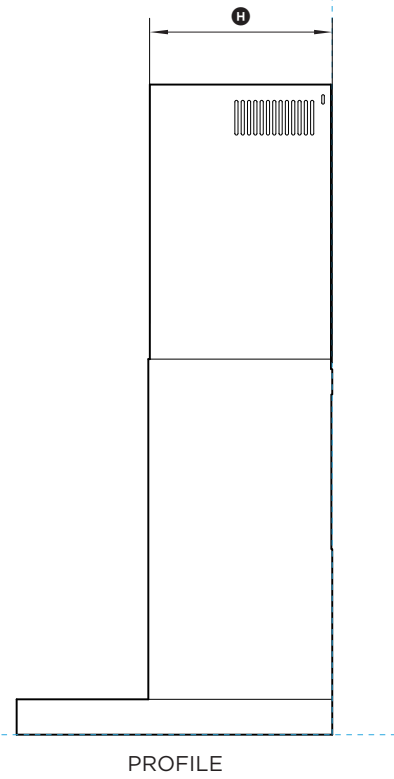

DATUM: BOTTOM OF PRODUCT

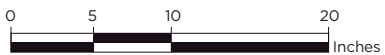

Product Dimensions	In	mm
(A) Maximum height of rangehood*	40 3/4"	1035
(B) Minimum overall height - recirculating	26 9/16"	675
(C) Minimum overall height	25"	635
(D) Overall width of rangehood	23 9/16"	598
(E) Overall depth of rangehood	19 11/16"	500
(F) Height of canopy	2 3/16"	55
(G) Width of chimney	12 5/8"	320
(H) Depth of chimney	11 7/16"	290
(I) Distance from centre plane to hard wiring box centre	5 1/16"	129
(J) Distance from back of product to centre of wiring box	6"	150
(K) Ducting outlet diameter	6"	150
(L) Distance from centre of ducting outlet to back of product	3 3/8"	85
(M) Height of datum to top of lower chimney section	23 7/16"	595

\* Maximum height with chimney extension accessories 55 1/8" (1400mm)

Minimum distance above cooktops	In	mm
Height from base of product to cooking surface	min 24"	610

Note: Minimum installation height may be greater if required by your cooktop. Refer to cooktop installation instructions.

INDICATES PRODUCT DATUM

INDICATES CABINETY CLEARANCES

Dimensions may vary by 1/16" (±2mm).

# PRODUCT DIMENSIONS | HC24DCXB4

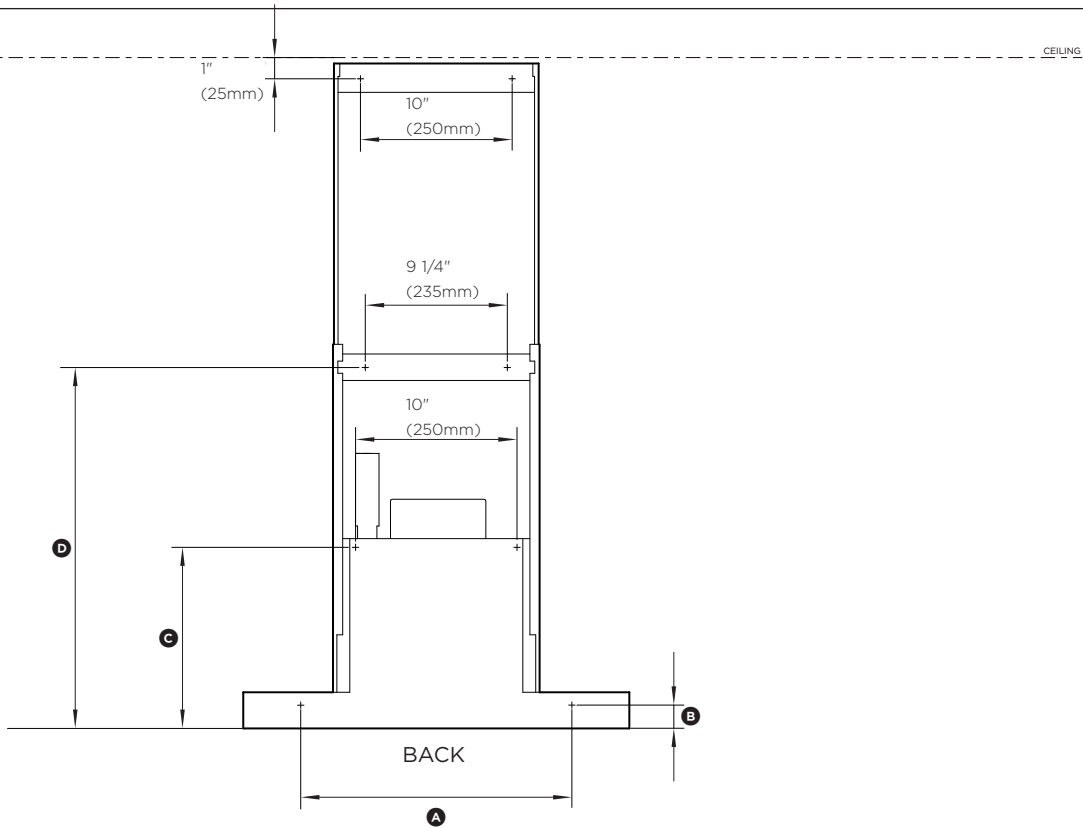

Product Dimensions	In	mm
Ⓐ Lower rangehood attachment point width	16 9/16"	420
Ⓑ Lower rangehood attachment point height	1 7/16"	36
Ⓒ Upper rangehood attachment point height	11 1/4"	286
Ⓓ Chimney bracket attachment point height	22"	558
Ⓔ Light length	16 3/4"	425
Ⓕ Distance from centre of light to front of product	2 3/8"	60

DATUM: REAR OF PRODUCT

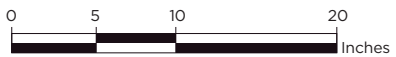
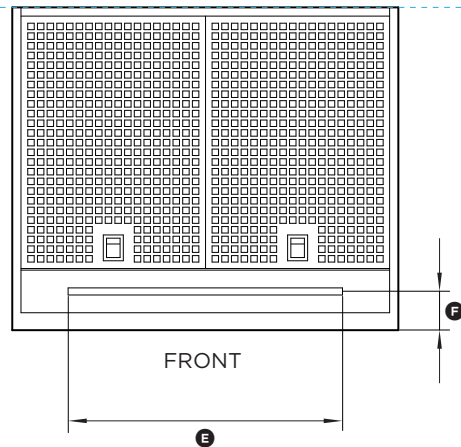

INDICATES PRODUCT DATUM

INDICATES CABINETY CLEARANCES

Dimensions may vary by 1/16" (±2mm).

# PRODUCT DIMENSIONS | HC30DCXB4

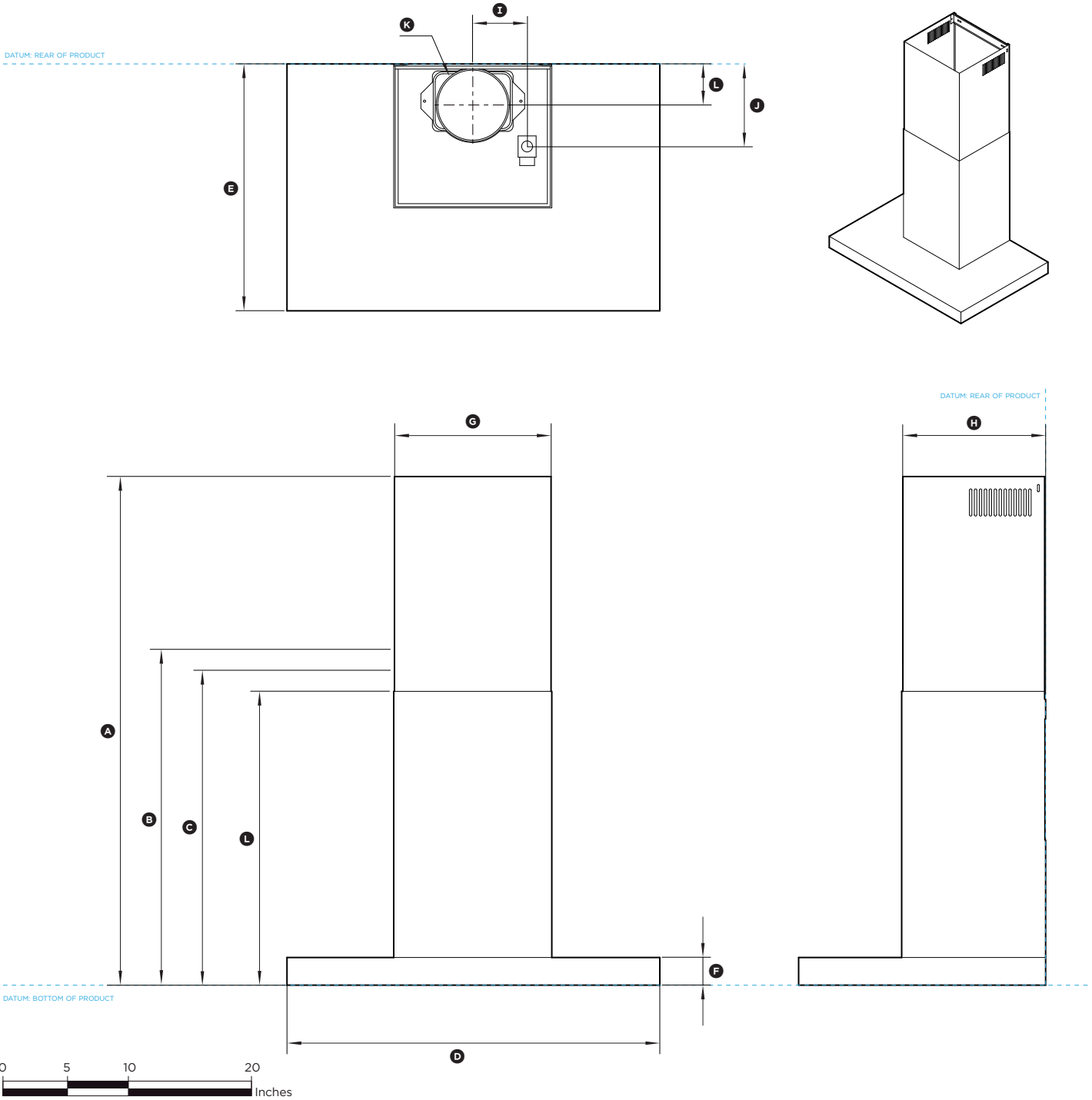

Product Dimensions	In	mm
Ⓐ Maximum height of rangehood*	40 3/4"	1035
Ⓑ Minimum overall height - recirculating	26 9/16"	675
Ⓒ Minimum overall height	25"	635
Ⓓ Overall width of rangehood	29 3/4"	755
Ⓔ Overall depth of rangehood	19 11/16"	500
Ⓕ Height of canopy	2 3/16"	55
Ⓖ Width of chimney	12 5/8"	320
Ⓗ Depth of chimney	11 7/16"	290
Ⓜ Distance from centre plane to hard wiring box centre	4 5/16"	110
Ⓨ Distance from back of product to centre of wiring box	6 9/16"	166
Ⓧ Ducting outlet diameter	6"	150
Ⓦ Distance from centre of ducting outlet to back of product	3 1/4"	82
Ⓩ Height of datum to top of lower chimney section	23 7/16"	595

\* Maximum height with chimney extension accessories 55 1/8" (1400mm)

Minimum distance above cooktops	In	mm
Height from base of product to cooking surface	min 24"	min 610

Note: Minimum installation height may be greater if required by your cooktop. Refer to cooktop installation instructions.

INDICATES PRODUCT DATUM -----  
INDICATES CABINETY CLEARANCES -----

Dimensions may vary by 1/16" (±2mm).

# PRODUCT DIMENSIONS | HC30DCXB4

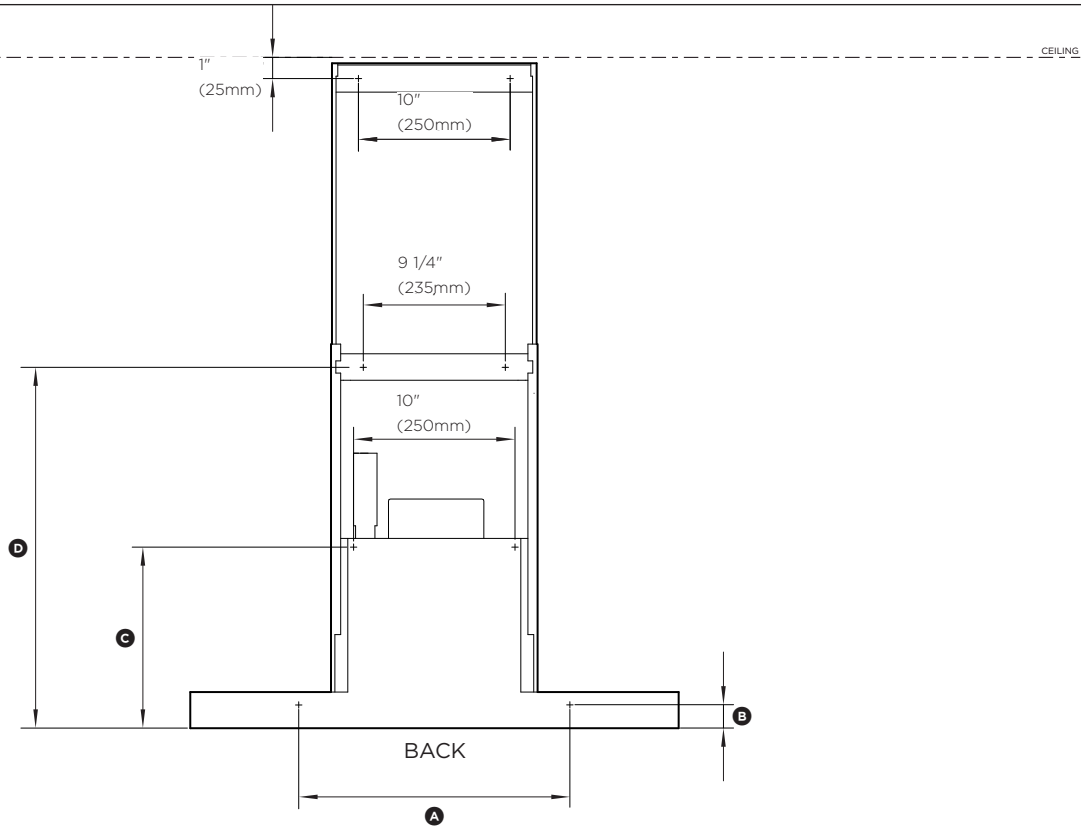

Product Dimensions	In	mm
Ⓐ Lower rangehood attachment point width	19 5/16"	490
Ⓑ Lower rangehood attachment point height	1 7/16"	36
Ⓒ Upper rangehood attachment point height	11 5/16"	288
Ⓓ Chimney bracket attachment point height	22 3/16"	564
Ⓔ Light length	16 3/4"	425
Ⓕ Distance from centre of light to front of product	2 3/16"	55

DATUM: REAR OF PRODUCT

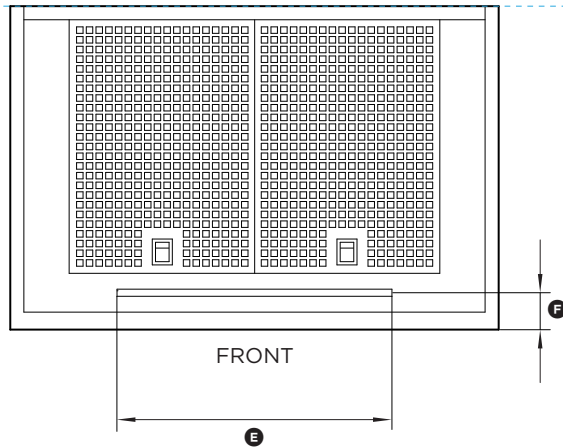

INDICATES PRODUCT DATUM

INDICATES CABINETY CLEARANCES

Dimensions may vary by 1/16" (±2mm).



# PRODUCT DIMENSIONS | HC36DCXB4

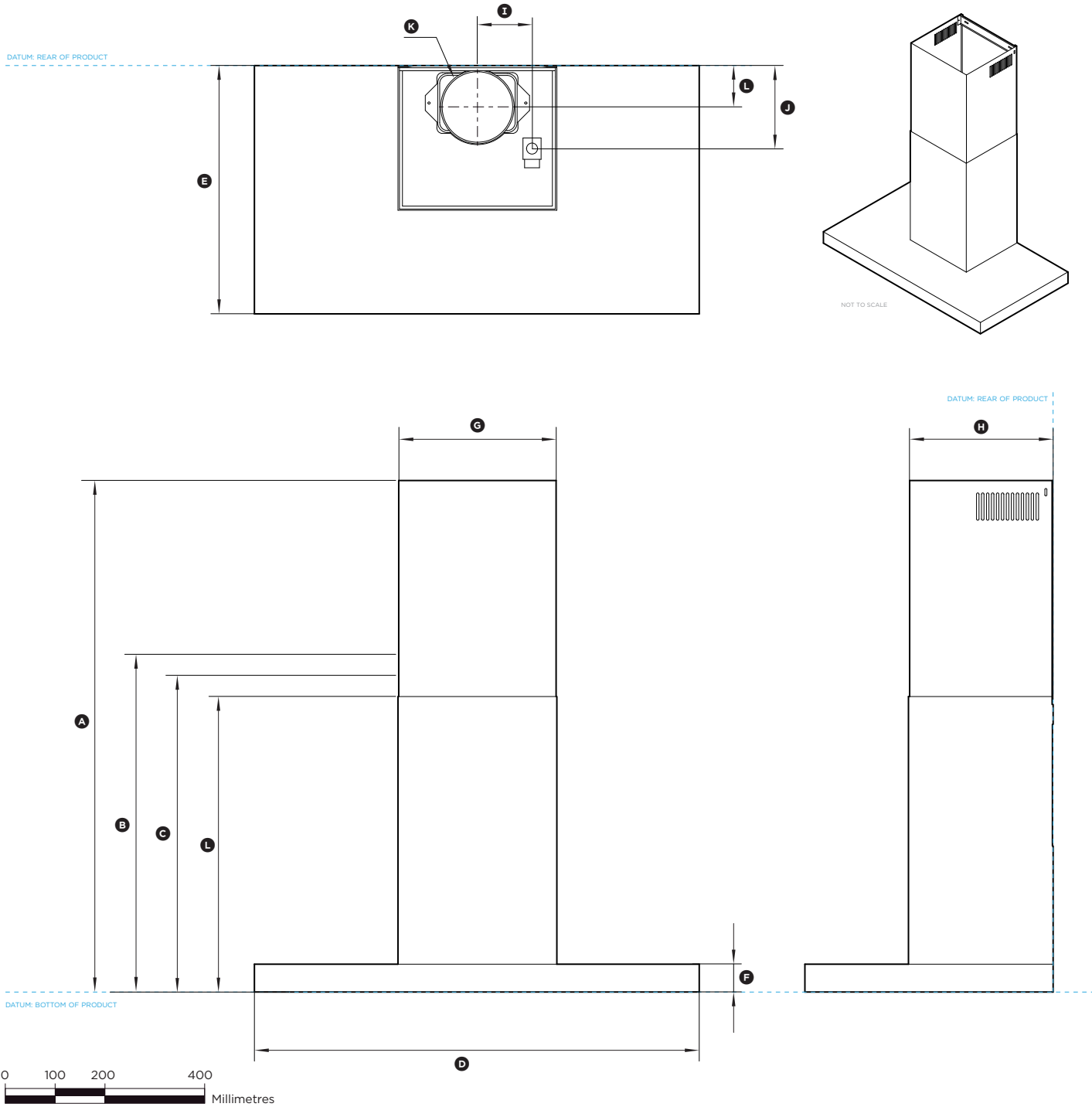

Product Dimensions	In	mm
Ⓐ Maximum height of rangehood*	40 3/4"	1035
Ⓓ Minimum overall height - recirculating	26 9/16"	675
Ⓔ Minimum overall height	25"	635
Ⓒ Overall width of rangehood	35 3/8"	898
Ⓔ Overall depth of rangehood	19 11/16"	500
Ⓕ Height of canopy	2 3/16"	55
Ⓖ Width of chimney	12 5/8"	320
Ⓙ Depth of chimney	11 7/16"	290
Ⓚ Distance from centre plane to hard wiring box centre	5 1/16"	129
Ⓛ Distance from back of product to centre of wiring box	6"	150
Ⓧ Ducting outlet diameter	6"	150
Ⓛ Distance from centre of ducting outlet to back of product	3 3/8"	85
Ⓧ Height of datum to top of lower chimney section	23 7/16"	595

\* Maximum height with chimney extension accessories 55 1/8" (1400mm).

Minimum distance above cooktops	In	mm
Height from base of product to cooking surface	min 24"	min 610

Note: Minimum installation height may be greater if required by your cooktop. Refer to cooktop installation instructions.

INDICATES PRODUCT DATUM -----  
INDICATES CABINETY CLEARANCES -----

Dimensions may vary by 1/16" (±2mm).

# PRODUCT DIMENSIONS | HC36DCXB4

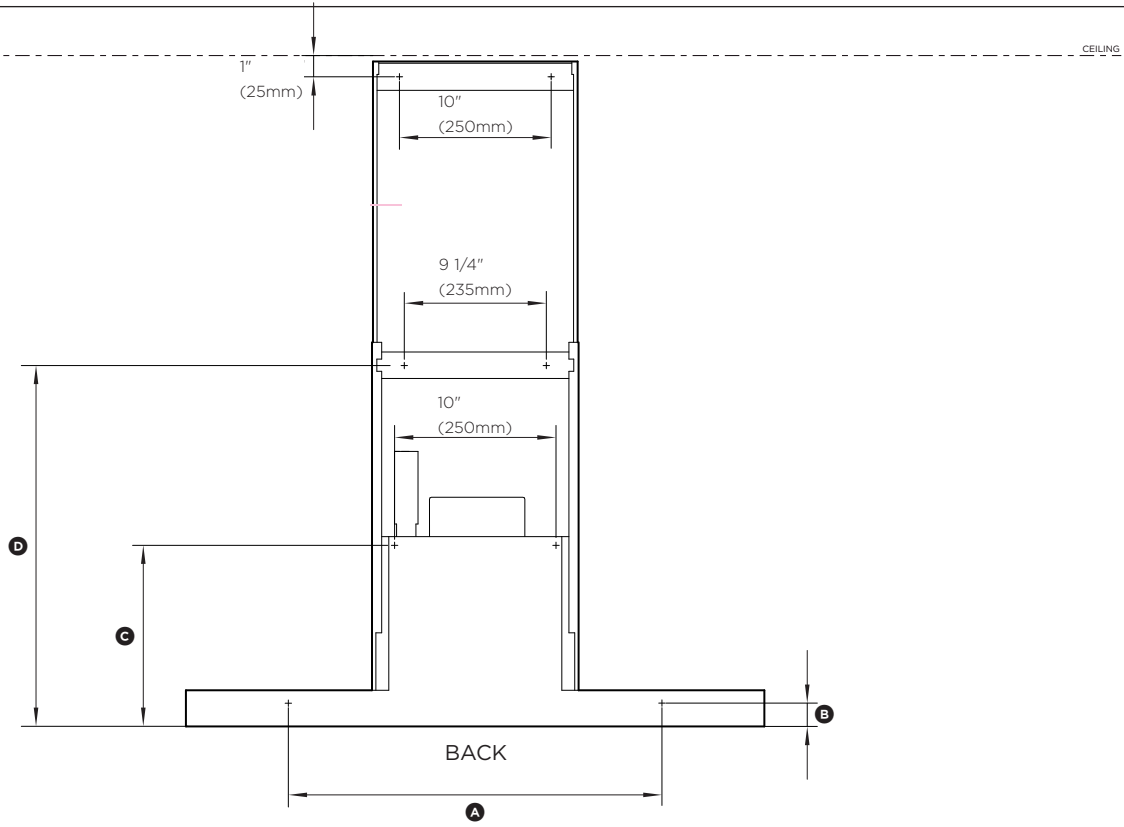

Product Dimensions	In	In
Ⓐ Lower range hood attachment point width	22 13/16"	580
Ⓑ Lower range hood attachment point height	1 7/16"	36
Ⓒ Upper range hood attachment point height	11 5/16"	288
Ⓓ Chimney bracket attachment point height	22"	558
Ⓔ Light length	28 9/16"	725
Ⓕ Distance from centre of light to front of product	2 3/16"	55

DATUM: REAR OF PRODUCT

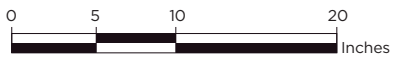
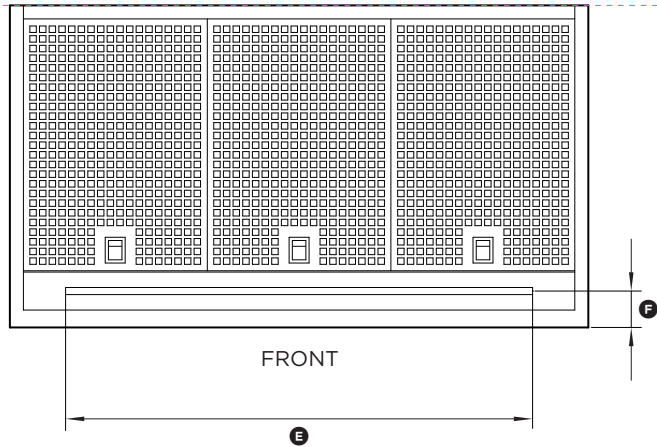

INDICATES PRODUCT DATUM

INDICATES CABINERY CLEARANCES

Dimensions may vary by 1/16" (±2mm).

## INSTALLATION HEIGHT

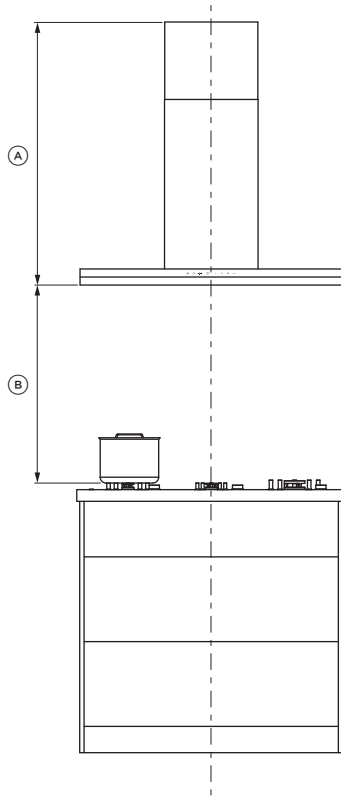

### Induction cooktop considerations

- Induction cooktops use energy efficient technology that only heats the contents of a cooking pot.
- Unlike gas or traditional electric cooktops, the surrounding air does not get heated when using an induction cooktop. As a result, rangehood filters, splashbacks and surrounding cabinetry do not get warmed up, increasing the likelihood of condensation on these cooler surfaces.
- Other factors like ambient temperature, humidity, natural ventilation of the room, size of the cookware and how the induction cooktop is being used also influence condensation. For example, aggressive boiling on high cooktop heat settings like PowerBoost increases the rate at which water is evaporated, increasing the likelihood of condensation.
- It is important to understand that neither the rangehood nor the induction cooktop are faulty as a result of this phenomenon.

### Condensation can be minimised by:

- Installing the rangehood at a greater distance above the cooktop.
- Using the rangehood on a lower speed setting when boiling.
- Using the induction cooktop on a lower heat setting when boiling.
- Switching the rangehood on 5 minutes before cooking and letting it run for at least 5 minutes after cooking. Refer to the 'Operating instructions' section on how to use the timer function.
- NOTE: recirculation does not remove moisture.

INSTALLATION DIMENSIONS	INCHES	MM
Ⓐ Installation height		
Ducted externally	25 - 40 13/16	635 - 1035
Recirculation mode	26 9/16 - 40 13/16	675 - 1035
With chimney extension	max 55 1/8	max 1400
Ⓑ Height from cooking surface to base of product	min 24	min 610

These rangehoods must be installed no lower than the minimum height indicated in the table above. Minimum installation height may be greater if required by the cooktop, refer to your cooktop installation guide.

## VENTING REQUIREMENTS

### Venting options

Attention should be given to ensure that any applicable regulations concerning the discharge of exhaust air are fulfilled.

The rangehood can be installed to operate with the exhaust air ducted externally from the kitchen, or installed to operate in recirculation mode with the exhaust air recirculating within the kitchen.

### Ducted externally

For an externally ducted installation it is recommended that 6" (150 mm) diameter, rigid or semi-rigid ducting is used. This will require a 6 5/16" (160 mm) minimum round hole in the ceiling or wall. Care should be taken to position the hole correctly.

For optimal efficiency use the shortest and straightest duct route possible and use rigid or semi-rigid ducting for reduced noise and increased airflow. Flexible metal ducting should only be used as a last resort (ie in difficult installations) and if used ensure that it is straight and smooth and extended as much as possible. All ducting should comply with local codes and regulations.

### Recirculation mode

To enable the product to operate with the air recirculating within the kitchen, please purchase a recirculation diverter and carbon filters (refer to the 'Parts and accessories' section). The recirculation diverter is installed after a short length of ducting and is required to channel the air out the side vents at the top of the chimney and the carbon filters are required to remove odours.

Note: a ducting hole is not required in the wall or ceiling if the rangehood is installed to operate in recirculation mode.

### Vent installation types:

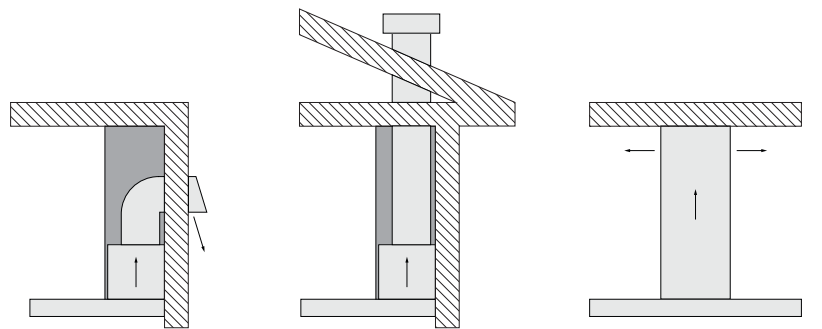

Vent through exterior wall

Vent through roof

Recirculate with carbon filters

## ELECTRICAL REQUIREMENTS

Before connecting the rangehood to the power supply, ensure the voltage and frequency indicated on the rating plate match that of the installation location:

MODEL	FREQUENCY	VOLTAGE	TOTAL POWER
HC24DCXB4	60HZ	120V	229W
HC30DCXB4	60HZ	120V	229W
HC36DCXB4	60HZ	120V	229W

## INSTALL PREPARATION / CONSIDERATIONS

①

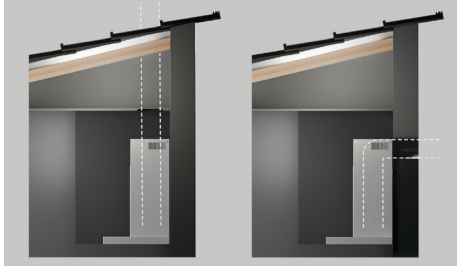

### Ducting options:

Duct to roof and out external wall or soffit.

Duct to external wall and out.

②

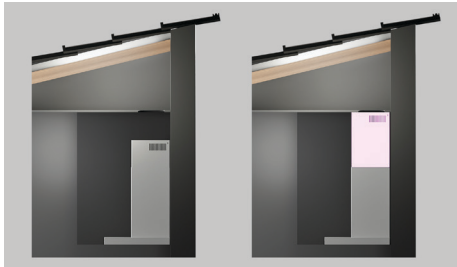

Ensure the space is set up to the correct specifications. Refer to 'Installation height' for details.

Determine if a chimney extension is required. Refer to 'components required' for part extension part numbers.

③



Refer to cooktop specifications to ensure adequate clearances are maintained.

④



Check wall is flat and constructed of appropriate materials that can support the rangehood.

①



Check for wall studs.\*

\*When no wall studs align with the desired installation location, cut a hole and secure wood behind plaster board to allow rangehood to be secured and mounted.

## CHECK MATERIALS AND PARTS

①



Ensure the ducting is the correct length and compatible to the rangehood.

## UNPACK PRODUCTS

①



Open carton and remove all packaging. Carefully lift the products out of the cartons.

Place on a protected surface.

②



Dispose of packaging responsibly. Recycle where possible.

③

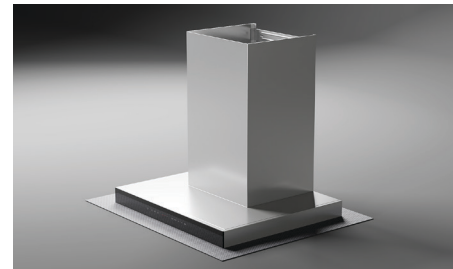

Inspect product for any damage. Connect to power and test.

## PREPARE INSTALL LOCATION

Centre rangehood over cooktop and ensure all required clearances are maintained.  
Check wall for studs. Using the guide shown, mark the upper and lower attachment points on the wall.

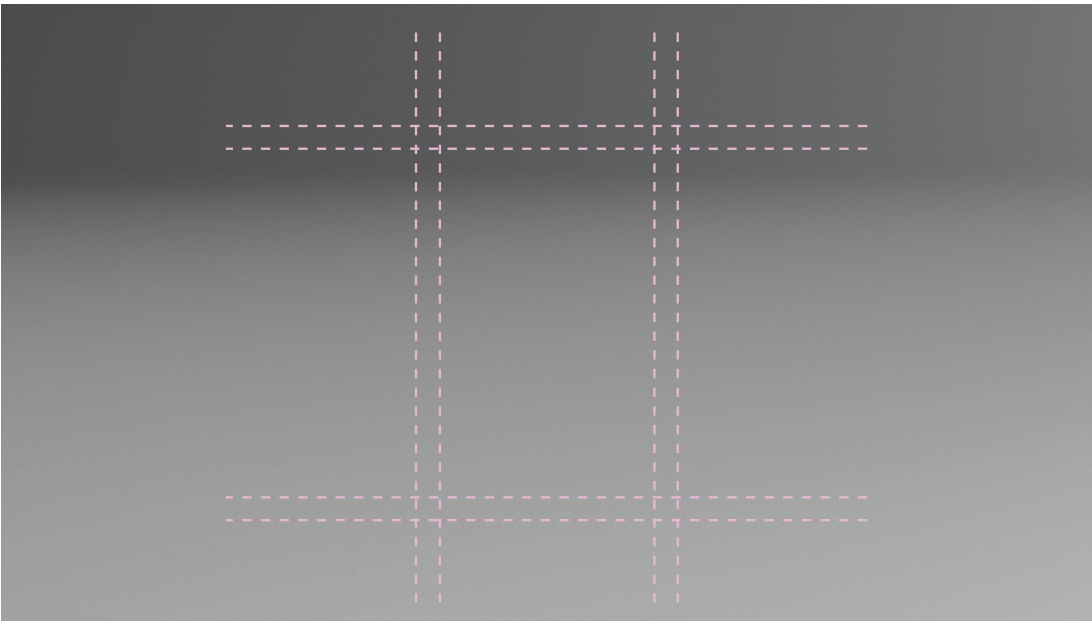

①



Drill attachment holes.  
Wood: 1/8" (3mm) diameter hole.  
Drywall or no wall stud: 3/16" (5mm) hole.

②



**If a cornice is present:**  
Remove a section equal to the width of the chimney. Refer to the product dimension page.

③

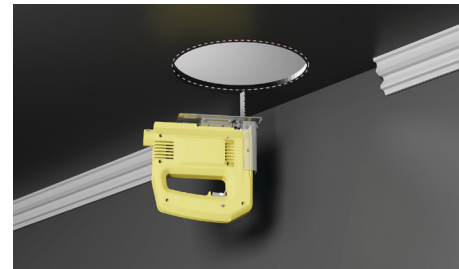

**Not required for recirculation installations:**  
Measure and mark the centre of the 6 5/16" (160mm) duct hole. Cut using a jigsaw.

## INSTALL BRACKETS

①

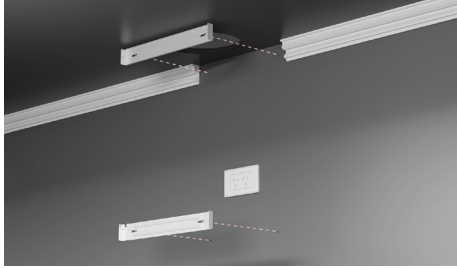

Centre and secure the upper and centre chimney brackets using two 1 3/16" (30mm) self tapping screws per bracket.

**If a cornice is present:**

Move the upper chimney brackets lower to avoid cornice clashing with chimney screws.

②

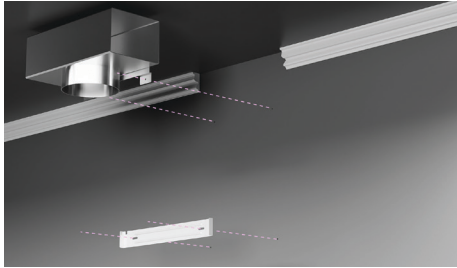

**Recirculation installation only:**

Align recirculation adapter to the upper bracket. Fit using 1 3/16" (30mm) Phillips screws.

## INSTALL DUCTING

### RIGID DUCTING

①

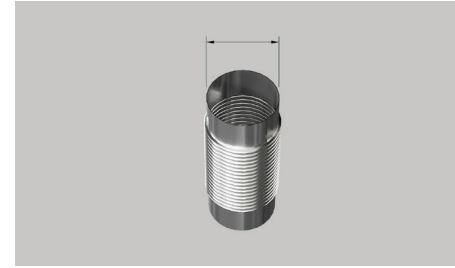

Ensure the ducting is the correct length and compatible to the rangehood.

Do not reduce the duct diameter as this will increase noise and reduce performance.

②



**Install external venting as required:**

Weather proofing requirements depend on the cladding/roofing type.

Soffit external venting.

③

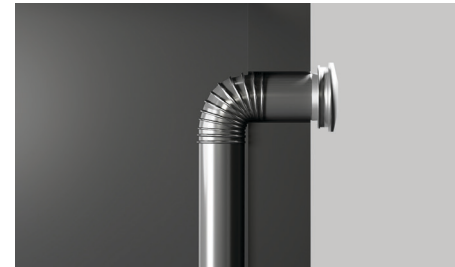

Install external venting as required:

Wall external venting.

④



Install external venting as required:

Roof external venting.



## INSTALL DUCTING

### RIGID DUCTING

5

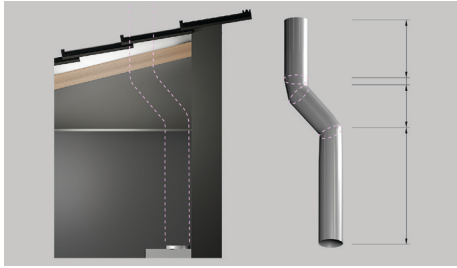

Cut ducting to length.

6



Route ducting and assemble.

7



Tape ducting to seal.

8



If required, secure ducting within ceiling.

9

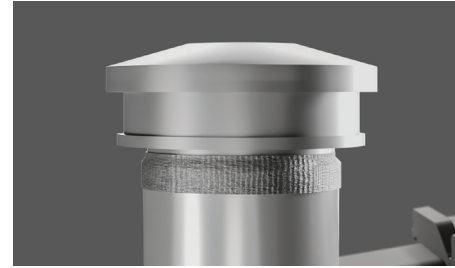

Fit ducting to the external vent and secure.

## PREPARE HOOD

①

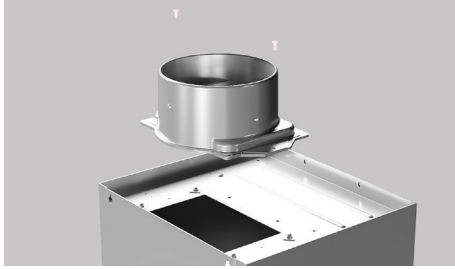

Fit the duct adapter to the rangehood using two supplied Phillips screws.

②



Unclip filters to remove.

## INSTALL HOOD

①

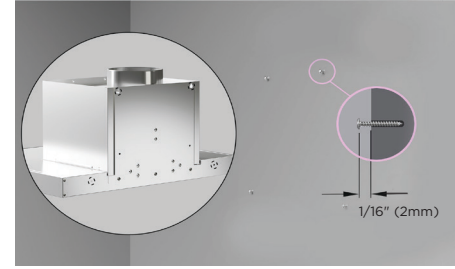

Install the 1 3/16" (30mm) upper hood mounting screws\* as per the product dimension page. Ensure both screws protrude 1/16" (2mm).

②

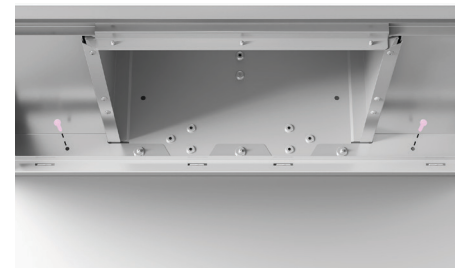

Lift the rangehood and slot onto the two upper hood mounting screws. Drill and secure the two supplied\* lower attachment screws through the holes underneath the rangehood.

③

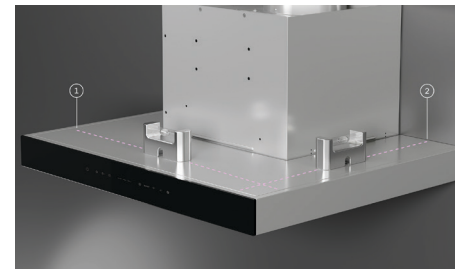

Level the front and side of the rangehood and adjust the two supplied lower attachment screws.

④

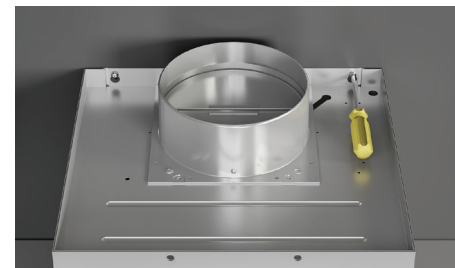

Tighten the two upper attachment screws. If the wall is uneven, loosen lower screws and install packers to level the rangehood to wall.

\*Use plastic wall plugs as required.

## SECURE DUCTING

①

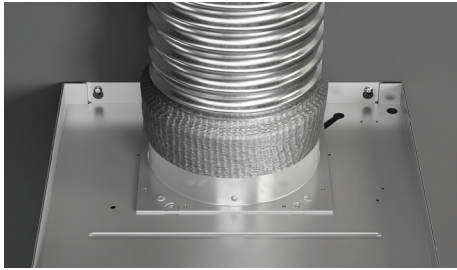

Attach ducting to the adapter.  
Secure using tape, cable ties or metal straps as required.  
Ensure backdraft damper flaps are not obstructed by the ducting.

## CONNECT POWER

①

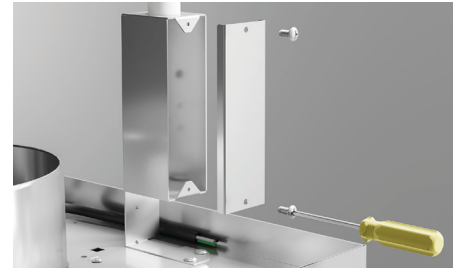

Remove the junction box cover by unscrewing both screws as shown.

②



Remove the electrical knock-out. Install a UL listed 1/2" (12.7mm) wiring conduit and strain relief in the junction box.  
Run three wires through the conduit from the power supply to the junction box.

③

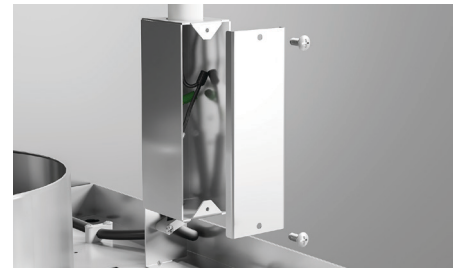

Connect the power supply wires to the rangehood wires using suitable UL listed wire nuts:  
Black to black.  
White to white.  
Green/yellow to green/yellow.  
Replace the junction box cover and secure.

# WIRING DIAGRAM

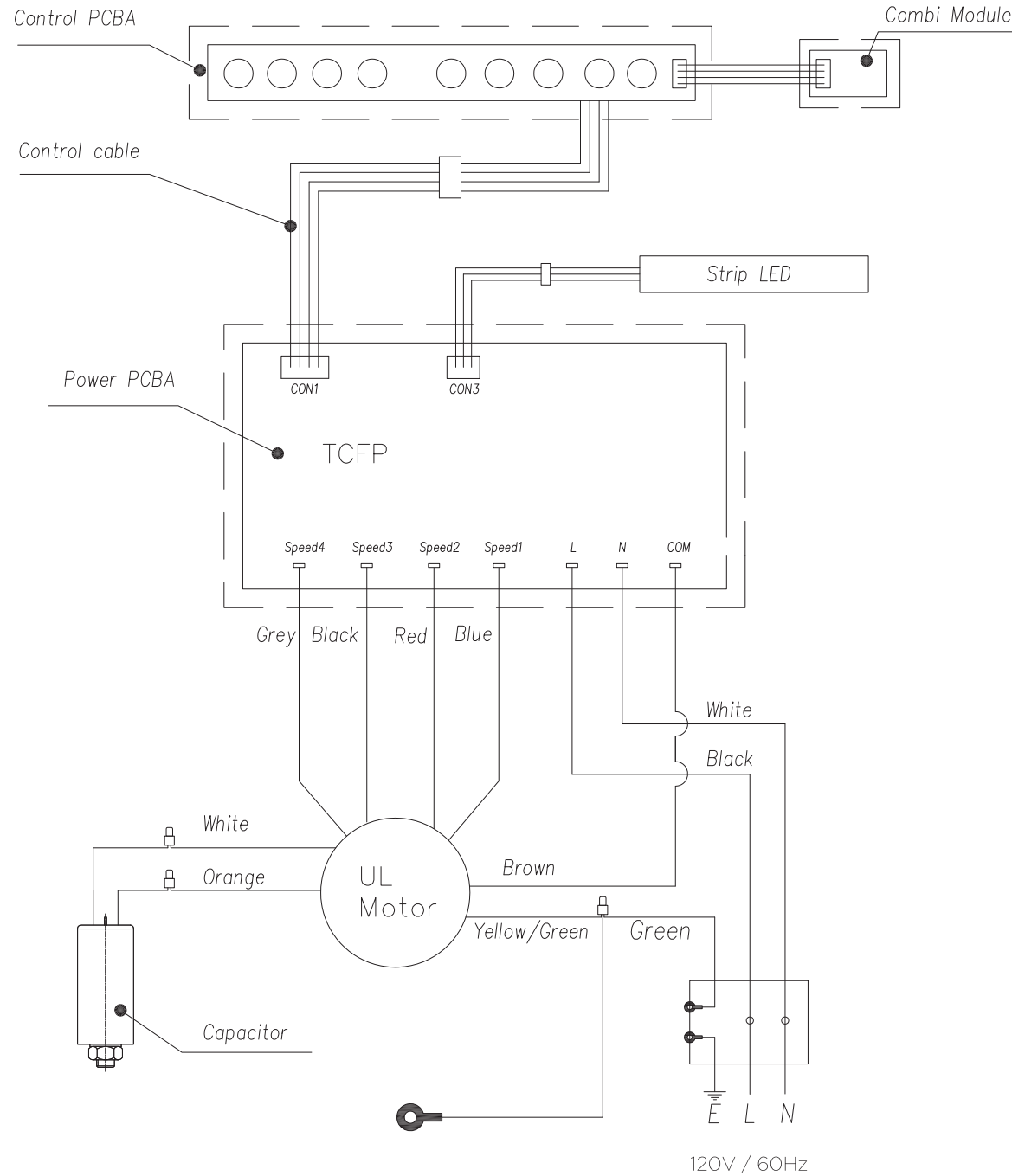

## INSTALL CHIMNEY

1

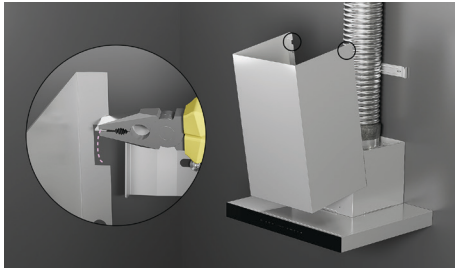

Remove the protective film from all chimney surfaces.  
Bend lower chimney tabs inwards using pliers.

2



Align the chimney to the lower chimney bracket and slot into place.

3



Extend the upper chimney and secure to the upper chimney bracket using two 3/8" (10mm) Phillips screws.

4

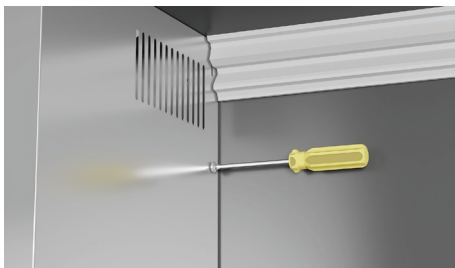

**If an adjacent cornice is present:**  
Two new holes in the chimney may be required to secure the rangehood to the wall if a cornice is present.

5



Remove the protective film from all chimney surfaces.  
Bend lower chimney tabs inwards using pliers.

6

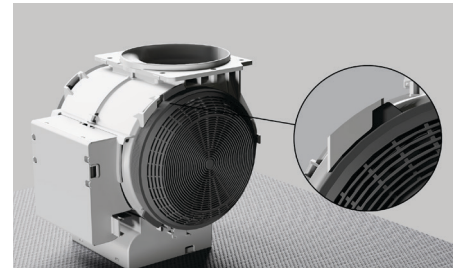

**Recirculation installations only:**  
Install the carbon filters onto the blower.  
Rotate the filter until secure.

## INSTALLER CHECKLIST

### TO BE COMPLETED BY THE INSTALLER

- Have all packaging been removed?
- Rangehood is correctly installed
- All connections are secure
- The ducting is not bent or crushed in any areas
- Check rangehood suction
- External vent is sealed appropriately
- All local regulations have been met
- Operation has been tested (refer to rangehood user guide)
- Check for unusual noises

## COMPLETE AND KEEP FOR SAFE REFERENCE

Model \_\_\_\_\_

Serial no. \_\_\_\_\_

Purchase date \_\_\_\_\_

Purchaser \_\_\_\_\_

Dealer address \_\_\_\_\_

Installer's name \_\_\_\_\_

Installer's signature \_\_\_\_\_

Installation company \_\_\_\_\_

Installation date \_\_\_\_\_

**FISHERPAYKEL.COM**

© Fisher & Paykel Appliances 2024. All rights reserved.

The models shown in this guide may not be available in all markets  
and are subject to change at any time.

The product specifications in this guide apply to the specific products and  
models described at the date of issue. Under our policy of continuous product  
improvement, these specifications may change at any time.

For current details about model and specification availability in your country,  
please go to our website or contact your local Fisher & Paykel dealer.

**106075A 06.24**