

60cm Series 9 Minimal Compact Combi-Microwave Oven

Series 9 | Minimal

Black



A flexible appliance that pairs the speed of microwave cooking with oven technology, which can crisp and brown as it cooks.

- 37L total capacity
- Nine cooking functions including Fan Forced, Fan Grill & Defrost
- Use the optional trim kit to integrate this microwave with your cabinetry

- Part of our suite of companion products, designed to match aesthetically for flexible configurations

DIMENSIONS

Height	458 mm
Width	596 mm
Depth	562 mm

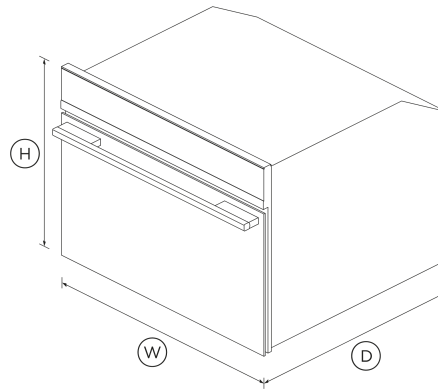

FEATURES & BENEFITS

Sized To Suit

A compact 46cm height means this Combination Microwave Oven can be placed almost anywhere. The companion products share the same dimensions and can be installed in multiple configurations to suit your kitchen design and preference.

Cooking Flexibility

Choice of nine cooking modes including Fan Forced and Grill giving you the best of microwave and convection oven technology.

Easy To Use

The intuitive touch display shows you all the information you need, allowing you to easily program in your desired cooking mode and duration.

Beauty Of Choice

With the choice of a stylish stainless steel or elegant black trim, our Companion products help you achieve a coherent kitchen aesthetic that suits your design style.

Easy Cleaning

This Combination Microwave Oven has formed side racks and a stainless steel interior that are easy to clean.

Safe & Sound

The CoolTouch door is safe to touch from the outside, protecting your hands and the surrounding cabinetry.

SPECIFICATIONS

Accessories (included)

Baking pan	1
Glass turntable	1
Wire shelf	1

Capacity

Shelf positions	3
Total capacity	37 L
Usable capacity	33 L

Cleaning

- Easy clean stainless steel interior
- Easy to clean formed side racks

Consumption

Microwave energy consumption **1.65 kWh**

Controls

- Audio feedback
- Automatic cooking/minute timer
- Celsius/Fahrenheit temperature
- Electronic capacitive touch controls
- Electronic oven control
- Intuitive touchscreen display
- Multi-language display **UK English, US English, Simplified Chinese, Français, Español**

Functions

- Defrost by time
- Defrost by weight
- Fan forced
- Fan grill
- Grill
- Microwave + grill
- Microwave + ring
- Microwave cooking
- Number of functions **9**

Ring + grill •

Performance

Grill power **1500 W**
 Microwave power **900 W**
 Microwave power levels **6**

Power requirements

Amperage **15 A**
 Supply frequency **50 Hz**
 Supply voltage **230 V**

Product dimensions

Depth **562 mm**
 Height **458 mm**
 Width **596 mm**

Safety

- Control panel key lock
- CoolTouch door

Warranty

Parts and labour **2 years**

SKU **81923**

The product dimensions and specifications in this page apply to the specific product and model. Under our policy of continuous improvement, these dimensions and specifications may change at any time. You should therefore check with Fisher & Paykel's Customer Care Centre to ensure this page correctly describes the model currently available. © Fisher & Paykel Appliances Ltd 2020

Other product downloads available at fisherpaykel.com

- ↓ [2D-DWG Combination Microwave Oven](#)
- ↓ [2D-DXF Combination Microwave Oven](#)
- ↓ [Archicad Combination Microwave Oven](#)
- ↓ [Archicad Combination Microwave Oven with 600mm Trim](#)
- ↓ [Archicad Combination Microwave Oven with 760mm Trim](#)
- ↓ [Data Sheet Combination Microwave Oven](#)
- ↓ [Service & Warranty](#)
- ↓ [Installation Guide](#)
- ↓ [Product Information Sheet](#)
- ↓ [Revit Combination Microwave Oven](#)
- ↓ [Revit Combination Microwave Oven with 600mm Trim](#)
- ↓ [Revit Combination Microwave Oven](#)
- ↓ [Rhino Combination Microwave Oven](#)
- ↓ [Rhino Combination Microwave Oven with 600mm Trim](#)
- ↓ [Rhino Combination Microwave Oven with 760mm Trim](#)
- ↓ [Sketchup Combination Microwave Oven](#)
- ↓ [Sketchup Combination Microwave Oven with 600mm Trim](#)
- ↓ [Sketchup Combination Microwave Oven with 760mm Trim](#)
- ↓ [User Guide](#)

Where applicable:

All appliances use energy, and energy usage typically generates carbon emissions. **Fisher & Paykel Appliances' In-use Energy Carbon Emissions Estimate** indicates carbon emissions from a product's in-use energy. This is calculated either annually or per cycle, using the product's market-specific energy label energy consumption data multiplied by the carbon emissions factor for energy in your country or region.

Our In-use Energy Carbon Emissions Estimate is designed to assist customers in making informed purchasing decisions when comparing different Fisher & Paykel products. For example, a heat pump dryer typically has a lower In-use Energy Carbon Emissions Estimate than a vented dryer.



A PEACE OF MIND SALE
24 Hours 7 Days a Week Customer Support
T 1300 650 590 W www.fisherpaykel.com