

FISHER & PAYKEL

BUILT-IN OVEN

CONTEMPORARY

OB60SC6LEB & OB60SC7LEB

USER GUIDE

NZ AU

CONTENTS

Safety and warnings	5
Before you begin	9
First use	10
Using the kitchen timer	15
Automatic cooking	17
Cooking guide	22
Cooking charts	26
Care and cleaning	32
Parts and accessories	42
Troubleshooting	43
Warranty and Service	45

Registration

To register your product visit our website: fisherpaykel.com/register

⚠ WARNING!



Electric Shock Hazard

Failure to follow this advice may result in electric shock or death.

- Turn the oven off at the wall before replacing the oven lamp.

⚠ WARNING!



Fire Hazard

Failure to follow this advice may result in overheating, burning, and injury.

- Do not place aluminium foil, dishes, trays, water or ice on the oven floor during cooking, this will irreversibly damage the enamel. Lining the oven with aluminium foil may cause fire.
- Never use your appliance for warming or heating the room. Persons could be burned or injured or a fire could start.
- Flammable materials should not be stored in an oven or near its surface.

⚠ WARNING!



Cut Hazard

Failure to use caution could result in injury.

- Take care: some edges may be sharp.

⚠ WARNING!

Hot Surface Hazard

Failure to follow this advice could result in burns and scalds.



- Accessible parts may become hot during use. Young children should be kept away.
- Surfaces of the appliance may become hot enough to cause burns. Examples include the oven vent, the surface near the oven vent, and the oven door.
- Do not touch heating elements or interior surfaces of the oven. Heating elements may be hot, even when they are dark in colour.
- Use protection when handling hot surfaces, such as oven shelves or dishes.
- Be careful when opening the oven door. Let hot air or steam escape before removing or replacing food.
- During and after use, do not touch or let clothing or other flammable materials contact heating elements or interior surfaces of the oven until they have had sufficient time to cool.

READ AND SAVE THIS GUIDE

WARNING!

To reduce the risk of fire, electrical shock, injury to persons or damage when using the oven, we recommend you follow the important safety guidance below. Be sure to read the user guide before using the oven. Use the oven only for its intended purpose and as detailed in this guide.

Installation

- Ensure your oven is properly installed and earthed by a qualified technician.
- Ensure your oven is connected to a circuit that incorporates an isolating switch providing full disconnection from the power supply.
- Do not install or operate your oven if it is damaged or not working properly. If you receive a damaged product, contact your dealer or installer immediately.
- This product must not be installed behind a decorative door in order to avoid over-heating.

Servicing

- Do not repair or replace any part of your oven unless specifically recommended in the user guide.
- All other servicing of your oven should be undertaken by a Fisher & Paykel trained and supported service technician or qualified person.

Fire hazard

- Do not use water on grease fires. Smother the fire or flame, or use a dry chemical- or foam-type extinguisher.
- Use only dry oven mitts or potholders as moist or damp potholders on hot surfaces could result in burns from steam. Do not let potholders touch hot areas or heating elements. Do not use a towel or a bulky cloth for a potholder as it could catch fire.
- Do not heat unopened food containers as they can build up pressure that may cause the container to burst, which may result in injury.

Food safety

- Leave food in the oven for as short a time as possible before and after cooking to avoid contamination by organisms that may cause food poisoning. Take particular care during warm weather.

General use

- Caution: Hot air can blow from the vent at the top of the oven as part of the oven's cooling system.
- Household appliances are not intended to be played with by children.
- Children should not be left alone or unattended in the area where your oven is in use. They should never be allowed to sit or stand on any part of the appliance.
- Children must be kept away from your oven unless continuously supervised.
- This appliance can be used by children aged 8 years and above and persons with reduced physical, sensory or mental capabilities or lack of experience and knowledge if they have been given supervision or instruction concerning use of the appliance in a safe way and understand the hazards involved.

SAFETY AND WARNINGS

- Cleaning and user maintenance shall not be carried out by children without supervision.
- Do not store things children might want above the oven. Children could be burned or injured while climbing on your oven to retrieve items.
- Do not place heavy objects on the oven door. Always keep oven vents unobstructed.
- Do not wear loose fitting or hanging garments when using the appliance. They could ignite or melt if they touch an element or hot surface and you could be burned.
- Always position shelves in the desired location before preheating and while the oven is cool. If a shelf must be removed while the oven is hot, do not let the oven mitts or potholder make contact with the hot heating elements in the oven or the base of the oven.
- Use only bakeware approved for oven use. Follow manufacturers' instructions.

Cleaning

- Do not clean the oven seal or use any oven-cleaning products on it. This will preserve the seal and ensure that the oven operates efficiently. Care should be taken not to rub, damage or move the oven seal.
- Do not use oven cleaners, harsh or abrasive cleaning agents, waxes, or polishes. No commercial oven cleaner, oven liner or protective coating of any kind should be used in or around any part of the oven.
- Do not use harsh or abrasive cleaners, scourers or sharp metal scrapers to clean the oven door glass, since they scratch the surface, which may result in the glass shattering.
- Clean only the parts listed in this user guide.
- Do not use a steam cleaner to clean any part of the oven.

BEFORE YOU BEGIN

- Your oven must be installed by a suitably qualified person according to the installation guide. The installer should complete the final installer checklist.
- Read this guide, taking special note of safety and warnings.
- Remove all internal and external packaging and recycle it responsibly where possible.
- Refit the shelves to your desired position in the oven.
- Condition the oven following guidance in first use.

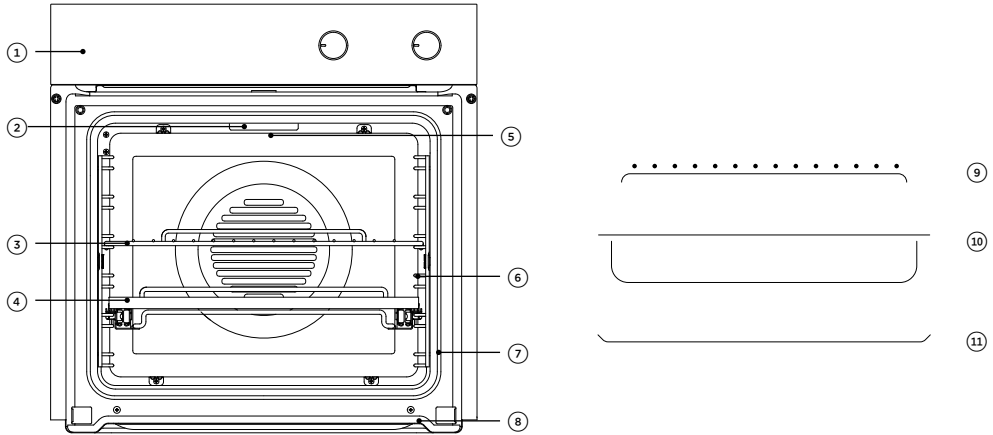

Oven features and accessories

- | | |
|--------------------------------|--------------------|
| ① Control panel | ⑦ Oven seal |
| ② Oven vent louvre | ⑧ Drip channel |
| ③ Wire shelf | ⑨ Grill rack |
| ④ Full extension sliding shelf | ⑩ Roasting dish |
| ⑤ Oven light location | ⑪ Flat baking tray |
| ⑥ Side rack | |

The oven door, handle and step down wire shelf are not illustrated.

Not all accessories are provided with all models. To purchase other accessories, contact your nearest Fisher & Paykel Service Centre, Customer Care or visit www.fisherpaykel.com

FIRST USE

Oven racks

Your oven comes with the shelves positioned and secured inside. The following shows you how to remove and reposition them to your preferred position.

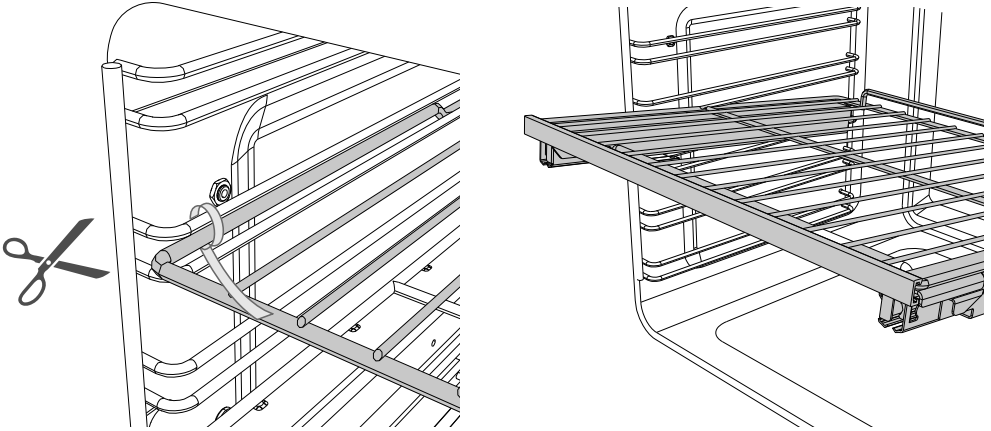

Remove shelves from oven

- ① Remove all cable ties and packaging holding shelves in place.
- ② Remove all shelves, taking special care with sliding shelves.
- ③ To remove a sliding shelf, grip it at the front (making sure you are gripping the wire shelf and sliding frame together), lift upwards and pull it out of the oven.

For your safety, the wire shelves and sliding frames are built together as one unit and are not separable. When placed properly on the side racks, the slides prevent the wire shelves from tilting when pulled towards you.

FIRST USE

Replace shelving in your preferred positions

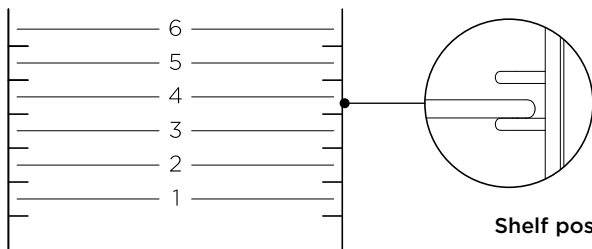

Shelf positions

We recommend placing the sliding shelves on positions 2 and 4 for everyday cooking.

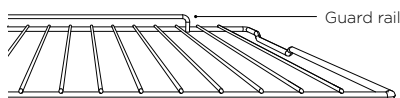

To replace wire shelves

Check the shelf is positioned correctly, with the guard rail at the back, then slide into place on the side racks. The shelf must sit between the two wires of the shelf position.

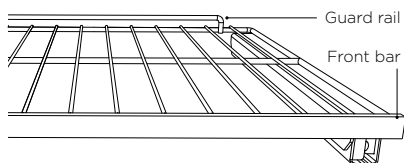

To replace sliding shelves (OBSC6 only)

- ① Grip the shelf at the front, making sure you hold the wire shelf and the sliding frame together.
- ② Ensure the shelf is level and facing the right way with the guard rail at the back.
- ③ Place the shelf on top of the side racks at the desired height, hooking the rear tags over the side racks on both sides.
- ④ Push the shelf all the way into the oven, ensure the front tags are also securely hooked over the side racks.

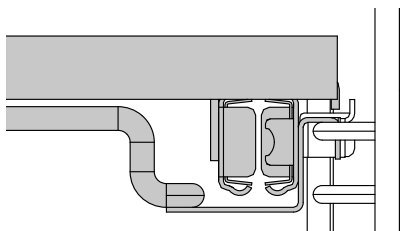

Ensure sliding shelves are positioned on top of the side rack wires not between them.

When there is food in the oven, take care to slide the shelves horizontally when extending them. This will prevent the tags lifting off the side racks and the shelf tipping over.

FIRST USE

Control panel

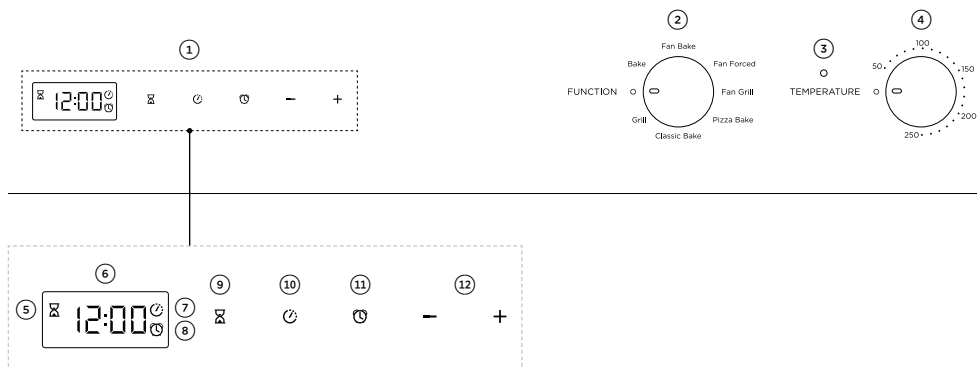

Control panel features

- | | |
|--------------------------|--------------------------------------|
| ① Display | ⑦ Cooking time indicator** |
| ② Function dial | ⑧ Automatic cooking stop indicator** |
| ③ Temperature indicator* | ⑨ Timer control |
| ④ Temperature dial | ⑩ Cooking time control |
| ⑤ Timer indicator | ⑪ Stop time control |
| ⑥ Clock | ⑫ - and + controls |

* Will be lit while the oven is heating up.

**Will be lit if the option is in use.

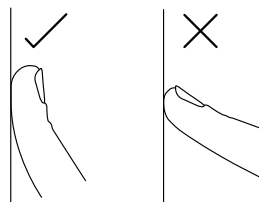

Using the touch controls

Use the ball of your finger, not its tip. The controls respond to touch, so pressure is not needed.

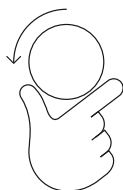

Dials

Turn the dials to select the cooking function and temperature.

FIRST USE

Setting the clock

You'll need to set the time on your oven when it is first turned on, or after a power failure. The oven will not function if the clock is not set.

①

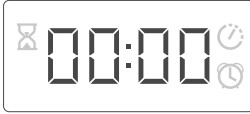

When the power to the oven is turned on or restored after a power failure, 00:00 will flash in the display.

②

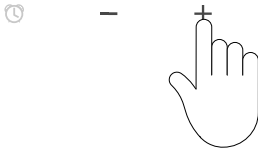

Touch the - or + controls to set the time.

③

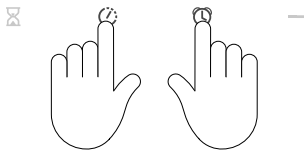

Touch the cooking time ⌚ and stop time ⌚ controls together for two seconds to accept the time.

- The display will stop flashing.
- The oven will beep to confirm the time is set.

To change the time

①

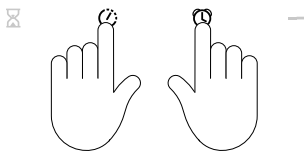

Touch the cooking time ⌚ and stop time ⌚ controls together for two seconds. The centre dot will flash.

Follow steps ② and ③ above to change the time.

FIRST USE

Conditioning the oven

It is important to condition your oven before using it for cooking. This will burn off any manufacturing residues and ensure that you get the best results right from the start.

Before you start:

Make sure you have removed all packaging and any cable ties used to secure the shelving during transit. Ensure all shelves are fitted in the oven, the clock is set and the kitchen is well ventilated during conditioning.

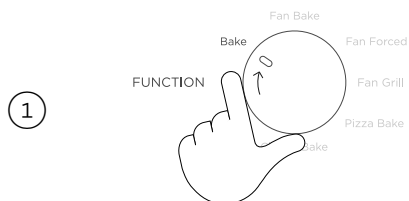

Select **BAKE** function and set the oven to 200°C for 30 minutes.

While the oven is heating up, the temperature indicator light will glow.

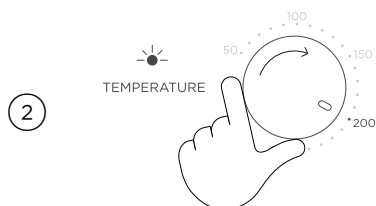

When the oven has reached set temperature, the temperature indicator light will go out.

If the clock has not been set, the cooling fans will come on, but the oven light will not come on and the oven will not heat up.

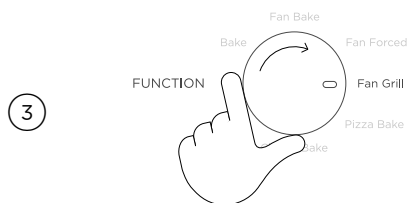

After 30 minutes change the function to **FAN GRILL** and heat for 20 minutes.

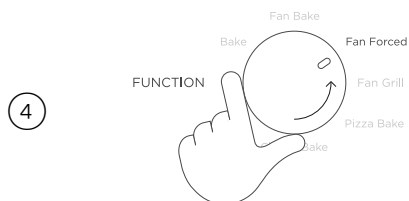

After 20 minutes, change the function to **FAN FORCED** and heat for a further 20 minutes. When you have finished, turn the oven off.

After conditioning:

There will be a distinctive smell and a small amount of smoke during the conditioning process as manufacturing residue is burnt off. This is normal, but ensure the kitchen is well ventilated. Once cooled, wipe out the oven with a damp cloth and mild detergent, and dry thoroughly.

USING THE KITCHEN TIMER

Use the kitchen timer to keep track of cooking times. You can use it at any time, even if you are not using the oven. The time counts down in minutes (hours:min) until the last five minutes of cooking, when it will countdown in seconds (min:sec). You can set the timer for up to four hours.

The timer does not turn the oven off.

Setting the timer

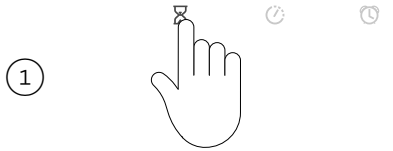

Check the display shows the correct time of day.

Touch the timer ⌚ control.



The display will show 00:00. The timer indicator ⌚ and dot will flash.

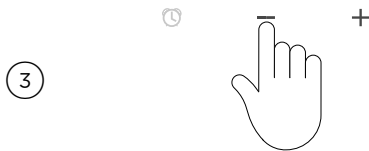

Touch the — and + controls to set the timer.

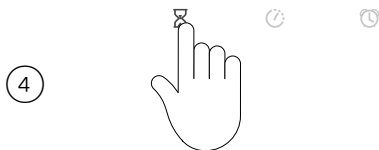

Touch the timer ⌚ control to confirm or wait five seconds and the display will show the time of day and the timer indicator ⌚.

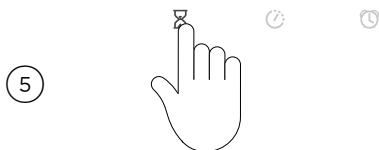

To check the time remaining, touch the timer ⌚ control.
During the last five minutes of the countdown the display will show the time remaining.

USING THE KITCHEN TIMER

6



At the end of the countdown

The timer will beep every seven seconds. The timer indicator  will flash and the display will show **00:00**.

To stop the beeping and return to the time of day, touch any control.

Editing or cancelling the timer

1

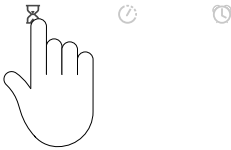

Touch the timer  control to show the remaining time.

2

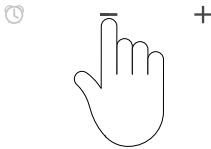

To edit

Touch the **—** and **+** controls and scroll the time up or down.

3

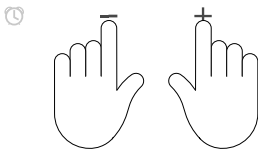

To cancel

Touch and hold the **—** and **+** controls together until the display shows **00:00**.

4

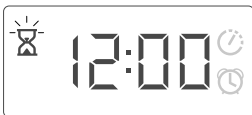

The timer indicator and display will flash for a few seconds and then return to the time of day.

AUTOMATIC COOKING

You can set the oven to automatically turn on, cook for a preset time (cooking time), then automatically turn off at a preset stop time. You can also start cooking manually and set the oven to turn off automatically after the required cooking time or at a set time of day.

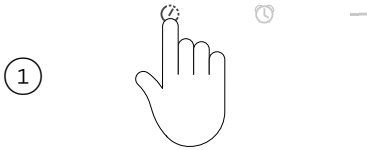

Check the clock shows the correct time of day.

Touch the cooking time ⚡ control. The cooking time ⚡ indicator will flash.



Touch the — and + controls to set the cooking time. Ensure you allow for preheat time in your calculation.

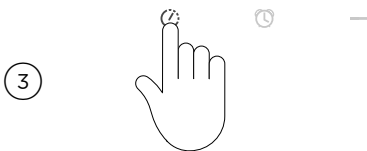

Touch the cooking time ⚡ control to confirm.

The cooking time ⚡ indicator will stop flashing and remain on.

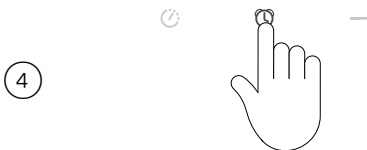

Touch the stop time ⌚ control. The stop time indicator will flash \bar{H} .

AUTOMATIC COOKING

5

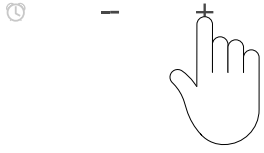

Touch the - and + controls to set the time you would like your food to be ready by (ie the stop time).

6

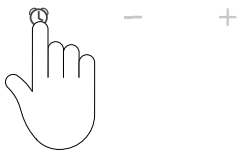

Touch the stop time icon control to confirm. The \bar{H} will stop flashing and remain on and the display will show the time of day.

7

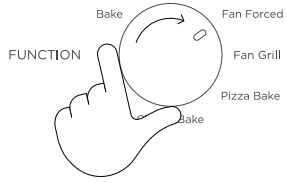

Select a function. The oven will come on.

If you have set the oven to automatically turn on later, the oven cooling fan will come on when you select a function, but the light will be off and the oven will not heat up.

8

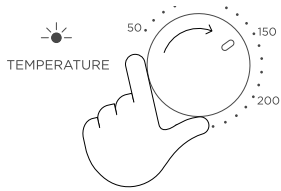

Set the temperature.

AUTOMATIC COOKING

To check the set cooking time

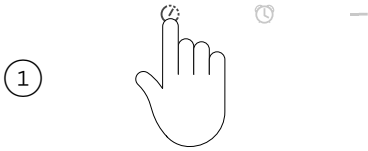

Touch the cooking time ⌚ control.

To modify the set cooking time

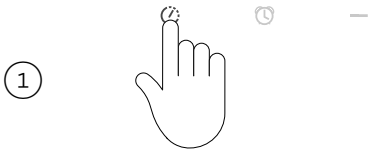

Touch the cooking time ⌚ control. The cooking time ⌚ indicator will flash.

You can modify the set cooking time by using the — and + controls. Touch the cooking time ⌚ control again to set.

To cancel the cooking time

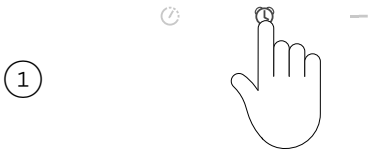

Touch the stop time ⏸ control.

Touch the — control and scroll the time down to 00:00.



Touch the cooking time ⌚ control to accept.

This will not turn off the oven. If the stop time is set the oven will turn off when the stop time is reached.

AUTOMATIC COOKING

To check the stop time

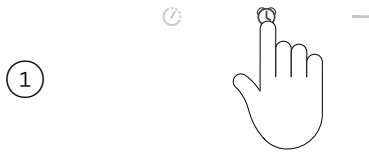

Touch the stop time ⌚ control.

To modify the stop time

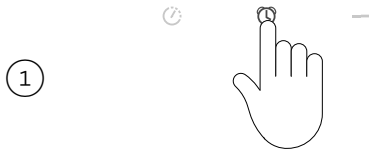

Touch the stop time ⌚ control. The stop time *H* indicator and dot will flash.
You can modify the set cooking time by using the — and + controls. Touch the stop time ⌚ control again to set.

To cancel automatic cooking

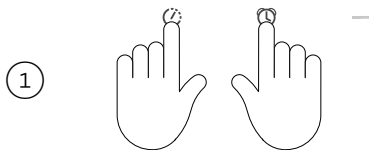

Touch the cooking time ⌚ control and the stop time ⌚ control together for two seconds.

Turn the function and temperature dials to **OFF**.



When the stop time is reached

The oven will automatically turn off and the oven will beep every seven seconds. The cooking time ⌚ and the stop time *H* indicator will flash. Turn the function and temperature dials back to **OFF**. Press any control to exit automatic cooking.

If the oven function dial has not been turned back to **OFF** when you exit automatic cooking, the oven will turn back on.

AUTOMATIC COOKING

When automatic cooking is set

The oven light will stay off but your oven is now set for automatic cooking. It will automatically heat up at the required time. The display will show the time of day with the cooking time  and stop time  indicators are lit. The cooling fan will continue to run.

You can modify the function and temperature before and during cooking. The grill element will come on while the oven is heating up. Uncovered foods may be browned on top.

Safe food handling

Leave food in the oven for as short a time as possible before and after cooking or defrosting, to avoid contamination by organisms which may cause food poisoning. Take particular care during warmer weather.

COOKING GUIDE

General guidelines

This oven has been designed to utilise its four elements and rear fan in different combinations for enhanced performance. The wide range of functions allows you to cook all food types to perfection.

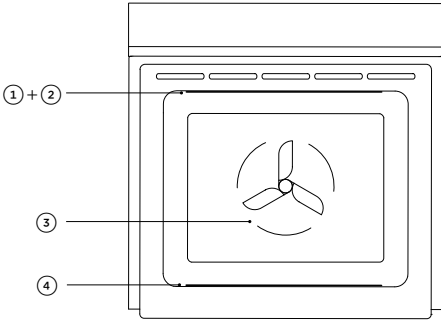

Oven elements

- ① upper outer element
- ② upper inner element
- ③ rear element (concealed)
- ④ lower element (concealed)

Use all the functions with the oven door closed.

Baking

- For best results when baking, always pre-heat your oven. The temperature indicator will go out when the pre-set temperature is reached.
- While the oven is heating the grill element may be on.
- **Single shelf cooking:** place your baking on a shelf that will position the top of your pan near the centre of the oven.
- **Multi shelf cooking:** Always leave a space between shelves to allow the air to circulate.

Grilling

- Always grill with the oven door completely shut.
- Always keep a close watch on your food to avoid charring or burning.
- If you use glass or ceramic pans, be sure they can withstand high oven temperatures.
- For thinner cuts of meat, or for toasting or browning foods, use a higher shelf position.
- Thicker cuts of meats should be grilled on lower shelves or at a lower grill setting to ensure even cooking.

Roasting

- Use **FAN GRILL** to roast whole chicken.
- For other meats use **BAKE** for a succulent juicy flavoursome roast.
- Boneless, rolled or stuffed roasts take longer than roasts containing bones.
- Poultry should be well cooked with the juices running clear and an internal temperature of 75°C.
- For crispy crackling first sear the pork at a high temperature, then lower the temperature to complete the cooking.

COOKING GUIDE

- If multi-shelf cooking (eg if roasting meat on one shelf and vegetables on another) use **FAN FORCED**.
- Cook larger cuts of meat for longer at a lower temperature. The meat will cook more evenly.
- Always roast meat fat side up.

Reheating

Never reheat food more than once.

- Use **BAKE** or **FAN BAKE** to reheat food.
- Always reheat food to piping hot, or to a minimum internal temperature of 85°C. This reduces the risk of contamination.
- Reheat food in a dish with a lid or cover tightly with foil.

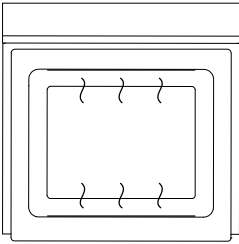

BAKE
upper outer and lower elements

Ideal for:

foods that require a longer cooking time or at low temperatures eg rich fruit cake and brownies.

- Retains moisture.
- This function is not suitable for multi-shelf cooking.

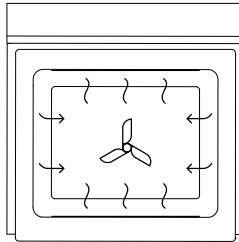

FAN BAKE
fan plus upper outer and lower elements

Ideal for:

single shelf baking that requires less than an hour to cook. Foods such as muffins, biscuits and cupcakes.

- The oven fan circulates hot air from the top outer and the lower elements and distributes it around the oven cavity.
- Food cooked tends to brown quickly.

COOKING GUIDE

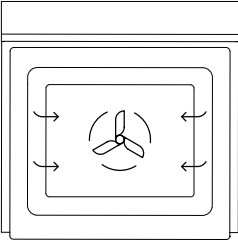

FAN FORCED fan plus rear element

Ideal for:

multi-shelf cooking, eg biscuits, cookies, scones, muffins and cupcakes.

- Hot air is blown into the cavity, providing a consistent temperature at all levels.
- Always leave a gap between shelves to allow air to move freely. This ensures food on the lower tray can still brown.
- If converting a recipe from **BAKE** to **FAN FORCED**, we recommend that you decrease either the bake time and/or the temperature by approximately 20°C, especially for items with longer bake times.

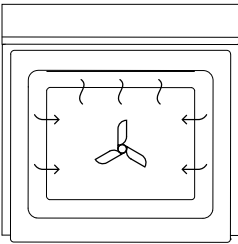

FAN GRILL fan plus upper outer and inner elements

Ideal for:

whole chicken, beef tenderloin or grilling fish or steak.

- Uses the intense heat from the elements for top-browning and the fan to ensure even cooking of foods.
- Meat, poultry and vegetables cook beautifully; food is crisp and brown on the outside while the inside remains moist and tender.

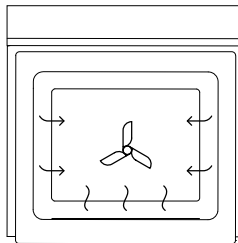

PIZZA BAKE fan plus lower element

Ideal for:

crisp-based pizzas.

- The fan circulates heat from the lower element throughout the entire oven.
- Excellent for cooking pizza as it crisps the base beautifully without overcooking the topping.
- For best results, pre-heat a pizza stone for at least 1 hour and bake on oven shelf position 1 or 2.

COOKING GUIDE

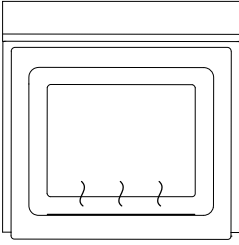



 **CLASSIC BAKE** (some models only)
lower element

Ideal for:

dishes that require delicate baking and have a pastry base, like custard tarts, pies, quiches and cheesecake.

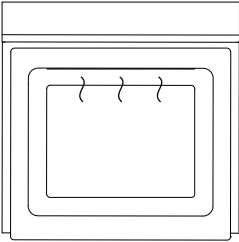
- Heat comes from the lower element only.
- This is the traditional baking function, suitable for recipes that were developed in conventional ovens.
- Bake using only one shelf at a time.



 **GRILL**
upper inner and outer elements

Ideal for:

toasting bread or for top-browning to finish off dishes.

This function delivers intense radiant heat from the top element(s). You can set the intensity of the heat by altering the temperature setting.

- The most suitable function for 'finishing off' many meals, for example browning the top of potato gratin and frittata.

COOKING CHARTS

Shelf positions

- Position shelves before you turn the oven on.
- Shelf positions are counted from the base up, with 1 being the lowest shelf position and 6 the highest.

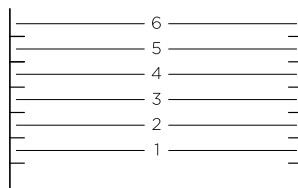

During cooking

- Preheat the oven to the required temperature.
- The grill element will come on while the oven is heating up.
- The temperature indicator will be lit while the oven is heating up.
- Oven accessories may temporarily warp slightly when they become hot. This is normal and does not affect their function.

The information in these charts is for guidance only. Refer to your recipe or the packaging and be prepared to adjust the cooking times and settings accordingly.

BAKING	SHELVES	FUNCTION	SHELF POSITION	TEMP (°C)	TIME (MIN)
BISCUITS					
Plain	Single	Fan Bake	4	180-190	13-17
	Multi	Fan Forced	3 and 5	160-170	13-17
Chewy choc chip	Single	Fan Bake	4	180-190	15-20
	Multi	Fan Forced	3 and 5	160-170	15-20
Oatmeal	Single	Pizza Bake/Fan Bake	4	160-170	12-15
SLICES/SQUARES	Single	Pizza Bake/Fan Bake	3	160-165	15-20
CAKES					
Vanilla	Single	Bake	4	160-165	30-35
Butter/chocolate	Single	Bake	4	160-180	50-60
Light fruit	Single	Bake	2	155-165	1hr 30
Rich fruit	Single	Classic Bake/Bake	2	120-160	2.5 hrs
Sponge (single large)	Single	Bake	2	175	30-40
Sponge (2 small pans)	Single	Bake	2	170-190	15-25

COOKING CHARTS

BAKING	SHELVES	FUNCTION	SHELF POSITION	TEMP (°C)	TIME (MIN)
SHORTBREAD	Single	Pizza Bake/Fan Bake	3	130-140	20-25
MUFFINS/CUPCAKES	Single	Fan Bake	3	180-190	13-17
	Multi	Fan Forced	2 and 4	160-170	16-21
SCONES	Single	Fan Bake	2	210-230	8-12
	Multi	Fan Forced	1 and 3	210-230	8-12
MERINGUES	Single	Bake	1	100-120	60
BREAD ROLLS	Single	Bake	4	195-210	25-35
PASTRY					
Filo	Single	Fan Bake	3	190-200	15-25
Flaky/puff	Single	Bake	3	185-200	20-30
Choux	Single	Bake			
	Multi	Fan Forced	2	200-210	30-35
Croissants	Single	Bake	-	-	-
	Multi	Fan Forced	3	190-200	15-25
PIES					
Apple	Single	Pizza Bake	2	190-200	25-30
Lemon meringue	Single	Pizza Bake	2	175-180	30-40

COOKING CHARTS

SAVOURY	SHELVES	FUNCTION	SHELF POSITION	TEMP (°C)	TIME (MIN)
PIES					
Chicken/Steak/Mince	Single	Pizza Bake/Fan Bake	3	190-195	30-40
SAUSAGE ROLLS	Single	Pizza Bake/Fan Bake	3	190-195	30-40
MEAT LOAF	Single	Bake	3	175-180	55-65
PIZZA					
Classic	Single	Pizza Bake	1 and 2	225-250	8-12
Thin crust	Single	Pizza Bake	1 and 2	250	5-8
Deep dish	Single	Pizza Bake	1 and 2	160-220 ¹	50-60
LASAGNE	Single	Fan Bake	3	175-180	45-50
QUICHE	Single	Pizza Bake/Fan Bake	2	180-200	30-40
POTATOES					
Traditional Baked	Single	Bake	3	175-190	40-50
FRITTATA					
Grill to finish	Single	Pizza Bake/Fan Bake	3	170-180	30-45
CASSEROLES	Single	Bake	3	170-190	55-70
OVEN MEALS	Single	Fan Forced/Fan Bake	3	170-190	30-40

COOKING CHARTS

ROASTING	SHELVES*	FUNCTION	SHELF POSITION	TEMP (°C)	TIME (MIN)
BEEF, BONELESS (times per 450g)					
Rare	Single*	Bake	3	160-170	18-32
Medium	Single*	Bake	3	160-170	25-40
Well done	Single*	Bake	3	160-170	30-55
PRIME RIB ROAST (times per 450g)					
Rare	Single*	Bake	3	160-170	15-30
Medium	Single*	Bake	3	160-170	20-35
Well done	Single*	Bake	3	160-170	25-40
LAMB LEG, BONE IN (times per 450g)					
Medium	Single*	Bake	3	160-170	18-28
Well done	Single*	Bake	3	160-170	20-33
LAMB LEG, BONELESS (times per 450g)					
Medium	Single*	Bake	3	160-170	20-35
Well done	Single*	Bake	3	160-170	25-45
CHICKEN (times per 1lb/450g)					
Whole	Single*	Fan Grill	3	175-190	15-20
TURKEY, WHOLE (times per 450g)					
With stuffing	Single*	Bake	1	165-175	17-22
Without stuffing	Single*	Bake	1	150-165	15-20
PORK CRACKLING					
Crisp		Bake	3	250	20
VEAL (times per 450g)					
Medium	Single*	Bake	3	160-170	20-40
Well done	Single*	Bake	3	160-170	25-45
PORK, BONELESS (times per 450g)					
Medium	Single*	Bake	3	170-175	25-40
Well done	Single*	Bake	3	170-175	30-45

COOKING CHARTS

ROASTING	SHELVES*	FUNCTION	SHELF POSITION	TEMP (°C)	TIME (MIN)
VENISON (times per 2.5cm thickness ²)					
Rare	Single*	Fan Grill	4	225	7.5
Medium	Single*	Fan Grill	4	225	9.5
GRILLING					
CHICKEN	SHELVES	FUNCTION	SHELF POSITION	TEMP (°C)	TIME (MIN)
Boneless pieces	Single	Fan Grill	5	175-190	30-50
BEEF					
Steak, rare	Single	Grill	4	HI	8-10
Steak, medium	Single	Grill	4	HI	10-15
Burgers	Single	Grill	4	HI	12-15
Meatballs	Single	Grill	4	HI	12-15
LAMB					
Chops, medium	Single	Grill	4	HI	15-20
Chops, well done	Single	Grill	4	HI	20-25
PORK					
Chops, well done	Single	Grill	4	HI	15-20
Ham steak	Single	Grill	4	HI	15-20
Bacon	Single	Grill	4	HI	4-7
SAUSAGES	Single	Grill	5	HI	10-15
FISH					
Fillets	Single	Fan Grill	5	200-220	8-12
Whole	Single	Fan Grill	5	200-220	15-20

COOKING CHARTS

GRILLING	SHELVES	FUNCTION	SHELF POSITION (FULL OVENS)	TEMP (°C)	TIME (MIN)
VEGETABLES					
Sliced	Single	Grill	4	HI	8-12
BREAD					
Toast (10-15mm thick)	Single	Grill	5	HI	1-3

¹ Start at 220°C for 10 minutes, and lower to 160°C for further 50 minutes

² Brown in frying pan first

* If multiple shelves are required (eg roasting vegetables at the same time), use **FAN FORCED** and shelf positions 2 and 4.

CARE AND CLEANING

Manual cleaning

ALWAYS

- Before any manual cleaning or maintenance, first wait for the oven to cool down to a safe temperature to touch, then turn its power supply off at the wall.
- Read this cleaning guidance and the 'Safety and warnings' section before you start cleaning your oven.
- To prevent soiling from becoming 'baked on' and stubborn, we recommend removing any easy-to-reach spills, food or grease stains from the oven cavity enamel after each use.

NEVER

- Never use a steam cleaner.
- Never store flammable substances in the oven.
- Never use abrasive or harsh cleaners, cloths, scouring pads or steel wool. Some nylon scourers may also scratch. Check the label first.
- Never leave alkaline (salty spills) or acidic substances (such as lemon juice or vinegar) on the oven surfaces.
- Never use cleaning products with a chlorine or acidic base.

WHAT?	HOW?	IMPORTANT!
Control Panel	Take particular care when cleaning the control panel glass and screen. Only use a damp cloth with detergent.	Do not use any oven cleaners, harsh or abrasive cleaners, scouring pads, steel wool or sharp metal scrapers on the glass. These may scratch and damage the surface.
Dials	Clean with a solution of mild detergent and hot water, then wipe dry.	Do not use stainless steel or oven cleaner on the dials, as doing so may damage the coating.
Stainless steel strip/oven door handle	Clean with a solution of mild detergent and hot water, then wipe dry with a microfibre cloth. If necessary, use a suitable stainless steel cleaner and polish.	Always read the label to make sure that your stainless steel cleaner does not contain chlorine compounds as these are corrosive and may damage the appearance of your oven. Always rub the stainless steel in the direction of the grain.
Oven door frame and plastic corner clips	Clean with a solution of mild detergent and hot water, then wipe dry.	

CARE AND CLEANING

WHAT?	HOW?	IMPORTANT!
Oven cavity	<p>To clean light soiling off the enamelled surfaces:</p> <ul style="list-style-type: none"> • Wipe with a damp cloth and a solution of hot water and mild detergent or an ammonia-based cleaner. • Wipe dry with a soft cloth. 	<ul style="list-style-type: none"> • To prevent soiling from becoming 'baked on' and stubborn, we recommend removing any easy-to-reach spills, food or grease stains from the enamelled surfaces after each use. • To make wiping out the oven easier you may remove the oven door. See the following pages for more information.
Sliding shelf	Wipe with a damp cloth and mild detergent. Do not wipe off or wash away the white lubricating grease (visible when the shelf is extended).	Do not wash the shelf in the dishwasher, immerse in soapy water, or use oven cleaner on it. Doing so will prevent the slides from running smoothly.
Grid Grill rack Grill pan Wire oven shelves	Clean with a solution of mild detergent and hot water. Pre-soak stubborn burnt-on stains in a solution of dishwasher powder and hot water. These parts are also dishwasher safe.	
Oven seal	Do not clean this part.	
Oven door glass (after every use)	<p>Use a soft cloth and a mixture of warm water and dishwashing liquid to remove soiling after every use.</p> <p>For stubborn stains, try a mixture of baking soda and warm water with a non-abrasive scrubbing pad, then wipe dry with a soft, lint-free cloth.</p>	Do not use oven cleaners or any other harsh/abrasive cleaners, cloths, scouring pads, steel wool or sharp metal scrapers to clean the oven door glass. These scratch the glass, which in turn could result in the glass cracking and shattering. Do not allow grease to build up on the glass or become baked on as this reduces visibility into the oven.
Drip channel	Use a sponge to soak up any moisture that has collected in the drip channel, below the door.	

CARE AND CLEANING

Removing the side racks

Remove the side racks to make cleaning the oven easier.

Always turn the oven off at the wall first. Ensure the oven has cooled down completely before starting.

1

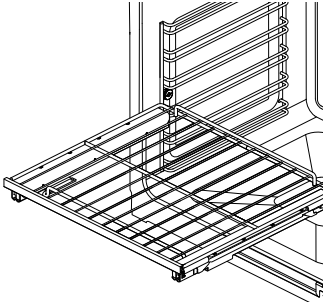

Slide out all shelves and remove.

2

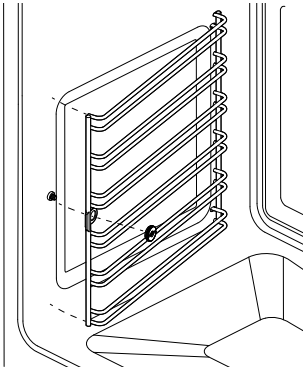

Unscrew and remove the fixing nut at the front of the side rack. Use a coin to loosen the nut if necessary.

Pull the front of the rack toward the back of the oven until the front tab is clear of the fixing nut.

3

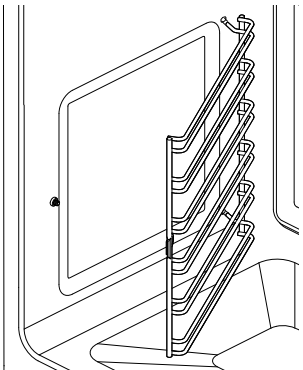

Slide the side rack forward until the rear prongs are clear of the holes.

CARE AND CLEANING

Refitting the side racks

1

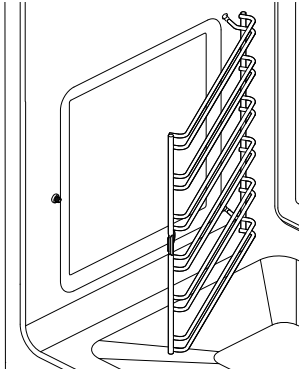

Slide the rear prongs of the side rack back into the holes, ensuring the rack is firmly pushed up against the side wall of the oven.

2

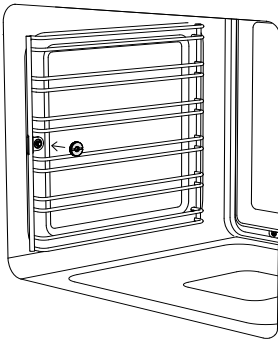

Fit the side rack front tab over the fixing screw.

Replace the fixing nut. You may use a coin to tighten the nut.

Drop down upper element

Always turn off the oven at the wall before lowering the upper element. Make sure the oven has cooled down completely before starting.

1

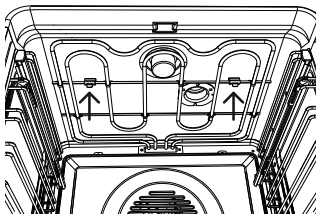

Pull the two securing clips gently forward to release the element. The element will now drop down to enable cleaning.

When you have finished cleaning the oven ceiling, pull the securing clips forward, raise the element and release the clips. Make sure the element is securely held in place. The element itself is self-cleaning.

CARE AND CLEANING

Replacing the oven light bulbs

- Your oven uses G9 halogen bulbs with the specifications 220-240V, 50Hz and 25W.
- Always hold the replacement bulb in a soft cloth. Touching the bulb will reduce its life-span.
- The light is located in the ceiling of the oven, center front.
- Oven bulb replacement is not covered by your warranty.

Changing the bulb

- ① Let the oven cavity and grill element cool down before changing the bulb.

Turn the oven off at the wall before continuing.

- ② Turning anti-clockwise unscrew the glass cover.
- ③ Carefully pull out the faulty halogen bulb.
- ④ Replace the light bulb
- ⑤ Replace the glass cover.
- ⑥ Turn the oven back on and set the clock, refer to 'First use'.

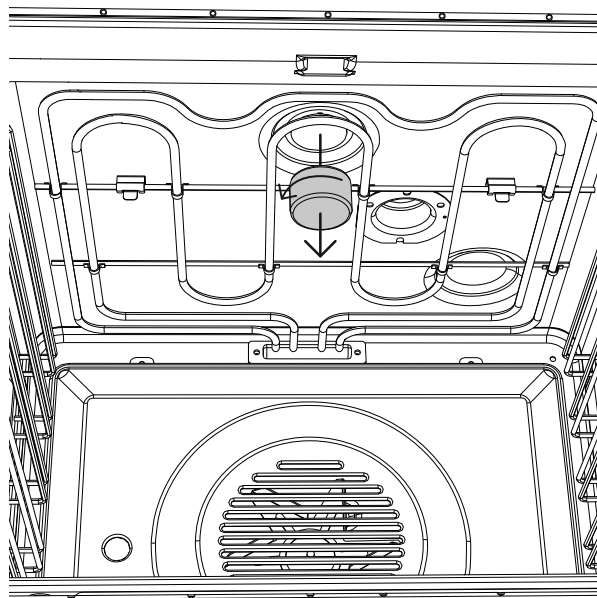

CARE AND CLEANING

Removing and refitting the oven door.

To remove the door

1

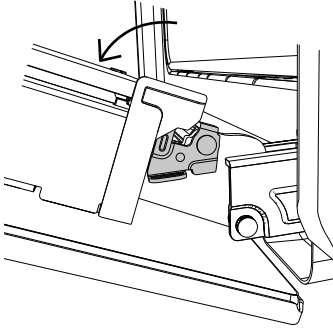

Take care, the oven door is heavy.

Open the door fully.

Locate the two small metal locking levers on both door hinges either side.

2

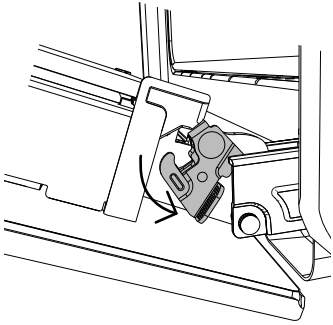

Push each locking lever down fully to release the door from the hinge.

3

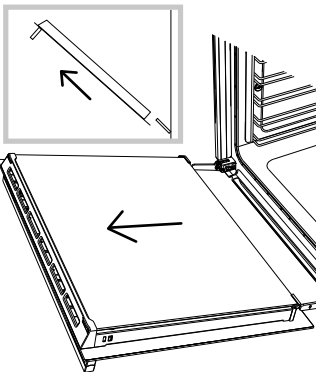

Holding the door on both sides, lift door back up to 45° and carefully pull the door out and away from the hinges.

CARE AND CLEANING

To refit the door

1

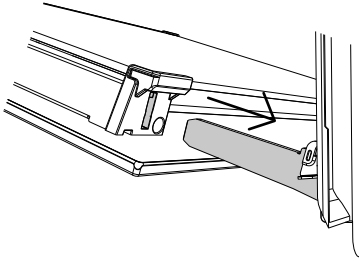

Holding the door on both sides, line up the holes in the base of the door with the hinges and slide the door on.

2

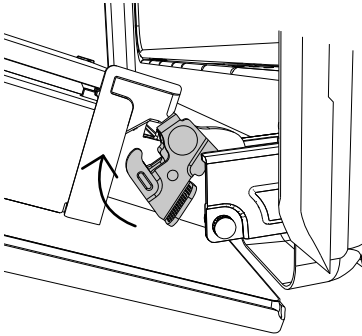

Ensure the door is firmly in place on the hinges. Open the door fully again and push each locking lever up to lock the door onto the hinge.

3

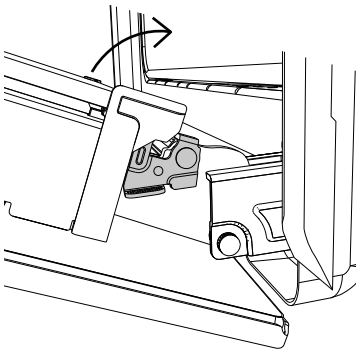

Ensure the levers are both fully locked before trying to shut the door.

CARE AND CLEANING

Removing the door glass panes for cleaning

The oven door is made up of 3 glass panes. To clean the middle pane you will first need to remove door and inner pane.

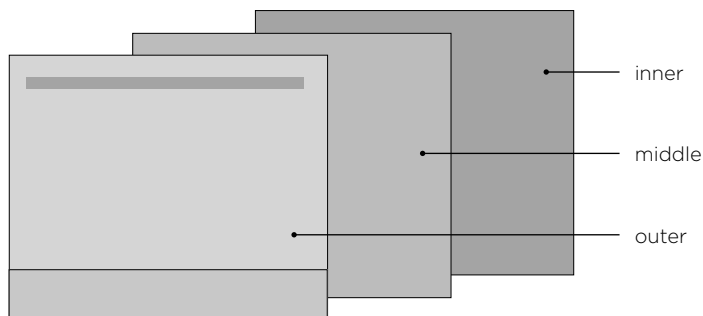

- Make sure you follow the precautions and guidance below very carefully. Replacing the glass panes and the door incorrectly may result in damage to the oven and could void your warranty.
- Take care, the oven door is heavy. If you have any doubts, do not attempt to remove the door.
- Make sure the oven and all its parts have cooled down. Do not attempt to handle the parts of a hot oven.
- Take extreme care when handling the glass panes. Avoid the corners and edges of the glass bumping against any surface. This may result in the glass shattering.
- Don't use oven cleaners or any other harsh/abrasive cleaners, cloths, scouring pads, steel wool or sharp metal scrapers to clean the glass surfaces. These scratch the glass and may damage its special coating, which in turn could result in the glass cracking or shattering.
- If you notice any sign of damage on any of the glass panes (such as chipping or cracks), do not use the oven. Contact a Fisher & Paykel trained and supported service technician or Customer Care.
- Ensure you replace all the glass panes correctly. Do not use the oven without all glass panes correctly in place.
- If the glass panes feel difficult to remove or replace, do not force them. Contact a Fisher & Paykel trained and supported service technician or Customer Care.

Service visits providing assistance with using or maintaining the oven are not covered by your warranty.

We recommend removing the door to make cleaning the glass easier. Refer to 'Removing and refitting the oven door' for details. Once the door is removed, lay it down on a soft, clean, flat surface.

CARE AND CLEANING

To remove the inner pane

①

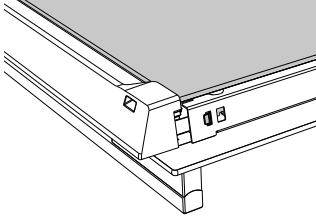

Push the glass retainer tabs in on both sides of the door. Pull the glass retainer up until the tabs relocate in the uppermost hole.

②

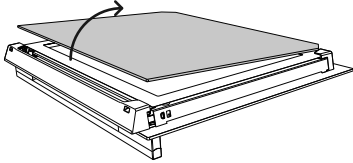

Holding the top of the inner pane, gently pull the pane toward the top of the door until the pane is clear of the notch at the bottom of the door and lift out. Do not angle the pane too much as you may damage the glass.

To remove the middle pane

①

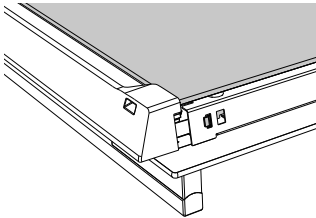

Push the glass retainer tabs in on both sides of the door again. The glass retainer can then be pulled off completely.

②

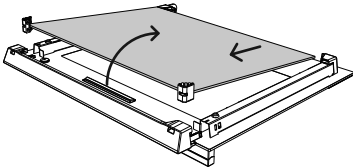

Gently pull the middle pane toward the top of the door until the pane is clear of the notch at the bottom of the door. Lift the pane out. The rubber stoppers at the top of the pane remain attached to the glass pane.

CARE AND CLEANING

When replacing the glass panes ensure that:

- you replace the inner pane correctly as shown to ensure that the oven operates safely
- you take extra care not to bump the edges of the glass against any object or surface
- you do not force any of the panes into place. If you are experiencing difficulties replacing the panes, remove and start the process again. If this does not help, call Customer Care.

Replace the middle pane

Ensure the pane is located correctly as detailed in the steps below. The pane is symmetrical and does not have a front or back.

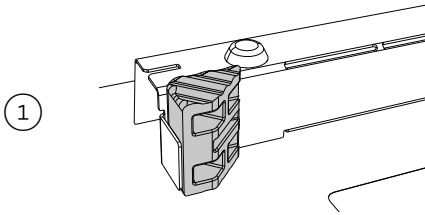

Ensure the rubber stoppers are still attached at the top of the pane. Ensure they are positioned correctly on the glass with the longer side running down the side of the glass pane.

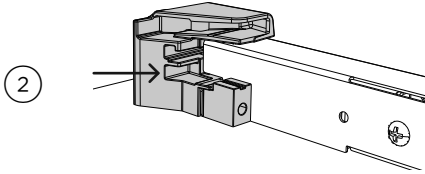

Slot the bottom of the pane into the lower notch at the bottom of the door.

Lower the pane into the door, the rubber stoppers rest on the outer pane of glass.

Replace the inner pane

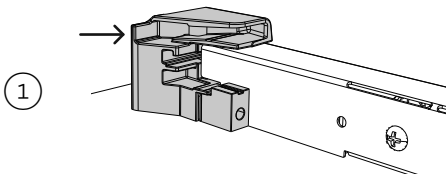

Slide the pane into the notch at the bottom of the door and lower the pane onto the notch at the top of the door.

Slide the glass retainer back into place and ensure it is clipped securely in place.

Ensure the glass retainer is correctly and firmly in place and the glass pane is secure.

PARTS AND ACCESSORIES

ITEM	REFERENCE NUMBER
Bulb spares kit OB60C	563377

TROUBLESHOOTING

If there is a problem with your oven, please check the following points before contacting your local Fisher & Paykel trained and supported service technician or the Customer Care Centre.

General

PROBLEM	POSSIBLE CAUSES	WHAT TO DO
The oven does not work	No power	Check that the mains power supply (wall switch) is turned on, the fuse has not tripped and there is no power outage in your area.
	The clock has not been set.	The oven will not function until the clock is set. Refer to 'First use' for guidance on setting the clock.
The oven does not work but the display is lit.	The oven is set for automatic cooking.	Refer to 'Automatic cooking' for details.
The oven light does not come on when I select a function.	The clock has not been set.	The oven will not function until the clock is set. Refer to 'First use' for guidance on setting the clock.
	The oven light bulb has blown.	Replace the light bulb, refer to 'Care and cleaning'.
The light does not come on when I open the oven door.	This is normal.	The oven light only comes on when you have selected a cooking function.
The oven is not heating.	The door is not properly closed or it is opened too frequently during cooking.	The heating elements are disabled while the door is open. Ensure the door is properly closed and avoid opening it frequently during cooking.
	The clock has not been set.	The oven will not function until the clock is set. Refer to 'First use' for guidance on setting the clock.
A glass pane in the oven door has cracked, chipped, or shattered.	Incorrect cleaning or the edge of the glass hitting against something.	You must NOT use the oven. Contact a Fisher & Paykel trained and supported service technician or Customer Care
The fan turns on again several minutes after I have turned off the oven.	This is normal.	If the oven is over a certain temperature the cooling fan will automatically turn on to cool the oven down.

TROUBLESHOOTING

General

PROBLEM	POSSIBLE CAUSES	WHAT TO DO
The oven fan stays on when I set a delayed start with automatic cooking	This is normal.	The oven will not heat up until the start time is reached.
The oven cancels automatic cooking when I adjust the clock setting.	The oven was set for automatic cooking when you were trying to adjust the clock setting.	You can only adjust the clock setting while the oven is not set for automatic cooking, refer to 'First use'.

WARRANTY AND SERVICE

This oven has been designed and constructed in accordance with the following codes and specifications:

New Zealand and Australia

- AS/NZS 60335-1 General Requirements for Domestic electrical appliances
- AS/NZS 60335-2-6 Particular Requirements for Domestic electrical cooking appliances
- AS/NZS CISPR 14.1 2010 Electromagnetic Compatibility Requirements.

FISHERPAYKEL.COM

© Fisher & Paykel Appliances 2020. All rights reserved.

The models shown in this guide may not be available in all markets
and are subject to change at any time.

The product specifications in this guide apply to the specific products and
models described at the date of issue. Under our policy of continuous product
improvement, these specifications may change at any time.

For current details about model and specification availability in your country,
please go to our website or contact your local Fisher & Paykel dealer.

866260A 09.20