

FISHER & PAYKEL

BUILT-IN OVEN

OB24 Single models

USER GUIDE

US CA

CONTENTS

Safety and warnings	2
Introduction	7
First Use	8
Using the Timer	14
Cooking guide	15
Oven functions	18
Cooking charts	24
Automatic cooking	30
Using the Meat Probe (some models only)	32
User preference settings	34
Sabbath setting	38
Care and cleaning	40
Using the Self Clean function (some models only)	49
Trouble shooting	52
Alert codes	55
Warranty and service	57

IMPORTANT! **SAVE THESE INSTRUCTIONS**

The models shown in this user guide may not be available in all markets and are subject to change at any time. For current details about model and specification availability in your country, please go to our website www.fisherpaykel.com or contact your local Fisher & Paykel dealer.

SAFETY AND WARNINGS

Your oven has been carefully designed to operate safely during normal cooking procedures. Please keep the following safety instructions in mind when you are using it:

WARNING!



Electrical Shock Hazard

**Turn the oven off at the wall before replacing the oven lamp.
Failure to follow this advice may result in electrical shock or death.**

WARNING!



Fire Hazard

Follow the instructions on starting a Self Clean cycle carefully. Items made from combustible materials (for example: wood, fabric, plastic) may catch fire if left in the oven during a Self Clean cycle.

Do not place aluminium foil, dishes, trays, water or ice on the oven floor during cooking, as doing so will irreversibly damage the enamel; lining the oven with aluminium foil may even cause fire.

Never use your appliance for warming or heating the room. Persons could be burned or injured or a fire could start.

Storage in or on appliance: flammable materials should not be stored in an oven or near its surface.

Failure to follow this advice may result in overheating, burning, and injury.

WARNING!



Hot Surface Hazard

Accessible parts may become hot when in use.

To avoid burns and scalds, keep children away.

Use oven mitts or other protection when handling hot surfaces such as oven shelves or dishes.

Use care when opening the oven door.

Let hot air or steam escape before removing or replacing food.

Do not touch heating elements or interior surfaces of the oven. Heating elements may be hot even though they are dark in color. Interior surfaces of an oven become hot enough to cause burns. During and after use, do not touch, or let clothing or other flammable materials contact heating elements or interior surfaces of the oven until they have had sufficient time to cool.

Other surfaces of the appliance may become hot enough to cause burns — among these surfaces are the oven vent, the surface near the oven vent, and the oven door.

Failure to follow this advice could result in burns and scalds.

WARNING!



Cut Hazard

Take care — some edges are sharp.

Failure to use caution could result in injury or cuts.

IMPORTANT SAFETY INSTRUCTIONS!

To reduce the risk of fire, electrical shock, injury to persons or damage when using the oven, follow the important safety instructions listed below:

- Read all the instructions before using the oven. Use the oven only for its intended purpose as described in these instructions.
- Proper installation: be sure your appliance is properly installed and earthed by a qualified technician.
- Isolating switch: make sure this oven is connected to a circuit which incorporates an isolating switch providing full disconnection from the power supply.
- Household appliances are not intended to be played with by children.
- Do not leave children alone. Children should not be left alone or unattended in the area where the appliance is in use. They should never be allowed to sit or stand on any part of the appliance.
- Children of less than 8 years old must be kept away from the appliance unless continuously supervised. This appliance can be used by children aged from 8 years and above, and persons with reduced physical, sensory or mental capabilities or lack of experience and knowledge, if they have been given supervision or instruction concerning the use of the appliance in a safe way and they understand the hazards involved. Cleaning and user maintenance shall not be done by children without supervision.
- Do not place heavy objects on the oven door.
- Wear proper apparel. Do not wear loose fitting or hanging garments when using the appliance. They could ignite or melt if they touch an element or hot surface and you could be burned.

IMPORTANT SAFETY INSTRUCTIONS!

- **User servicing:** do not repair or replace any part of the appliance unless specifically recommended in the manual. All other servicing should be referred to a qualified technician.
- Do not use water on grease fires. Smother the fire or flame or use a dry chemical or foam type extinguisher.
- Use only dry oven mitts or potholders. Moist or damp potholders on hot surfaces could result in burns from steam. Do not let potholders touch hot areas or heating elements. Do not use a towel or a bulky cloth for a potholder. It could catch fire.
- Do not heat unopened food containers. They can build up pressure that may cause the container to burst and result in injury.
- **Safe food handling:** leave food in the oven for as short a time as possible before and after cooking. This is to avoid contamination by organisms which may cause food poisoning. Take particular care during warm weather.
- Always keep oven vents unobstructed.
- Do not operate your appliance by means of an external timer or separate remote control system.
- **Caution:** Hot air can blow from the vent at the base of the oven as part of the oven's cooling system.
- **Placement of oven shelves:** always position shelves in the desired location while the oven is cool (before preheating). If a shelf must be removed while the oven is hot, do not let the oven mitts or potholder contact hot heating elements in the oven or the base of the oven.
- Do not clean the oven seal or use any oven-cleaning products on it. It is essential for a good seal, which ensures that the oven operates efficiently. Care should be taken not to rub, damage or move it.
- Do not use oven cleaners, harsh/abrasive cleaning agents, waxes, or polishes. No commercial oven cleaner, oven liner, or protective coating of any kind should be used in or around any part of the oven. Do not use harsh/abrasive cleaners, scourers or sharp metal scrapers to clean the oven door glass since they scratch the surface, which may result in the glass shattering.
- Clean only the parts listed in this manual.
- Do not use a steam cleaner to clean any part of the oven.

IMPORTANT SAFETY INSTRUCTIONS!

- **Before starting a Self Clean cycle (some models only) remove oven shelves and all other cookware/utensils, and wipe up large food spills or grease deposits.**
- **Before starting a Self Clean cycle (some models only) make sure you move any pet birds to another, closed and well-ventilated room. Some pet birds are extremely sensitive to the fumes given off during a Self Clean cycle and may die if left in the same room as the oven during such a cycle.**
- **During a Self Clean cycle (some models only) the oven reaches higher temperatures than it does for cooking. Under such conditions, the surfaces may get hotter than usual and children should be kept away.**
- **Do not store things children might want above the oven. Children could be burned or injured while climbing on the oven to retrieve items.**
- **Do not install or operate the appliance if it is damaged or not working properly. If you receive a damaged product, contact your dealer or installer immediately.**
- **Use only bakeware approved for oven use. Follow the bakeware manufacturer's instructions.**
- **The California Safe Drinking Water and Toxic Enforcement Act requires businesses to warn customers of potential exposure to substances which are known by the State of California to cause cancer or reproductive harm. Small amounts of harmful chemicals are given off in the oven' self-cleaning cycle from insulation and food decomposition. Significant exposure to these substances can cause cancer and reproductive harm. Venting with a hood or open window, and wiping out excess food spills prior to self cleaning the oven reduces exposure.**

INTRODUCTION

Congratulations on your new purchase. Your Fisher & Paykel oven has a number of features to make cooking a great experience for you:

- a wide choice of oven functions
- intuitive controls and displays

Before you start

- Make sure the installer has completed the 'Final checklist' in the Installation instructions.
- Read this guide, taking special note of the 'Safety and warnings' section.
- Remove all internal and external packaging and dispose of it responsibly. Recycle items that you can.
- Refit the shelves at your desired position in the oven.
- We recommend you then condition the oven, using the instructions following.

Note: Not all accessories are provided with all models. To purchase other accessories, contact your nearest Fisher & Paykel Service Center, Customer Care or visit our local website listed on the back cover.

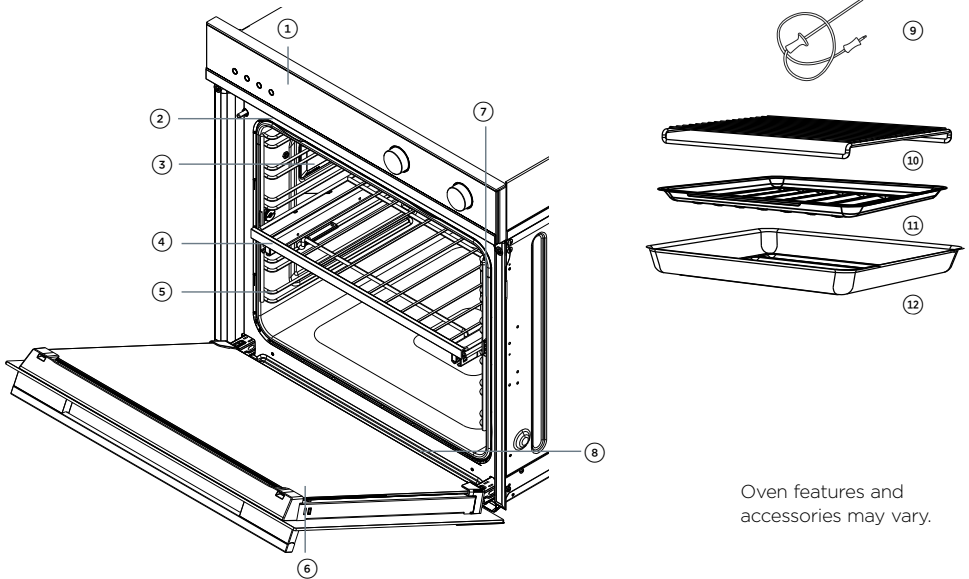

Oven features and accessories may vary.

- ① Control panel
- ② Oven vent louvres
- ③ Oven light
- ④ Full extension sliding shelf (some models only)
- ⑤ Side rack
- ⑥ Oven door and handle
- ⑦ Oven seal
- ⑧ Drip channel

Accessories:

- ⑨ Meat probe (some models only)
- ⑩ Broil rack (some models only)
- ⑪ Grid (some models only)
- ⑫ Broil pan

Not Shown:

- Flat wire shelf (some models only)
- Step down wire shelf

FIRST USE

- Your oven comes with two shelves positioned and secured inside.
- The following shows you how to remove and reposition the shelves to your preferred position.
 - We recommend you then condition the oven.

Remove all cable ties and packaging holding the shelving in place

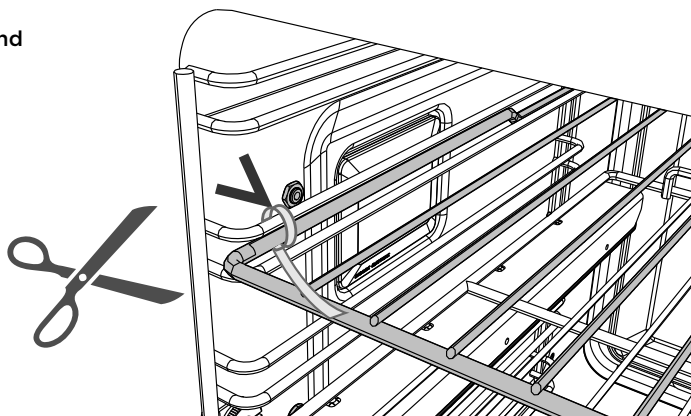

Remove shelves from the oven

- ① Remove all the shelving, taking special care with the sliding shelf (some models only).
- ② To remove a sliding shelf, grip it at the front (making sure you are gripping the wire shelf and the sliding frame together), lift upwards and pull it out of the oven.

For your safety, the wire shelves and sliding frames are built together as one unit and are not separable. When placed properly on the side racks, the slides will prevent the wire shelves from tilting when pulled towards you.

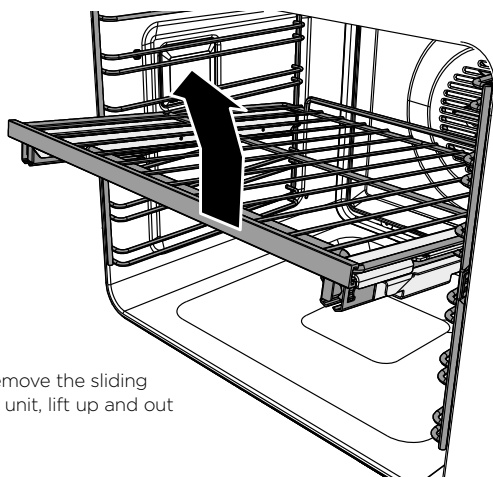

To remove the sliding shelf unit, lift up and out

FIRST USE

Replace shelving in your preferred positions

To replace a wire shelf:

- Check the guard rail (as shown) to make sure the shelf is the right way up.
- Slide it horizontally back along the side racks ensuring it is level and the stop notch is facing down.

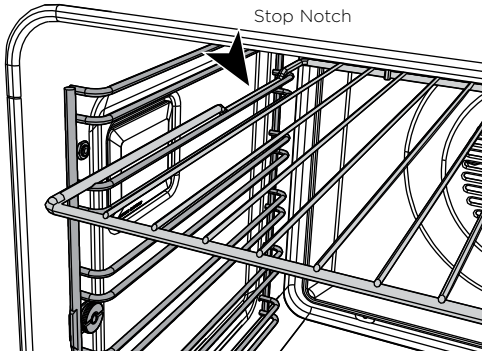

Replacing a wire shelf

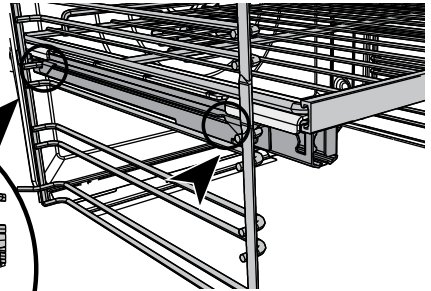
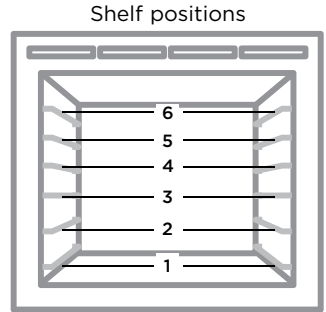
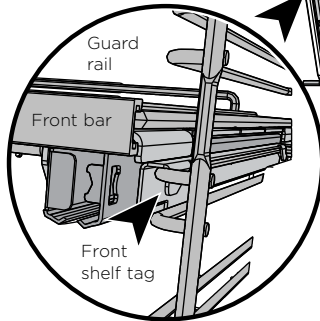

Replacing a sliding shelf

To replace a full extension sliding shelf (some models only)

- Position the shelf so that it is level, with the front bar toward you (as shown).
- Check the guard rail (as shown) to ensure the shelf is the right way up.
- Ensure the sliding frame is not extended.
- Position the shelf on top of the side racks, so the rear shelf tag at the back of the sliding frame rests behind the side rack wire (as shown).

IMPORTANT!

Ensure the sliding shelf is positioned on top of the side rack wires rather than between them.

- Push the sliding shelf all the way to the back of the oven, until the front shelf tag drops into place behind the side rack wire.

We recommend placing the telescopic sliding shelf on position 2 or 4.

To prevent the tags from lifting off the side racks, take care to slide the shelves forward horizontally.

FIRST USE – THE CONTROL PANEL

Illustrative purposes only – oven function indicators may vary.

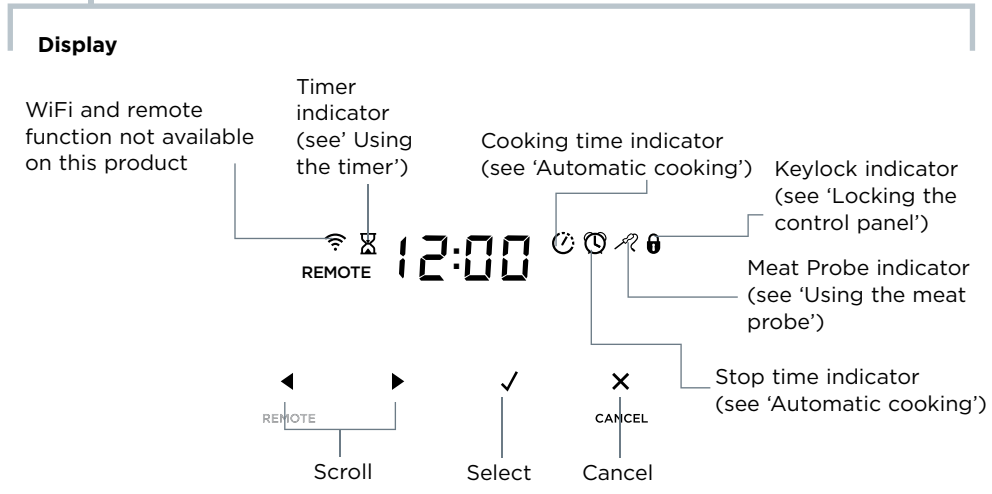
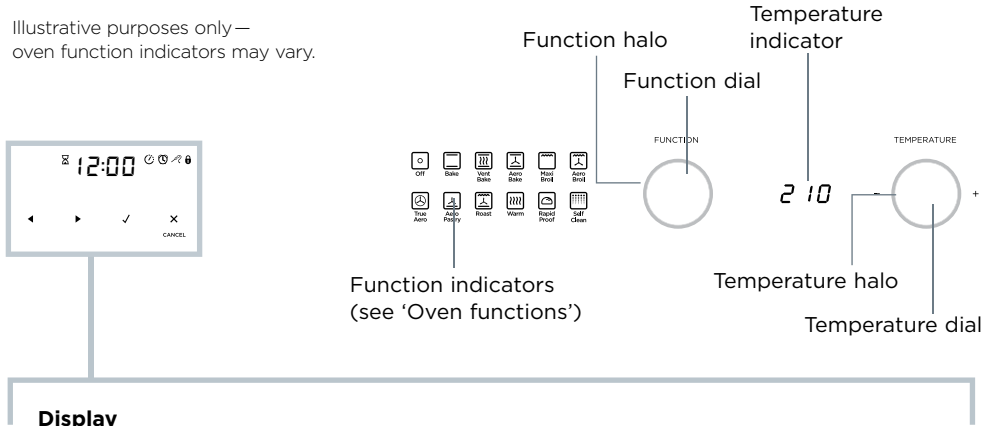

Using the touch controls

- Use the ball of your finger, not its tip. The controls respond to touch, so you don't need to apply any pressure.



Locking the control panel

This function is to prevent accidental use of the oven (eg by children). When locked the controls are unresponsive and the oven will not turn on.

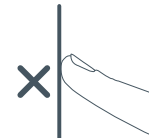

To lock:

Touch and hold the select ✓ control until the indicator light comes on.

To unlock:

Touch and hold the cancel × control.

FIRST USE

Setting the Clock

When your oven is first turned on, or after a power cut, the display will flash . You will need to set the clock in order to use the oven.



24: Hr

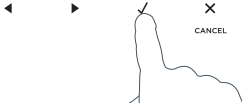

- ① The display will flash 24 Hr



12: Hr

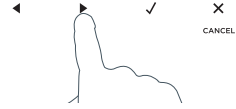

- ② Touch the right scroll ► control to scroll between 24 Hr and 12 Hr
- ③ Touch the select ✓ control to confirm.



10: 13

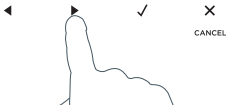

- ④ Touch the left and right scroll ◀ ▶ controls to set the time.



10: 13

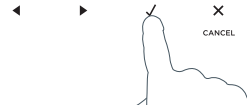

- ⑤ Touch the select ✓ control to confirm.
- The time set will now be steadily lit.

Changing the time

You set the clock within the user preference menu.

24: Hr

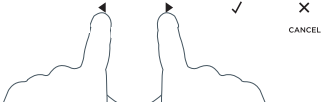

12: Hr

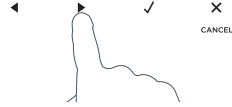

- ① To enter the user preference menu touch and hold the left and right scroll ◀ ▶ controls together for 3 seconds.
 - Either 12 Hr or 24 Hr will be displayed.
- ② Touch the select ✓ control to confirm. The display will flash.

- ③ Touch the right scroll ▶ control to scroll between 24 Hr, 12 Hr or OFF to turn the display off (see 'Setting User preferences' for more information).
- ④ Touch the select ✓ control to confirm.

10: 13

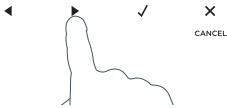

- ⑤ Touch the left and right scroll ◀ ▶ controls to set the time.
- ⑥ Touch the select ✓ control to confirm.

FIRST USE

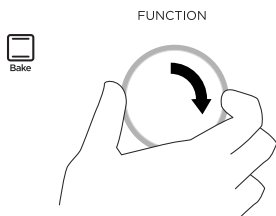

① Select the Bake  function.

- The halo will glow white.
- Each function has a preset temperature and so the oven will start heating at the Bake preset temperature of 360°F (180°C).

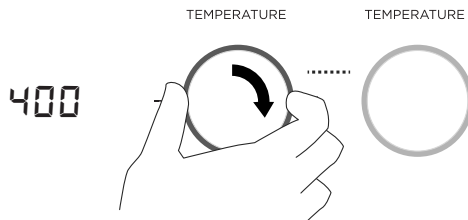

② Set the temperature to 400°F (200°C) for 30 minutes.

- While the oven is heating up, the temperature halo will glow red and the temperature indicator will alternately show the actual and set temperatures.
- When the oven has reached set temperature, a tone will sound and the halo will turn white.

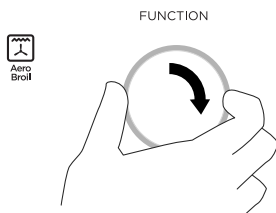

③ After 30 minutes is up, select the Aero Broil  function.

④ Leave the temperature at 400°F (200°C) for 5 minutes.

- The halo will remain white.

⑤ Now select the True Aero  Function. Leave the temperature at 400°F (200°C) for 20 minutes.

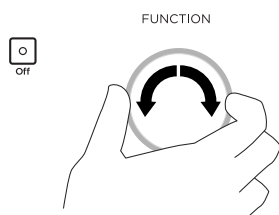

⑥ When you have finished, turn the function dial to Off . The halos will go out.

- There will be a distinctive smell and a small amount of smoke during the conditioning process as manufacturing residue is burnt off. This is normal, but make sure the kitchen is well ventilated during the conditioning.
- Once cooled, wipe out the oven with a damp cloth and mild detergent, and dry thoroughly.



USING THE TIMER

- You can use the timer at any time, even if you are not using the oven.
- The timer counts down in minutes (hr:min) until the last hour of cooking when it will countdown in seconds (min:sec).
- You can set the timer for up to 23 hours 59 minutes.

IMPORTANT!

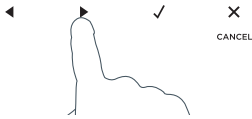
The timer does NOT turn the oven off.



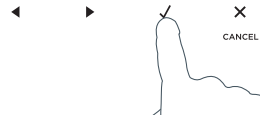

- ① Select the timer  by touching the right scroll  control once.
 - The timer  indicator will appear and the colon will flash.



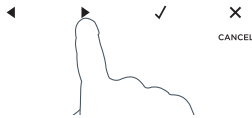

- ② Touch the select  control to confirm.
 - The display will flash to indicate the timer is ready to be set.



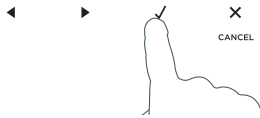



- ③ Set the time by touching the scroll   controls.
 - Holding the controls down will speed up the scrolling.





- ④ Touch the select  control to confirm.
 - The timer will then begin to count down.
 - If you want to check the time of day, touch the cancel  control once. Touch the right scroll  control to scroll back to the timer.

To modify the timer setting

- ① Make sure the display shows the remaining time counting down.
- ② Touch the select  control.
- ③ Touch the scroll   controls to set a new time.
- ④ Touch the select  control to confirm.

To cancel the timer setting

- ① Make sure the display shows the remaining time counting down.
- ② Touch the cancel  control until the display shows the time of day and the timer  indicator disappears.

When the set time is up

- The display will show  and a tone will sound every few seconds.
- Touch any control to stop the tone sounding. The display will revert to showing the time of day.

COOKING GUIDE

General guidelines

This oven has been designed to utilise its four elements and rear fan in differing combinations to provide you with enhanced performance and a wide range of functions, allowing you to cook all types of food to perfection.

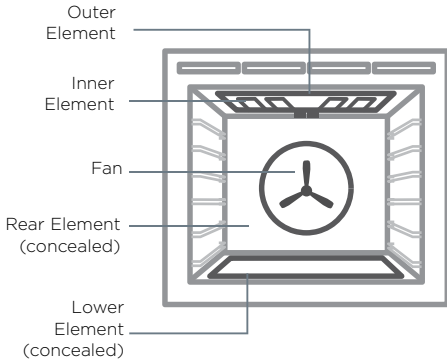

Shelf positions—Full size ovens

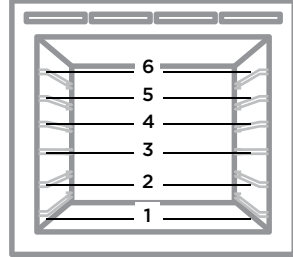

BAKING

- For best results when baking, always pre heat your oven. The temperature halo will change from red to white when the pre-set temperature is reached.
- While the oven is heating the broil element will be on.
- We advise you do not open the door until at least 3/4 of the way through cooking.
- Make sure cake pans do not touch each other or the sides of the oven.
- When baking double the recipe (especially cookies) cook time may need to increase.
- Your cookware will influence baking times. Dark pans absorb the heat more quickly than reflective pans; glass cookware may require a lower temperature
- Multi-shelf baking may also require a slight increase in cooking time.

Shelf Position Guide

- Single shelf: Place your baking on a shelf that will have the top of your pan near the center of the oven cavity.
- Multi shelf: Always leave a space between shelves to allow the air to circulate.

COOKING GUIDE

ROASTING

- The Roast function is designed to brown the outside of the meat but still keep the inside moist and juicy.
- Boneless, rolled or stuffed roasts take longer than roasts containing bones.
- Poultry should be well cooked with the juices running clear and an internal temperature of 165°F (75°C).
- If using a roasting bag, do not use the Roast function. The initial searing stage is too hot for roasting bags. Use Fan Bake or Fan Forced and follow the manufacturer's instructions.
- When using the Roast function, do not cover your roast, as this will stop the searing process browning the outside of the meat. If you prefer to roast in a covered pan, use the Fan Bake function instead and increase the temperature by 70°F (20°C).
- Cook larger cuts of meat at a lower temperature for a longer time. The meat will cook more evenly.
- Always roast meat fat side up. That way, basting may not be required.
- Always rest the meat for at least 10 minutes after roasting to allow the juices to settle. Remember the meat will continue to cook for a few minutes after removing it from the oven.
- Try our new Vent Bake function as an alternative for roasting pork. The drier atmosphere will help to perfect your crackling.

Shelf Position Guide

Place the meat on a shelf so that the meat is in the center of the oven or lower.

BROILING

- This is a healthier alternative to frying.
- Always broil with the oven door completely shut.
- If you use glass or ceramic pans, be sure they can withstand the high temperatures of the broil.
- To avoid piercing the meat and letting juices escape, use tongs or a spatula to turn the meat halfway through cooking.
- Brush meat with a little oil to help keep the meat moist during cooking. Alternatively marinate the meat before broiling (but be aware that some marinades may burn easily).
- Where possible broil cuts of meat of a similar thickness at the same time. This will ensure even cooking.
- Always keep a close watch on your food while broiling to avoid charring or burning.

Shelf Position Guide

- For thinner cuts of meat, toasting or browning foods, use a higher shelf position.
- Thicker cuts of meats should be broiled on lower shelves or at a lower broil setting to ensure even cooking.

COOKING GUIDE

REHEATING

- Use Bake, Fan Bake or Vent Bake to reheat food.
- Bake and Vent Bake are particularly good for reheating pastry based items, as the base heat will help re-crisp the pastry case.
- Always reheat food to piping hot. This reduces the risk of contamination by harmful bacteria.
- Once hot, use the Warm function to keep the food warm.

Never reheat a food more than once.

Drip Channel

Any condensation that is formed during the cooking process will collect in the drip channel. This can be wiped out using a sponge once the oven has cooled.

OVEN FUNCTIONS

IMPORTANT!

- Depending on your model, you may only have some of these functions.
- Use all the functions with the oven door closed.



Bake

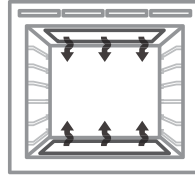

upper outer and lower elements

- Heat comes from both the upper and lower elements. The fan is not used in this function.
- Ideal for cakes and foods that require baking for a long time or at low temperatures.
- This function is not suitable for multi-shelf cooking.

Ideal for moist foods that take a longer time to cook eg rich fruit cake, or bread in combination with Vent Bake.



Vent Bake
(some models only)

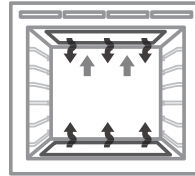

upper outer and lower elements with additional venting

- Heat is produced by the upper and lower elements and additional oven venting is used to remove excess moisture, reducing the formation of steam and condensation.
- Vented baking allows the moisture content of the oven to be reduced, without compromising the temperature.
- The venting system results in gentle air movement without the need to use a fan.
- It provides gentle browning without the 'drying out' effect of a fan.
- Reducing the formation of condensation means it is perfect way to slow cook meat dishes.
- You may switch from Bake to Vent Bake for foods that like a moist (steamy) start to the cooking process and then benefit from a drier finish (such as bread).
- Use Vent Bake at a low temperature 120°F (50°C) for drying fruit, vegetables and herbs.

Ideal for foods such as:

- meringues
- Yorkshire pudding
- finishing off choux pastry, croissants, breads
- slow cooked meat dishes
- poached foods (fish, chicken)
- dishes where initial crisping of the outside is desired (eg pork belly)

OVEN FUNCTIONS



Aero Bake

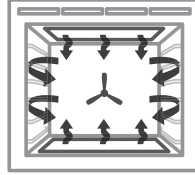

fan plus upper outer and lower elements

- The oven fan circulates hot air from the top outer and the lower elements and distributes it around the oven cavity.
- Food cooked tends to brown more quickly than foods cooked on the traditional Bake function.
- You may need to decrease the time from that recommended in traditional recipes.

Ideal for single shelf baking that takes less than an hour to cook - foods such as muffins, biscuits and cupcakes or things like enchiladas.



Maxi Broil

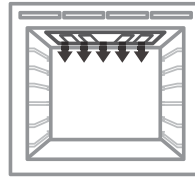

upper inner and outer elements

- Intense radiant heat is delivered from both top elements. There are 9 steps between 'Lo' and 'Hi' (100% power).
- Preheating is not essential although some people prefer to allow the element to heat for a few minutes before they place food under the broil.
- The temperature halo will remain red while using the broil function.
- The most suitable function for 'finishing off' many meals, for example browning the top of potato gratin and frittata.

Ideal for toasting bread or for top browning to 'finish off dishes'.

OVEN FUNCTIONS



Aero Broil
(some models only)

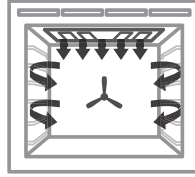

fan plus upper inner and outer elements

- This function uses the intense heat from the elements for top browning and the fan to ensure even cooking of foods.
- Meat, poultry and vegetables cook beautifully; food is crisp and brown on the outside while the inside remains moist and tender.

Ideal for whole chicken, tenderloin of beef or broiling your favourite chicken, fish or steak.



True Aero

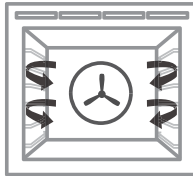

fan and rear element

- By using the central rear heating element and fan, hot air is blown into the cavity, providing a consistent temperature at all levels, making it perfect for multi-shelf cooking.
- Trays of cookies cooked on different shelves are crisp on the outside and chewy in the middle.
- Meat and poultry are deliciously browned and sizzling while remaining juicy and tender.
- Casseroles are cooked to perfection and reheating is quick and efficient.
- When multi-shelf cooking it is important to leave a gap between trays (eg use shelves 3 & 5) to allow the air to move freely. This enables the browning of foods on the lower tray.
- If converting a recipe from Bake to True Aero, we recommend that you decrease the bake time or decrease the temperature by approximately 70°F (20°C).
- For items with longer bake times (eg over an hour) it may be necessary to decrease both time and temperature.

Ideal for multi-shelf cooking biscuits, cookies, scones, muffins and cupcakes.

OVEN FUNCTIONS



Aero Pastry
(some models only)

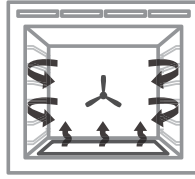

fan plus lower element

- The fan circulates heat from the lower element throughout the oven.
- Excellent for cooking pizza as it crisps the base beautifully without overcooking the topping.

Ideal for foods such as sweet and savoury pastry foods and delicate foods that require some top browning eg frittata, quiche.



Roast
(some models only)

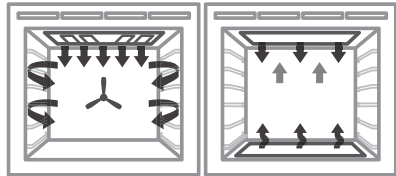

fan plus upper and lower elements

- A two-step program. An initial 20 minute searing stage crisps and browns the roast and caramelises the outside of the meat, then the temperature drops to the level you have preset for the remainder of the cooking period, producing a tender and juicy roast that is full of flavor.
- Oven does not require preheating.
- If desired, use the broil rack or grid, or place vegetables under the roast to allow the juices to drain away from your meat. This will allow the hot air to circulate under the meat as well.

Ideal for Roasting meat, chicken and vegetables.

OVEN FUNCTIONS



Classic Bake
(some models only)

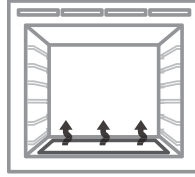

lower element only

- Heat comes from the lower element only, the fan is not used.
- This is the traditional baking function, suitable for recipes that were developed in older ovens.
- Bake on only one shelf at a time.

Ideal for foods that require delicate baking and have a pastry base, like custard tarts, pies, quiches and cheesecake or anything that does not require direct heat and browning on the top.

OVEN FUNCTIONS



Warm

(some models only)

this is not a cooking function

- Provides a constant low heat of less than 195°F (90°C).
- Use to keep cooked food hot, or to warm plates and serving dishes. To reheat food from cold, use another oven function to heat the food piping hot and only then change to Warm, as this function alone will not bring cold food up to a high enough temperature to kill any harmful bacteria.



Rapid Proof

(some models only)

this is not a cooking function

- Gentle heat is generated from the upper and lower elements
- Provides the optimum warm and draft-free environment for proving yeast dough.
- This method provides a faster proof time than at room temperature.
- To prevent overproofing we recommend you check the dough every 30mins.

Proving dough

- ① Place dough in a lightly oiled bowl and cover with plastic wrap and/or a clean damp cloth
- ② Position the bowl in the center of the oven
- ③ Select Rapid Proof function



Self Clean

(some models only)

this is not a cooking function

- The Self Clean cycle takes care of the mess and grime that is traditionally associated with oven cleaning.
- There are two Self-Clean cycles available:
 - Self clean (which takes a minimum of 4 hours) for normal cleaning and
 - Light self-clean (which takes a minimum of 3 hours) for lightly soiled ovens
- Always clean the inner door glass pane first.
- See 'Using the Self Clean function' for details.

COOKING CHARTS

- Shelf positions are counted from the base up (1 is the lowest, 6 (full size ovens) or 4 (compact ovens) is the highest). Position shelves before you turn the oven on.
- For best results preheat the oven to the required temperature.
- The broil element may come on while the oven is heating up.
- The halo on the temperature dial will change from red to white when the oven has reached the selected temperature. The display will only show the set temperature once the oven has finished preheating. The halo may change between white and red as the oven maintains its set temperature.
- Note: oven accessories may temporarily deform slightly when they become hot. This is normal and does not affect their function.

BAKING

FOOD	SHELVES	
Biscuits	Plain	Single
		Multi
	Chewy choc chip	Single
		Multi
	Sugar Cookies	Single
	Multi	
Cakes	Pound Cake	Single
	Chocolate Brownie (8"x8"/20x20cm pan)	Single
	Angel Food Cake (10"x4"/25x10cm tube pan)	Single
	Rich Fruit Cake	Single
	Sponge (single large)	Single
	Sponge (2x20cm)	Single
Muffins / Cupcakes	Cupcakes	Single
		Multi
	Muffins	Single
	Multi	
Scones	English Scones	Single
Meringues	Meringues	Single
Bread/Bread Rolls	Sandwich Loaf - 9"x5"/23x13cm Loaf Pan	Single
	Wholewheat Loaf - 9"x5"/23x13cm Loaf Pan	Single
	Soft Dinner Rolls	Single
	Dough Proof	Single
Pastry	Pastry Shell (baked blind)	Single
	Phyllo	Single
	Flaky / Puff	Single
	Choux	Single
		Multi
	Croissants	Single
	Multi	
Pies	Fruit Pie (2 crust)	Single
	Baked Cheesecake (in water bath)	Single
	Pumpkin Pie (blind bake, then add filling)	Single
	English Custard Tart (blind bake, then add filling)	Single
Dessert	Crème Brulee (in water bath)	Single
	Crème Caramel (in water bath)	Single

COOKING CHARTS

The information in these charts are guidelines only. Refer to your recipe or the packaging and be prepared to adjust the cooking times and settings accordingly.

RECOMMENDED FUNCTION	SHELF POSITIONS	TEMP (°F)	TEMP (°C)	TIME (MINS)
Aero Bake	3	400 - 425	210 - 220	8 - 10
True Aero	2 & 4	425 - 450	215 - 230	10 - 12
Aero Bake	3	355 - 375	180 - 190	10 - 15
True Aero	2 & 4	325 - 340	160 - 170	10 - 15
Aero Bake	3	350 - 375	175 - 190	7 - 15
True Aero	2 & 4	325 - 350	160 - 175	7 - 15
Bake	2	325	160	70 - 80
Classic Bake	2	350	175	20 - 25
Bake	2	325 - 350	160 - 175	50 - 60
Bake	2	275 - 300	135 - 150	3 - 6 hours
Bake	2	350	175	30 - 40
Bake	2	350	175	15 - 25
Aero Bake	3	365	185	13 - 18
True Aero	2 & 4	345	170	13 - 18
Aero Bake	3	345	170	23 - 30
True Aero	2 & 4	345	170	23 - 30
Bake	3	425 - 450	215 - 230	10 - 12
Vent Bake	3	250 - 270	120 - 130	60 - 70
Bake > Vent Bake	2	350	175	40 - 50
Bake > Vent Bake	2	375	190	35 - 45
Bake	3	375	190	15 - 18
Rapid Proof	2	NA	NA	30
Aero Pastry	2	350	175	15
Aero Bake	3	390	200	15 - 25
Aero Bake	3	390	200	20 - 30
Aero Bake	3	390 - 400	200 - 210	30 - 35
True Aero	2 & 4	390 - 400	200 - 210	30 - 35
Aero Bake	3	375 - 390	190 - 200	15 - 25
True Aero	2 & 4	375 - 390	190 - 200	15 - 25
Aero Bake	3	400 - 350	200 - 175	20 - 25
Classic Bake	2 or 3	325	160	50 - 60
Classic Bake	2 or 3	350 - 375	175 - 190	15 - 30
Classic Bake	2 or 3	350 - 300	175 - 150	15 - 30
Classic Bake	2 or 3	275	135	35 - 45
Classic Bake	2 or 3	350	175	35 - 45

COOKING CHARTS

SAVOURY

FOOD	SHELVES
Cornbread	Single
Vegetables	Single
Lasagne	Single
Casserole	Single
Pizza	Single
Quiche (blind bake, then add filling)	Single
Potatoes (whole, baked)	Single
Frittata (shallow)	Single
Oven Meals	Single

ROASTING

FOOD	SHELVES *	RECOMMENDED FUNCTION		
Beef (Boneless)	Rare	Roast		
	Medium	Roast		
	Well Done	Roast		
Prime Rib Roast	Rare	Roast		
	Medium	Roast		
	Well Done	Roast		
Lamb Rack	Medium Rare	Bake		
Lamb leg (Bone in)	Medium	Roast		
	Well Done	Roast		
Lamb leg (Boneless)	Medium	Roast		
	Well Done	Roast		
Veal	Medium	Roast		
	Well Done	Roast		
Chicken	Whole Unstuffed	Aero Broil		
	Whole Stuffed	Bake		
	Whole Butterflied	Aero Broil		
Turkey (Whole)	Stuffed	Bake		
	Unstuffed	Bake		
Pork (Boneless)	Medium	Roast		
	Well Done	Roast		
Pork Crackling	Crisp (watch closely)	Aero Broil		
Venison	Brown in a pan first.	Rare	Single	Aero Broil
		Medium		Aero Broil

* If multiple shelves are required (eg roasting vegetables at the same time), use Aero Broil and shelf positions 1 & 4.

COOKING CHARTS

RECOMMENDED FUNCTION	SHELF POSITIONS	TEMP (°F)	TEMP (°C)	TIME (MINS)
Aero Bake	3	400 - 425	210 - 215	20 - 25
Vent Bake	3	350 - 375	175 - 190	30 - 50
Aero Bake	2 or 3	350 - 375	175 - 190	35 - 40
Bake	2	300 - 350	150 - 175	2+ hours
Aero Pastry	2	425	220	10 - 15
Aero Pastry	3	350	175	15 - 30
Bake	3	390	200	50 - 60
Aero Pastry	3	340 - 360	170 - 180	15 - 20
True Aero	3	340 - 375	170 - 190	30 - 40

SHELF POSITIONS	TEMP (°F)	TEMP (°C)	TIME (MINS)	MEAT PROBE (°F) **	MEAT PROBE (°C) **
2	320 - 340	160-170	18-32 /450g	130-138	54-59
2	320 - 340	160-170	25-40 /450g	140-165	60-74
2	320 - 340	160-170	30-55 /450g	165-174	74-79
2	320 - 340	160-170	15-30 /450g	130-138	54-59
2	320 - 340	160-170	20-35 /450g	140-165	60-74
2	320 - 340	160-170	25-40 /450g	165-174	74-79
2	390	200	20	122	50
2	320 - 340	160-170	18-28 /450g	149-158	65-70
2	320 - 340	160-170	20-33 /450g	165-174	74-79
2	320 - 340	160-170	20-35 /450g	149-158	65-70
2	320 - 340	160-170	25-45 /450g	170-174	77-79
2	320 - 340	160-170	20-40 /450g	160	71
2	320 - 340	160-170	25-45 /450g	170	76
2	350	175	15-20 /450g	165	75
2	350	175	17-22 /450g	165	75
3	350	175	40-50	165	75
1	320 - 340	160-170	17-22 /450g	165	75
1	300 - 330	150-165	15-20 /450g	165	75
2	340 - 350	170-175	25-40 /450g	145-154	63-68
2	340 - 350	170-175	30-45 /450g	165-174	74-79
3	430	220	5 to 10	na	na
3	435	225	7 /2.5cm meat thickness	120-129	49-54
3	435	225	9 /2.5cm meat thickness	131-140	55-60

** The internal temperature will rise more on standing.

COOKING CHARTS

BROILING

FOOD		SHELVES	
Beef	Steak	Rare	Single
		Medium	Single
	Hamburger (ground - patties)		Single
	Meatballs (ground)		Single
Lamb Chops		Medium	Single
		Well done	Single
Pork	Chops (well done)		Single
	Ham steak		Single
	Bacon		Single
Chicken	Boneless pieces		Single
	Bone In Pieces		Single
Sausages	Sausages		Single
Fish	Fillets		Single
	Whole		Single
Vegetables	Sliced		Single

COOKING CHARTS

RECOMMENDED FUNCTION	SHELF POSITIONS	TEMP (°F)	TEMP (°C)	TIME (MINS)
Maxi Broil	5 or 6	HI	HI	8-10
Maxi Broil	5 or 6	HI	HI	10-15
Maxi Broil	5	HI	HI	12-15
Maxi Broil	5	HI	HI	12-15
Maxi Broil	5 or 6	HI	HI	15-20
Maxi Broil	5 or 6	HI	HI	20-25
Maxi Broil	5 or 6	HI	HI	15-20
Maxi Broil	5 or 6	HI	HI	15-20
Maxi Broil	6	HI	HI	4-7
Aero Broil	4	350	175	30-50
Aero Broil	4	350	175	40-50
Maxi Broil	5	HI	HI	10-15
Aero Broil	5	390-430	200-220	8-12
Aero Broil	4 or 5	390-430	200-220	15-20
Maxi Broil	5	HI	HI	8-12

AUTOMATIC COOKING

- You can set the oven to automatically turn on later, cook for a preset time (cooking time), then automatically turn off at a preset stop time. See the example and instructions below (steps 1 to 7).
- If you start cooking manually and only want the oven to turn off automatically after a set cooking time: simply set the cooking time following steps 1 to 3 below and selecting a function and temperature. The oven will automatically turn off when the cooking time is over.
- Alternatively you can simply set the time of day you wish to the oven to turn off. Follow steps 4 and 5. The oven will automatically turn off when the stop time is reached.
- You may have the timer on at the same time as automatic cooking.
- Note: the broil element will come on while the oven is heating up. Uncovered foods may be browned on top.

IMPORTANT!

Safe food handling: leave food in the oven for as short a time as possible before and after cooking or defrosting. This is to avoid contamination by organisms which may cause food poisoning. Take particular care during warmer weather.

Example: It is 11:05 a.m. You want your food to cook for 1 hour, and you would like it to be ready by lunchtime (12:30 p.m.)

Set the cooking time

◀ ▶ ✓ ✕
REMOTE CANCEL

① Make sure that your oven is displaying the correct time of day and food is in the oven.

▶

② Touch the right scroll ▶ control twice. The cooking time ⌚ indicator will come on.

▶

③ Touch select ✓ to confirm. The display will flash.

▶

④ Touch the right scroll ▶ control to set the cooking time. Make sure you allow for preheat time in your calculation.

▶

⑤ Touch select ✓ to confirm. The function dial halo will flash.

Set the stop time

◀ ▶ ✓ ✕
REMOTE CANCEL

⑥ Touch the right scroll ▶ control to scroll to the stop time ⌚ indicator.

▶

⑦ Touch select ✓ to confirm. The display will flash.

▶

⑧ Touch the right scroll ▶ control to set the time you would like your food to be ready by (ie the stop time).

▶

⑨ Touch select ✓ to confirm.

Select function and temperature

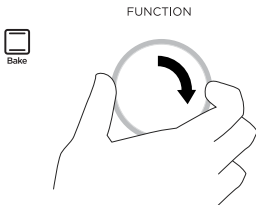

- ⑩ Select a function.
The function halo will stop flashing.

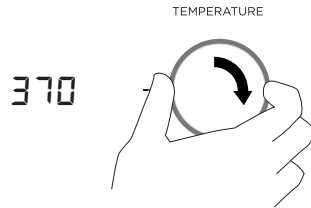

- ⑪ Adjust the temperature.

When automatic cooking is set

- The oven and the lights will stay off, the halos will be unlit, but your oven is now set for automatic cooking. It will automatically turn on at the required time.
- In a few seconds, the display will show the time of day with the cooking time ⌚ and stop time ⌚ indicators lit.
- You can modify the function and temperature while the oven is waiting to start cooking.
- If setting a delayed cook you will need to put the food in the oven before starting.
- For safety reasons opening the door while the oven is waiting to start will cancel delayed cook.

When the stop time is reached

The oven will automatically turn off and a long tone will sound.

To check the set cooking time and stop time

Use the scroll ◀ ▶ controls.

To change the cooking or stop time

Use the right scroll ▶ control to scroll to the cooking time ⌚ or the stop time ⌚, touch ✓ to select the one you want change and use the scroll ◀ ▶ controls to change the time. Touch ✓ to confirm.

To see the current time of day

Touch the cancel × control.

To cancel automatic cooking

Turn the function dial to Off .

USING THE MEAT PROBE (SOME MODELS ONLY)

Using the meat probe

Use your meat probe to accurately judge when your meat is perfectly cooked. You can use the probe with any function.



- ① Select the oven function and temperature. Preheat the oven if appropriate. Remember Roast and Aero Broil do not require preheating.

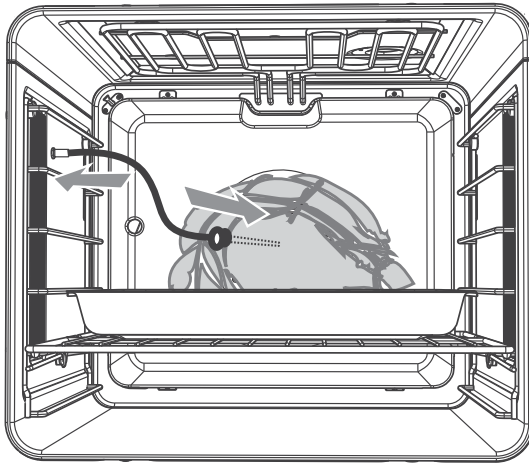

- ② Insert the metal probe horizontally into the center of the thickest part of the fully defrosted meat. The thicker the meat, the longer it will take to cook, so it is important that the probe is measuring the temperature of the meat at its thickest point. Make sure the probe does not touch bone, fat or gristle, as these will heat up more quickly than the lean meat.
- ③ Place the meat in the broil pan (or other suitable uncovered) dish.
- ④ When the oven has preheated (if required) to the set temperature, place the pan in the oven and insert the plug end of the meat probe into the probe socket, using an oven mitt if the oven is hot. The probe socket is on the left hand side of the oven, between shelf positions 4 and 5. Make sure the probe is pushed completely into the socket, then close the oven door.

USING THE MEAT PROBE (SOME MODELS ONLY)

150 

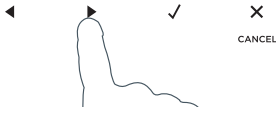

- ⑤(A) Press the right scroll ▶ button 4 times and the meat probe indicator will come on and the display will show 150.
- ⑤(B) Press the select ✓ button to confirm.
- The display will then flash 150.

165 

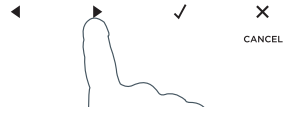

- ⑥ Use the scroll ◀ ▶ buttons to set the required meat temperature.

100 

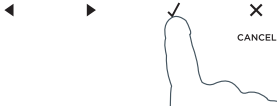

- ⑦ Press select to confirm.
- the meat probe indicator will remain on
 - the display will alternate between the set temperature and the internal temperature of the meat.

- ⑧(A) When the preset temperature is reached:
- a tone will sound every 15 seconds
 - the oven will turn off
 - the display will show the time of day.
- ⑧(B) Press any button to cancel the tone.

Tips for using the meat probe

- You can still use the timer when the meat probe is in use.
- You cannot use the meat probe with Automatic cooking or rotisserie.
- The internal temperature of the meat will continue to rise by a few degrees after you have removed it from the oven, so allow for this in your calculations. Cover with foil and let it rest for 15 to 20 minutes.
- If you wish to remove the meat from the oven (eg basting), unplug the meat probe from the socket but do not remove it from the meat. The display will show -- . When you are ready to resume cooking, re-insert the probe plug into the socket and the display will alternate between the preset and current internal temperature of the meat.

IMPORTANT!

- **Use only the meat probe supplied with your oven, purchased from your Fisher & Paykel dealer or replaced under warranty by your nearest Fisher & Paykel trained and supported service technician.**
- **Hold the meat probe at the handle when inserting and removing it from food and the meat probe socket.**
- **Remember to remove the meat probe from the oven before you start a self-clean cycle.**
- **Do not store the probe in the oven.**
- **Only use the probe with fully defrosted food.**
- **Wash the meat probe in mild soapy water but do not immerse. It is NOT dishwasher safe.**

USER PREFERENCE SETTINGS

You can set your oven to:

- display the temperature in degrees Celsius or Fahrenheit
- give audio feedback (tones and beeps) or operate quietly
- display time as 12-hr or 24-hr
- operate with the display off
- have its lights on or off during cooking
- operate in Sabbath setting (see 'Sabbath setting' following).

Note: You cannot change the user preference settings when your oven is operating or set for automatic cooking.

USER PREFERENCE SETTINGS

How to change preference settings

11:05

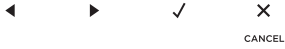

24:hr

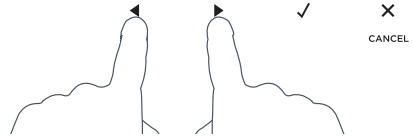

- ① Check the oven function dial is set to OFF and that the display shows the time of day.
 - If you're unsure, touch the cancel X control twice.

- ② Touch and hold the scroll ◀ ▶ controls together for 3 seconds to enter the user preference menu.

of

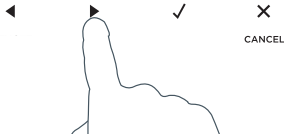

of

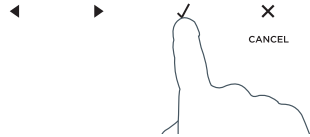

- ③ Touch the right scroll ▶ control to scroll to the setting you want to change. Refer to the following table.

- ④ Touch the select ✓ control to select the particular setting.
 - The display will flash.

USER PREFERENCE SETTINGS

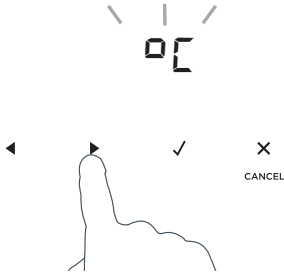

- ⑤ Touch the right scroll ► control to scroll through the options for that particular setting. Refer to the table below.

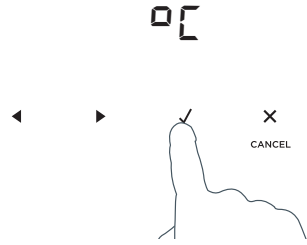

- ⑥ Touch the select ✓ control to save the new option .
- ⑦ For all options except 'Display off' : touch the cancel × control to quit the user preference menu.

USER PREFERENCE SETTINGS

SETTING	DEFAULT OPTION	ALTERNATIVE OPTION(S)	
TIME SCALE & 'DISPLAY OFF' OPTION Select between 24-hr or 12-hr clock display (and set the clock) or set 'Display off' option if you only need the basic functionalities of your oven.	24 HR 24Hr	12 HR 12Hr	DISPLAY OFF ** OFF
TEMPERATURE SCALE Select between degrees Celsius or Fahrenheit.	FAHRENHEIT OF	CELSIUS OC	
AUDIO FEEDBACK Turn the beeps and tones on or off.*	BEEPS/TONES ON bPon	BEEPS/TONES OFF bPof	
OVEN LIGHTS Have the light off during cooking if you want to save power or want the food you cook to be a surprise for others.	LIGHTS ON DURING COOKING LtOn	LIGHTS OFF DURING COOKING LtOf	
SABBATH SETTING	SABBATH OFF SbOf	See 'Sabbath setting' for instructions.	
WIRELESS CONNECTION (not available on this product)	OFF OFF		

* The timer tone and alert beeps will sound even if you save the BEEPS/TONES OFF option.

** With this option saved, you can still use the oven, and timer, however the display will remain unlit. Any automatic functions will be cancelled when this option is selected.

To quit this option and enable the display, touch and hold the cancel X control.

SABBATH SETTING

This setting is designed for religious faiths that observe a 'no work' requirement on the Sabbath.

While your oven is in Sabbath setting

- The display, dial halos and indicators will be unlit, the controls will be unresponsive.
- No tones or beeps will sound.
- No alert codes or temperature changes will be displayed.
- The oven lights will stay on. If you want the oven lights to be off during Sabbath setting, first select the 'Lights off' option as described in 'User preference settings', and only then set Sabbath setting.
- Bake  is the only function available in Sabbath setting.

How to set Sabbath setting

24:hr

Sb off

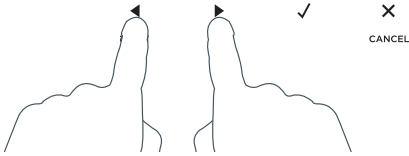

- ① Touch and hold the scroll ◀ ▶ controls together for 3 seconds to enter the user preference menu.

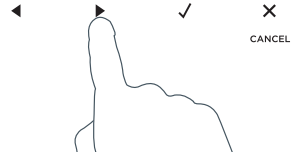

- ② Touch the right scroll ▶ control to scroll to the Sabbath setting.
- ③ Touch the select ✓ control to select the Sabbath setting. The default option is 'Sabbath off'.

1:00

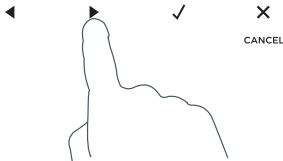

- ④ Touch the select ✓ control to activate the option.
- The display will flash 1:00.

SABBATH SETTING



- ⑤ Touch the scroll ◀ ▶ controls to set the time (hrs). You may set the time up to 48 hours.



- ⑥ Touch the select ✓ control to confirm the time.
- The function halo will flash.

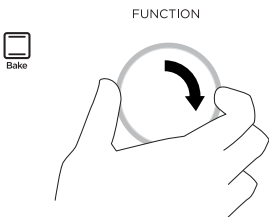

- ⑦ Select the Bake  function.
- ⑧ Adjust the desired temperature.

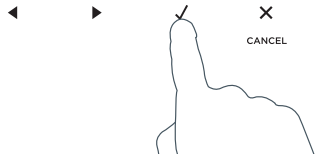

- ⑨ Touch the select ✓ control to activate Sabbath Setting.
- The display will go blank and all indicators will go out.
 - The oven will start up.

The display, indicators and dial halos will be unlit and unresponsive, but the oven will bake until you quit Sabbath setting.

To quit Sabbath setting

Touch and hold the cancel × control until the time of day appears in the display and the oven turns off.

CARE AND CLEANING

Manual cleaning

ALWAYS

- Before any manual cleaning or maintenance, first wait for the oven to cool down to a safe temperature to touch, then turn its power supply off at the wall.
 - Read these cleaning instructions and the 'Safety and warnings' section before you start cleaning your oven.
 - To prevent soiling from becoming 'baked on' and stubborn, we recommend removing any easy-to-reach spills, food or grease stains from the oven cavity enamel after each use.
 - Always clean the inner glass pane before starting a Self Clean cycle (where available). Failure to do this will mean that residue will bake on and be impossible to remove.
 - Always remove oven shelves before starting a Self Clean cycle (where available).
-

NEVER

- Never use a steam cleaner.
 - Never store flammable substances in the oven.
 - Never use abrasive or harsh cleaners, cloths, scouring pads or steel wool. Some nylon scourers may also scratch. Check the label first.
 - Never use oven cleaner on catalytic panels or in a pyrolytic oven.
 - Never leave alkaline (salty spills) or acidic substances (such as lemon juice or vinegar) on the oven surfaces.
 - Never use cleaning products with a chlorine or acidic base.
-

CARE AND CLEANING

Manual cleaning

WHAT?	HOW?	IMPORTANT!
Control Panel	Take particular care when cleaning the control panel glass. Only use a damp cloth with detergent.	Do not use any oven cleaners, harsh or abrasive cleaners, scouring pads, steel wool or sharp metal scrapers on the glass. These may scratch and damage the surface.
Dials	Clean with a solution of mild detergent and hot water, then wipe dry.	Do not use stainless steel or oven cleaner on the dials, as doing so may damage their coating.
Stainless steel strip/handle on the front of the oven door	<ul style="list-style-type: none">• Clean with a solution of mild detergent and hot water, then wipe dry with a microfibre cloth.• If necessary, use a suitable stainless steel cleaner and polish.	<ul style="list-style-type: none">• Always read the label to make sure that your stainless steel cleaner does not contain chlorine compounds as these are corrosive and may damage the appearance of your oven.• Always rub the stainless steel in the direction of the grain.
Oven door frame and plastic corner clips	Clean with a solution of mild detergent and hot water, then wipe dry.	

CARE AND CLEANING

Manual cleaning

WHAT?	HOW?	IMPORTANT!
Oven cavity (models without 'Selfclean' function only)	<ul style="list-style-type: none"> • Remove everything from the oven: all shelves and trays, the side racks (including fixing nuts). ① Wipe the inside of the oven using a household detergents or an ammonia-based cleaner. ② Wipe clean with a damp cloth and allow to dry completely. 	<ul style="list-style-type: none"> • To prevent soiling from becoming 'baked on' and stubborn, we recommend removing any easy-to-reach spills, food or grease stains from the enamelled surfaces after each use. • To make cleaning the oven ceiling easier, the broil element can be lowered. See following pages for instructions.
Oven cavity (models with 'Self Clean' function only)	<ul style="list-style-type: none"> • To clean light soiling off the enamelled surfaces: <ul style="list-style-type: none"> ① Wipe with a damp cloth and a solution of hot water and mild detergent or an ammonia-based cleaner. ② Wipe dry with a soft cloth. • To clean stubborn, 'baked on' soiling or the whole oven cavity: use the Self Clean function. See 'Using the Self Clean function' for instructions. 	<ul style="list-style-type: none"> • To prevent soiling from becoming 'baked on' and stubborn, we recommend removing any easy -to-reach spills, food or grease stains from the enamelled surfaces after each use. Doing so will reduce the need for using the Self Clean function frequently. • To make wiping out the oven easier you may remove the oven door. See the following pages for instructions.
Meat Probe	Clean with a solution of mild detergent and hot water, then wipe dry with a microfiber cloth.	<ul style="list-style-type: none"> • Clean after every use to avoid contamination. • Do not wash in the dishwasher, immerse in soapy water, use oven cleaner or leave in the oven during a Self Clean cycle.

CARE AND CLEANING

Manual cleaning

WHAT?	HOW?	IMPORTANT!
Full extension sliding shelf	Wipe with a damp cloth and mild detergent. Do not wipe off or wash away the white lubricating grease (visible when the shelf is extended).	Never leave in the oven during a Self Clean cycle. Do not wash the shelf in the dishwasher, immerse in soapy water, or use oven cleaner on it. Doing so will prevent the slides from running smoothly.
Grid Broil rack Broil Pan Wire oven shelves	<ul style="list-style-type: none"> • Clean with a solution of mild detergent and hot water. • Pre-soak stubborn burnt-on stains in a solution of dishwasher powder and hot water. • These parts are also dishwasher safe. 	Never leave any of these parts in the oven during a Self Clean cycle (except for the side racks). They will become discolored or damaged.
Oven seal (models without 'Self Clean' function only)	Clean with a solution of mild detergent and hot water.	
Oven seal (models with 'Self Clean' function only)	Do not clean this part.	
Oven door glass	Clean with a mild solution of detergent and warm water. Use a glass cleaner to remove smears.	Do not use any oven cleaners, harsh or abrasive cleaners, scouring pads, steel wool or sharp metal scrapers on the glass. These may scratch the surface and cause the glass to shatter. Only a Fisher & Paykel trained and supported service technician can take apart the door. Do not attempt to take the door apart for cleaning. If the inner panes of glass in the door become dirty, please contact a Fisher & Paykel trained and supported service technician or Customer Care.

CARE AND CLEANING

Removing the side racks

Remove the side racks to make cleaning the oven easier.

For models with Self Clean only:

The side racks can be left in the oven during the self clean cycle.

IMPORTANT!

Always turn off the oven at the wall first. Ensure the oven has cooled down completely before starting.

Remove all shelves

- 1 Slide out all shelves and remove.

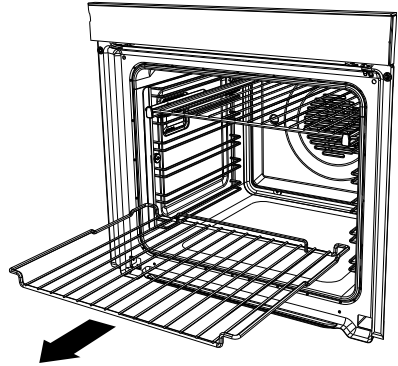

Remove all shelves

Remove both side racks

- 1 Unscrew and remove the fixing nut at the front of the side rack. Use a coin to loosen the nut if necessary.
- 2 Pull the front of the rack toward the back of the oven until the front tab is clear of the fixing nut.
- 3 Slide the side rack forward until the rear prongs are clear of the holes.

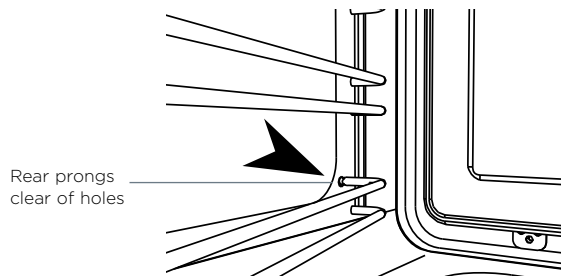
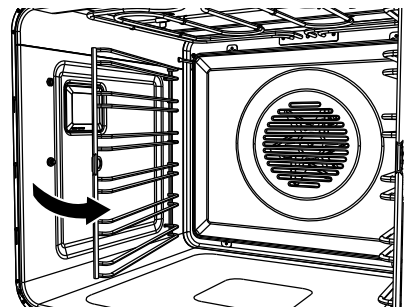
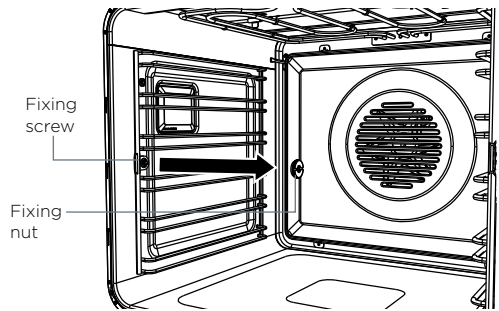

CARE AND CLEANING

Refitting the side racks

- ① Slide the rear prongs of the side rack back into the holes, ensuring the rack is firmly pushed up against the side wall of the oven.
- ② Fit the side rack front tab over the fixing screw.
- ③ Replace the fixing nut. You may use a coin to tighten the nut.

Insert rear prongs into holes

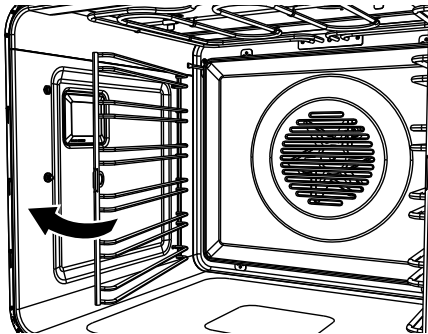
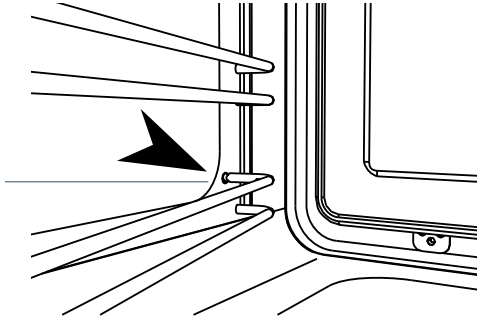

Fixing screw

Fixing nut

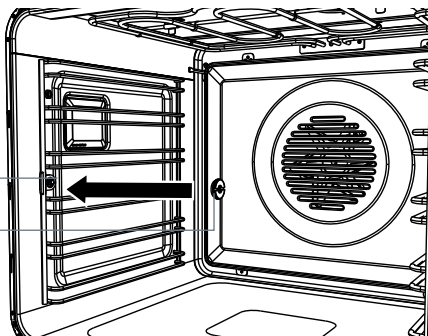

CARE AND CLEANING

Drop-down upper element (models without a Self clean function only)

IMPORTANT!

**Always turn off the oven at the wall before lowering the upper element.
Make sure the oven has cooled down completely before starting.**

- To lower the upper element: Pull both the securing clips forward to release the element. The element will now drop down to enable cleaning.
- When you have finished cleaning the oven ceiling, pull the securing clips forward, raise the element and release the clips. Make sure the element is securely held in place.
- The element itself is self-cleaning.

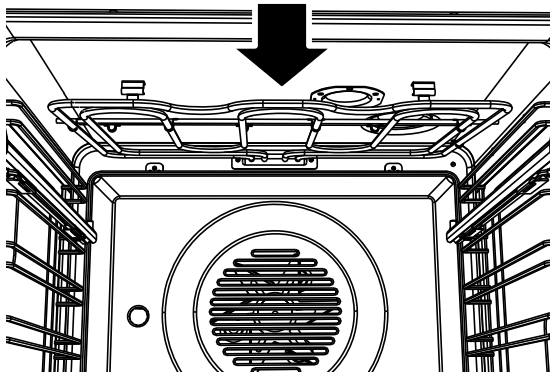
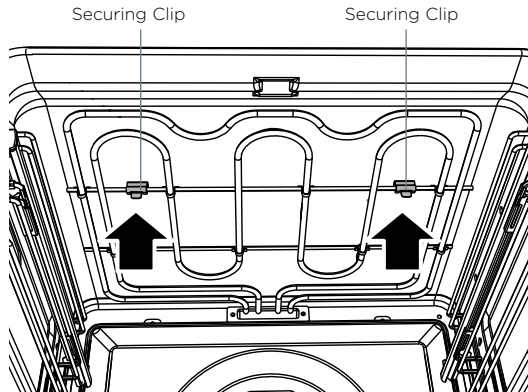

Drop down broil element

CARE AND CLEANING

Replacing the oven light bulbs

Note: Oven bulb replacement is not covered by your warranty.

Your oven uses G9 halogen bulbs with the specifications 120V, 50Hz and 25W.

Always hold the replacement bulb in a soft cloth. Touching the bulb will reduce its life-span.

The two oven lights are located behind the opaque glass panels on each side wall of your oven (one on each side).

Changing the bulb

- ① Let the oven cavity and broil element cool down before changing the bulb. Before switching off the oven, take note of which light(s) are not working.

IMPORTANT!

Turn the oven off at the wall before continuing.

- ② Remove the oven shelves and side racks (see 'Care and cleaning').
- ③ Pull the glass cover off (if you find this difficult, you can gently prise the cover off using the handle of a spoon or similar in the notches between the glass panel and oven wall while holding the cover to ensure it does not fall).
- ④ Pull out the faulty bulb.
- ⑤ Holding the replacement bulb in a soft cloth or tissue (touching the bulb with your fingers will reduce its life span) insert it into the socket.
- ⑥ Replace the glass cover pushing it firmly into place.

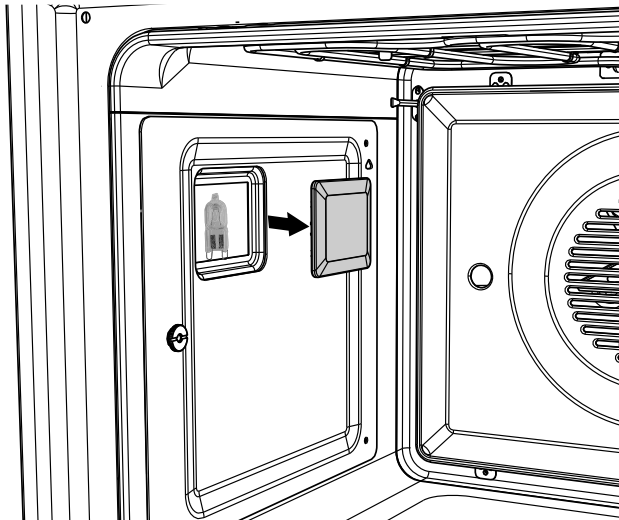

CARE AND CLEANING

Removing and refitting the oven door.

IMPORTANT!

Take care, the oven door is heavy.

To remove the door

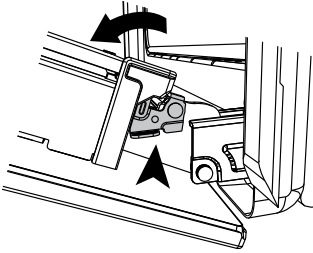

- ① Open the door fully. Locate the two small metal locking levers on both door hinges either side.

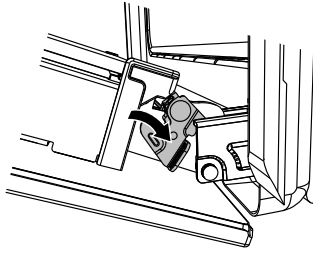

- ② Push each locking lever down fully to release the door from the hinge.

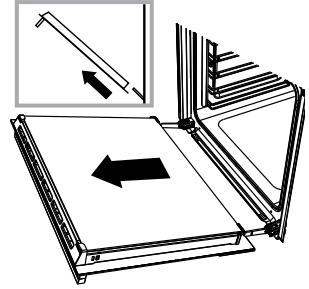

- ③ Holding the door on both sides, lift door back up to 45° and carefully pull the door out and away from the hinges.

To refit the door

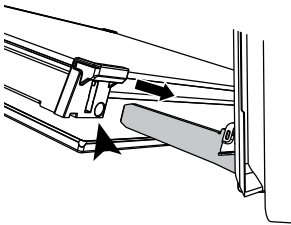

- ④ Holding the door on both sides, line up the holes in the base of the door with the hinges and slide the door on.

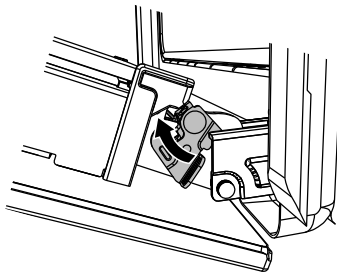

- ④ Once the door is fully located on the hinges, push each locking lever up fully to lock the door onto the hinge.

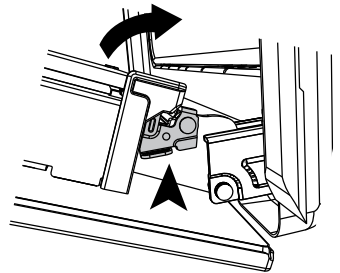

- ④ **IMPORTANT!** Ensure the levers are both fully locked before trying to shut the door.

USING THE SELF CLEAN FUNCTION (SOME MODELS ONLY)

- During the pyrolytic Self Clean cycle the extremely high temperature burns off and breaks down grime and grease deposits. All that is left is a small amount of grey ash that you can easily remove.
- There is a choice of two Self Clean cycles:
 - **Self Clean** (minimum 4 hours) (for normal soiling).
 - **Light Self Clean** (minimum 3 hours) (suitable for a light or localised soiling).

IMPORTANT!

- **You must clean the inside glass door panel BEFORE starting a self-clean cycle. Failure to do this may result in permanent staining or marking of the door glass. See 'Care and cleaning' for our recommendations on how to do this.**
- **Do not use oven cleaners, any degreasing cleaners, or oven liners.**
- **Remove all oven shelves, trays, bakeware and utensils from the oven before starting a self clean cycle (except side racks). If left in the oven they will be permanently damaged; items made from combustible material (eg wood, fabric, plastic) may even catch fire.**
- **Do not use your oven to clean miscellaneous parts.**
- **Make sure the room is well ventilated.**
- **Before starting a Self Clean cycle, make sure you move any pet birds to another, closed and well-ventilated room. Some pet birds are extremely sensitive to the fumes given off during a Self Clean cycle, and may die if left in the same room as the oven during such a cycle.**
- **During a Self Clean cycle, the oven reaches higher temperatures than it does for cooking. Under such conditions, the surfaces may get hotter than usual and children should be kept away.**
- **The oven door will be locked during the Self Clean cycle.**
- **If there are cracks or flaws on any of the oven door glass panes, if the oven seal is damaged or worn, or if the door does not close properly, do not start a Self Clean cycle. Call a Fisher & Paykel trained and supported service technician or Customer Care.**

To start a Self Clean

- ① Remove all oven shelves, accessories, bakeware, and utensils.
Note: you do not need to remove the side racks.
- ② Wipe up any spills, and along the inner edge of the oven surface around the seal. Failure to do so may discolor the oven surface.

IMPORTANT!

Avoid cleaning the seal itself as this may cause damage.

- ③ Check the inner glass pane of the oven door. If it has soiling on it (eg stains from greasy splatter), you will need to clean it manually before starting a Self Clean cycle. For instructions, see 'Care and cleaning'.



IMPORTANT!

- **If soiling is left on the glass, it will become burnt on during the Self Clean cycle, making it very difficult to remove.**
- ④ Close the oven door firmly.

USING THE SELF CLEAN FUNCTION (SOME MODELS ONLY)

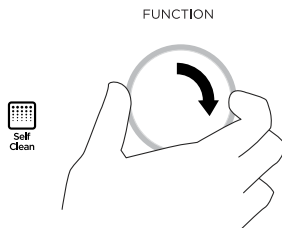

- ⑤ Select the Self Clean  function.
- The display will flash **0:00**

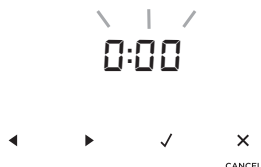

- ⑥ Touch the right scroll  control once for the **Self Clean** cycle
- the display will flash **4:00** (4 hours), or
 - Touch the right scroll  control a second time for the **Light Self Clean** cycle
 - the display will flash **3:00** (3 hours)



- The temperature indicator will be blank, as temperature cannot be adjusted.

- ⑦ Touch the select  control to start the Self Clean cycle.
- The time will start counting down.
 - For your safety, the oven door will automatically lock and remain locked during the cycle.
 - Note: if the select  control is not touched within 15 seconds, the oven will automatically turn off. Start from step 3 again. If the door is not shut properly or is reopened before the self clean cycle starts, the oven will automatically turn off.



During the Self Clean cycle

- The temperature and function halos and the oven lights will remain off.
- The Self Clean  function will be lit.
- The display will countdown the time remaining.

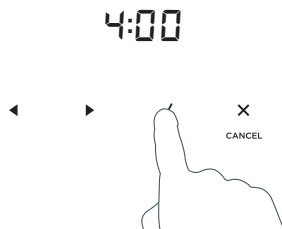

USING THE SELF CLEAN FUNCTION (SOME MODELS ONLY)

When a Self Clean cycle has finished

The oven will:

- emit a long tone
- automatically turn off
- automatically unlock the door (when the oven has cooled to a safe temperature).

In a few seconds, the display will show the time of day.

You need to:

- ① wait for the oven to cool down completely
- ② remove the grey ash with a small brush or damp cloth
- ③ wipe out the oven with a clean damp cloth
- ④ dry with a clean lint-free cloth
- ⑤ replace the oven shelves.



To cancel a Self Clean cycle

IMPORTANT!

- **A Self Clean cycle can be cancelled at any time by touching the cancel × control.**
 - **The door will not unlock until the oven has cooled to a safe temperature.**
- Do NOT turn off the mains power supply to the oven (wall switch). Turning off the power while the oven is too hot may damage the oven and its surrounding cabinetry.**



To cancel a Self Clean cycle, touch the cancel × control.

- If the oven needs to cool down, the Self Clean  function indicator will stay lit, the display will show the remaining cool-down time, the temperature indicator will show cascading bars  and the door will remain locked.
- When it has cooled down, the oven will turn off, the door will unlock, a long tone will sound and the display will show the time of day.
- We do not recommend cancelling a Self Clean cycle and then immediately starting one again.

TROUBLESHOOTING

Troubleshooting chart

If there is a problem, check the chart below to see if you can fix it. If the problem cannot be fixed or persists, call a Fisher & Paykel trained and supported service technician or Customer Care.

PROBLEM	POSSIBLE CAUSES	WHAT TO DO
General		
The oven does not work.	No power.	Check that the mains power supply (wall switch) is turned on, the fuse has not tripped and there is no power outage in your area.
	The clock has not been set	The oven will not work unless the clock is set. See 'Setting the clock'.
The oven does not work but the display is lit.	The oven is set for automatic cooking.	See 'Automatic cooking' for instructions.
The lights do not come on when I open the oven door.	The oven light bulb(s) have blown.	Replace the light bulb(s). See 'Care and cleaning' for instructions.
	The door is not correctly fitted.	See 'Care and cleaning' for instructions on fitting the door correctly.
	The oven is in Sabbath setting and the 'Light off' option has been saved.	To quit Sabbath setting, touch and hold the cancel × control. See 'User preference settings' for instructions on changing the 'Light off' option.
The temperature indicator is blank and the dials and controls are unresponsive.	The control panel is locked.	Touch and hold the select ✓ or cancel × control to unlock the control panel.
The oven is not heating.	The door is not properly closed or it is opened too frequently during cooking.	The heating elements are disabled while the door is open. Make sure the door is properly closed and avoid opening it frequently during cooking.
A glass pane in the oven door has cracked, chipped, or shattered.	Incorrect cleaning or the edge of the glass hitting against something.	You must NOT use the oven. Call your Fisher & Paykel trained and supported service technician or Customer Care.

TROUBLESHOOTING

PROBLEM	POSSIBLE CAUSES	WHAT TO DO
General		
I can feel hot air blowing out of the vents after I have turned the oven off.	This is normal.	For safety reasons the cooling fans will continue to run even when you have turned the function dial to 'Off'. The fans will switch off automatically when the oven has cooled.
The oven fan comes on when I select a function that does not use a fan (eg bake or classic bake)	This is normal. The fan comes on while the oven is preheating. It may turn off when the oven has reached the set temperature.	Wait until a long tone sounds and the temperature dial halo turns white: the oven will then be ready to use.
The oven has reached the set temperature but the temperature dial halo is still red (indicating that the oven is not ready to use).	This is normal: when heating up from cold, your oven is designed to initially heat to a temperature somewhat higher than what you have set. This is to provide optimal baking conditions right from the start.	Wait until a long tone sounds and the temperature dial halo turns white: the oven will then be ready to use.
The oven is heating but the display is dark.	The oven is set to 'Display off' option. The oven is in Sabbath setting.	To quit the 'Display off' option, touch and hold the cancel × control until the display shows the time of day. To quit Sabbath setting, touch and hold the cancel × control until the display shows the time of day.
The oven cancels automatic cooking when I try to adjust the clock setting.	The oven was set for automatic cooking when you were trying to adjust the clock setting.	You can only adjust the clock setting while the oven is not set for automatic cooking.
The oven sounds a tone when I try to turn the temperature dial OFF or below a certain temperature.	This is normal: for food safety reasons, the oven functions have factory-set minimum temperature settings.	The temperature dial itself cannot be 'turned off'. Selecting Off  with the function dial will turn the oven off.
The temperature dial halo never turns white when I use Broil  .	This is normal: the halo stays red to indicate that the broil element provides instant radiant heat.	
The displays work, and the function and temperature dials halos come on but the oven does not heat up.	The oven is in 'Demo' mode.	Call Customer Care.

TROUBLESHOOTING

PROBLEM	POSSIBLE CAUSES	WHAT TO DO
Self Clean function (some models only)		
During a Self Clean cycle, the oven is louder than usual.	This is normal: the oven's cooling fans operate at their highest speed.	
The display shows 0:00 but the oven door will not open.	The oven door is locked because the oven is still too hot to be used for cooking.	Wait until the Self Clean cycle has finished. If you cancelled a Self Clean cycle which was already underway, the oven still needs to cool down before it can be used. The oven door will automatically unlock.
At a point during a Self Clean cycle, the function dial halo goes out and the temperature indicator starts displaying cascading bars - - - -	This is normal: the oven is in the last phase of the Self Clean cycle, cooling down.	Wait until the Self Clean cycle has finished. A long tone will sound and the oven door will automatically unlock when the oven is ready to use.
I have cancelled a Self Clean cycle but cannot use the oven: <ul style="list-style-type: none"> the oven door will not open the display is still counting down minutes or showing 0:00 the Self Clean  function indicator is still lit the temperature indicator shows cascading bars - - - - the dials and controls are unresponsive. 	This is normal: if the function dial halo is unlit, you have successfully cancelled the Self Clean cycle. However, the oven is still too hot to be used for cooking and needs to cool down.	Wait until the cool-down phase has finished. A long tone will sound and the oven door will automatically unlock when the oven is ready to use. Note: depending on when the Self Clean cycle was cancelled, the cool-down phase may take up to 45 minutes.
The oven is beeping and the display shows A2 or A3.	See section 'Alert codes' for instructions.	
There is a power cut during a Self Clean cycle.	Power cut.	The door will remain locked. Once the power is turned back on, the door will remain locked until the oven has cooled to a safe temperature.

ALERT CODES

If there is a problem, the oven will:

- automatically suspend all oven functions
- beep five times
- display an alert code.

IMPORTANT!

Do not turn off the mains power supply to the oven (wall switch) if you get an alert code, unless the instructions in the chart following specifically instruct you to. There are cooling fans within the oven which are needed to cool the oven's components. Turning off the power while the oven is too hot may damage the oven and its surrounding cabinetry.

What to do if an alert code is displayed

- ① If the beeping hasn't stopped already, touch any control to stop it.
- ② Make a note of the alert code displayed. You may need this information.
- ③ Check the chart following to see if you can fix the problem yourself and follow the instructions.
- ④ If you can fix the problem and the alert code does not reappear, you can keep using your oven.

OR

If you can't fix the problem yourself or the alert code reappears and the problem persists: wait until the cooling fans have stopped and the oven has completely cooled down, then turn the power to the oven off at the wall and call a Fisher & Paykel trained and supported service technician or Customer Care with the alert code information.

ALERT CODES

ALERT CODE	POSSIBLE CAUSES	WHAT TO DO
A1	The oven has overheated.	<ol style="list-style-type: none">① Allow the oven to cool down.② Once the oven has cooled down and the door has unlocked, the alert code will disappear. You can now use the oven again.
A2	Door lock error: the door cannot be locked after you have started a Self Clean cycle.	<ol style="list-style-type: none">① Turn the power to the oven off at the wall and on again.② Wait approximately 10 seconds. This is to allow the door lock to return to its initial position.③ Set the clock. See 'Setting the clock and first use' for instructions.④ Try starting a Self Clean cycle again, making sure that you close the door firmly. See 'Using the Self Clean function'.
A3	Door lock error: the door cannot be unlocked after a Self Clean cycle has finished.	<ol style="list-style-type: none">① Turn the power to the oven off at the wall and on again.② Try touching on the oven door to help the door lock disengage.③ If this doesn't help and the alert code reappears, contact a Fisher & Paykel trained and supported service technician or Customer Care.
F + number	Technical fault.	<ol style="list-style-type: none">① Note down the alert code.② Wait until the cooling fans have stopped and the oven has completely cooled down.③ Turn the power to the oven off at the wall.④ Call your Fisher & Paykel trained and supported service technician or Customer Care with the alert code information.

WARRANTY AND SERVICE

Before you call for service or assistance ...

Check the things you can do yourself. Refer to the installation instructions and your user guide and check that:

- ① Your product is correctly installed.
- ② You are familiar with its normal operation.

If after checking these points you still need assistance or parts, please refer to the Service & Warranty book for warranty details and your nearest Service Center, Customer Care, or contact us through our website www.fisherpaykel.com.

Complete and keep for safe reference:

Model _____
Serial No. _____
Purchase Date _____
Purchaser _____
Dealer _____
Suburb _____
Town _____
Country _____

FISHERPAYKEL.COM

© Fisher & Paykel Appliances 2019. All rights reserved.

The product specifications in this booklet apply to the specific products and models described at the date of issue. Under our policy of continuous product improvement, these specifications may change at any time. You should therefore check with your Dealer to ensure this booklet correctly describes the product currently available.

US CA

591904A 03.19