

569L Series 7 French Door Refrigerator Freezer

Series 7 | Contemporary

Stainless Steel | French hinge



Our largest capacity French Door model has intuitive, flexible storage space, with a stylish stainless steel finish.

- ActiveSmart™ technology helps keep food fresher for longer by constantly maintaining the ideal temperature.
- Spacious bottom freezer with full extension drawer gives easy access to frozen goods.

DIMENSIONS

Height	1790 mm
Width	900 mm
Depth	695 mm

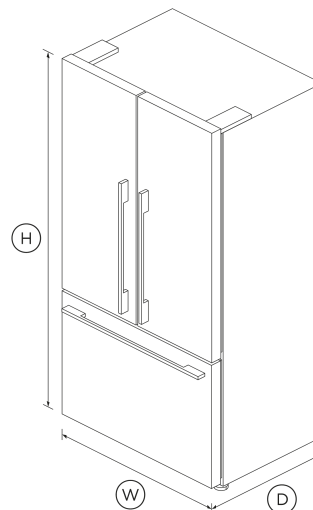

FEATURES & BENEFITS

ACTIVESMART™ FOODCARE

ActiveSmart™ Foodcare learns how you live. It's the technology that understands how you use your fridge and adjusts the temperature, airflow and humidity inside to help keep food fresher for longer.

Humidity Control

Your fruit and veges need different environments. The humidity control slides in each storage bin create a microclimate that helps keep food fresher for longer.

Easy Cleaning

Spill-safe secure glass shelves easily capture any drips or leaks and prevent them from falling on items below.

Clever Energy

Your fridge adapts to daily use by cooling and defrosting only when needed. This means your fridge uses the energy it needs without compromising on food care.

SIMPLE STORAGE

This fridge is designed to make it simple for you to store, access and remove food. Storage bins give you full access inside when they're pulled open and can be easily removed to clean. Our flexible shelving also gives you more storage options.

SPECIFICATIONS

Capacity

Total gross capacity	614 L
Volume	569 L
Volume freezer	152 L
Volume refrigerator	417 L

Consumption

Energy rating	3.5 star
Energy usage	448kWh/year
In-use energy carbon emissions estimate	291.8kgCO2e/year

Features

Adjustable glass shelves	2
Adjustable half width door shelves	4
Covered door shelves	2

Deli storage bins	2	Depth	695 mm
Door alarm	•	Depth (including handles)	735 mm
Front levelling feet	•	Height	1790 mm
Fruit and vegetable bins	2	Height to top of cabinet	1790 mm
Full extension runners	•	Minimum air clearance - each side	20 mm
Full width door shelves	2	Minimum air clearance - on top	50 mm
LED lighting	•	Width	900 mm
Rear rollers	•		
Single bottle holders	4		
SmartTouch control panel	•		

Freezer Features

Bottle chill	•
Fast freeze	•
Freezer bins	3
Ice trays	1

Performance

ActiveSmart™ Foodcare	•
Adaptive defrost	•
Frost free	•
Frost free freezer	•
Humidity control system	•
Inverter controlled compressor	•
R600a refrigerant	•
Sabbath mode	•

Product dimensions

Warranty

Parts and labour	2 years
Sealed system parts only	5 years

SKU	26504
-----	-------

The product dimensions and specifications in this page apply to the specific product and model. Under our policy of continuous improvement, these dimensions and specifications may change at any time. You should therefore check with Fisher & Paykel's Customer Care Centre to ensure this page correctly describes the model currently available. © Fisher & Paykel Appliances Ltd 2020

Other product downloads available at fisherpaykel.com

- [↓](#) Energy Label Freestanding French Door Refrigerator Freezer
- [↓](#) Service & Warranty
- [↓](#) Installation Guide
- [↓](#) Installation Guide - Surround Kit
- [↓](#) User Guide
- [↓](#) User & Installation Guide ActiveSmart Refrigerator

Where applicable:

All appliances use energy, and energy usage typically generates carbon emissions. **Fisher & Paykel Appliances' In-use Energy Carbon Emissions Estimate** indicates carbon emissions from a product's in-use energy. This is calculated either annually or per cycle, using the product's market-specific energy label energy consumption data multiplied by the carbon emissions factor for energy in your country or region.

Our In-use Energy Carbon Emissions Estimate is designed to assist customers in making informed purchasing decisions when comparing different Fisher & Paykel products. For example, a heat pump dryer typically has a lower In-use Energy Carbon Emissions Estimate than a vented dryer.



A PEACE OF MIND SALE
24 Hours 7 Days a Week Customer Support
 T 1300 650 590 W www.fisherpaykel.com