

Single DishDrawer Dishwasher, Sanitise

Series 7 | Contemporary

Stainless Steel



Designed to fit your full-sized dinner plates, this DishDrawer™ can be placed anywhere in your kitchen, for loading dishes with less bending.

- Six wash programs, as well as additional Quick wash, Sanitise and Extra Dry options
- Flexible racking allows you to customise internal shelves to suit your needs

DIMENSIONS

Height	410 mm
Width	599 mm
Depth	573 mm

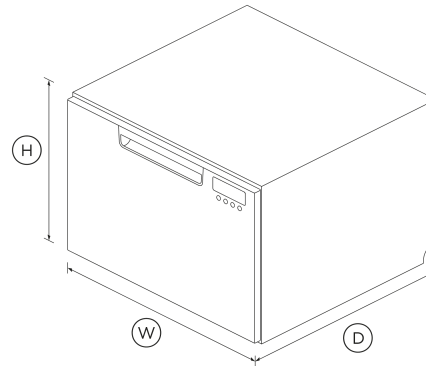

FEATURES & BENEFITS

Easy To Use

DishDrawer™ Dishwashers are as easy to open and close as kitchen drawers and can be conveniently positioned at bench height for ease of loading and minimal bending. Flexible racking allows you to make adjustments to fit in a variety of dishes.

Quick, Sanitise and Extra Dry options

The Quick wash modifier delivers a faster wash while maintaining performance. The Sanitise option provides extra protection, killing 99.9% of bacteria in the final rinse. The Extra Dry setting is perfect for plastic dishes.

Quiet Performer

Running at a very low decibel rating, these DishDrawer™ Dishwashers do their job without making a fuss. The combination of intelligent technology and simple mechanics means greater reliability and excellent wash performance.

Seamless Integration

DishDrawer™ Dishwashers integrate beautifully into any kitchen space. They're designed to match the Fisher & Paykel family of kitchen appliances, with matching handles, premium styling and quality materials.

SPECIFICATIONS

Accessories (included)

- Cutlery basket
- Knife clip and multipurpose clip

Capacity and loading

Accommodates round plates up to	280mm
Adjustable height, foldable cupracks	•
Fold down tines	•
Pitch adjustable tines	•
Place settings	7
Place settings	7

Consumption

Energy rating	3.5 star
Energy usage	136kWh/year
In-use energy carbon emissions estimate	88.6kgCO2e/year
Water rating	4.5 star (WELS)

Water usage (per wash cycle) **6.9L**

Controls

- Electronic fault/Diagnostic indicator •
- End of cycle beeps •
- Energy saving delay start option of up to 12 hours •
- Keylock •
- Rinse aid indicator light •
- Smart appliance •
- Wi-Fi connectivity •

Features

- Fan assisted drying •
- Flow through detergent dispenser •
- Motor type **BLDC**
- Quiet operation •
- SmartDrive™ technology •

Performance

Noise emissions **42 dBA**

Power requirements

Amperage **5A**
 Supply frequency **50Hz**
 Supply voltage **220 - 240V**

Product dimensions

Depth **573 mm**
 Height **410 mm**
 Width **599 mm**

Warranty

Parts and labour **2 years**

Wash Program Modifiers

Extra Dry •
 Quick •
 Sanitise •
 Wash modifiers **3**

Wash Programs

Delicate •
 Fast •
 Heavy •
 Medium •
 Normal eco •
 Rinse •
 Wash programs **6**

Water connection

Water pressure **30kPa - 1000 kPa**
 Water supply **3/4" BSP (20mm) Connector Water Inlet Hose**

SKU

82316

The product dimensions and specifications in this page apply to the specific product and model. Under our policy of continuous improvement, these dimensions and specifications may change at any time. You should therefore check with Fisher & Paykel's Customer Care Centre to ensure this page correctly describes the model currently available. © Fisher & Paykel Appliances Ltd 2020

Other product downloads available at fisherpaykel.com

- [↓](#) 2D-DWG Single DishDrawer™ Dishwasher
- [↓](#) 2D-DXF Single DishDrawer™ Dishwasher
- [↓](#) Data Sheet Single DishDrawer™ Dishwasher
- [↓](#) Energy and Water Label
- [↓](#) Service & Warranty
- [↓](#) Installation Guide Single DishDrawer™ Dishwasher
- [↓](#) Installation Guide Single DishDrawer™ Dishwasher
- [↓](#) Revit Single DishDrawer™ Dishwasher
- [↓](#) Rhino Single DishDrawer™ Dishwasher
- [↓](#) Sketchup Single DishDrawer™ Dishwasher
- [↓](#) Specification Guide Single DishDrawer™ Dishwasher
- [↓](#) User Guide DishDrawer™ Dishwasher
- [↓](#) Wash Program Data ASNZS DishDrawer™ Dishwasher

Where applicable:

All appliances use energy, and energy usage typically generates carbon emissions. **Fisher & Paykel Appliances' In-use Energy Carbon Emissions Estimate** indicates carbon emissions from a product's in-use energy. This is calculated either annually or per cycle, using the product's market-specific energy label energy consumption data multiplied by the carbon emissions factor for energy in your country or region.

Our In-use Energy Carbon Emissions Estimate is designed to assist customers in making informed purchasing decisions when comparing different Fisher & Paykel products. For example, a heat pump dryer typically has a lower In-use Energy Carbon Emissions Estimate than a vented dryer.



A PEACE OF MIND SALE
24 Hours 7 Days a Week Customer Support
T 1300 650 590 W www.fisherpaykel.com