

FISHER & PAYKEL

DISHDRAWER™ DISHWASHER

INTEGRATED

DD60DTX6I1, DD60STX6I1

USER GUIDE

SG

CONTENTS

Safety and warnings	5
First use	8
Loading suggestions	10
Wash programs	11
Wash modifiers	13
Delayed start	15
Keylock	16
Detergent	17
Rinse aid	20
Preferences	22
Wi-Fi connection & remote mode	24
Racking features	26
Maintenance	31
Maintenance alerts	35
Troubleshooting	36
Fault codes	39
Warranty and service	42

Registration

To register your product visit our website: fisherpaykel.com/register

SAFETY AND WARNINGS

READ AND SAVE THIS GUIDE

When using your DishDrawer™ Dishwasher, follow basic precautions, including the following:

General

- The information in this guide must be followed to minimise the risk of fire or explosion or to prevent property damage, personal injury or loss of life.
- Use the DishDrawer™ Dishwasher only for its intended function as described in this guide.
- This appliance is intended to be used in household and similar applications such as:
 - staff kitchen areas in shops, offices and other working environments
 - farm houses
 - by clients in hotels, motels and other residential environments
 - bed and breakfast environments.
- NSF 184-Certified residential dishwashers are not intended for licensed food establishments.
- Use only detergents or rinse aid recommended for use in a domestic dishwasher and keep them out of reach of children. Check that the detergent dispenser is empty after the completion of each wash program.
- When loading items to be washed, locate sharp items so that they are not likely to damage the internal lid of the DishDrawer™ Dishwasher and load sharp knives with the handle up to reduce the risk of cut injuries.
- Do not touch the filter plate in the DishDrawer™ Dishwasher base during or immediately after use, as it may be hot.
- Do not operate your DishDrawer™ Dishwasher unless all enclosure panels are properly in place.
- Do not tamper with the controls.
- Do not abuse, sit on, stand in or on the drawer or dish rack of the DishDrawer™ Dishwasher.
- The drawer should not be left in the open position since this could present a tripping hazard.
- The foldaway cup racks are designed to support cups, glasses and kitchen utensils. When the foldaway cup racks are in the drawer do not lean on or use them to support your body weight.
- To reduce the risk of injury, do not allow children to play in or on the DishDrawer™ Dishwasher.
- Under certain conditions, hydrogen gas may be produced in a hot water heater system that has not been used for two weeks or more. HYDROGEN GAS IS EXPLOSIVE. If the hot water system has not been used for such a period, before using the DishDrawer™ Dishwasher, turn on all hot water taps and let the water flow from each for several minutes. This will release any accumulated hydrogen gas. As the gas is flammable, do not smoke or use an open flame during this time.
- Remove the door to the washing compartment when removing an old DishDrawer™ Dishwasher from service or discarding it.
- Some dishwasher detergents are strongly alkaline. They can be extremely dangerous if swallowed. Avoid contact with the skin and eyes and keep children away from the DishDrawer™ Dishwasher when the door is open.
- Under no circumstances should you open the drawer whilst the DishDrawer™ Dishwasher is in operation.

SAFETY AND WARNINGS

- Always knock on the front of the drawer to pause and wait until you hear four beeps before opening the drawer.
- The DishDrawer™ Dishwasher must be used with the motor assembly, filter plate, filter, wire rack and spray arm in place. To identify what these parts are refer to 'Maintenance'.
- Take care not to load dishwasher items so they prevent the internal lid from properly sealing with the drawer. Items should be placed so they do not protrude above the drawer.
- If the DishDrawer™ Dishwasher is not being used for long periods of time, turn the electricity and water supply off.
- Cleaning and maintenance shall not be done by children without supervision.
- Do not allow children to play inside, on or with this appliance or any discarded appliance.
- Household appliances are not intended to be used by children. Children of less than 8 years old must be kept away from the appliance unless continuously supervised. This appliance can be used by children aged from 8 years and above, and persons with reduced physical, sensory or mental capabilities or lack of experience and knowledge, if they have been given supervision or instruction concerning the use of the appliance in a safe way and they understand the hazards involved.
- If a dishwasher cleaner is used, we recommend running a wash program with detergent immediately afterward to prevent any damage.
- The DishDrawer™ Dishwasher is designed for washing normal household utensils. Items that are contaminated by petrol, paint, steel, iron debris, corrosive, acidic or alkaline chemicals are not to be washed in the DishDrawer™ Dishwasher.
- Do not wash plastic items unless they are marked dishwasher safe or equivalent. For plastic items not marked, check the manufacturer's recommendations.
- Avoid washing containers with glued on labels. Labels removed during a wash cycle may cause damage to the wash system.

Installation

- This DishDrawer™ Dishwasher must be installed and located in accordance with the Installation instructions before it is used. If you did not receive Installation instructions with your DishDrawer™ Dishwasher, you can order them by calling your Authorised Repairer or download them from our local Fisher & Paykel website, listed on the back cover.
- Installation and service must be performed by a Fisher & Paykel trained and supported service technician.
- If the power supply cord is damaged, it must be replaced by a Fisher & Paykel trained and supported service technician or a qualified trades person in order to avoid a hazard.
- Ensure the DishDrawer™ Dishwasher is secured to adjacent cabinetry using the brackets provided. Failure to do so may result in an unstable product, which may cause damage or injury.
- Do not operate this appliance if it is damaged, malfunctioning, partially disassembled or has missing or broken parts, including a damaged power supply cord or plug.
- Do not store or use petrol, or other flammable vapours and liquids in the vicinity of the DishDrawer™ Dishwasher.
- Connect to a properly rated, protected and sized power supply circuit to avoid electrical overload.
- Ensure the power supply cord is located so that it will not be stepped on, tripped over or otherwise subject to damage or stress.

SAFETY AND WARNINGS

- Do not install or store the DishDrawer™ Dishwasher where it will be exposed to temperatures below freezing or exposed to weather.
- Do not use an extension cord or a portable electrical outlet device (e.g. multi-socket outlet box) to connect the DishDrawer™ Dishwasher to the power supply.
- This appliance must be grounded. In the event of a malfunction or breakdown, grounding will reduce the risk of electric shock by providing a path of least resistance for electric current.
- This appliance is equipped with a cord having an equipment-grounding conductor and a grounding plug. The plug must be plugged into an appropriate outlet that is installed and grounded in accordance with all local codes and ordinances. Improper connection of the equipment-grounding conductor can result in a risk of electric shock. Check with a qualified electrician or Fisher & Paykel trained and supported service technician if you are in doubt as to whether the appliance is properly grounded.
- Do not modify the plug provided with the appliance; if it will not fit the outlet, contact a Fisher & Paykel trained and supported service technician or qualified electrician.
- If the DishDrawer™ Dishwasher is installed as a permanently connected appliance, this appliance must be connected to a grounded metal, permanent wiring system, or an equipment-grounding conductor must be run with the circuit conductors and connected to the equipment-grounding terminal or lead on the appliance.

Maintenance

- Disconnect the appliance from the power supply before any cleaning or maintenance.
- When disconnecting the appliance pull the plug rather than the power supply cord or junction of cord to avoid damage.
- Do not repair or replace any part of the appliance or attempt any servicing unless specifically recommended in this guide. We recommend contacting a Fisher & Paykel trained and supported service technician or Customer Care.
- Keep the floor around your appliance clean and dry to reduce the possibility of slipping.
- Keep the area around/underneath your appliance free from the accumulation of combustible materials, such as lint, paper, rags and chemicals.

Wi-Fi

- Do not change or modify the wireless communication device in any way. Changes or modifications not expressly approved by Fisher & Paykel could void the user's authority to operate the equipment.

FIRST USE

- Ensure the installer has completed the 'Final checklist' in the Installation instructions.
- Read this guide, taking special note of the 'Safety and warnings' section.
- Remove all internal and external packaging and dispose of it responsibly. Recycle items that you can.

DD60DTX6I1 models

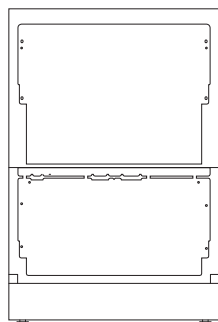

DD60STX6I1 models

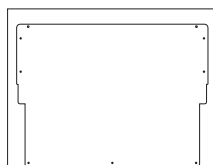

Control panel overview



Control panel features

- | | |
|----------------------------|-------------------------------|
| ① Wash program selector | ⑦ Lock indicator |
| ② Wash modifier selector | ⑧ Wi-Fi indicator |
| ③ Start | ⑨ Spray arm blocked indicator |
| ④ Wash program indicators | ⑩ Filter cleaning indicator |
| ⑤ Wash modifier indicators | |
| ⑥ Delay start indicator | |

FIRST USE

Dishware

The combination of high temperatures and dishwasher detergent may cause damage to some items. Refer to the manufacturer's guidance or wash by hand if in doubt.

Cutlery & silverware

All cutlery and silverware should be rinsed immediately after use to prevent tarnishing, **RINSE** is recommended. Silver should not come into contact with stainless steel, mixing these can cause staining. Remove silver cutlery from the DishDrawer™ Dishwasher and hand dry immediately.

Aluminium

Aluminium can be dulled by detergent. The degree of change depends on the quality of the detergent or aluminium.

Other metals

Iron and cast iron can rust and stain other items. Copper, pewter and brass tend to stain.

Woodware

Woodware is generally sensitive to heat and water. Regular use in the DishDrawer™ Dishwasher may cause deterioration over time.

Glassware

Most glassware is dishwasher safe. Crystal, very fine and antique glassware may etch and will develop a cloudy appearance.

Plastics

Some plastics may change shape or colour with hot water. Refer to the manufacturer's guide. Dishwasher safe plastic should be weighed down so it does not flip and fill with water or fall through the base rack during the wash.

Decorated items

Most modern china patterns are dishwasher safe. Antique items, those with a pattern painted over the glaze, gold rims or hand painted china may be more sensitive to machine washing.

Glued items

Certain adhesives are softened or dissolved in machine washing.

Water hardness

Hard water is water with a high concentration of minerals such as calcium and magnesium. It can be detrimental to the performance of your DishDrawer™ Dishwasher and parts can fail over time. Over time, glassware washed in hard water will become cloudy and dishes will become spotted or covered in a white film. Water hardness varies by geographical location. If you live in a hard water area, we recommend fitting a water softener to the household water supply.

If your home has hard water

- Refer to 'Powdered detergent quantity recommendations' and 'Water Softener'.
- Use rinse aid. We recommend you raise the rinse aid setting to 5 to help improve wash performance. Refer to 'Preferences' for details.

Use a dishwasher cleaner/descaler regularly, or whenever you notice a build-up of limescale deposits in your DishDrawer™ Dishwasher.

If your home has soft or softened water

- Avoid using too much detergent. Refer to 'Powdered detergent quantity recommendations.'

LOADING SUGGESTIONS

When loading your drawer ensure items are placed so water coming from the rotating spray arm below can reach all areas. Wash performance will be reduced if it can't.

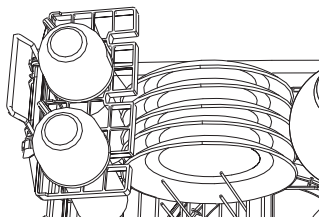

Ensure

- Spray arms can rotate freely.
- Glass and other fragile items are stable.
- All dish openings are facing downwards.
- Plates are evenly spaced.
- All sharp objects are located securely to avoid injury or damage to the product.

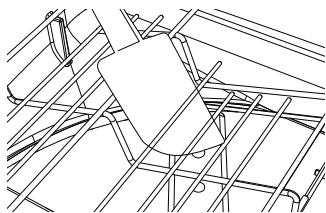

Avoid

- Overcrowding.
- Any protrusions below the racks and basket that may prevent spray arm rotation.
- Any protrusions at the top of the drawer.*
- Blocking water from any items on the foldaway cup racks.

Maximum place settings per drawer: 7

Wash program data & standards test information

Wash program data and standards test information can be viewed online by going to <https://www.fisherpaykel.com> and searching your model code.

*Maximum dishware height for standard tub models is 280mm and 310mm for tall tub models.

WASH PROGRAMS

Your DishDrawer™ Dishwasher has a number of wash programs designed to suit your needs. Selecting the most appropriate cycle for each load will help ensure the best wash results.

WASH PROGRAM	PROGRAM DESCRIPTION
AUTO	Suitable for any type of load. The dishwasher automatically selects the optimum wash program
HEAVY	Designed for heavily soiled pots, pans and dishes
MEDIUM	Best for dishes that are quite heavily soiled or to remove food soils that have been left to dry overnight
LIGHT	For very lightly soiled dishes with easy to remove soils; no drying
60MIN	Use for dishes that are quite heavily soiled or food soils that have been left to dry overnight; no drying
GLASSWARE	For lightly soiled and heat sensitive crockery and glassware such as wine glasses
ECO (default)	For normally soiled dishes for optimum water and energy use.
RINSE	Prevents odours and soils from drying on dishes

Setting a wash program

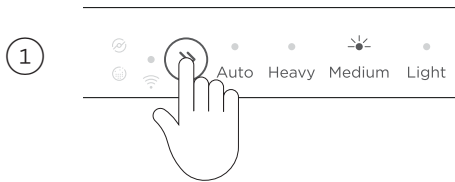

Ensure DishDrawer™ Dishwasher is turned on and detergent has been added.

Press » to scroll through the available wash programs, the selected wash program indicator will illuminate on the display.



Press ▶ to start the wash and close the drawer within 7 seconds.

WASH PROGRAMS

Pausing a wash program



Knock on the door 2 times

Cancelling a wash program with the door open



Press and hold ▶.

If there is any water in the drawer, it will automatically drain before the DishDrawer™ Dishwasher turns off.

- Holding ▶ for too long may activate **DELAYED START**. The delay start indicator will flash and a tone will sound to signal this. Refer to 'Cancelling Delayed Start' for details.

Cancelling a wash program with the door closed



Knock twice to pause the current cycle. Open the drawer and press and hold ▶.

WASH MODIFIERS

After setting a wash program, you can select one of the following additional options. Only one modifier can be set at a time.

DRY+

Increases the final rinse temperature and the length of the drying phase.

QUIET

Lowers the motor speed to reduce noise, ideal for open plan living and night use.

SANITIZE

Raises the water temperature during the rinse phase to sanitize.

WASH PROGRAM	MODIFIER AVAILABLE
AUTO	DRY+
HEAVY	DRY+, SANITIZE
MEDIUM	DRY+, SANITIZE, QUIET
LIGHT	DRY+
60MIN	DRY+
GLASSWARE	DRY+
ECO (default)	
RINSE	

Setting a wash modifier

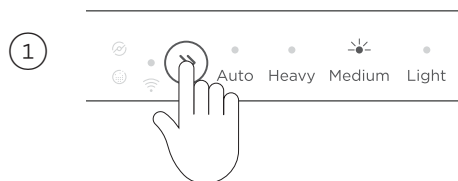

Ensure DishDrawer™ Dishwasher is turned on, detergent has been added and a wash program has been selected.



Press ★ to scroll through the available wash modifiers, the selected wash modifier indicator will illuminate on the display. Press ▶ to start the wash before closing the drawer.

WASH MODIFIERS

Using SANITIZE

The **SANITIZE** wash modifier adjusts the wash program to meet the conditions required by Section 6, NSF 184 for sanitization to occur. While **SANITIZE** is running, the wash program is monitored to ensure that these conditions are met.

Only programs utilising the **SANITIZE** wash modifier are certified to meet the conditions required by Section 6, NSF 184. Other wash programs may not reach the temperatures required for sanitization to occur. See table on previous page for wash programs that have sanitize available.

For sanitization to occur, the temperature of the water may need to reach 70°C. Ensure all items are dishwasher safe before running the sanitize modifier.

If the wash is interrupted or the water supply is turned off during the program, the heating conditions for sanitization may not be met. You may need to run the program again.



If sanitization has been successful

The wash will finish as normal.



If sanitization has not been successful

An alert will sound and when the drawer is opened the **SANITIZE** indicator will flash.

- ① Check if the water supply has been turned off or the wash program interrupted.
- ② Press and hold ► once to stop the beeping and then again to clear the alert code.
- ③ Reset **SANITIZE** and run the cycle again

For more information, refer to 'Fault codes'.

DELAYED START

Set the DishDrawer™ Dishwasher to start later in the day, and run the selected wash program. **DELAYED START** can be set after a wash program has been selected and can be set for up to 12 hours.

Setting Delayed Start

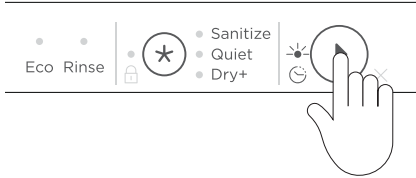

Press and hold ►, each tone indicates + 1 hour delay and can be set for up to 12 hours.

- If you scroll past 12 hours, the DishDrawer™ Dishwasher will exit **DELAYED START**.
- Countdown will begin when ► is released. The selected wash program will begin when countdown is complete, provided the drawer is closed.
- If the drawer is not closed within 7 seconds of setting **DELAYED START**, or the drawer is opened after it has been set, **DELAYED START** will be paused after closing the drawer. Press ► and close the drawer to resume.

Cancelling Delayed Start

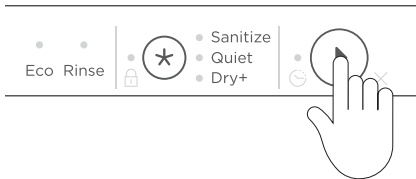

Press and hold ►.

If there is any water in the drawer, it will automatically drain before the DishDrawer™ Dishwasher turns off

KEYLOCK

The DishDrawer™ Dishwasher can be locked for cleaning and to prevent unintended use. When the control panel is locked the controls will remain unresponsive. To lock the drawer, refer to 'Preferences'.

Lock DishDrawer™ Dishwasher



Open the drawer and press and hold ★ until a tone sounds and the lock indicator begins flashing.

Lock DishDrawer™ Dishwasher while washing

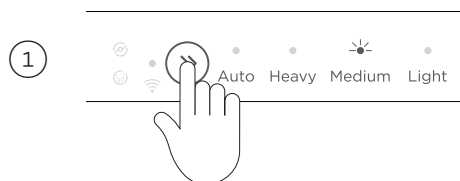

Select the desired wash program.



Press and hold ★ until a tone sounds and the lock indicator begins flashing.



Press ► within 10 seconds and close the drawer to begin the wash.

- If a program is not started within 10 seconds, the control panel will lock and the wash program will not begin.

Unlock DishDrawer™ Dishwasher



With door open

Press and hold ★ until the lock indicator dims.

With door closed

Knock on the door 3 times until a tone sounds

DETERGENT

WARNING: Dishwasher detergents are strongly alkaline. They can be extremely dangerous if swallowed. Avoid contact with the skin and eyes and keep children and infirm persons away from the dishwasher when it is open. Check the powdered detergent dispenser is empty after each wash.

Unsuitable detergents

These types of detergent are not suitable and may damage your DishDrawer™ Dishwasher and lead to a service call that is not covered by warranty:

- Liquid detergents
 - Soaps
 - Laundry detergents
 - Disinfectants
 - Hand washing liquids
-

Using powdered detergent

Do not place tablets or pouches in the dispenser. Refer to the following 'Powdered detergent quantity recommendations' table and the detergent manufacturer's guidance. No detergent is needed for **RINSE**.

1

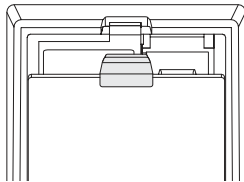

Press the latch down to open the dispenser. Check that the dispenser is empty and dry.

2

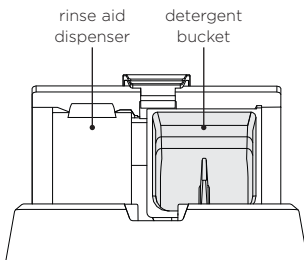

Add powdered detergent to the detergent bucket and close the cover gently until it clicks shut.

The detergent will automatically be released into the drawer during the wash program.

When washing heavily soiled dishware in hard water, more detergent may be required. Refer to 'Powdered detergent quantity recommendations'.

DETERGENT

Using solid tablets or pouches

Using tablets could improve wash performance in hard water areas. Follow manufacturer guidance. Some tablets or pouches may not be suitable for all wash programs.

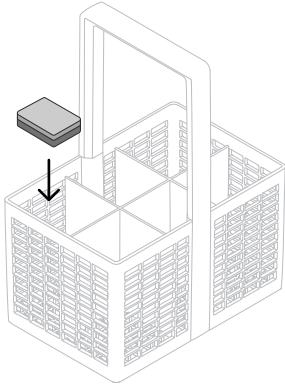

Place in cutlery basket

Place tablet or pouch in cutlery basket, ensuring it doesn't come in direct contact with dishes or cutlery.

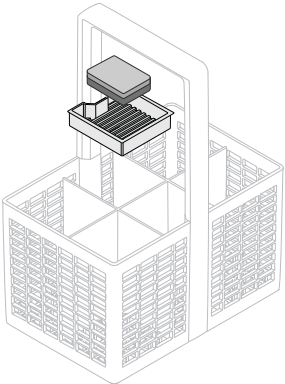

Place on tablet tray

Place tablet or pouch on tablet tray in cutlery basket ensuring it doesn't come in direct contact with dishes or cutlery.

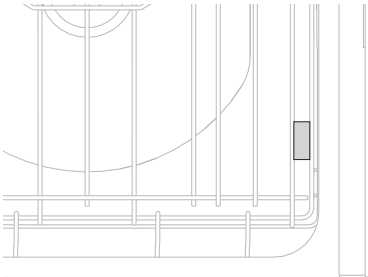

Place directly in tub

Place the tablet or pouch between the racking at the side as shown.

Do not place on the base of the drawer as it may interfere with the spray arm rotation and affect wash performance.

DETERGENT

Powdered detergent quantity recommendations

The recommended detergent quantity depends on water hardness and the soil level of your dishes. Use the table below to determine the optimal powdered detergent quantity based on water hardness and soil level. Refer to 'Wash program' descriptions to select a program for soil level.

WATER HARDNESS		SOIL LEVEL	POWDER QUANTITY PER DRAWER		TABLET
SOFT	<100PPM	LIGHT	10g	1/3	Not recommended
		MEDIUM	20g	2/3	OK
		HEAVY	30g	Full	OK
MODERATE	100-250PPM	LIGHT	20g	2/3	Not recommended
		MEDIUM	20g	2/3	OK
		HEAVY	30g	Full	OK
HARD	>250PPM	LIGHT	30g	Full	OK
		MEDIUM	30g	Full	OK
		HEAVY	>30g	Full*	OK

*Additional detergent can be added directly into base of tub, below the dispenser.

RINSE AID

Rinse aid provides a streak-free finish to glass and dishware as well as preventing metal from tarnishing. We recommend using a liquid rinse aid regularly for optimal drying results. During dispensing, several pulsing sounds may be heard. This is normal.

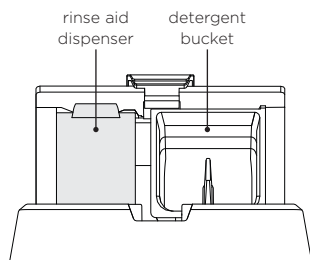

The rinse aid dispenser is located on the inside of the drawer next to the detergent dispenser. It holds approximately 80ml of rinse aid.

Using rinse aid

The amount of rinse aid dispensed in each wash may need adjusted to suit your water conditions. Refer to 'Preferences' for guidance. If using powdered detergent, we recommend filling the rinse aid dispenser before adding detergent.

1

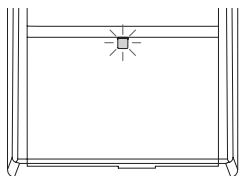

Check the rinse aid indicator:

- If indicator is bright red, refill rinse aid.
- If indicator is dim, a refill is not required.

2

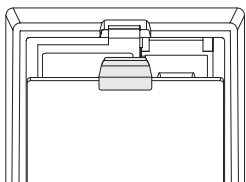

Press the latch down to open the dispenser before lifting the rinse aid cover.

3

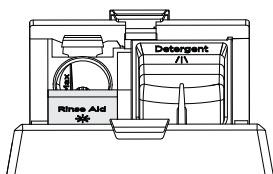

Lift the cover open and pour rinse aid into the opening taking care not to spill any into the drawer or detergent bucket.

Close the cover until it clicks shut.

Any accidental spillages into the tub or detergent bucket must be cleaned up immediately. Spilt rinse aid may result in excessive foaming. A service call relating to these errors will not be covered by warranty.

WATER HARDNESS

Water hardness recommendations

- Use the table below to determine the optimal water hardness setting. Your local water company will be able to help.
- If you have a household water softener installed, use the setting recommended for water with a hardness under 100 ppm/6 gpg, irrespective of the water hardness in your area.
- If your water hardness is above 625 ppm/36 gpg, the wash performance of your DishDrawer™ Dishwasher will decline over time. The rinse aid setting should be at 5.

SETTING	WATER HARDNESS SCALES					
	PPM*	GPG**	°DH	°FH	°E / °CLARK	MMOL/L
0	0-100	0-6	0-5.6	0-10	0-7	0-0.1
1	100-250	6-14	5.6-14	10-25	7-17.5	0.1-2.5
2	250-350	14-20	14-19.6	25-35	17.5-24.5	2.5-3.5
3	350-450	20-26	19.6-25.2	35-45	24.5-31.5	3.5-4.5
4	450-550	26-32	25.2-30.8	45-55	31.5-38.5	4.5-5.5
5	550-625	32-36	30.8-35	55-62	38.5-43.8	5.5-6.2

PREFERENCES

You can adjust any of the settings of the below options prior to starting a wash cycle.

Wi-Fi

Allows your DishDrawer™ Dishwasher to connect to your home network. Refer to 'Wi-Fi connection & remote mode' for details.

Rinse aid

Controls the amount of rinse aid dispensed. Refer to 'Rinse aid' for details.

Auto power-on*

Your DishDrawer is set to automatically power on for 30 seconds after a drawer is

opened. This can be turned off.











Tones

Adjusts tone settings. When set to **OFF** all tones will be silenced except fault alerts.

Auto lock

Allows the drawer to automatically lock 30 seconds after it's closed.

Settings displays

OPTION	DISPLAY	SETTINGS
Wi-Fi	<ul style="list-style-type: none"> • Sanitize • Quiet • Dry+ 	Disconnected 
		Connected 
Rinse aid	<ul style="list-style-type: none"> • Sanitize • Quiet • Dry+ 	Off • Auto • Heavy • Medium • Light • 60min
		Max: 5     
Auto power-on*	<ul style="list-style-type: none"> • Sanitize • Quiet • Dry+ 	Off • Auto • Heavy • Medium • Light • 60min
		On  • Auto • Heavy • Medium • Light • 60min
Tones	<ul style="list-style-type: none"> • Sanitize • Quiet • Dry+ 	Off • Auto • Heavy • Medium • Light • 60min
		On  • Auto • Heavy • Medium • Light • 60min
Auto lock	<ul style="list-style-type: none"> • Sanitize • Quiet • Dry+ 	Off • Auto • Heavy • Medium • Light • 60min
		On  • Auto • Heavy • Medium • Light • 60min

*Suitable as a Sabbath option.

PREFERENCES

Changing the settings

1

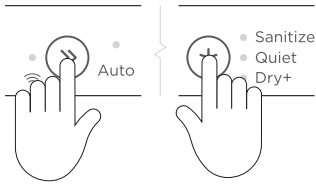

Ensure there is no wash in progress, then open the drawer. Press and hold » and ★ together for four seconds.

2

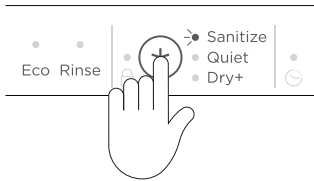

Press ★ to scroll through the settings. The wash modifier indicators will display which setting is selected. Refer to 'Settings displays' for details.

3

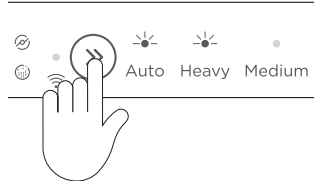

Press » to change the setting within an option. The wash program indicators will display which setting is selected. Refer to 'Settings displays' for details.

4

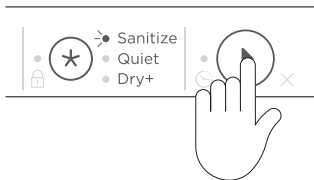

Press ► to save the new setting and leave the menu. If at any time, you want to exit the menu, press and hold ► to cancel.

Double models

Changing the settings in one tub will set your preferences for both drawers.

WI-FI CONNECTION & REMOTE MODE

Your appliance can be connected to your home wireless network and operated remotely using the app.

Getting started

- Ensure your home Wi-Fi network is turned on.
- You will be given step by step guidance on both your appliance and mobile device.
- It may take up to 10 minutes to connect your appliance.
- For further guidance and troubleshooting, please refer to the app.

On your mobile device:

- ① Download the app from www.fisherpaykel.com/connect
- ② Register and create an account.
- ③ Add your appliance and set up the Wi-Fi connection.

Connecting to your home Wi-Fi

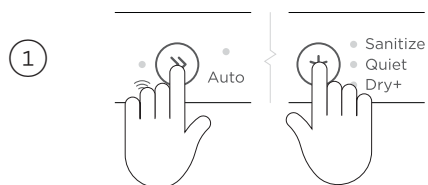

Ensure there is no wash in progress, then open the drawer. Press and hold » and ★ together for four seconds.

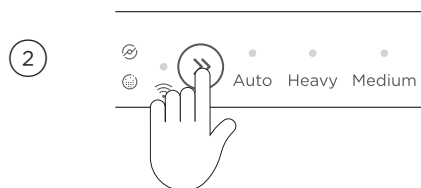

Press and hold » to connect to the Wi-Fi network.

Alternatively press ★ to scroll to the Wi-Fi menu, then press and hold » to connect. When 📶 flashes, follow the prompts within the app to complete set-up.

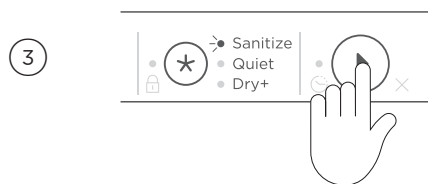

Press ► to save and leave the menu after Wi-Fi is connected. If at any time, you want to exit the menu, press and hold ► to cancel.

WI-FI CONNECTION AND REMOTE MODE

Enabling remote mode

1

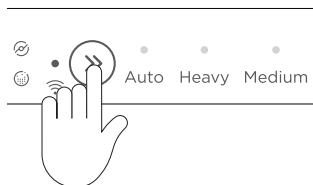

With your DishDrawer™ Dishwasher connected to your Wi-Fi network, press and hold » for four seconds.

2



While  is flashing, close the drawer to enable **REMOTE MODE**.

If the drawer is not closed within 7 seconds, while  is flashing, **REMOTE MODE** will not be enabled.

Disabling remote mode

REMOTE MODE will automatically be disabled after 72 hours or if a fault occurs. Opening the drawer will also disable **REMOTE MODE**.

RACKING FEATURES

Cutlery basket

To reduce the risk of injury, we recommend loading knives and sharp utensils with handles facing up. Mix spoons, knives and forks within each section to stop cutlery nesting together and to ensure the water circulates freely. Keep stainless steel from touching silver cutlery to avoid staining.

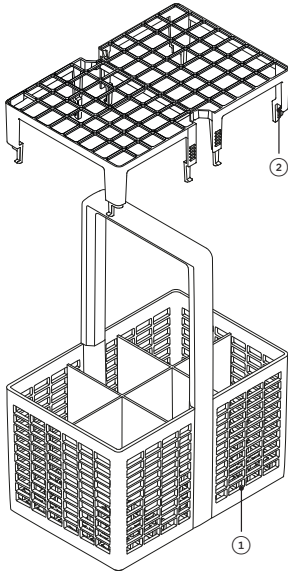

Cutlery basket features and accessories

- ① Cutlery basket
- ② Removable anti-nesting grid

Cutlery basket accessories

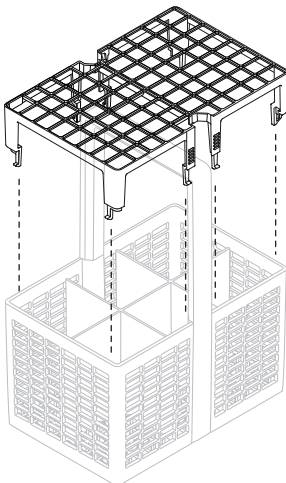

Removable anti-nesting grid

Use the anti-nesting grid to separate cutlery items and stop them from nesting together. The grid clips onto the top of the cutlery basket.

RACKING FEATURES

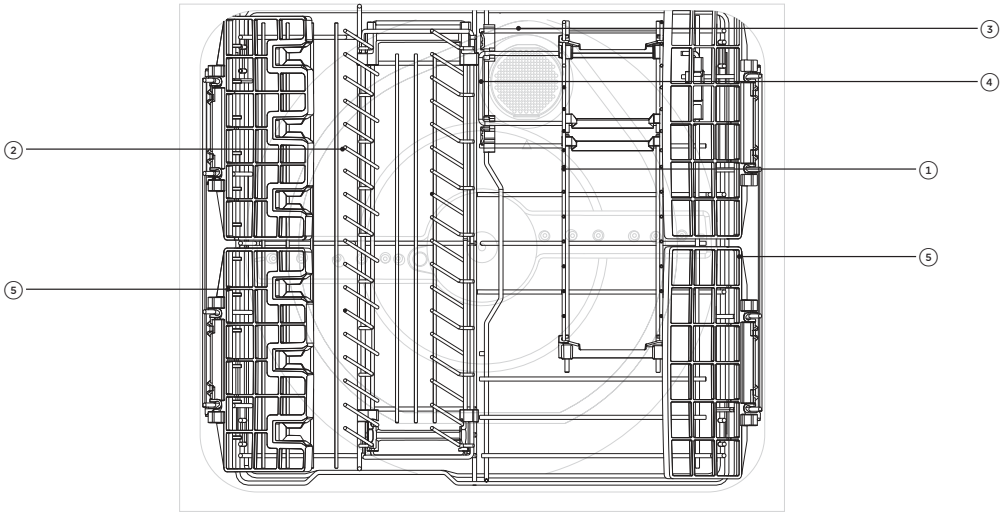

Racking features

- ① Folding tine rack
 - ② Adjustable tine rack
 - ③ Base rack
 - ④ Trap door
 - ⑤ Cup racks
- Not illustrated: glass supports

Base rack

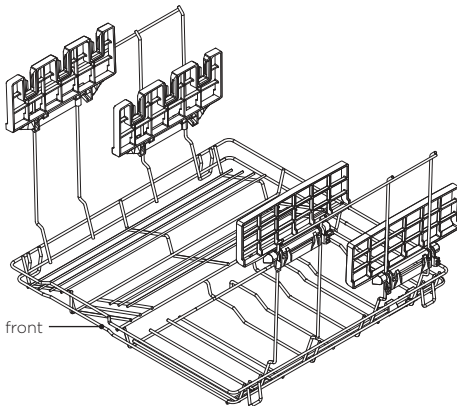

To remove

- ① Fold the front cup racks up, and lift to their highest position.
- ② Fold the rear cup racks up and lower to their lowest position.
- ③ While holding the wire cup rack supports inward so the top bar clears the side, carefully lift and tilt the rack out towards you. Take care to lift the front around the dispenser and ensure that the front cup racks are clear of the corners of the flange.

To replace

- ① Ensure cup racks are oriented as above.
- ② Hold the cup rack supports and lower the rack down from each side taking care to lower the front around the dispenser.

RACKING FEATURES

Adjustable tine rack

This rack is designed to fit deep bowls or small plates by adjusting the spacing of the tines.

To adjust spacing

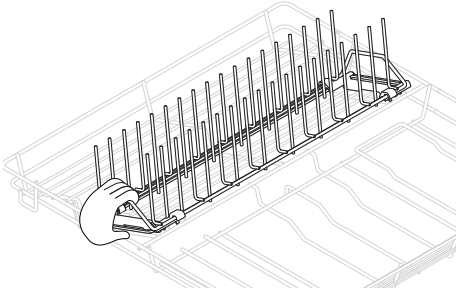

Slide the tines backward or forward by pushing or pulling the front handle.

To remove

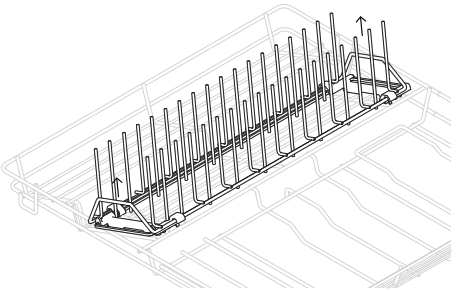

Grip the front and back handles and pull up to unclip.

To replace

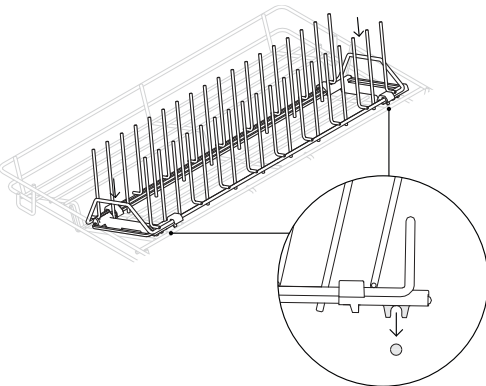

Align front and rear clips with the base rack and clip into place.

RACKING FEATURES

Folding tine rack

The folding tines can be removed if desired, however, it is recommended the tines are folded down rather than removed if more space required.

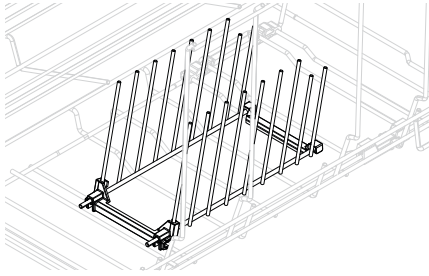

To remove

- ① Fold tines down towards each other.
- ② Unclip the rack at one end and pull firmly towards you.

To replace

- ① Line up the clips with the base rack.
- ② Push firmly to click rack into place.

Trap door

The trap door provides quick access to the filter for efficient care and cleaning.

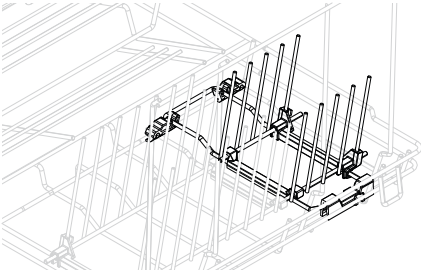

Using the trap door

- ① Fold down tines connected to trap door.
- ② Lift trap door open.

Glass supports

These removable clips provide extra stability when needed.

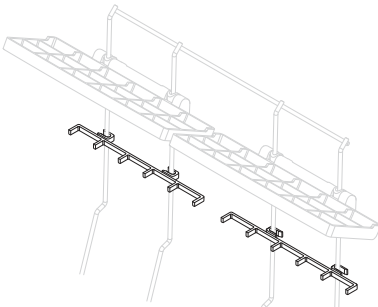

Using the glass supports

- ① Ensure supports are oriented as shown.
- ② Clip supports into position.

RACKING FEATURES

Foldaway cup racks

Each cup rack can be folded away independently to create more space within the drawer and are height adjustable. The cup racks on the left hand side have been designed to provide additional support for wine glasses via the wine grippers.

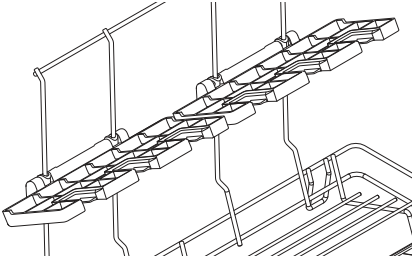

To adjust height

- ① Fold up to unlock the rack.
- ② Adjust the height to suit by sliding up or down.
- ③ Fold back down to lock in the position.

MAINTENANCE

Disconnect the DishDrawer™ Dishwasher from the power supply and allow it to cool before undertaking any cleaning or maintenance.

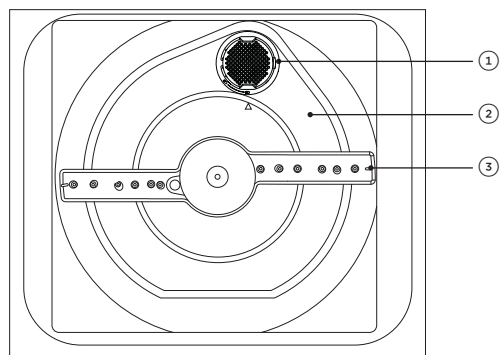

Tube features

- ① Filter
- ② Filter plate
- ③ Spray arm

Cleaning surfaces

Wipe with a damp cloth and dry using a lint-free cloth.

We do not recommend using the following cleaning aids as they may damage the surfaces:

- | | |
|--|---|
| <ul style="list-style-type: none">• Plastic or stainless steel scouring pads• Abrasive, solvent, household cleaners• Acid or alkaline cleaners | <ul style="list-style-type: none">• Hand washing liquids or soap• Stainless steel cleaners or polishes• Laundry detergents or disinfectants |
|--|---|

Cleaning the filter, spray arm and filter plate

We recommend that the filter in each drawer is removed and cleaned whenever the cleaning indicator illuminates or whenever there is evidence of food particles. The filter plate and spray arm should require cleaning less frequently during normal use. These parts can be shaken to remove any foreign material, cleaned in hot water, rinsed in clean water, then dried with a damp cloth.

The DishDrawer™ Dishwasher must be used with the filter plate, filter and spray arm correctly in place. We recommend that you always use the DishDrawer™ Dishwasher with the right hand fixed tine rack or folding tine rack in place.

If a dishwasher cleaner/descaler is used, you must run a wash program with detergent immediately afterward to prevent any damage to your DishDrawer™ Dishwasher.

Extended periods of disuse

If the DishDrawer™ Dishwasher is not going to be used for some time we recommend turning off the power and water supply, leaving it clean and empty with the drawers ajar.

When using your DishDrawer™ Dishwasher for the first time after a long period away, we recommend pouring 3 cups of water into the drawer before use. This helps lubricate components that may have dried out during dis-use.

MAINTENANCE

For ease of access to the filter, lift the trap door. Refer to 'Racking features' for details.

Removing and cleaning the filter

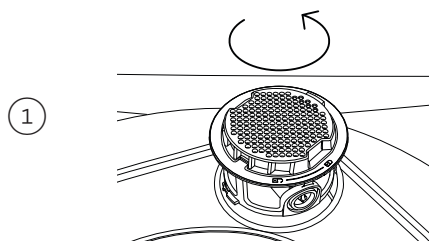

Twist the filter anti-clockwise until the arrow in the tub points to  on the filter. Lift to remove.

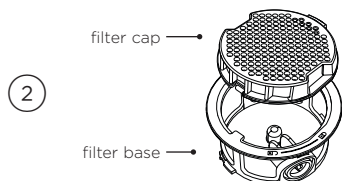

Separate the filter cap from the filter base by pressing the release button and lifting.

Do not attempt to remove the filter by force as this may cause damage.

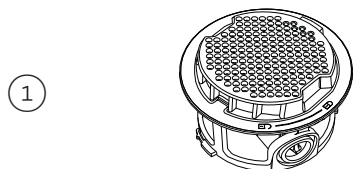

Clean under hot soapy water and rinse thoroughly.

Replacing the filter

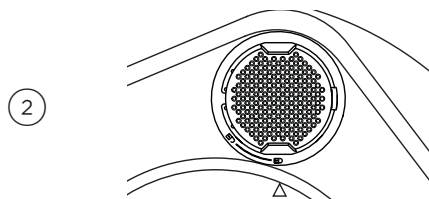

Align the filter cap with the notch on the filter base. Click together to secure.



Place the filter back into the tub by aligning the arrow to the  on the filter. Rotate clockwise until the arrow aligns with  and clicks into position.

If not aligned correctly, draining performance may be reduced.

MAINTENANCE

Removing and cleaning the spray arm

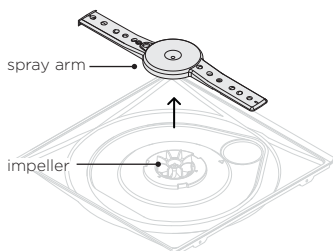

With racking removed, lift the spray arm off the impeller, pulling up from the centre. Shake to dislodge any loose particles, rinse under running water and wipe with a damp cloth. Ensure the magnet is clean and clear and that water can flow through all holes.

Refitting the spray arm

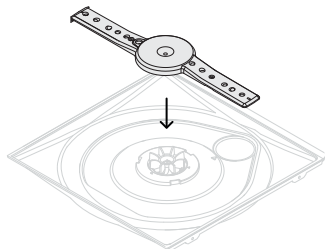

Place the spray arm onto the impeller. Ensure that the arm rotates freely when refitted.

Removing and cleaning the filter plate

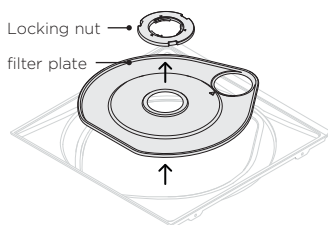

With the racking, drain filter and spray arm removed, twist the locking nut anti-clockwise and lift out. Carefully lift the filter plate out and clean under hot soapy water before rinsing thoroughly. Ensure the O-ring is still in place as illustrated below.

Refitting the filter plate

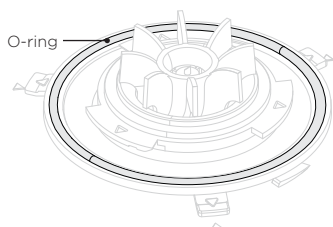

Before refitting the filter plate, ensure the O-ring is correctly positioned within the tub as shown. If the O-ring is incorrectly fitted before running a cycle, product damage may occur.

Push the filter plate back into the tub ensuring there are no particles in the recess. Secure in place by lowering the locking nut into position, pushing down and rotating clockwise until the arrows align.

MAINTENANCE

Winterizing (cold climates)

If the DishDrawer™ Dishwasher is installed in a cold climate where temperatures fall below zero, we recommend winterizing.

1

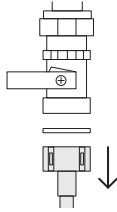

Turn off the water supply.

Disconnect the drain hoses from the sink drain pipe and the water inlet pipe from the water valve.

2

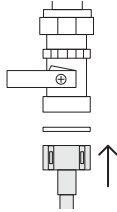

Drain the water from the hoses, inlet pipe and water valve, using a bucket or pan to collect the water.

Reconnect the water inlet pipe to the water valve and hoses to the sink drain pipe.

3

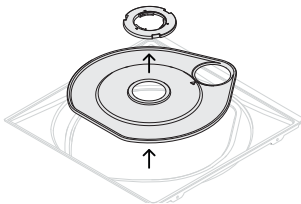

Remove the filter, spray arm, locking nut and the filter plate from the bottom of the drawer. Use a sponge to remove any remaining water from underneath before replacing.

MAINTENANCE ALERTS

Blocked spray arm

If the spray arm rotation is obstructed,  will flash and the current cycle will be paused.

Resolving blocked spray arm alert

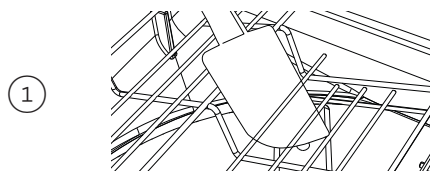



Ensure the spray arm can rotate freely and there are no protrusions below the rack.



Press  to clear the warning and resume the wash program.



If the alert is not resolved within 1 hour, the cycle will resume but wash performance will be reduced.  will continue to flash at the end of the cycle. Press  to clear the warning.

Filter

After a set amount of cycles have been run,  will flash indicating the filter should be cleaned. This will flash until the warning has been cleared.

Resolving filter alert

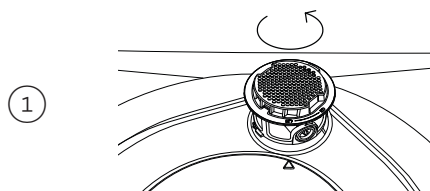



Clean the filter. Refer to 'Removing and cleaning the filter' for guidance.



Press and hold  for two seconds to clear the indicator.

TROUBLESHOOTING

PROBLEM	POSSIBLE CAUSES	WHAT TO DO
Unclean dishes	Unsuitable wash program for load selected.	Select the appropriate wash program for the load. Refer to 'Wash programs'.
	Drawer incorrectly loaded.	Refer to 'Loading suggestions'.
	Filter plate or filter incorrectly installed.	Refer to 'Removing and cleaning the filter'.
	Incorrect detergent use.	Refer to 'Detergent' and follow the detergent manufacturer's instructions.
	Excess food on dishware.	Remove all food scraps prior to loading.
	Spray arm holes blocked.	Clean the spray arm.
	Spray arm rotation blocked.	Remove any protrusions below the rack and ensure the spray arm can rotate freely.
	Hard water.	Increase the rinse aid setting and the amount of detergent used. Refer to 'Water hardness'.
Hard water		Increase the rinse aid setting and the amount of detergent. Refer to 'Water hardness'.
		If living in an area with very hard water, consult a plumber on installing a household water softener.
Foaming	Incorrect detergent use.	Refer to 'Detergent'.
	Egg left on plates.	Rinse excess egg prior to loading.
	Rinse aid setting too high.	Decrease the rinse aid setting.
 is flashing on the display	The spray arm rotation is obstructed.	Refer to 'Maintenance alerts'.
 is flashing on the display	Routine cleaning of the filter is due.	Refer to 'Maintenance alerts'.
Water leaking	Drain hose disconnected from waste pipe.	Reconnect the drain hose to the waste pipe.
	Water inlet hose not connected correctly.	Ensure the inlet hose is connected securely.
	Other leaks.	Turn water and power supplies to the DishDrawer™ Dishwasher off. Call Customer Care or your Authorised Service Centre.

TROUBLESHOOTING

PROBLEM	POSSIBLE CAUSES	WHAT TO DO
Knocking on the door doesn't pause the wash cycle	Knock to Pause sensor is incorrectly installed or calibrated.	Contact Customer Care.
DishDrawer™ Dishwasher is pausing inadvertently	Knock to Pause sensor is recognising taps and bumps as knocks.	Knock to Pause sensor is incorrectly installed or calibrated. Contact Customer Care.
Drawer will not open (no tones or wash in progress)	KEYLOCK is on.	Turn KEYLOCK off. Refer to 'Keylock'.
	Closed drawer auto lock is on.	Knock once on the door and open drawer within 30 seconds.
Power failure during wash program	Power outage in your home or area.	Wait until power resumes, program will restart in same part of wash program.
Flashing wash modifier indicators	A fault has occurred.	Refer to 'Fault codes'.
Intermittent beeping	DishDrawer™ Dishwasher is paused.	Open the drawer and press ►
DishDrawer™ Dishwasher will not start	Power supply is not connected.	Connect the power supply.
	The drawer is not closed correctly.	Ensure the drawer is firmly closed.
	KEYLOCK is on.	Turn KEYLOCK off. Refer to 'Keylock'.
	Cycle not started	Refer to 'Wash programs'.
	Too much time passed between pressing ► and closing the drawer.	Open the drawer and press ►, close the drawer within 7 seconds.
	DishDrawer™ Dishwasher is in Demo mode.	Contact Customer Care.
Fan noise after a wash program has finished	This is normal. The fan continues to run to assist with drying.	The fan will automatically stop after a set time, or when the drawer is opened. the fan may resume when drawer is closed again.
Fan noise starts when I close the drawer, even though I didn't start a new wash	This is normal. In some cases, the fan will run when the drawer is closed for a set time after a program has finished.	The fan will automatically stop after the set time is over.

TROUBLESHOOTING

PROBLEM	POSSIBLE CAUSES	WHAT TO DO
No powdered detergent dispensed	Detergent dispenser was wet when loaded.	Clean the dispenser and ensure it is dry before adding detergent. Refer to 'Detergent' for more information.
The wash seems to have finished, but the drawer will not open	The wash is still in progress. It is in a quiet phase that is needed for optimal performance.	No action required. The program will transition into a more audible phase after the quiet phase is over.
Water pooling on inner rim of drawer after a wash	This is normal condensation.	Wipe dry.
Water under the filter	This is normal.	No action required.
Excess water in the drawer	Drain hose(s) bent.	Straighten the drain hose(s).
	Blocked filters.	Refer to 'Maintenance'.
Water marks on the dishes	Rinse aid depleted.	Refill the rinse aid dispenser.
	Rinse aid setting too low.	Increase/turn on the rinse aid setting.
	DishDrawer™ Dishwasher overloaded/incorrectly loaded.	Refer to 'Loading suggestions'.
Dents or marks on the drawer interior	This is normal. Daily use may cause minor cosmetic dents.	Take care when loading the DishDrawer™ Dishwasher.
Drawer interior is stained	Some foods may stain the inside of the drawer.	Pre-rinse dishes before placing in the drawer. Alternatively, use RINSE after adding the dishes may minimise staining.

FAULT CODES

How do I know if there is a fault?

Your DishDrawer™ Dishwasher will beep continuously and the indicators on the control panel will light up and flash. There are two types of fault codes – 'F' and 'A'.

- If the wash modifier and lock indicators are flashing, it is a 'F' fault.
- If only the wash modifier indicators are flashing, it is an 'A' fault.
- With both F and A faults, one or more wash program indicators are also lit.

Double models only

- There may be a fault in one or both of the drawers and the fault codes may be different in each.
- If a fault occurs in one drawer only, you are still able to use the other drawer.

To fix a fault

First try to fix the issue and clear the code according to the steps in the following tables. If the problem persists:

- ① Note down the fault code.
- ② Contact Customer Care for support or to organise a visit by a service technician. Refer to the Service and Warranty document for contact details.

'F' fault codes





You may be able to clear the fault by resetting the DishDrawer™ Dishwasher, follow the steps below. When the flashing indicators have disappeared the fault has been reset and you can continue to use your DishDrawer™ Dishwasher.

DISPLAY	POSSIBLE CAUSE	WHAT TO DO
 <p>60min Glassware Eco Rinse Sanitize Quiet Dry+</p>	Fault on drawer	<ol style="list-style-type: none">① Press ► to stop the beeping, then again to turn the DishDrawer™ Dishwasher off.② Wait a few seconds. Press ► again to turn the DishDrawer™ Dishwasher back on.



FAULT CODES

'A' fault codes

Follow the steps below to try and fix the issue.

DISPLAY	POSSIBLE CAUSE	WHAT TO DO
 <p>Glassware Eco Rinse</p>	<p>A1: Water Supply fault.</p>	<ol style="list-style-type: none"> ① Ensure the water supply is turned on. ② Press ► once to stop the beeping, then again to clear the fault. ③ Press ► to resume the wash program.
<p>RINSE + all modifiers</p>	<p>A3: Drawer cannot drain: The filter may be clogged or installed incorrectly.</p>	<ol style="list-style-type: none"> ① Ensure the filter is clean and installed correctly. Refer to 'Removing and cleaning the filter' and 'Replacing the filter'. ② Press ► once to stop the beeping, then again to clear the fault. ③ Press ► to resume the wash program.
 <p>Glassware Eco Rinse</p>	<p>The drainage hose connection to kitchen drainpipe may be blocked.</p>	<ol style="list-style-type: none"> ① Ensure the drainage hose connection at sink trap, waste tee or standpipe is not blocked. ② Press ► once to stop the beeping, then again to clear the fault. ③ Press ► to resume the wash program.
<p>ECO, RINSE + all modifiers</p>	<p>A6: The spray arm has loosened or come off its mounting, or water pressure is too low, or a combination of low water pressure and excessive foaming.</p>	<ol style="list-style-type: none"> ① Open the drawer and check the spray arm. ② If the spray arm has loosened or come off its mounting, re-fit it. Check that it is firmly seated and turns freely. Refer to 'Maintenance'. ③ Press ► once to stop the beeping, then again to clear the fault. ④ Press ► to resume the wash program.
 <p>Glassware Eco Rinse</p>	<p>A7: Auto recovery program - DishDrawer™ Dishwasher has detected excess foam in the drawer.</p>	<ol style="list-style-type: none"> ① Let the auto recovery program run until it is complete. The wash program will resume when the auto recovery program has completed. ② Check that you are using the right detergent before running another wash program. ③ If the drawer is still filled with foam at the end of the wash program, contact Customer Care.
<p>GLASSWARE, ECO + all modifiers</p>	<p>A7: Auto recovery program - DishDrawer™ Dishwasher has detected excess foam in the drawer.</p>	
 <p>Glassware Eco Rinse</p>		
<p>GLASSWARE, ECO + RINSE + all modifiers</p>		

FAULT CODES

DISPLAY	POSSIBLE CAUSE	WHAT TO DO
 <p>Glassware Eco Rinse</p> <p>Current wash program + SANITIZE</p>	<p>A09: Sanitize cycle hasn't met the temperature needed to sanitize dishes.</p>	<ol style="list-style-type: none"> ① Check if the water supply has been turned off or the wash program interrupted. ② Press ► once to stop the beeping, then again to clear the fault. ③ Run the sanitize cycle again.
 <p>60min Glassware Eco Rinse</p> <p>60MIN, ECO + RINSE + all modifiers</p>	<p>A11: Element has overheated due to soil build-up.</p>	<ol style="list-style-type: none"> ① Press ► once to stop the beeping, then again to clear the fault. ② Remove rack, spray arm, filter and filter plate to access element. Refer to 'Maintenance.' ③ Clean element with a soft, damp cloth. Clean and refit rack, spray arm, filter and filter plate. Refer to 'Maintenance.' ④ Run medium cycle with detergent and no dishes. ⑤ Clean filter regularly to prevent reoccurrence.

WARRANTY AND SERVICE

Before you call for service or assistance

Check the things you can do yourself. Refer to the installation instructions and your user guide and check that:

- ① Your product is correctly installed.
- ② You are familiar with its normal operation.

If after checking these points you still need assistance or parts, please refer to the Service & Warranty book for warranty details and your nearest Authorised Service Centre, Customer Care, or contact us through our website www.fisherpaykel.com.

Requirements of EEC Directive 93/68

European directive 2012/19/EU on Waste Electrical and Electronic Equipment (WEEE) (for European Union countries only)

GB: This appliance is marked according to the European directive 2002/96/EC on Waste Electrical and Electronic Equipment (WEEE). By ensuring this product is disposed of correctly, you will help prevent potential negative consequences for the environment and human health, which could otherwise be caused by inappropriate waste handling of this product.

The symbol  on the product, or on the documents accompanying the product, indicates that this appliance may not be treated as household waste. Instead it shall be handed over to the applicable collection point for the recycling of electrical and electronic equipment. Disposal must be carried out in accordance with local environmental regulations for waste disposal. For more detailed information about treatment, recovery and recycling of this product, please contact your local city office, your household waste disposal service or the shop where you purchased the product.

Complete and keep for safe reference:

Model _____

Serial No. _____

Purchase Date _____

Purchaser _____

Dealer _____

Suburb _____

Town _____

Country _____

FISHERPAYKEL.COM

© Fisher & Paykel Appliances 2023. All rights reserved.

The models shown in this guide may not be available in all markets
and are subject to change at any time.

The product specifications in this guide apply to the specific products and
models described at the date of issue. Under our policy of continuous product
improvement, these specifications may change at any time.

For current details about model and specification availability in your country,
please go to our website or contact your local Fisher & Paykel dealer.

592426B 09.23