

Series 11, Integrated Tall Single DishDrawer Dishwasher

Series 11 | Integrated

Panel Ready



<p>Place anywhere in your kitchen at bench height for easy loading and seamless integration. Features a premium stainless steel interior.</p>

- Eight wash cycles from Heavy to Light, including Auto, 60min and Glassware
- Fits full-size dinner plates up to 12 1/4 inches, with flexible racking for large cookware

- With a soft-close drawer, and knock to pause convenience
- Wi-Fi capability and a SmartHQ™ app for remote control and notifications

DIMENSIONS

Height	17 7/8 "
Width	23 9/16 "
Depth	21 3/4 "

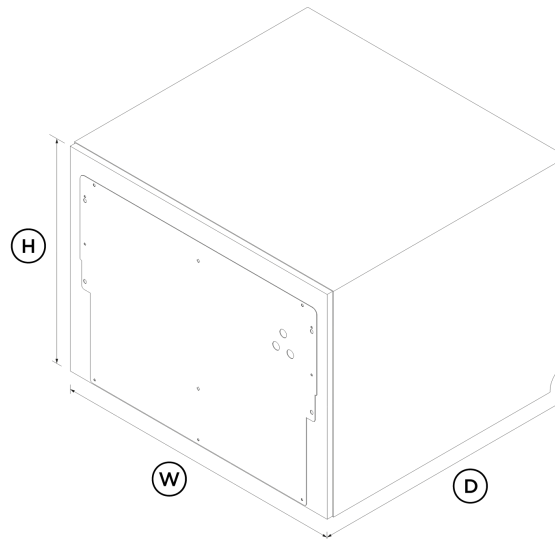

FEATURES & BENEFITS

Seamless Integration

With the flexibility of ergonomic placement and function, single DishDrawer™ Dishwashers can be distributed throughout the kitchen to support patterns of use. The touch-sensitive control panel is located inside this Integrated model, leaving an uninterrupted exterior that blends seamlessly with surrounding cabinetry.

Ease Of Use

DishDrawer™ Dishwashers are beautiful to use with soft-close drawers, and can be conveniently positioned at bench height for ease of loading and minimal bending. Flexible racking includes height-adjustable cup racks and wine glass supports.

Flexible Wash Options

Eight wash programs including Auto, 60min and Glassware, while modifiers such as Sanitize, Dry+ and Quiet provide added wash flexibility. The Quiet wash modifier reduces the noise on some cycles while maintaining performance - perfect for late night washing.

Design Quality

Every detail has been carefully crafted using quality materials, from the easy-to-clean stainless steel interior to the spray arm sensor that detects jams for increased wash confidence.

Knock To Pause

For ease-of-use, these DishDrawer™ Dishwashers have a knock to pause function. A knock on the front panel will pause the dishwasher, which can be restarted by using the start button.

Quiet Performer

Running at a low decibel rating of 43dBA, these DishDrawer™ Dishwashers do their job without making a fuss. The combination of intelligent technology and simple mechanics means greater reliability and excellent wash performance.

Efficient Performance

Our Energy Star rated DishDrawer™ Dishwashers use the energy they need without compromising on wash performance.

- Place settings **7**
- Wine glass supports with stemware grippers •

- SmartDrive™ technology •
- Soft close drawer •

SPECIFICATIONS

Accessories (included)

- Cutlery basket •
- Knife clip and multipurpose clip •

Accessories (sold separately)

- Door panel stainless steel **ADDD24STPX**
- Handle kit Classic **AHCL-DDD-24X**
- Handle kit Contemporary round, aluminium **AHS-OBDD-60S**
- Handle kit Contemporary square fine, aluminium **AHD5-OBDD-60SX**
- Handle kit Contemporary square fine, black **AHD5-OBDD-60SB**
- Handle kit Contemporary square, aluminium **AHD3-OBDD-60S**
- Handle kit Professional round flush **AHP3-DWDD-SX**
- Handle kit Professional round flush, Brass off-stands **AHP3DDD-24BA**
- Handle kit Professional round flush, Dark Copper off-stands **AHP3DDD-24DC**

Capacity and loading

- Accommodates round plates up to **12.25"**
- Adjustable height, foldable cupracks •
- Fold down tines •
- Pitch adjustable tines •
- Place settings **7**

Consumption

- Energy usage **154kWh/year**
- In-use energy carbon emissions estimate **19.0kgCO2e/year**
- Water usage (per wash cycle) **1.8 gal**

Controls

- Electronic fault/Diagnostic indicator •
- End of cycle beeps •
- Energy saving delay start option of up to 12 hours •
- Internal wash selector •
- Intuitive capacitive touch controls •
- Keylock •
- Knock to pause •
- Rinse aid indicator light •
- Smart appliance •
- Spray arm sensing •
- Wi-Fi connectivity •

Features

- Built-in water softener •
- Fan assisted drying •
- Flood protection •
- Flow through detergent dispenser •
- Internal tub material **Stainless Steel**
- Quiet operation •

Performance

- Noise emissions **43 dBA**

Power requirements

- Amperage **5A**
- Rated current **15 A**
- Supply frequency **60Hz**
- Supply voltage **100 - 120V**

Product dimensions

- Depth **21 3/4 "**
- Height **17 7/8 "**
- Width **23 9/16 "**

Safety and compliance

- ADA compliant •

Warranty

- Parts and labor **Limited 2 years**

Wash Program Modifiers

- Dry + •

Quiet	•
Sanitise	•
Wash modifiers	3

The product dimensions and specifications in this page apply to the specific product and model. Under our policy of continuous improvement, these dimensions and specifications may change at any time. You should therefore check with Fisher & Paykel's Customer Care Centre to ensure this page correctly describes the model currently available. © Fisher & Paykel Appliances Ltd 2020



A PEACE OF MIND SALE
24 Hours 7 Days a Week Customer Support
 T 1.888.936.7872 W www.fisherpaykel.com

Wash Programs

60 min	•
Auto	•
Eco	•
Glassware	•
Heavy	•
Light	•
Medium	•
Rinse	•
Wash programs	8

Other product downloads available at fisherpaykel.com

- [↓](#) Wash Program Data Sheet
- [↓](#) Energy Label Integrated Single DishDrawer™ Dishwasher
- [↓](#) Service & Warranty
- [↓](#) Installation Guide DishDrawer™ Dishwasher Venting Kit EN
- [↓](#) Planning Guide Integrated Single DishDrawer™
- [↓](#) Planning Guide Professional Style Dial/Handle Accessories
- [↓](#) User Guide DishDrawer™ Dishwasher EN
- [↓](#) Guide d'utilisation FR
- [↓](#) Wash Program Data Sheet EN

Water connection

Inlet water temperature	max 140 °F
Supplied hose to suit 3/8" (9mm) male compression fitting	•
Water pressure	100kPa - 1000kPa
Water supply	3/8" to suit Male Compression Fitting

Where applicable:

All appliances use energy, and energy usage typically generates carbon emissions. **Fisher & Paykel Appliances' In-use Energy Carbon Emissions Estimate** indicates carbon emissions from a product's in-use energy. This is calculated either annually or per cycle, using the product's market-specific energy label energy consumption data multiplied by the carbon emissions factor for energy in your country or region.

Our In-use Energy Carbon Emissions Estimate is designed to assist customers in making informed purchasing decisions when comparing different Fisher & Paykel products. For example, a heat pump dryer typically has a lower In-use Energy Carbon Emissions Estimate than a vented dryer.

SKU	82166
-----	-------