

FISHER & PAYKEL

**WALL RANGEHOOD,
120CM, BOX CHIMNEY**

**MINIMAL / CONTEMPORARY
HC120BCX2**

USER GUIDE / INSTALLATION GUIDE

CN HK SG

431315A 05.23

FISHER & PAYKEL

**WALL RANGEHOOD,
120CM, BOX CHIMNEY**

**MINIMAL / CONTEMPORARY
HC120BCX2**

**USER GUIDE
CN HK SG**

CONTENTS

Safety and warnings	4
Using your rangehood	6
Control panel	7
Care and cleaning	8
Troubleshooting	11
Manufacturer's Warranty	13
Customer care	14

This product complies with mandatory national energy efficiency standard: GB 29539-2013, scan the QR code on the energy label to obtain information on product energy registration.

Registration

To register your product visit our website: fisherpaykel.com/register

⚠ WARNING!



Electric Shock Hazard

Failure to follow this advice may result in electric shock or death.

- Always disconnect the appliance from the mains power supply before carrying out any maintenance or repairs. Failure to do so can result in death, electric shock, fire or injury to persons.
- Do not immerse cord or plugs in water or other liquid.
- Never touch the power plug or electrical components, or manipulate the power switch with wet hands.
- When cleaning, never allow electrical components such as the motor, switch and connectors to get wet.

⚠ WARNING!



Weight Hazard

Failure to follow this advice may result in personal injury.

- The appliance is heavy. Please ensure adequate care is taken when installing the appliance to prevent personal injury. The appliance must be installed onto a solid wall, stud, beam or truss.
- **Product weight:** 27kg

SAFETY AND WARNINGS

READ AND SAVE THESE INSTRUCTIONS

WARNING!

When using this appliance always exercise basic safety precautions including the following:

- Disconnect the power supply when cleaning or inspecting the product.
- Do not damage or place heavy objects on the power cord.
- The room must have adequate ventilation when the rangehood is used at the same time as appliances burning gas or other fuels. (A partial vacuum in the room could result in too high a concentration of gas in the air).
- Never expose the rangehood to a burner or element that is turned on without a pot or pan covering it.
- Never use aluminium foil on the cooktop.
- This appliance is not intended for use by persons (including children) with reduced physical, sensory or mental capabilities, or lack of experience and knowledge, unless they have been given supervision or instruction concerning the use of the appliance by a person responsible for their safety.
- Children should be supervised to ensure they do not play with the appliance. Cleaning and user maintenance shall not be made by children without supervision.
- You must read the details concerning the method and frequency of cleaning.
- There is a fire risk if cleaning is not carried out in accordance with the instructions.
- Never leave frying food unattended since grease can overheat and catch fire. The risk of fire is even greater in the case of used oil.
- Do not flambé under the rangehood.
- Never use the rangehood without the filters in place.
- CAUTION: accessible parts may become hot when used with cooking appliances.
- Remove all packaging, including protective wrappings, before use.
- Unplug or disconnect the appliance from the power supply before servicing or cleaning.
- The rangehood may stop working during an electrostatic discharge (eg lightning). Switch off the electricity supply to the rangehood and reconnect after one minute.
- Never use abrasive or oil based cleaners.
- Do not clean the inside of the range hood. If you need to clean the inside, please contact your Fisher & Paykel trained and supported service technician.
- The appliance shall be able to work normally under the following environmental conditions: temperature -15°C ~ 40°C, relative humidity ≤90% (at 25°C), altitude ≤1000m.

USING YOUR RANGEHOOD

This rangehood should be turned on for a few minutes before cooking in order to establish air currents upward through the rangehood. This will also enable hot air removal from your kitchen and keep the rangehood surface cool. When heat, smoke, moisture, grease and cooking odours are produced, they will be carried outside instead of drifting into other rooms.

Use the low fan speeds for normal use and the higher fan speeds for high heat, strong odours or fumes.

Induction cooking considerations

Induction cooktops use energy efficient technology that only heats the contents of a cooking pot. Unlike gas or traditional electric cooktops, the surrounding air does not get heated when using an induction cooktop. As a result, rangehood filters, splashbacks and surrounding cabinetry do not get warmed up, increasing the likelihood of condensation on these cooler surfaces. Other factors like ambient temperature, humidity, natural ventilation of the room, size of the cookware and how the induction cooktop is being used also influence condensation. For example, rapid boiling on high cooktop heat settings like PowerBoost increases the rate at which water is evaporated, increasing the likelihood of condensation. It is important to understand that neither the rangehood nor the induction cooktop are faulty as a result of this phenomenon.

Condensation can be minimised by:

- Using the rangehood on a lower speed setting when boiling.
- Using the induction cooktop on a lower heat setting when boiling.
- Switching the rangehood on 5 minutes before cooking and letting it run for at least 5 minutes after cooking.

Gas cooking considerations

Using a powerful gas cooktop or multiple gas burners operating at the same time can cause the rangehood surfaces to become hot. This effect can be reduced by:

- Using the maximum speed setting to enable hot air to be extracted quickly.

CONTROL PANEL

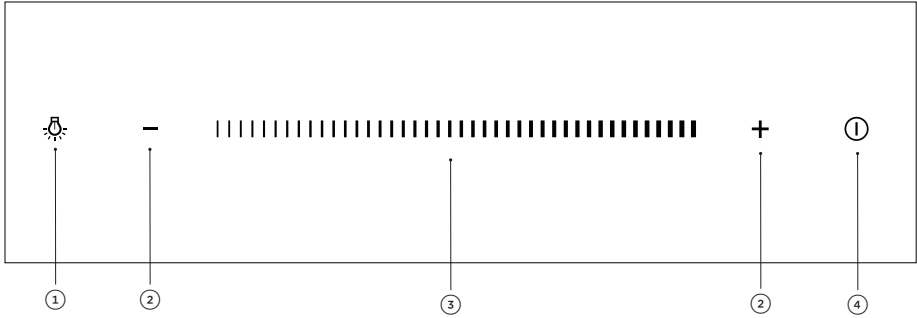

① Light	Press to turn light on/off.
② Fan speed	Press to turn the fan on and to cycle through the fan speeds. (Total 21 speed cycles) Holding + enters boost mode.
③ Fan speed adjust bar	Touch and slide to increase or decrease the fan speed.
④ Power on/off	Press to turn the rangehood on/off. The fan automatically turns on to operate at speed 15. When turning the rangehood off, the fan will continue to operate for 3 minutes. Press a second time to turn the fan off immediately.

CARE AND CLEANING

This rangehood should be cleaned regularly using a mild, liquid detergent and a clean soft cloth to avoid a build-up of grease occurring. Avoid the use of corrosive chemicals especially those made up of an acid base, abrasive cleaning products, hard brushes and steel wool pads. Grease deposits are corrosive which can cause damage.

In areas of high humidity or coastal environments, cleaning should be carried out more frequently. Disconnect the product from the power source before undertaking any cleaning.

The entire unit should be cleaned once every six months to maintain venting performance. Always wear rubber gloves during cleaning and maintenance to guard against injury from sharp metal parts.

Do not operate the hood without the oil filter and oil receptacle in place.

Unplug the power cord if the rangehood will not be used for a long period of time.

Oil receptacle

Empty the oil receptacle regularly to avoid overflow.

Removing the oil receptacle

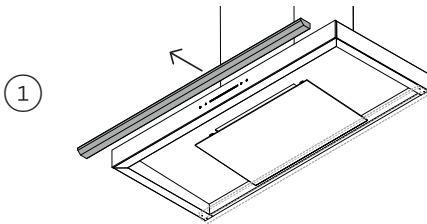

Pull the receptacle straight out to remove it from the rangehood.

Empty the oil receptacle and wash in warm water with detergent.

Replacing the oil receptacle

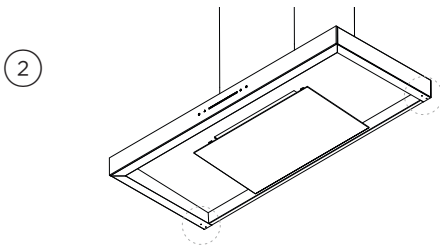

Position the oil receptacle between the tabs on the rangehood and slide back into place.

Ensure it is pushed all the way in.

CARE AND CLEANING

Oil filter

- Clean the filter and the filter recess at least once a month. It may need to be cleaned more frequently depending on the cooking methods used and frequency of use.
- The filter should be removed and left to soak in hot soapy water. After soaking, wipe clean with a rag and rinse with clean water.
- After rinsing and drying, refit the filters.

Removing the oil filter

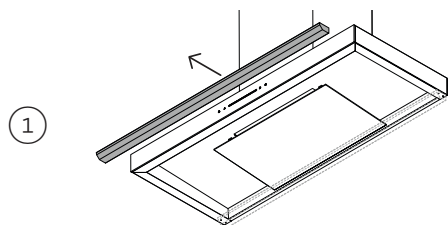

Remove the oil receptacle.

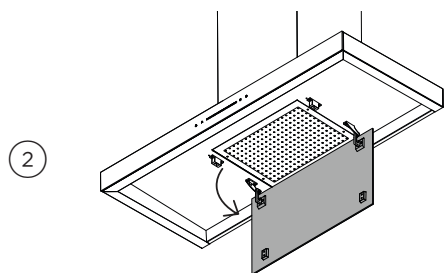

Unclasp and pull out the wind plate to locate the oil filter.

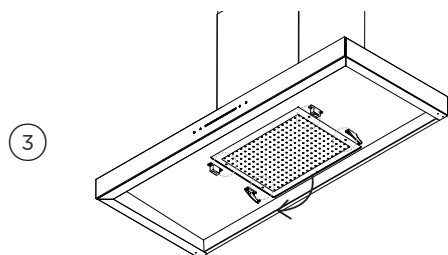

Loosen the 4 screws securing the oil filter and pull out to remove.

CARE AND CLEANING

Replacing the oil filter

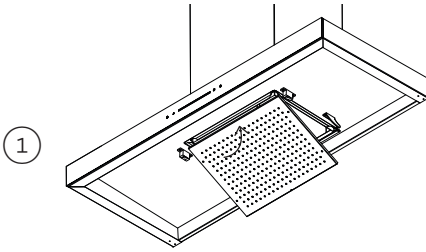

Insert the top edge of the filter into the filter recess. Ensure the tabs are aligned.

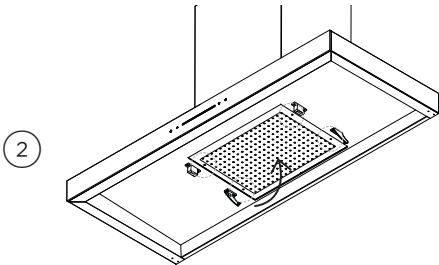

Push the rest of the filter back into place and tighten the screws to secure.

Replace the oil receptacle.

Fan

- Clean the fan regularly. It may need to be cleaned more frequently depending on the cooking methods used and frequency of use.
- The oil receptacle and oil filter should be cleaned once a month.
- Cleaning the fan will require two people to disassemble and reassemble the rangehood.
- Unplug the power before being disassembled.
- The fan should be removed and cleaned with hot soapy water. Do not wash the rangehood directly with water to avoid damage.
- Ensure that the clips on the fan blades are not moved or lost. This will imbalance the fan and can cause increased noise and vibration.
- After rinsing and drying, replace the fan and reassemble the rangehood parts.
- Do not unnecessarily touch the fan.
- Please note, it is recommended that the fan should be cleaned by a trained Fisher & Paykel technician.

TROUBLESHOOTING

If there is a problem with your rangehood, please check the following points before contacting your local Fisher & Paykel trained and supported service technician or the Customer Care Centre.

PROBLEM	POSSIBLE CAUSES	WHAT TO DO
No power.	Power supply plug is not plugged in or not properly connected.	Check the power plug is properly connected.
	No power is supplied to the electrical outlet.	Restore the power supply or contact an electrician.
	Power is not connected or a fuse has blown.	Reset the fuse or contact an electrician.
Product is not working.	Power supply is not connected or the voltage is incorrect.	Restore the power supply or contact an electrician.
	No fan speed has been selected.	Select a fan speed.
Light not working.	Light not turned on.	Press the light on control panel to turn on the light.
	Replacement bulb needed.	Contact Customer Care.
Excessive condensation forms on the rangehood.	Using an induction cooktop.	Condensation can be minimised, refer to 'Using your rangehood'.
	High ambient temperature, humidity or low natural ventilation in the room.	
	Height of rangehood installation.	
Rangehood makes a clicking noise after turning off.	Check valve blades settling back into place when there is no airflow.	This is normal.
Oil leak.	Too much oil in the oil receptacle.	Remove waste oil in the oil receptacle.
	Oil filter has not been cleaned.	Follow the instructions on cleaning the oil filter.
	Main housing hasn't been cleaned.	Wipe the main housing every day after use according to instructions.

TROUBLESHOOTING

PROBLEM	POSSIBLE CAUSES	WHAT TO DO
Oil filter is difficult to remove.	Filter and filter recess have not been cleaned.	Clean the filter and filter recess weekly in accordance with the instructions.
Rangehood is loud.	Main unit is not securely fastened to the wall.	Check that the main unit is fastened securely.
	Fan is not well fitted.	Fit the fan properly.
	Fan is damaged.	Replace the fan (contact Customer Care).
	Hand-tightened nut is loose.	Tighten the hand-tightened nut.
Airflow is lower than expected.	Rangehood body is not installed at the correct height.	Re-install the appliance at the required height.
	Universal ducting hose is too long, has not been stretched tight, or has too many bends.	Reduce the length of the ducting hose or the number of bends.
	Shared flue aperture is too narrow or the air outlet is poorly sealed.	Widen the flue aperture or improve the outlet sealing.
	The check valve blade is stuck and cannot function properly.	Fix the blade and ensure the valve is working correctly.
	Rangehood has not been cleaned.	Follow the rangehood cleaning instructions.

MANUFACTURER'S WARRANTY

You automatically receive a 2 year Manufacturer's Warranty with the purchase of this Rangehood covering parts and labour for servicing within the country of purchase.

Fisher & Paykel undertakes to:

Repair or, at its option, replace without cost to the owner either for material or labour any part of the product, the serial number of which appears on the product, which is found to be defective within TWO YEARS of the date of purchase.

Note: this Manufacturer's Warranty is an extra benefit and does not affect your legal rights.

This Manufacturer's Warranty DOES NOT cover

- Ⓐ Service calls which are not related to any defect in the product. The cost of a service call will be charged if the problem is not found to be a product fault. For example:
 - ① Correcting the installation of the product.
 - ② Instructing you how to use the product.
 - ③ Replacing house fuses or correcting house wiring or plumbing.
 - ④ Correcting fault(s) caused by the user.
 - ⑤ Noise or vibration that is considered normal, eg drain/fan sounds, refrigeration noises or user warning beeps.
 - ⑥ Correcting damage caused by pests, eg rats, cockroaches, etc
 - ⑦ Replacement light bulbs.
- Ⓑ Defects caused by factors other than:
 - ① Normal domestic use; or
 - ② Use in accordance with the product's user guide.
- Ⓒ Defects to the product caused by accident, neglect, misuse or 'act of God'.
- Ⓓ The cost of repairs carried out by non-trained and supported service technicians or the cost of correcting such repairs.
- Ⓔ Normal recommended maintenance as set out in the product's user guide.
- Ⓕ Repairs when the appliance has been dismantled, repaired or serviced by other than a Fisher & Paykel trained and supported service technician or the selling dealer.
- Ⓖ Pick-up and delivery.
- Ⓗ Transportation or travelling costs involved in the repair when the product is installed outside the Fisher & Paykel trained and supported service technician's normal service area.

Nothing in this manufacturer's warranty is intended to, or does, limit any rights you may have under law to recover the costs of inspecting or returning the goods to us.

This product has been designed for use in a normal domestic (residential) environment. This product is not designed for commercial use (whatsoever). Any commercial use by a customer will affect this product's Manufacturer's Warranty.

Service under this Manufacturer's Warranty must be provided by a Fisher & Paykel trained and supported service technician (refer to the 'Customer Care' section at the back of this book). Such service shall be provided during normal business hours. This Manufacturer's Warranty certificate should be shown when making any claim.

Please keep this user guide in a safe place.

CUSTOMER CARE

Before you call for service or assistance

Check the things you can do yourself. Refer to your user guide and check that:

- ① Your product is correctly installed.
- ② You are familiar with its normal operation.

If after checking these points you still need assistance or parts, please refer to your nearest Fisher & Paykel trained and supported service technician, Customer Care, or contact us through our local website listed on the back cover.

Call your Fisher & Paykel retailer/dealer from whom you purchased the product. They are trained to provide information on your appliance. If we can be of any further help, contact use on:

Phone: +64 9 273 0660

Fax: +64 9 273 0580

Website: fisherpaykel.com

Postal address: Fisher & Paykel Appliances Ltd, PO Box 58550, Botany, Auckland 2163, New Zealand.

CUSTOMER CARE

*If you call, write or contact our website please provide:
your name and address, model number, serial number, date of purchase and a complete description of the problem. This information is needed in order to better respond to your request for assistance.

**Product details can be found on the inside of the chassis.
The filter needs to be removed to be able to see them.**

Registration

Register your product with us so we can provide you with the best service possible.
To register your product visit our website: fisherpaykel.com/register

Complete and keep for safe reference:

Model	_____
Serial No.	_____
Purchase Date	_____
Purchaser	_____
Dealer	_____
Suburb	_____
Town	_____
Country	_____

FISHER & PAYKEL

**WALL RANGEHOOD,
120CM, BOX CHIMNEY**

**MINIMAL / CONTEMPORARY
HC120BCX2**

**INSTALLATION GUIDE
CN HK SG**

CONTENTS

Safety and warnings	4
Parts supplied	6
Prior to installation	8
Product dimensions	9
Installation height	11
Electrical requirements	13
Attach brackets and mounting screws	14
Hang rangehood	15
Connect ducting	16
Attach accessories	17
About your rangehood	18
Final checklist	19

⚠ WARNING!



Electric Shock Hazard

Failure to follow this advice may result in electric shock or death.

- Always disconnect the appliance from the mains power supply before carrying out any maintenance or repairs. Failure to do so can result in death, electric shock, fire or injury to persons.
- Altering of the internal wiring is strictly prohibited, unless performed by professional maintenance personnel.

⚠ WARNING!



Weight Hazard

Failure to follow this advice may result in personal injury.

- The appliance is heavy and requires two people for installation. Please ensure adequate care is taken when installing the appliance to prevent personal injury. The appliance must be installed onto a solid wall, stud, beam or truss.
- **Product weight:** 27kg

⚠ WARNING!



Cut Hazard

Failure to use caution could result in injury.

- Take care: some edges are sharp.
- Wear gloves to protect against sharp edges.

SAFETY AND WARNINGS

READ AND SAVE THESE INSTRUCTIONS

WARNING!

When using this appliance always exercise basic safety precautions including the following:

- Please read the entire set of instructions before installing or using this appliance.
- Please make this information available to the person installing the appliance – doing so could reduce your installation costs.
- Always switch the power off prior to installation, servicing or cleaning of the appliance.
- This appliance must be installed and connected to the mains power supply only by a suitably qualified person according to these installation instructions and in compliance with any applicable local building and electricity regulations. Failure to install the appliance correctly could invalidate any warranty or liability claims.
- To comply with electrical safety regulations, the appliance must be plugged into a socket near the appliance. The socket must be accessible, or have an accessible isolating switch, to enable the end user to isolate the appliance from the power for the purpose of internal cleaning or maintenance.
- Use a dedicated power outlet: the power cord must not be connected to an extension cord or multi-socket power board. Secure grounding is required, and the power cord should be 1000mm in length.
- If the supply cord of this equipment is damaged, it must only be replaced by the manufacturer, its service agent or similarly qualified person in order to avoid a hazard.
- All ducting must comply with local requirements and building codes.
- Attention should be given to ensure that any applicable regulations concerning the discharge of exhaust air are fulfilled.
- Before connecting any pipes, consult municipal ordinances to ensure that any applicable regulations concerning the discharge of exhaust air are adhered to and request permission from the person in charge of the building.
- If using shared ducting, the air outlet must be well sealed.
- Exhaust air must not be discharged into an existing flue that is used for exhausting fumes from appliances burning gas or other fuels.
- Stainless steel or powdercoat is very easily damaged during installation if abraded or knocked by tools. It is recommended to protect the top of the appliance with cardboard or polystyrene during the installation to minimise the risk of damage occurring.
- To reduce the risk of damage occurring to the cooktop, it is recommended that the surface of the cooktop is protected with cardboard or a similar object during installation of the rangehood.
- In order to avoid a hazard due to inadvertent resetting of the thermal cut-out, this appliance must not be supplied through an external switching device, such as a timer, or connected to a circuit that is regularly switched on and off by the utility.
- This appliance is an external exhaust hood, air and smoke is discharged to the outside through the air duct. To properly exhaust air, ensure the duct is straight.
- The minimum distance between the support surface of the cooking vessel on the cooktop and the lowest part of the range hood should be at least 650mm. If the cooktop installation instructions specify a larger installation distance, this should be considered.
- Installation should be performed by a qualified person. The appliance should be tested to confirm proper operation, and the correct use of the appliance should be explained to the user.

PARTS SUPPLIED

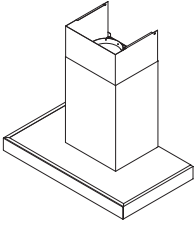

Rangehood
(1)



User guide and
Installation guide
(1)

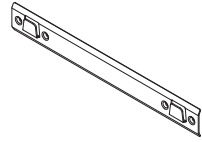

Wall bracket (1)

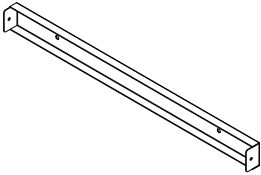

Upper chimney
bracket (1)

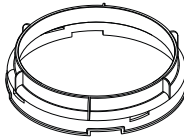

Check valve gasket
(1)

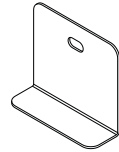

Safe block bracket
(1)

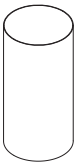

Universal ducting
hose 180 (1)

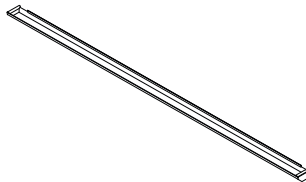

Oil receptacle
(1)

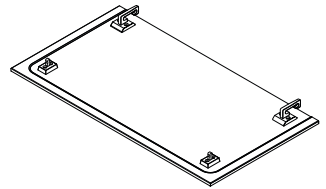

Wind plate
(1)

PARTS SUPPLIED



Self-tapping
screw ST4 x 8 (2)



Mounting screw*
4 x 48 (6)



Expansion plug*
10 x 48 (6)

* The screws and plugs are to be used in concrete or brick walls only. Different fixings will be required for other types of wall construction.

PRIOR TO INSTALLATION

Fisher & Paykel is not liable for any damage caused by not following these instructions.

- Please read the instructions carefully before installing the rangehood.
- Unpack the rangehood.
- Ensure the voltage (V) and the frequency (Hz) indicated on the rating plate match the voltage and frequency of the installation site.
- Check all functions are working.
- Check that the area behind the installation surface to be drilled is clear of any electrical cables or pipes etc.
- The rangehood surfaces can be damaged during installation if grazed or knocked by tools. Please take care to protect the surfaces during installation.
- Protect the cooktop surface with cardboard, or similar, to prevent damage occurring whilst the rangehood is being installed above.
- Temporarily mark the height of the bottom of the rangehood and the centre of the cooktop on the wall according to the information given in the 'Installation Height' section.
- The wall used for mounting the rangehood should have sufficient strength and a flat surface.

PRODUCT DIMENSIONS

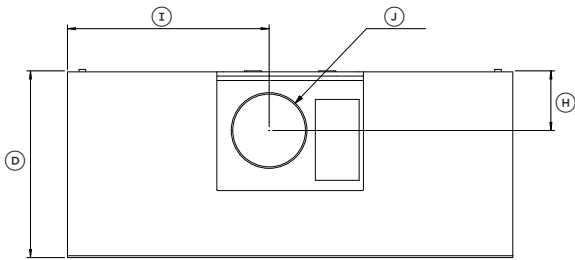

PLAN

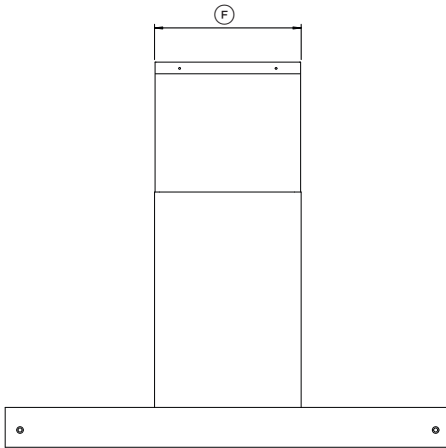

PROFILE

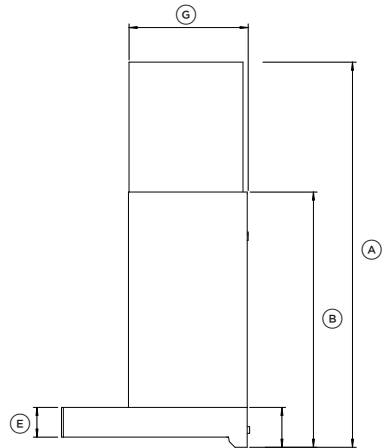

FRONT

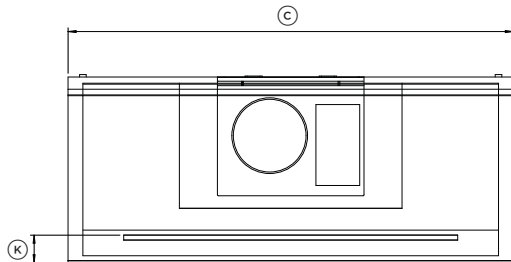

BOTTOM VIEW

PRODUCT DIMENSIONS

PRODUCT DIMENSIONS	HC120BCX2
	MM
Ⓐ Maximum overall height of product	1038
Ⓑ Minimum overall height of product	675
Ⓒ Overall width of product	1200
Ⓓ Overall depth of product*	500
Ⓔ Height of rangehood control panel	80
Ⓕ Width of chimney	395
Ⓖ Depth of chimney*	321
Ⓗ Distance from centre of ducting outlet to back of product*	161
Ⓘ Distance from centre of ducting outlet to side of product	544
Ⓙ Diameter of ducting outlet	204
Ⓚ Distance from light to front of product	65
Ⓛ Height from bottom of oil receptacle to top of control panel	110
Length of power cord	1000

*Including mounting bracket

Actual product dimensions may vary by ± 2 mm.

INSTALLATION HEIGHT

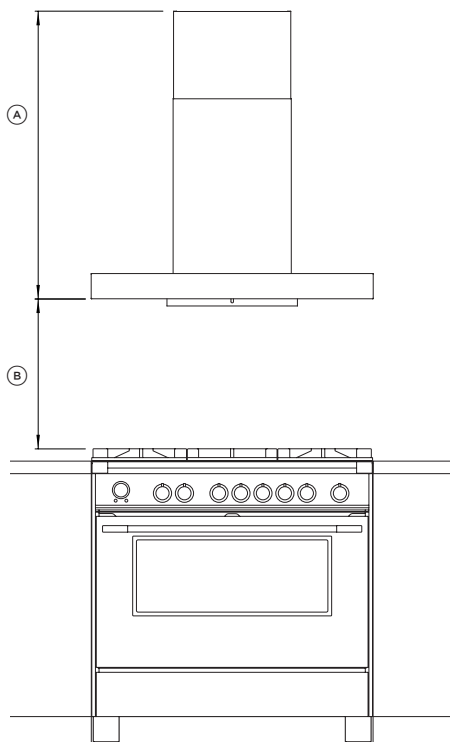

HEIGHT DIMENSIONS	MM
Ⓐ Ducted installation	
• Minimum height	635
• Maximum height	885
Ⓑ Height top of cooktop to base of product	
• Electric cooktop	min 650 - max 750
• Gas cooktop	min 650 - max 750

This rangehood must be installed no lower than the minimum height indicated in the table above. Minimum installation height may be greater if required by the cooktop, refer to your cooktop installation instructions.

Installation at the minimum height will improve the efficiency of capturing cooking odours, grease and smoke. Installation above the minimum height is the user's preference, it is not recommended to install above the maximum height indicated in the table above.

INSTALLATION HEIGHT

Induction cooktop considerations

- Induction cooktops use energy efficient technology that only heats the contents of a cooking pot.
- Unlike gas or traditional electric cooktops, the surrounding air does not get heated when using an induction cooktop. As a result, rangehood filters, splashbacks and surrounding cabinetry do not get warmed up, increasing the likelihood of condensation on these cooler surfaces.
- Other factors like ambient temperature, humidity, natural ventilation of the room, size of the cookware and how the induction cooktop is being used also influence condensation. For example, aggressive boiling on high cooktop heat settings like PowerBoost increases the rate at which water is evaporated, increasing the likelihood of condensation.
- It is important to understand that neither the rangehood nor the induction cooktop are faulty as a result of this phenomenon.

Condensation can be minimised by:

- Installing the rangehood at the maximum height above the cooktop as specified in this user guide.
- Using the rangehood on a lower speed setting when boiling.
- Using the induction cooktop on a lower heat setting when boiling.
- Switching the rangehood on 5 minutes before cooking and letting it run for at least 5 minutes after cooking. Refer to your user guide for details of how to use the timer function.

ELECTRICAL REQUIREMENTS

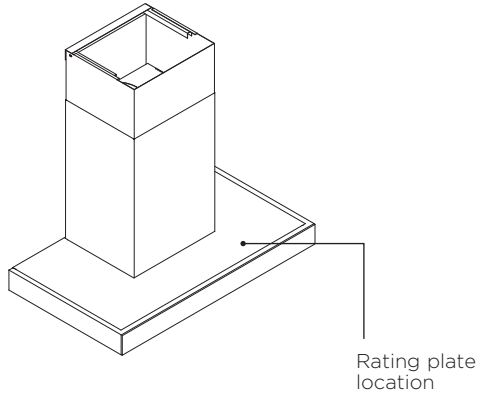

Before connecting the rangehood to the power supply, ensure the voltage and frequency indicated on the rating plate match that of the installation location:

MODEL	FREQUENCY	VOLTAGE
HC120BCX2	50 Hz	220 V

ATTACH BRACKETS AND MOUNTING SCREWS

Use the supplied mounting screws and expansion plugs if attaching to concrete or brick walls. Different fixings will be required for other types of wall construction.

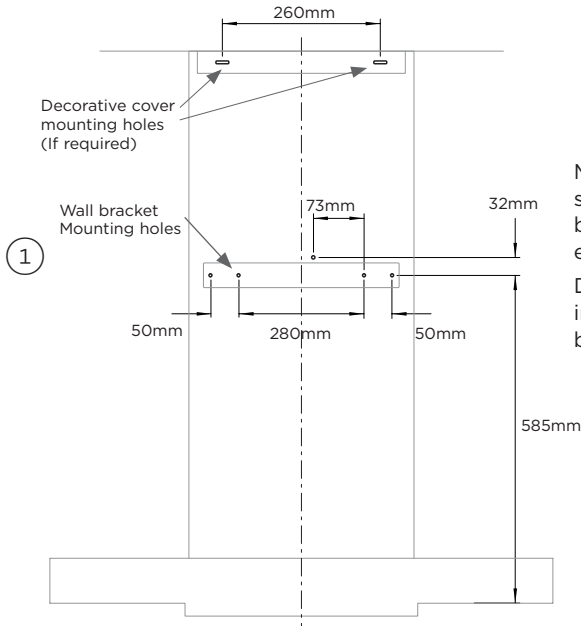

Mark the locations for the wall bracket, stopper screw and upper chimney bracket (if using the upper chimney extension).

Drill 55mm deep holes using an impact drill with a $\text{Ø}10$ mm masonry bit.

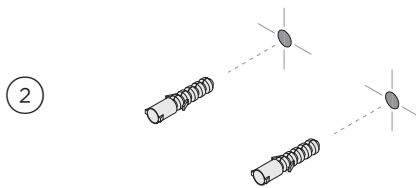

Fit the expansion plugs into the holes.

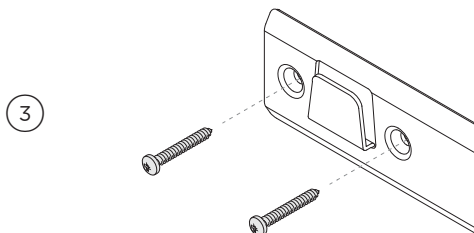

Attach the wall bracket and upper chimney bracket using the mounting screws.

HANG RANGEHOOD

The rangehood is heavy and requires two people to attach to the wall.

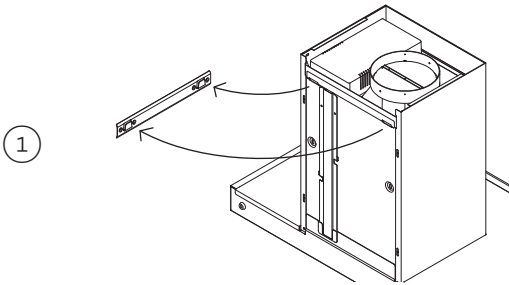

Attach the rangehood to the wall bracket.

Ensure the rangehood and wall bracket are firmly locked together.

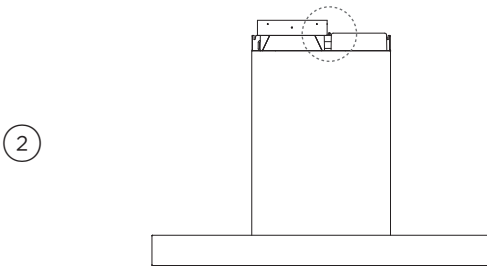

Insert the stopper screw at the top of the rangehood.

Ensure the screw is tightly secured against the rangehood.

CONNECT DUCTING

Ensure the ducting hose is stretched tight and trimmed to suit the installation space. For best performance, the ducting hose should not exceed 3m and should have minimal bends.

1

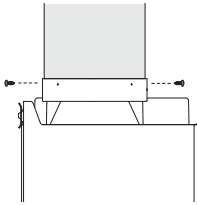

Insert the unmarked end of the ducting hose into the check valve.

Attach with the supplied valve adaptor.

2

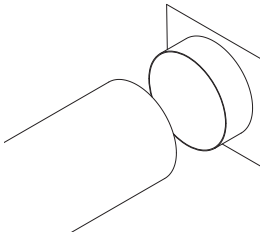

Connect the other end of ducting hose to a shared flue or external wall hole.

ATTACH ACCESSORIES

1

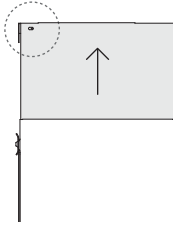

Extend the upper chimney extension (if using) and attach onto the upper chimney bracket.

2

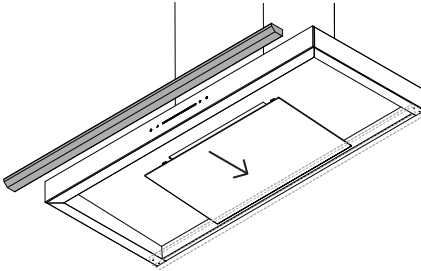

Fit the oil receptacle onto the rangehood. Position it between the tabs on the oil filter and push into place.

3

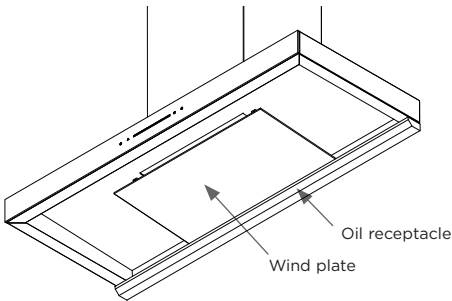

Install the oil receptacle and wind plate.

4

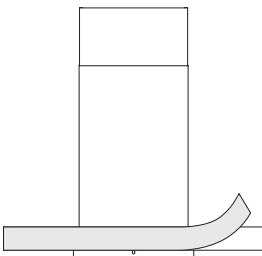

Remove all protective wrappings.

ABOUT YOUR RANGEHOOD

TECHNICAL DATA	
Light bulbs	10W
Type of power	Rated voltage: 220 V
	Rated frequency: 50 Hz
Motor input power	230 W
Rated input power	240 W
Maximum air flow	Maximum 20 m ³ /min
Air pressure	Maximum: 830 Pa Airflow 7m ³ /min:600Pa
Noise	70 dB (A)
Universal ducting hose	Outer diameter: 180 mm
	Length: 2000 mm
Net weight	37 kg
Odour removal efficiency	Nominal ≥ 95%
Grease separation	Nominal ≥ 85%
Off power	N/A
Standby power	≤ 2 W
Air flow efficiency	≥ 23
Energy efficiency rating	1st grade

FINAL CHECKLIST

TO BE COMPLETED BY THE INSTALLER

- Rangehood is correctly installed
- All connections are secure
- Connections have not pierced any electrical or water lines within the wall
- Ducting has not been crushed or bent in any areas
- Flexible ducting has been pulled taut and any excess removed (if required)
- Power plug switch is accessible to the customer
- Product is plugged in and power switched on
- Operation of the product has been tested

Complete and keep for safe reference:

Model _____

Serial no. _____

Purchase date _____

Purchaser _____

Dealer address _____

Installer's name _____

Installer's signature _____

Installation company _____

Installation date _____

[FISHERPAYKEL.COM](https://www.fisherpaykel.com)

© Fisher & Paykel Appliances 2023. All rights reserved.

The models shown in this guide may not be available in all markets and are subject to change at any time.

The product specifications in this guide apply to the specific products and models described at the date of issue. Under our policy of continuous product improvement, these specifications may change at any time.

For current details about model and specification availability in your country, please go to our website or contact your local Fisher & Paykel dealer.

431315A 05.23