

DES

PROFESSIONAL GRILL CART

CAD1 models

INSTALLATION GUIDE / USER GUIDE

NZ AU

CONTENTS

Safety and warnings	4
Introduction	6
Model identification & dimensions	7
Shipping inspection	8
Locating the cart	9
Cart assembly instructions	9
Components	10
Cart assembly instructions	11
Side shelf assembly instructions (optional)	18
Using the cart	19
Removing the drawers	19
Re-installing the drawers	19
Care and maintenance	21
Service & warranty	22

IMPORTANT! **SAVE THESE INSTRUCTIONS**

The models shown in this user guide may not be available in all markets and are subject to change at any time. For current details about model and specification availability in your country, visit our website listed on the back cover or contact your DCS dealer.

SAFETY AND WARNINGS

To reduce the risk of fire, electrical shock, injury to persons, or damage when using the appliance, follow the important safety instructions listed below: hazard or other injury.

WARNING!



Explosion Hazard

Failure to follow this advice may result in injury or death.

- Do not store or use gasoline or other flammable vapors and liquids inside or in the vicinity of this or any other appliance.
- An LPG cylinder not connected for use shall not be stored inside or in the vicinity of this unit.

WARNING!



Tip Hazard

Failure to follow this advice may result in injury.

- Do not push down on the top of the drawers. The unit could tip forward.
- Do not overload drawers. Maximum rating of each drawer is 15kg.

WARNING!



Crush Hazard

Failure to follow this advice may result in injury.

- Improper hand placement during drawer closure may cause injury to hands or fingers. Always close or open drawers using their handles.
- Be sure to keep hands away from drawer edges when opening or closing drawers.

SAFETY AND WARNINGS

- Do not allow children or pets to play in or around the cart.
- To prevent personal injury or damage to the drawers, do not overload them. The maximum rating of each drawer is 15kg.
- Do not store items of interest to children above or on the inside of any cart. Children could be seriously injured if they should climb onto or into the cart to reach these items.
- To prevent injury from tipping, all BE1 products must only be used with CAD1 model carts.

IF YOU SMELL GAS:

- Do not turn on any electrical switch; do not use any phone in your building.
- Immediately call your gas supplier from a neighbor's phone.
- Follow the gas supplier's instructions.
- If you cannot reach your gas supplier, call the fire department.
- Installation and service must be performed by a qualified installer, service agency or the gas supplier.

INTRODUCTION

Thank you for selecting this DCS Grill Cart. This installation and user guide contains valuable information on how to properly install, and maintain your new Professional Grill Cart for years of safe and enjoyable use.

For your convenience, product questions can be answered by a DCS Customer Care Representative at www.fisherpaykel.com, or email: customer.care@fisherpaykel.com.

MODEL IDENTIFICATION & DIMENSIONS

CAD1-48

Front

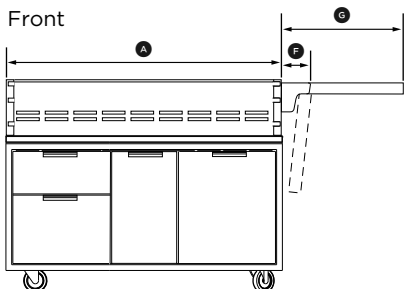

CAD1-36

Front

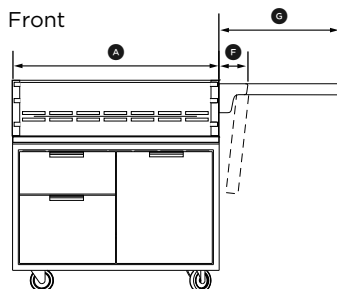

CAD1-36 and CAD1-48

Profile

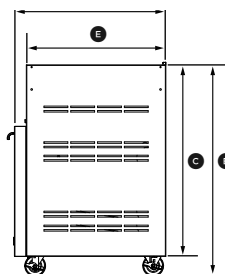

PRODUCT DIMENSIONS	CAD1-36	CAD1-48
	MM	MM
Ⓐ Overall width of cart	914	1219
Ⓑ Overall height of cart	902	902
Ⓒ Height of cart chasis (excluding wheels)	816	816
Ⓓ Overall depth of cart (excluding handles)	648	648
Ⓔ Depth of cart chasis (excluding doors & handles)	597	597
Ⓕ Width of side shelf bracket (optional)*	114	114
Ⓖ Width of side shelf (optional)*	610	610

*Can be fitted to either side of the cart.

INSTALLATION

Compatibility

IMPORTANT!

- All BE1 outdoor products must only be used with CAD1 cart models. They cannot be used with any other CAD carts.
- All BGB products can be used with both CAD and CAD1 cart models

Shipping inspection

IMPORTANT!

- Do not discard any packing material (box, straps) until the unit has been inspected.
- ① Inspect the Cart to verify that there is no shipping damage.
 - ② If any damage is detected, call the retail dealer and initiate a damage claim. DCS is not responsible for shipping damage.
- Operate the drawers to be sure they glide smoothly.
 - Examine the drawer fronts to be sure there are no dents or scratches.

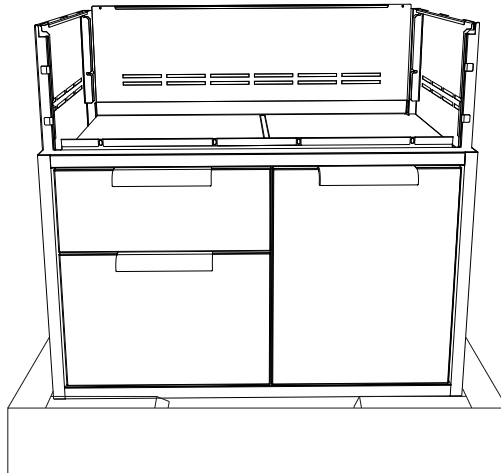

INSTALLATION

Locating the cart

For proper use, this product should be installed/positioned on a flat ground or patio. Unevenness such as bumps, cracks and protrusions should be 6mm or less. Refer to illustration and the below table for required flat area dimensions.

PRODUCT DIMENSIONS	CAD1-36	CAD1-48
	MM	MM
Ⓐ Overall width of cart	915	1220
Ⓑ Overall height of cart	1220	1220

Cart assembly instructions

IMPORTANT!

- Some parts have sharp edges; care must be taken when handling the various components to avoid injury. Please read safety information provided in these instructions before beginning assembly. Wear gloves when handling.
- Two or more people should work together to assemble the cart and grill.
- Avoid using side shelf to move cart. Push or pull the cart by grasping corners of grill head.

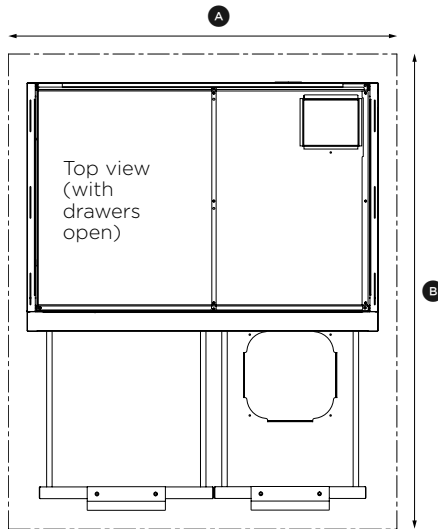





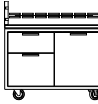

INSTALLATION

Components

Your cart is packaged in one box. The box contains your cart and a universal hardware kit to be used for grill installation and may contain extra hardware for your convenience.

Table of quantity of parts

CONTENTS	MODEL	PART NO.	QTY
	CAD1-36	82957	1
36" Cart shown	CAD1-48	82958	1
CONTENTS	CAD1-36	CAD1-48	
 Machined Phillip screws 10-24X1/2"	16	17	
 Bracket, Tab	2	4	
 Bolt Hex 1/4-20-12"	2	2	
 Washer .313 x .750	4	4	
 Nut Hex 1/4-20	2	2	

Tools required



Eye Goggles

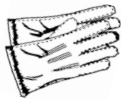

Work Gloves



Power Screwdriver or Variable Speed Drill with Phillips - tip #2 Attachment



Allen Wrench (3): 5/32", 3/16" and 3/32"

INSTALLATION

Cart assembly instructions

Linking carts together (optional)

To link two or more CAD1 carts, the following instructions must be done first, using the hardware provided, before installing the top modules.

IMPORTANT!

Once the carts are linked, they cannot be moved. Moving the carts once linked could damage the carts.

- ① Hand tighten two bolts, four washers, and two nuts on the front and back sides of the carts as shown.
- ② Carefully wrench tighten fasteners once carts are aligned with each other.

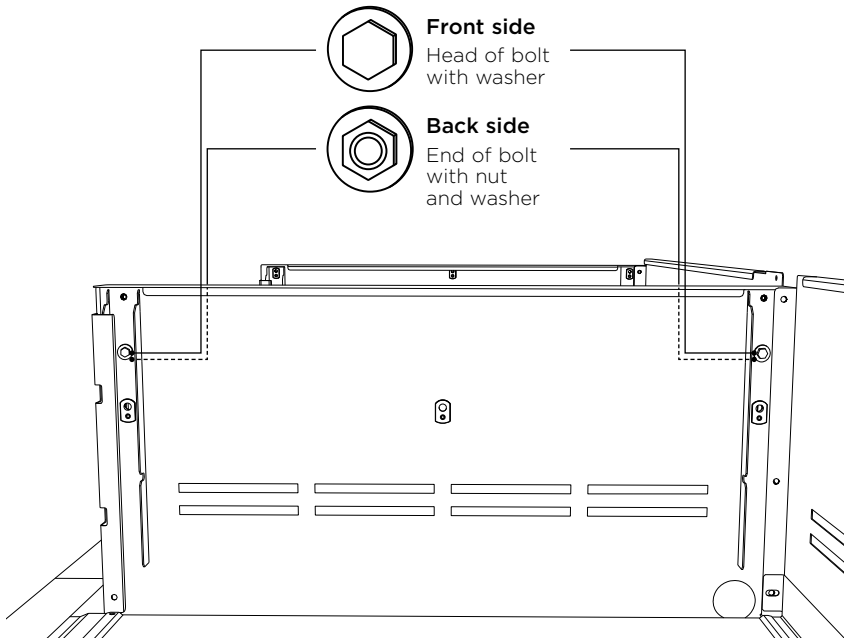

INSTALLATION

Outdoor appliance head preparation

IMPORTANT!

For the CAD1-48/48 there are two sets of brackets. If you have the BGB48-BQR, use the brackets labeled LEFT-48 BQR and RIGHT-48 BQR. If you have the BGB48-BQAR or BE1-48, use the brackets labeled 48-BQAR

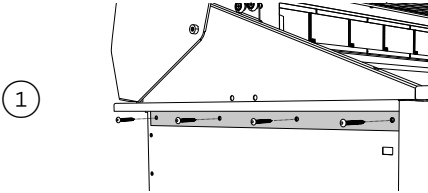

First you will need to remove the angle brackets from the side of the unit and replace them with cart mount brackets.

Note: grill is shipped prepared for island installation.

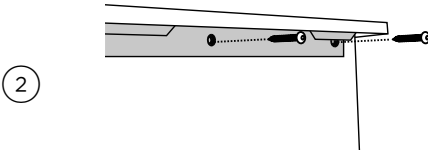

Install the bracket tab on both sides using eight of the 10-24 x 1/2" screws. Install each bracket with four screws on each side of the grill head. For a CAD1-48/48, use the appropriately labeled bracket for your grill head and cart side.

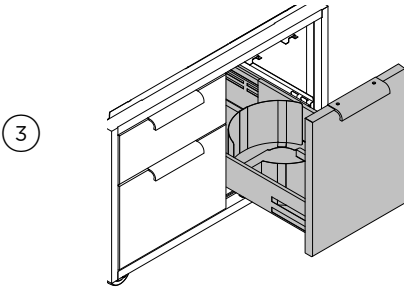

LPG models only:

Remove the gas compartment drawer for access to the gas hatch cover. Refer to page 19 for details.

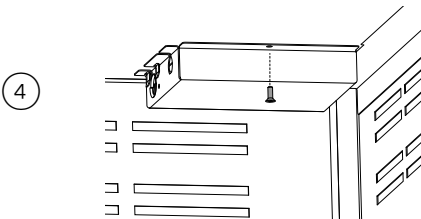

Using a Phillips screwdriver, remove the screw holding the hatch cover in place. Slide the hatch cover out.

INSTALLATION

Head placement onto cart

IMPORTANT!

- Be aware of pinch points and sharp edges to avoid injury to arms and hand.
- Two persons required to lift head.

1

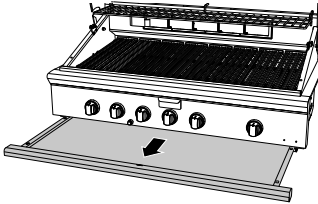

Remove drip tray/pan and other removable components such as grates, top burner caps and components, and radiant tray and grill burner for easier handling.

2

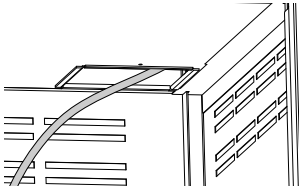

Ensure the gas hose is threaded through the rear hatch.

3

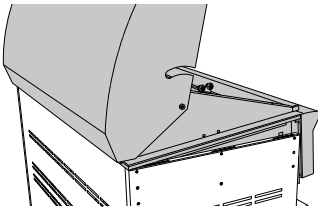

Placing head on cart, place rear of head over the rear of the cart first. Then allow the rear side tabs to first locate in the slots on the top of the cart sides. The other tabs will locate in the middle and front slots as the head is lowered into position on the cart.

4

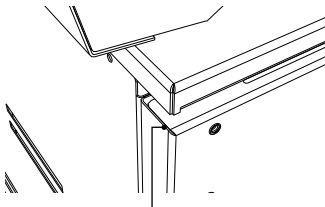

Pinch point

Position tabs on side bracket to fit into slots on the cart. When complete, the landing ledge should sit flush on the top of the cart.

5

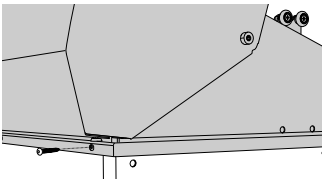

Secure the head to rear of cart with Phillips-head screws provided (10-24 x 1/2").

INSTALLATION

Front end screw installation

①

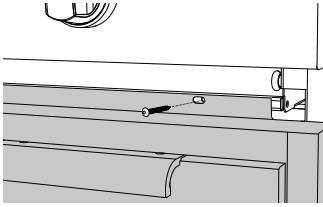

Install remaining screws (10-24 x 1/2") into the front of head to the cart.

②

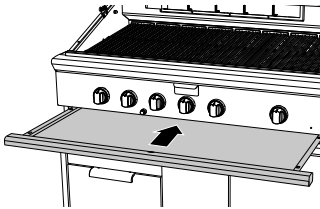

Slide drip tray/pan back into place.

INSTALLATION

Secure the gas hose and replace the gas compartment hatch cover

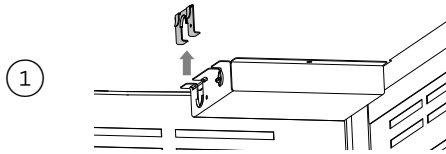

Undo the screw and remove the gas hose retainer from the hatch cover.

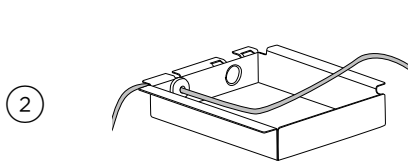

BE1 products only:

Remove plug from hatch cover and route electrical wiring through supplied strain relief bushing. Connect wiring to grill.

BH1 products only:

Ensure plug is secured to hatch cover.

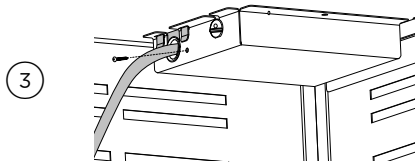

Slot the gas hose into the hatch cover cutout. Screw the retainer back in place. Ensure all the excess gas hose is pulled through into the gas compartment.

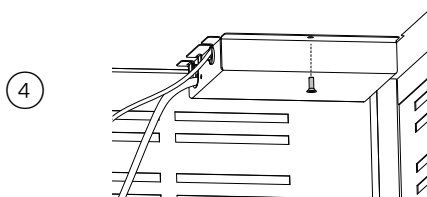

Secure the hatch cover into place.

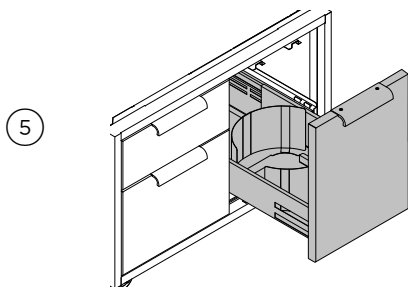

Replace the drawer. Refer to page 19.

INSTALLATION

Power Supply installation (for BE1 products only)

Your BE1 product comes supplied with a power supply for ignition and internal lighting, which is concealed in a box with an attached power supply cord. It is recommended that the power supply is mounted to the rear panel of the CAD1 cart using the 4 holes provided.

HZ	VOLTAGE	AMPS
50 Hz	230V	10A

IMPORTANT!

Use only a Residual Current Device (RCD) protected circuit with this power supply.

The suggested location for installation is above the hole the power supply cord routes through, which is on the inside of the right-hand side of the cart's back panel. Use four nuts and bolts to attach the power supply to the cart.

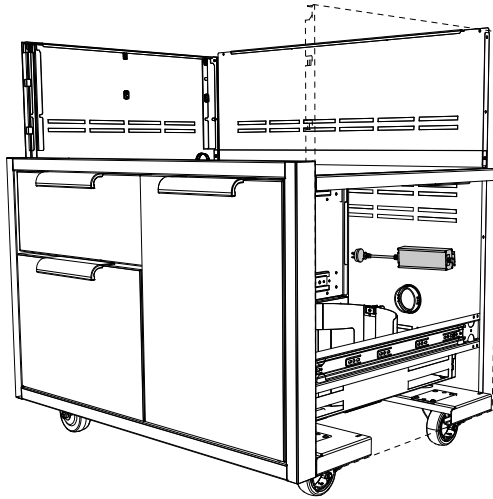

Routing the power supply cord

Route the cord through the provided hole and connect to the nearest 230V 10A RCD (Residual Current Device) protected electrical outlet.

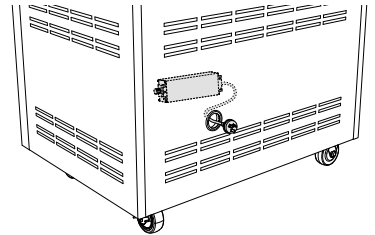

INSTALLATION

Gas hook-up - LPG

Place your 9kg cylinder (type 1) into the tank retention device as shown. Refer to your product user guide for detailed gas connection guidance.

IMPORTANT!

- To prevent personal injury or damage to the drawers, do not overload them. The maximum rating of each drawer is 15kg.
- Do not push down on the top of the drawers. The unit could tip forward.

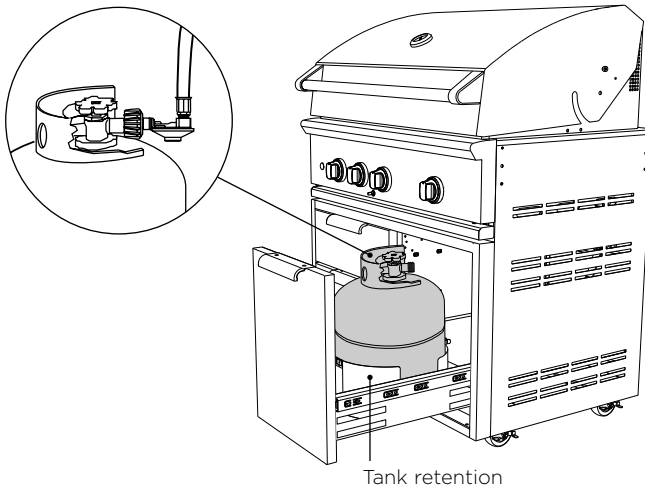

INSTALLATION

Side shelf assembly instructions (optional)

Optional attach side shelf accessory on either side

Note: side shelf model CAD1-SK can be installed with the head already on the cart.

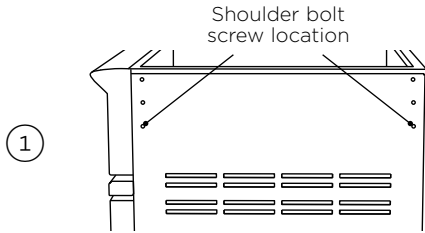

1 Screw two shoulder bolts into the bottom threaded holes on the side of the cart. Tighten with 5/32 Allen Key.

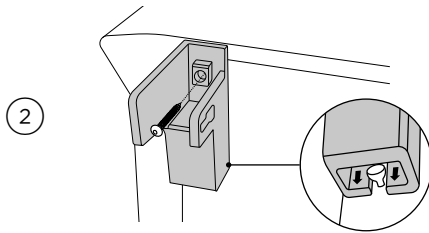

2 Slide shelf brackets over the shoulder bolts and install top screw, attaching the side-shelf brackets onto the cart. Tighten with Phillips screwdriver.

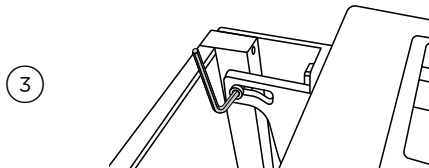

3 Holding the side shelf, install two shoulder bolts into the slot and screw into the side shelf tray. Tighten with a 3/16 Allen key.

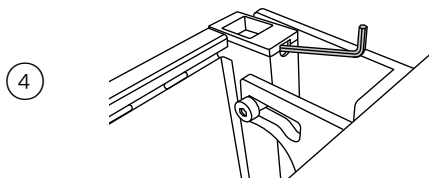

4 Place shelf in the up position and check for level. If shelf is not level, adjust side shelf set screw. Set screws can be adjusted using a 3/32 Allen Key. Turn the Allen key clockwise to raise the shelf. Turn 1/4 turn and review to see if the shelf is level. The set screws in the left and right bracket should be adjusted equally to ensure the shelf sits level.

Optional wood cutting board (model # CAD1-WCB, 70861) can be purchased as an accessory from www.fisherpaykel.com

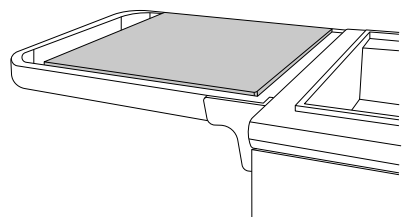

USING THE CART

Removing the drawers

IMPORTANT!

To prevent personal injury or damage to the drawers, do not overload them. The maximum rating of each drawer is 15kg.

To remove the drawers, pull them out until their slider latch is visible. Carefully push the latch down on the left side while pulling up on the latch on the right side and pull the drawer completely out of the frame.

To prevent damage to surfaces, place the drawers on a stable surface on a protective towel or tablecloth while removed from the cart.

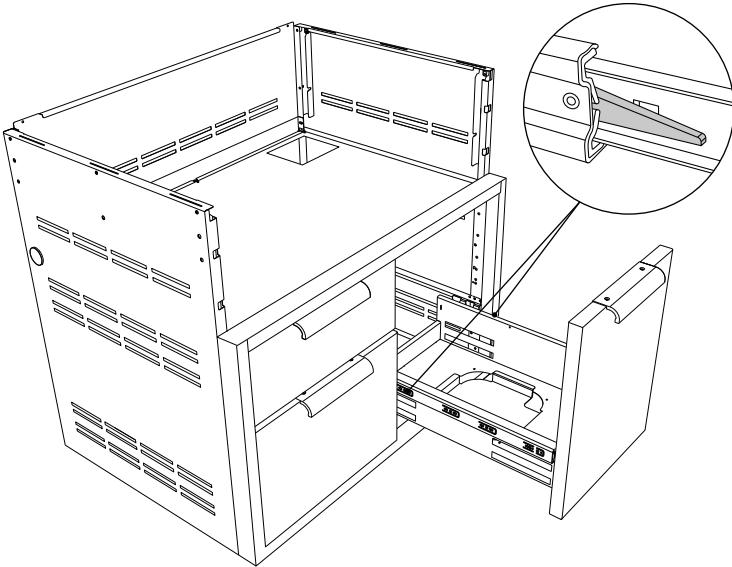

Re-installing the drawers

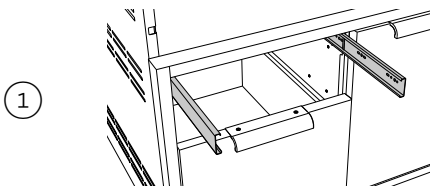

Re-install the drawers by extending their guides.

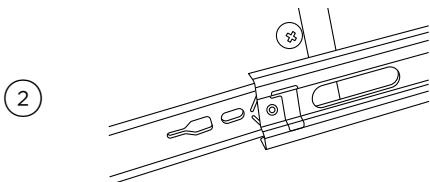

While holding the drawer parallel to the cabinet, carefully align & engage the ends of the glides. Slide the drawer about 25mm so that the glides are supporting the back of the drawer.

USING THE CART

3

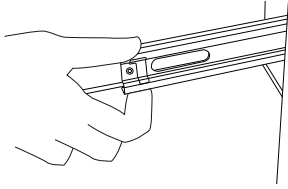

While holding the drawer up by the handle, pull the glides from the drawer cavity out over the drawer glide until they click.

4

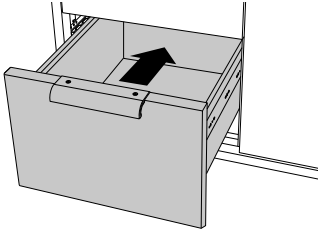

As you push the drawers in, you will encounter moderate resistance. Continue to push the drawer all the way in to complete the engagement process. The drawer will now glide smoothly in and out with light effort.

5

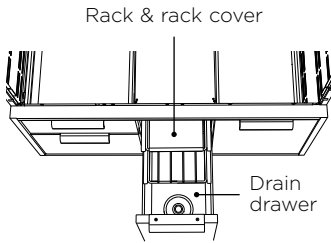

Install the two racks provided into the opening by sliding them onto the rollers on the sidewalls of the left cavity.

CARE AND MAINTENANCE

All parts of the Professional Grill Cart can be cleaned with hot soapy water, rinsed, dried and buffed to a shine with a soft, heavy cloth. Always try this first, as it is the mildest cleaning procedure.

- ① Use the mildest cleaning procedure first. Some brands of cleaners of the same type are harsher than others, read their directions. A scent or a propellant can make a difference in the product, read the ingredients. Try on a small area first.

Caution should be taken to keep the gas regulator free from any cleaning soaps or water.

- ② To avoid marring the surface, always rub metal finishes in the direction of the stainless steel polish lines (grain). The cleaner will be more effective when used in the direction of the polish lines.
- ③ Use only clean sponges, soft cloths, paper towels, plastic non-metal soap pads for cleaning or scouring as recommended in this section. (Use only soap pads with soap still in them. An empty pad can scratch.)
- ④ Be sure to rinse all parts thoroughly and to wipe dry to avoid water marks.
- ⑤ After cleaning, use a stainless steel polish, such as Stainless Steel Magic® applied to the drawer and handle surfaces.

Brand name cleaners

In this section on cleaning, the use of name brands is intended only to indicate a type of cleaner. This does not constitute an endorsement. The omission of any name brand cleaner does not imply its adequacy or inadequacy. Many products are regional in distribution and can be found in local markets and department stores.

SERVICE & WARRANTY

For warranty service, please contact your local service provider or DCS Customer Care Representative at www.fisherpaykel.com, please have the following information ready:

- Model number (can be found on the inside, left wall of the tank drawer).
- Serial number (can be found on the inside, left wall of the tank drawer).
- Code (can be found on the inside, left wall of the tank drawer).
- Date of installation.
- A brief description of the problem.

Your satisfaction is of the utmost importance to us. If a problem cannot be resolved to your satisfaction, please write or email us at:

Write to us

New Zealand

Fisher & Paykel Appliances Limited
PO Box 58546
Botany, Auckland 2163
Fax: (09) 273 0656
Email: customer.care@fp.co.nz

Australia

Fisher & Paykel Customer Services Pty
PO Box 798,
Cleveland,
QLD 4163
Fax: + 61 7 3826 9298
Email: customer.care@fp.com.au

Complete and keep for safe reference:

Model _____
Serial No. _____
Purchase Date _____
Purchaser _____
Dealer _____
Suburb _____
Town _____
Country _____

FISHERPAYKEL.COM

© Fisher & Paykel Appliances 2022. All rights reserved.

The models shown in this guide may not be available in all markets
and are subject to change at any time.

The product specifications in this guide apply to the specific products and models
described at the date of issue. Under our policy of continuous product improvement,
these specifications may change at any time.

For current details about model and specification availability in your country, please go
to our website or contact your local Fisher & Paykel dealer.

431013A 09.22