

FISHER & PAYKEL

BUILT-IN OVEN

OB30SP and OB30DP
touchscreen models

USER GUIDE

US CA

CONTENTS

Introduction	3
Safety and warnings	4
Before you start	8
First use	9
Using the oven light	17
Using the kitchen timer	18
Changing the time	20
Locking the control panel	21
Unlocking the control panel	22
Cooking options	23
Delayed cook	24
Auto off	25
Food probe	26
Guided cooking	29
Cooking guide	31
Cooking charts	37
User preference settings	43
Wifi connection and remote mode	45
Sabbath Mode	47
Care and cleaning	49
Using self clean	56
Troubleshooting	59
Alert codes	62
Warranty and service	63

INTRODUCTION

We hope you're excited to start cooking with your new Fisher & Paykel built-in oven. It's loaded with our latest cooking technology to ensure you perfect results for every dish, with a number of features designed for your safety and convenience.

COOK WITH CONFIDENCE Our touchscreen interface provides an intuitive guided cooking experience that helps deliver perfect results, whether you've been cooking all your life or just starting out. Cook with a favorite method, a hero ingredient, or a go-to cooking function or recipe.

DESIGN FREEDOM Designed to fit seamlessly into your kitchen, this built-in oven features premium materials and elegant styling to support a cohesive, considered kitchen design.

EXCEPTIONAL PERFORMANCE AeroTech circulates heat evenly for a consistent temperature throughout the cavity, helping you ensure perfect results even when cooking on multiple shelves.

SELF-CLEANING Our self-clean technology breaks down food residue at a very high temperature, leaving a light ash that's easily removed with a damp cloth. The enamel coated side racks don't need to be removed when using this function.

Register your product online. It'll help us give you the best service possible, and we'll also let you know when we have special offers or promotions running. Go to fisherpaykel.com/register now.

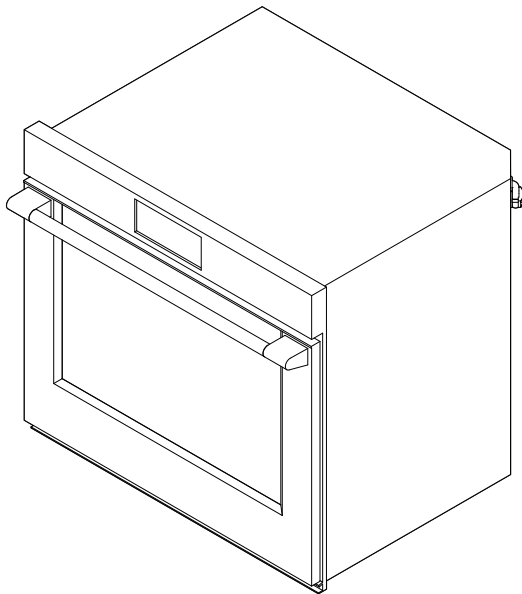

⚠ WARNING!



Electric Shock Hazard

Failure to follow this advice may result in electric shock or death.

- Turn the oven off at the wall before replacing the oven lamp.

⚠ WARNING!



Fire Hazard

Failure to follow this advice may result in overheating, burning, and injury.

- Carefully follow the instructions for starting a self-clean cycle.
- Do not place combustible materials (for example: wood, fabric, plastic) in the oven during a self-clean cycle.
- Do not place aluminium foil, dishes, trays, water or ice on the oven floor during cooking, this will irreversibly damage the enamel. Lining the oven with aluminium foil may cause fire.
- Never use your appliance for warming or heating the room. Persons could be burned or injured or a fire could start.
- Flammable materials should not be stored in an oven or near its surface.

⚠ WARNING!



Cut Hazard

Failure to use caution could result in injury.

- Take care: some edges are sharp.

⚠ WARNING!

Hot Surface Hazard

Failure to follow this advice could result in burns and scalds.



- To avoid burns and scalds, keep children away from this appliance.
- Surfaces of the appliance may become hot enough to cause burns. Examples include the oven vent, the surface near the oven vent, and the oven door.
- Do not touch heating elements or interior surfaces of the oven. Heating elements may be hot, even when they are dark in colour.
- Use protection when handling hot surfaces, such as oven shelves or dishes.
- Be careful when opening the oven door. Let hot air or steam escape before removing or replacing food.
- During and after use, do not touch or let clothing or other flammable materials contact heating elements or interior surfaces of the oven until they have had sufficient time to cool.

SAFETY AND WARNINGS

WARNING!

To reduce the risk of fire, electrical shock, injury to persons or damage when using the oven, follow the important safety instructions listed below. Read all the instructions before using the oven. Use the oven only for its intended purpose as described in these instructions.

Installation

- Ensure your appliance is properly installed and earthed by a qualified technician.
- Ensure this oven is connected to a circuit which incorporates an isolating switch providing full disconnection from the power supply.
- Do not install or operate the appliance if it is damaged or not working properly. If you receive a damaged product, contact your dealer or installer immediately.

Servicing

- Do not repair or replace any part of the appliance unless specifically recommended in the user guide. All other servicing should be undertaken by a Fisher & Paykel trained and supported service technician or qualified person.

Fire Hazard

- Do not use water on grease fires. Smother the fire or flame or use a dry chemical or foam type extinguisher.
- Use only dry oven mitts or potholders. Moist or damp potholders on hot surfaces could result in burns from steam. Do not let potholders touch hot areas or heating elements. Do not use a towel or a bulky cloth for a potholder. It could catch fire.
- Do not heat unopened food containers. They can build up pressure that may cause the container to burst and result in injury.

Food Safety

- Leave food in the oven for as short a time as possible before and after cooking. This is to avoid contamination by organisms which may cause food poisoning. Take particular care during warm weather.

General Use

- Household appliances are not intended to be played with by children.
- Children should not be left alone or unattended in the area where the appliance is in use. They should never be allowed to sit or stand on any part of the appliance.
- Children of less than 8 years old must be kept away from the appliance unless continuously supervised.
- This appliance can be used by children aged from 8 years and above, and persons with reduced physical, sensory or mental capabilities or lack of experience and knowledge, if they have been given supervision or instruction concerning the use of the appliance in a safe way and they understand the hazards involved. Cleaning and user maintenance shall not be carried out by children without supervision.
- Do not store things children might want above the oven. Children could be burned or injured while climbing on the oven to retrieve items.
- Do not place heavy objects on the oven door.
- Always keep oven vents unobstructed.

SAFETY AND WARNINGS

- Do not wear loose fitting or hanging garments when using the appliance. They could ignite or melt if they touch an element or hot surface and you could be burned.
- Do not change or modify the wireless communication device in any way. Changes or modifications not expressly approved by Fisher & Paykel could void the user's authority to operate the equipment.
- This device complies with Industry Canada's licence-exempt RSSs. Operation is subject to the following two conditions:
 - ① This device may not cause interference; and
 - ② This device must accept any interference, including interference that may cause undesired operation of the device.
- This device complies with part 15 of the FCC Rules. Operation is subject to the following two conditions:
 - ① This device may not cause harmful interference, and
 - ② this device must accept any interference received, including interference that may cause undesired operation.
- Caution: Hot air can blow from the vent at the top of the oven as part of the oven's cooling system.
- Always position shelves in the desired location while the oven is cool (before preheating). If a shelf must be removed while the oven is hot, do not let the oven mitts or potholder contact hot heating elements in the oven or the base of the oven.
- Use only bakeware approved for oven use. Follow the bakeware manufacturer's instructions.

Cleaning

- Do not clean the oven seal or use any oven-cleaning products on it. It is essential for a good seal, which ensures that the oven operates efficiently. Care should be taken not to rub, damage or move the oven seal.
- Do not use oven cleaners, harsh/abrasive cleaning agents, waxes, or polishes. No commercial oven cleaner, oven liner, or protective coating of any kind should be used in or around any part of the oven.
- Do not use harsh/abrasive cleaners, scourers or sharp metal scrapers to clean the oven door glass since they scratch the surface, which may result in the glass shattering.
- Clean only the parts listed in this manual.
- Do not use a steam cleaner to clean any part of the oven.

Self Cleaning

- Spillages must be removed before starting a Self Clean cycle.
- Before starting a Self Clean cycle, remove oven shelves, side racks, and all other cookware/utensils, and wipe up large food spills or grease deposits.
- Before starting a Self Clean cycle, ensure you move any pet birds to another, closed and well ventilated room. Some pet birds are extremely sensitive to the fumes given off during a Self Clean cycle and may die if left in the same room as the oven during such a cycle.
- During a Self Clean cycle, the oven reaches higher temperatures than it does for cooking. Under such conditions, the surfaces may get hotter than usual and children should be kept away.

BEFORE YOU START

- Ensure the installer has completed the Final checklist in the Installation instructions.
- Read this guide, taking special note of the 'Safety and warnings' section.
- Remove all internal and external packaging and dispose of it responsibly. Recycle items that you can.
- Refit the shelves to your desired position in the oven.
- Condition the oven, using the instructions under 'First use'.

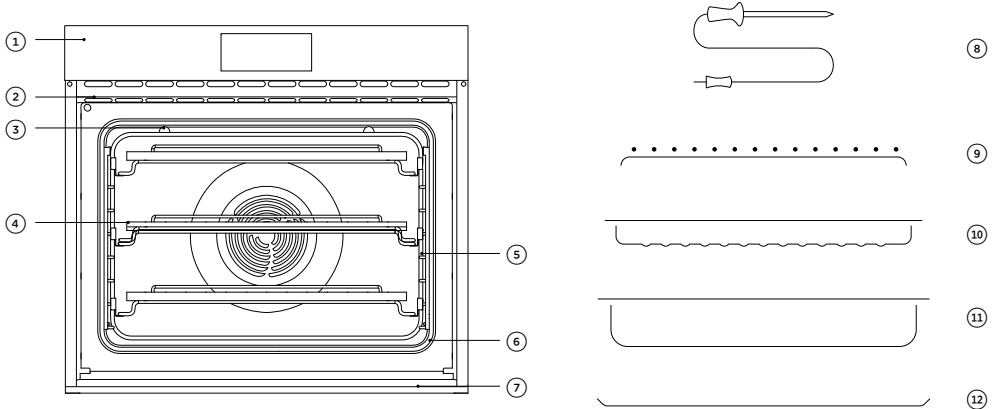

Oven features and accessories

- | | |
|---------------------------------|--------------------|
| ① Control panel | ⑦ Drip channel |
| ② Oven vent louvres | ⑧ Food probe |
| ③ Oven light location | ⑨ Broil rack |
| ④ Full extension sliding shelf* | ⑩ Grid |
| ⑤ Side rack | ⑪ Broil pan |
| ⑥ Oven seal | ⑫ Flat baking tray |

*Single models: x3; Double models: x5

Not all accessories are provided with all models. To purchase other accessories, contact your nearest Fisher & Paykel Service Centre, Customer Care or visit our local website listed on the back cover.

FIRST USE

Oven racks

Your oven comes with the shelves positioned and secured inside. The following shows you how to remove and reposition them to your preferred position.

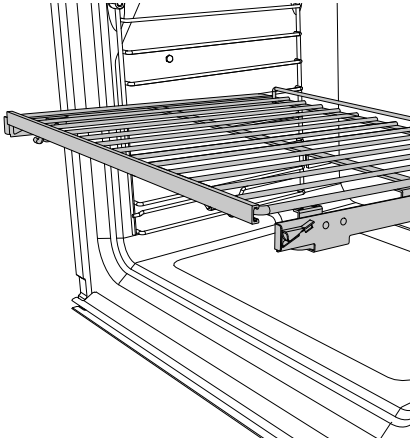

Remove shelves from the oven

- ① Remove all cable ties and packaging holding the shelves in place.
- ② Remove all the shelves and accessories, taking special care with the sliding shelves.
- ③ To remove a sliding shelf, grip it at the front (making sure you are gripping the wire shelf and the sliding frame together), lift upwards and pull it out of the oven.

For your safety, the sliding frames are built together as one unit and are not separable. When placed properly on the side racks, the slides will prevent the wire shelves from tilting when pulled towards you.

FIRST USE

Replace shelving in your preferred positions

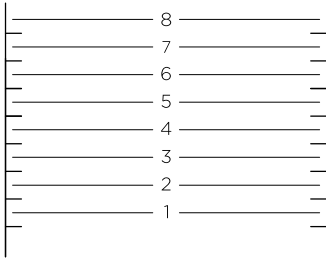

Shelf positions

We recommend placing the sliding shelves on position 3 and 6 for everyday cooking.

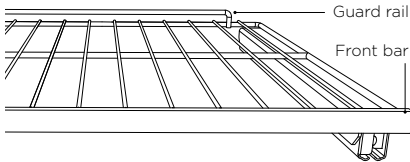

To replace shelves

- ① Grip the shelf at the front (making sure you are holding the wire shelf and the sliding frame together).
- ② Ensure the shelf is level and facing the right way with the guard rail at the back.
- ③ Place the shelf on top of the side racks at the desired height, hooking the rear tags over the side racks on both side.
- ④ Push the shelf all the way into the oven, making sure the front tags are also securely hooked over the side racks.

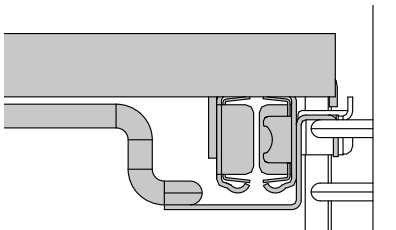

Ensure shelves are positioned on top of the side rack wires instead of between them.

When there is food in the oven, take care to slide the shelves horizontally when extending them. This will prevent the tags lifting off the side racks and the shelf tipping over.

FIRST USE

Control panel

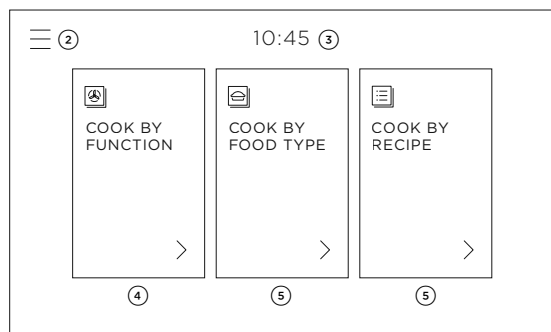
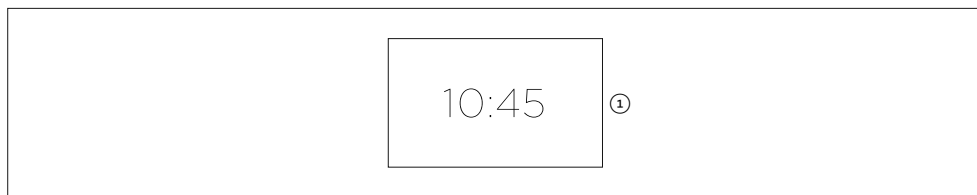

Control panel features

- ① Touch screen display
- ② Menu
- ③ Clock
- ④ Oven functions
- ⑤ Guided cooking features

Touch screen display

Your oven is operated using an intuitive touch screen display. Use the screen to navigate cooking functions, guided cooking features and settings.

Using the touch controls

Use the ball of your finger, not its tip. The controls respond to touch, so pressure is not needed.

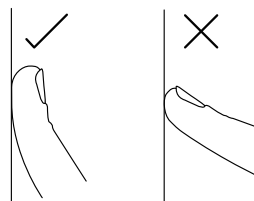

FIRST USE

Setting the clock

You'll need to set the time on your oven when it is first turned on, or after a power cut.

1

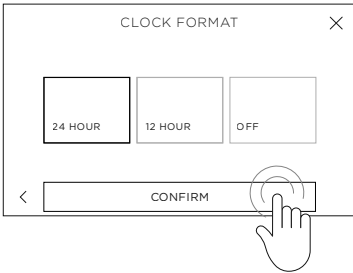

Set the clock format. Choose between **24 HOUR**, **12 HOUR** or **OFF** then select **CONFIRM**.

2

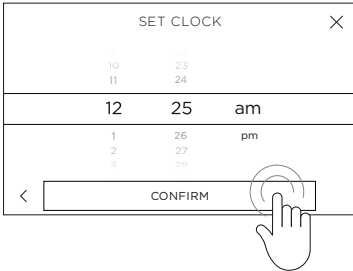

Scroll to set the correct time then select **CONFIRM**.

3

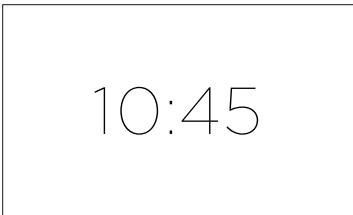

The time is now set and will show on the screen.

FIRST USE

Function menu layout

To select and use a function, touch the function name or icon. For more information on each function, touch the description underneath each function name.

Select function

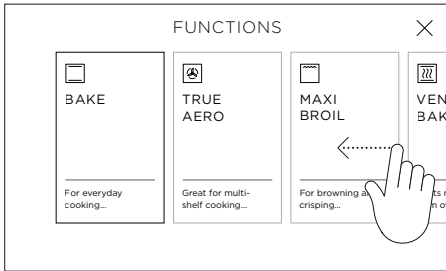

Expand description

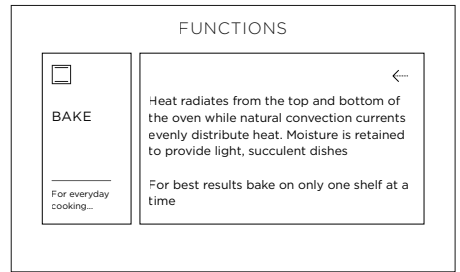
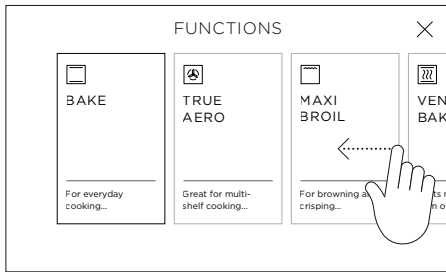

Double models

Before selecting a function, choose which oven you want to cook in.

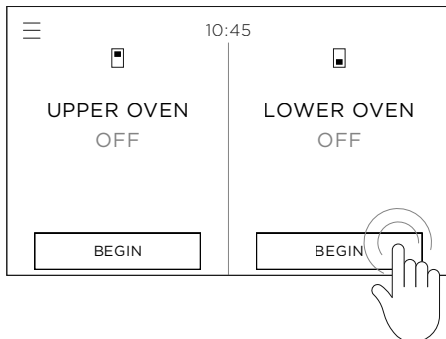

FIRST USE

Setting a function and temperature

For more information on the functions, touch the description underneath each function name or see the 'Cooking guide' section of this book.



Touch the screen or turn the dial* to enter the menu. Select **COOK BY FUNCTION**.

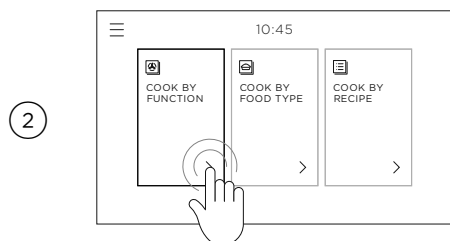

Scroll through the functions and select the one you want to cook with.



To adjust the preset temperature, swipe left or right or use the dial. Touch **START** to heat the oven and begin cooking.

A red bar will show on the screen while the oven is heating.

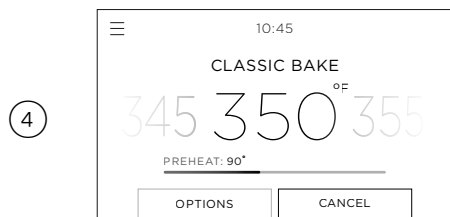

When the oven has reached the set temperature, a tone will sound, the bar will disappear and the dial* will turn white.

Some functions do not need to preheat. For those functions the bar won't show.

FIRST USE

Editing or cancelling cooking

Touch the function name or temperature at any point during cooking to adjust.

Changing the temperature

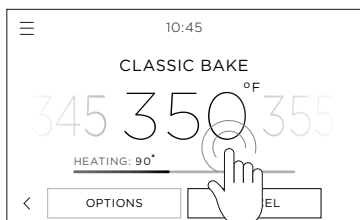

Changing the function

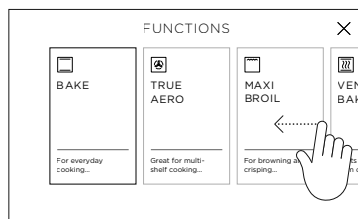
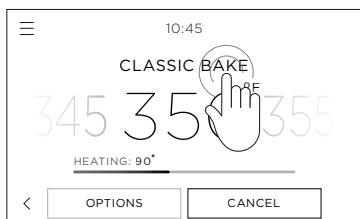

Turning the oven off

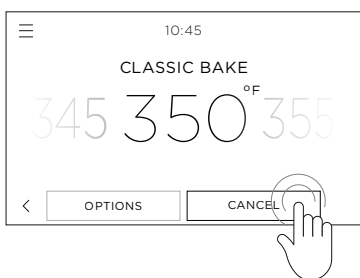

To stop cooking and turn the oven off, press **CANCEL** and then **CONFIRM** at any point.

Rapid preheating stage

For some cooking functions, the oven will go through an initial rapid preheat stage. In this stage, the fan and both bake and broil elements will turn on to quickly heat the oven to the set temperature. Depending on the cooking function, the fan, bake and broil elements will turn off once the oven reaches the set temperature.

FIRST USE

Conditioning the oven

It is important to condition your oven before using it for cooking. This will burn off any manufacturing residues and ensure that you get the best results right from the start. It will take approximately 1 hour.

Before you start:

Make sure you have removed all packaging and any cable ties used to secure the shelving during transit. Make sure all shelves are fitted in the oven. Make sure the kitchen is well ventilated during conditioning.

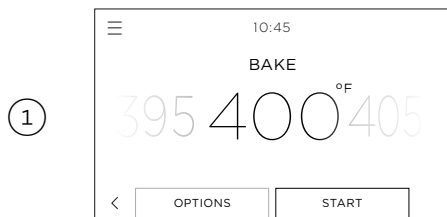

Select **COOK BY FUNCTION** and set the oven to **BAKE** at 400°F (200°C) and heat for 30 minutes.



After 30 minutes change the function to **AERO BROIL** and heat for 5 minutes.



After 5 minutes, change the function to **TRUE AERO** and heat for a further 20 minutes. When you have finished, turn the oven off.

After conditioning:

There will be a distinctive smell and a small amount of smoke during the conditioning process as manufacturing residue is burnt off. This is normal, but make sure the kitchen is well ventilated. Once cooled, wipe out the oven with a damp cloth and mild detergent, and dry thoroughly.

USING THE OVEN LIGHT

Turning the oven light ON or OFF

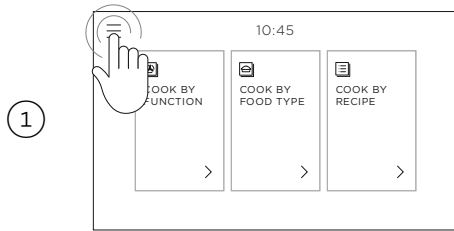

Touch the menu icon in the top left corner of the display.

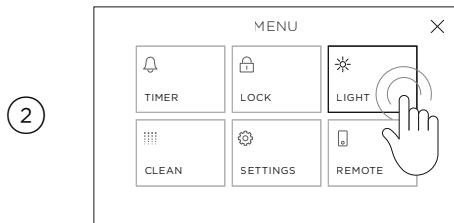

Select **LIGHT**.

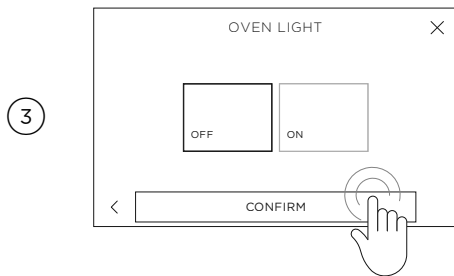

Select **ON** or **OFF** as required and then select **CONFIRM**.

USING THE KITCHEN TIMER

- Use the kitchen timer to keep track of cooking times. You can use it at any time, even if you are not using the oven.
- The kitchen timer does not turn the oven off. See 'Cooking options' for how to set the **AUTO OFF** timer or **DELAYED COOK**.

Setting the timer

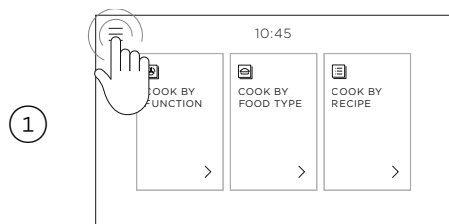

Touch the menu icon in the top left corner of the screen.

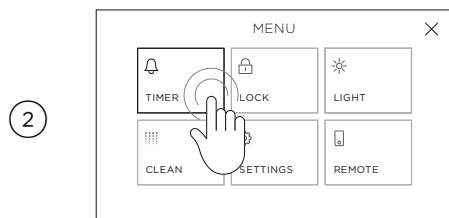

Select **TIMER**.

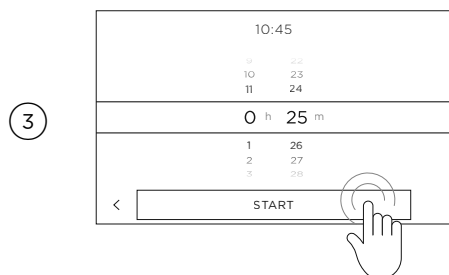

Scroll to set timer length then select **START**. You can set the timer for up to 11 hours 59 minutes.

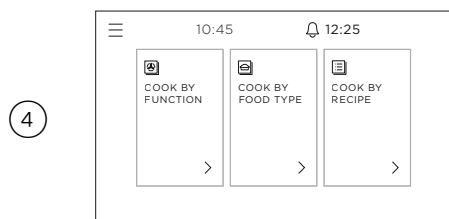

The timer countdown will show on the screen.

USING THE KITCHEN TIMER

Editing or cancelling the timer

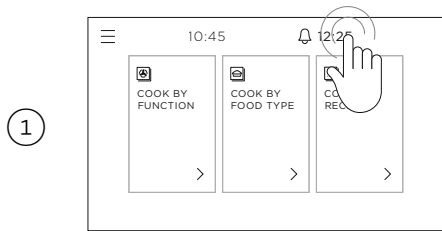

Touch the timer countdown in the upper right of the screen.

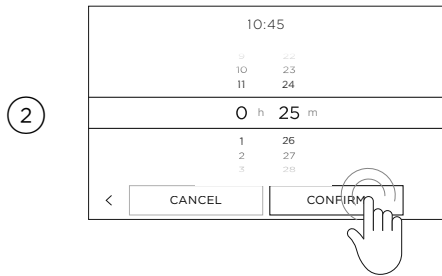

Adjust the timer as needed and select **CONFIRM**, or touch **CANCEL** to cancel the timer completely.

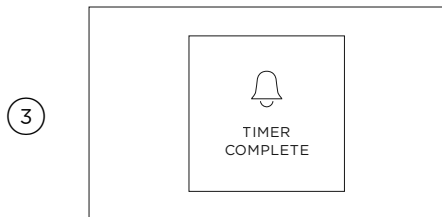

At the end of the timer a tone will sound every few seconds. Touch the screen anywhere to stop it.

CHANGING THE TIME

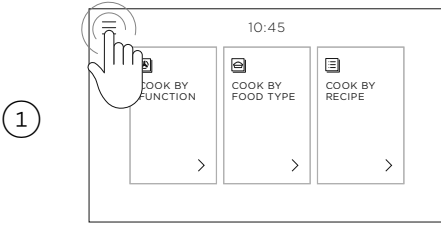

Touch the menu icon in the top left corner.

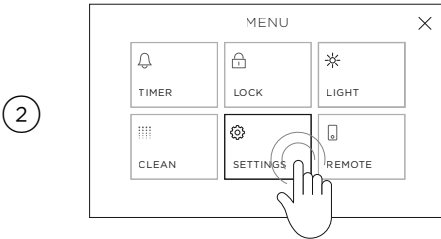

Select **SETTINGS**.

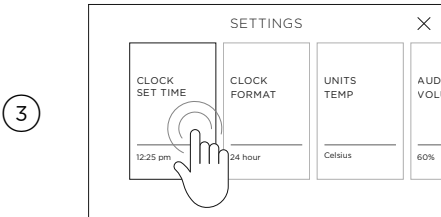

Select **CLOCK SET TIME**.

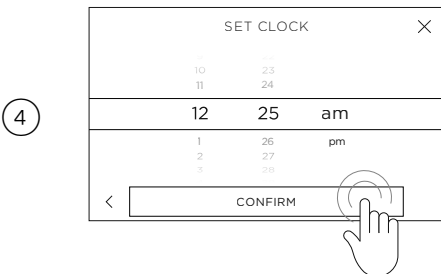

Scroll to change the time then select **CONFIRM**.

LOCKING THE CONTROL PANEL

Lock the oven controls to prevent accidental use of the oven by children or when cleaning. When locked, the controls are unresponsive and the oven will not turn on.

For safety reasons you cannot lock the oven controls while the oven is in use or if automatic cooking options have been set.

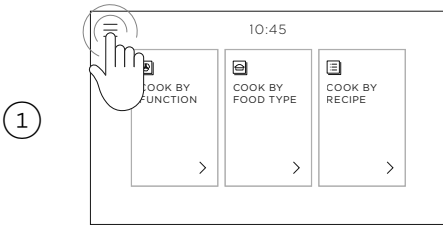

Touch the menu icon in the top left corner of the screen.

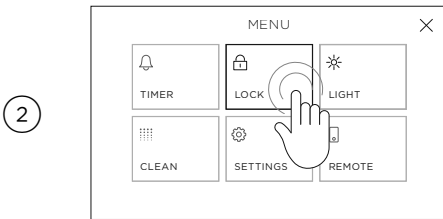

Select **LOCK**.

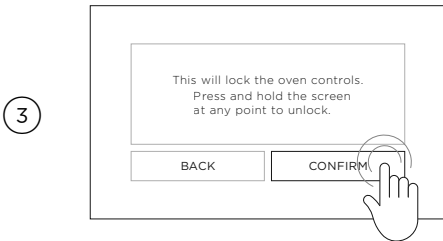

Select **CONFIRM**.

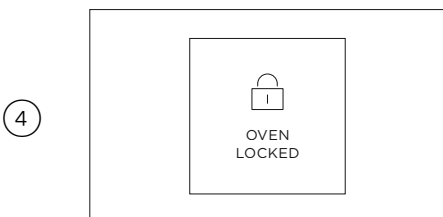

The control panel is now locked. The controls will remain unresponsive until it is unlocked.

UNLOCKING THE CONTROL PANEL

1

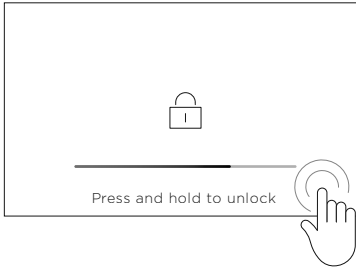

Press and hold anywhere on the screen until the bar fills and the oven unlocks.

COOKING OPTIONS

Your oven comes with a number of automatic cooking options to help you get the best results:



DELAYED COOK

Set the oven to turn on later in the day, cook for a set length of time and turn off automatically.



AUTO OFF

Set the oven to turn off after a set length of time.



FOOD PROBE

Use the food probe to automatically turn your oven off when your food reaches a set internal temperature.

You can set these options either before you start cooking, or at any point once your oven is already running.

1

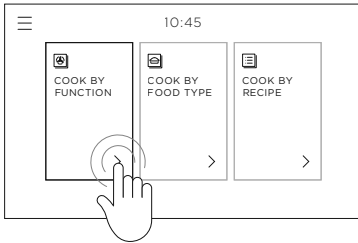

Select **COOK BY FUNCTION**.

2

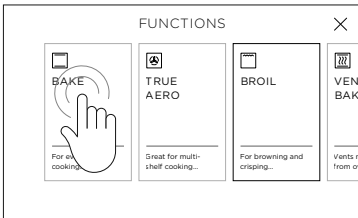

Select the function you want to cook with.

3

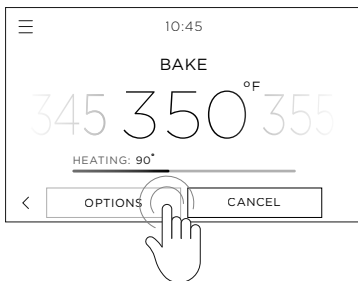

Touch **OPTIONS** at the bottom of the screen and select the option you want to use.

DELAYED COOK

Safe food handling: leave food in the oven for as short a time as possible before and after cooking or defrosting, to avoid contamination by organisms which may cause food poisoning. Take particular care during warmer weather.

When using **DELAYED COOK** we do not recommend using **MAXI BROIL**, **BROIL**, **AERO BROIL** or **AIR FRY** functions.

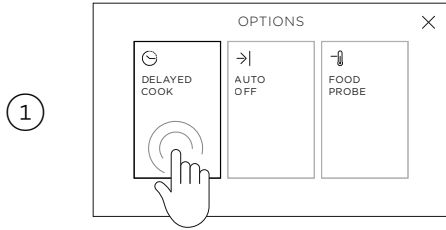

Select **DELAYED COOK** from the **OPTIONS** menu.

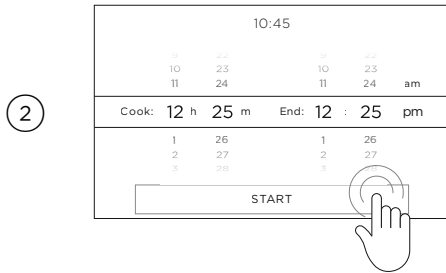

Scroll to set a cook duration and an end time, then select **START**.



DELAYED COOK is now set.

Your oven will automatically calculate when it needs to turn on based on what cook duration is set.

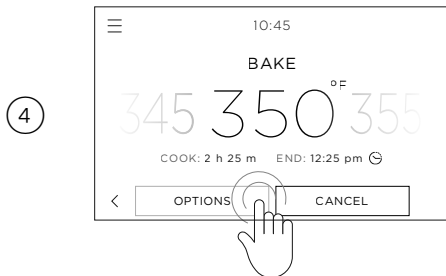

To edit or cancel

Touch **OPTIONS** and select **DELAYED COOK** at any point to edit or cancel.

When the end time is reached

The oven will automatically turn off and a tone will sound.

AUTO OFF

1

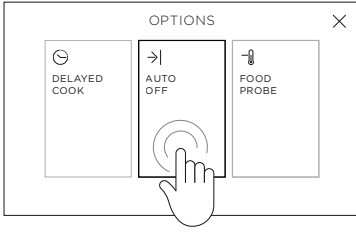

Select **AUTO OFF** from the **OPTIONS** menu.

2

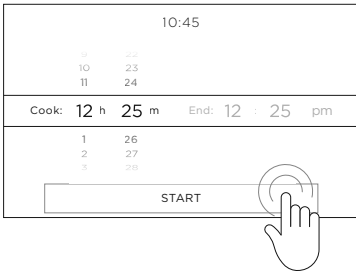

Scroll to set a cook duration and select **START**.

Your oven will automatically calculate the end time based on what cook duration is set.

3



AUTO OFF is now set.

Your oven will cook for the set length of time and then turn off automatically.

4



To edit or cancel

Touch **OPTIONS** and select **AUTO OFF** at any point to edit or cancel.

When the end time is reached

The oven will automatically turn off and a tone will sound.

FOOD PROBE

Tips for using the food probe

- You can still use the kitchen timer when the probe is in use.
- You cannot use the meat probe with **DELAYED COOK** or **AUTO OFF**.
- The internal temperature of meat will continue to rise by a few degrees after you have removed it from the oven, so allow for this in your calculations. After cooking, cover and let the meat rest for 15 to 20 minutes.
- If you wish to remove food from the oven (eg basting), unplug the meat probe from the oven but do not remove it from the meat. When you are ready to resume cooking, ensure you plug the probe plug back into the oven.
- When cooking meat, insert the probe horizontally into the centre of the thickest part. The thicker the meat, the longer it will take to cook, so it is important that the tip of the probe is measuring the temperature of the meat at its thickest point. Make sure the tip of the probe is not protruding out of the meat, and does not touch bone, fat or gristle, as these will heat up more quickly than the lean meat.

Internal temperatures and food safety

- Ensure meat is fully defrosted before cooking. The temperatures given onscreen and in the Cooking Guides are recommendations. Results will depend on the quality and composition of the food.
- Rest meat after cooking to allow the internal temperature to continue to rise.
- For food safety, high risk foods such as fish should reach a minimum internal temperature of 145 - 160°F (63 - 70°C) and poultry and minced meat should reach 165°F (75°C).

FOOD PROBE

Setting FOOD PROBE

1

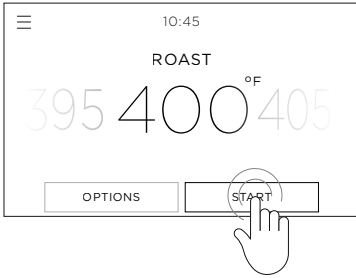

Select your function and temperature and preheat the oven if needed.

2

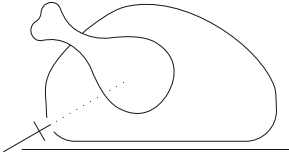

Insert the probe into your food.
Always position the tip of the probe in the thickest part of the dish, avoiding fat and bone in meat.
Ensure the tip of the probe doesn't protrude out the other side of food or touch cookware.

3

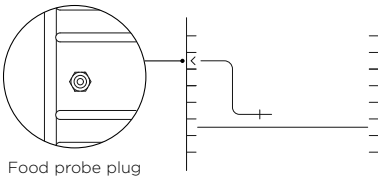

Place food in the oven and plug the probe into the socket inside the oven, on the left hand side.

4

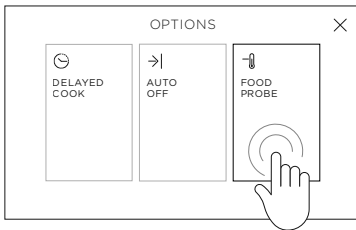

Go to the **OPTIONS** menu and select **FOOD PROBE**.

FOOD PROBE

5

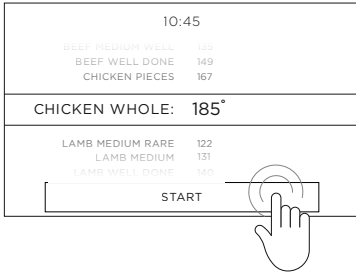

Scroll to select a food type and adjust the temperature if desired. Select **START** to begin.

6

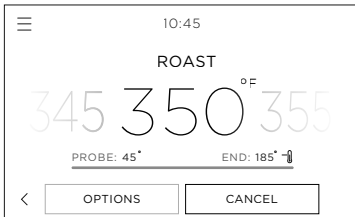

FOOD PROBE is now set.

Your oven will cook until the set temperature is reached and then turn off automatically.

7

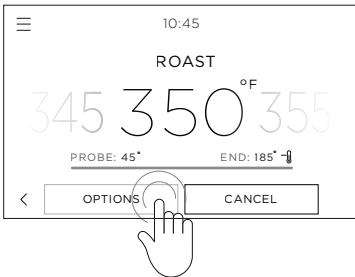

To edit or cancel

Touch **OPTIONS** and select **FOOD PROBE** at any point to edit or cancel.

When the end time is reached

The oven will automatically turn off and a tone will sound.

GUIDED COOKING

Your oven comes with guided cooking features that help you choose the optimal oven settings, accessories and methods to get the best results:



COOK BY FOOD TYPE

Optimum oven settings, shelf positions, cookware and accessories for cooking a particular type of food or cut of meat.



COOK BY RECIPE

A collection of recipes that have been specifically designed for and tested in this style of oven.

Using COOK BY FOOD TYPE

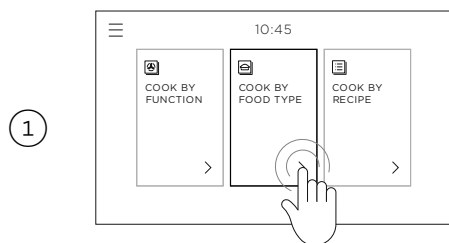

From the home screen, select **COOK BY FOOD TYPE**.

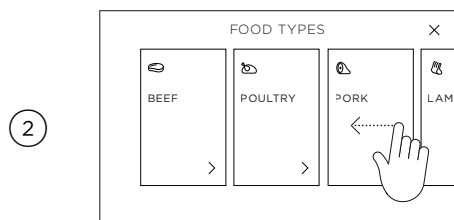

Scroll through the various food types and select the type of food you want to cook.

For more information touch the description underneath each food type.

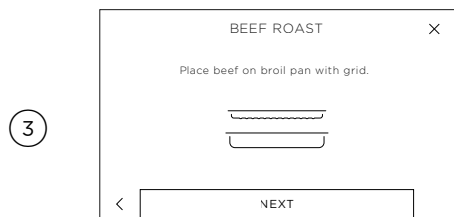

Follow the instructions onscreen for what accessories and cookware to use and how to set up your oven.

GUIDED COOKING

Using COOK BY RECIPE

1

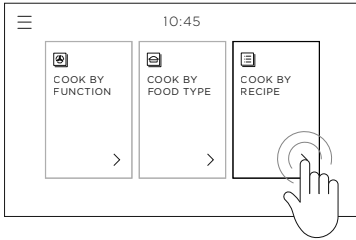

Select COOK BY RECIPE.

2

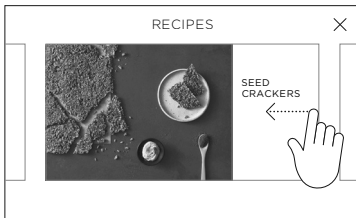

Scroll to look through the recipe collection and select your favourite.

Follow the instructions onscreen for ingredients and method, and how to set up your oven.

COOKING GUIDE

General guidelines

This oven has been designed to utilise its four elements and rear fan in different combinations to provide you with enhanced performance. The wide range of functions, allows you to cook all food types to perfection.

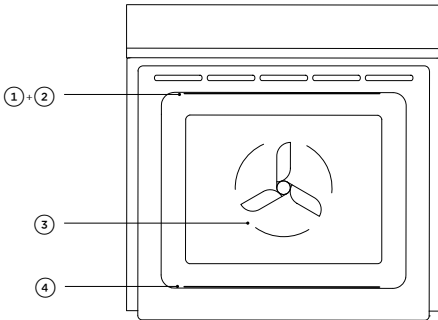

Oven elements

- ① upper outer element
- ② upper inner element
- ③ rear element (concealed)
- ④ lower element (concealed)

IMPORTANT!

Use all the functions with the oven door closed.

Baking

- For best results when baking, always pre-heat your oven. The screen will show a red progress bar while the oven is heating up.
- **Single shelf cooking:** place your baking on a shelf that will position the top of your pan near the centre of the oven.
- **Multi shelf cooking:** Always leave a space between shelves to allow the air to circulate.

Broiling

- Always broil with the oven door completely shut.
- Always keep a close watch on your food to avoid charring or burning.
- If you use glass or ceramic pans, be sure they can withstand high oven temperatures.
- For thinner cuts of meat, or for toasting or browning foods, use a higher shelf position.
- Thicker cuts of meats should be broiled on lower shelves or at a lower broil setting to ensure even cooking.

Roasting

- The **ROAST** function is designed to brown the outside of the meat, but still keep the inside moist and juicy.
- Boneless, rolled or stuffed roasts require longer than roasts containing bones. Poultry should be well cooked with the juices running clear and a minimum internal temperature of 165°F (75°C).
- Always roast meat fat side up.
- If using a roasting bag or a covered roast dish, do not use the **ROAST** function.

COOKING GUIDE

Reheating

- **Never reheat food more than once.**
- Use Vent Bake to reheat food, or follow the instructions in **COOK BY FOOD TYPE**.
- Always reheat food to piping hot, or a minimum internal temperature of 85°C. This reduces the risk of contamination.
- Reheat food in a dish with a lid or cover tightly with foil.
- Once hot, use the **WARM** function to keep the food warm.

Dehydrating

- Use the **DEHYDRATE** function to preserve food and create healthy snacks.
- For best results, use the roast dish with grill rack insert. Ensure food isn't laid flat and isn't overlapping. If dehydrating meat, flip halfway through to ensure even drying.
- Store dehydrated food in an airtight container after it's completely cooled.

Dough proofing

- Use the **RAPID PROOF** function to proof dough for breadmaking and pizza.
- Place dough in a lightly oiled bowl and cover with plastic wrap or a clean, damp cloth. Position in the centre of the oven.
- To prevent overproofing check the dough every 30 minutes.

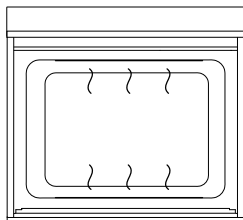

BAKE upper outer and lower elements

Ideal for:

foods that require a longer cooking time, eg rich fruit cake, brownies, or bread in combination with **VENT BAKE**.

This function will **PREHEAT** for around 12 minutes to 355°F.

- Retains moisture.
- Ideal for cakes and foods that require baking for a long time or at low temperatures.
- This function is not suitable for multi-shelf cooking.

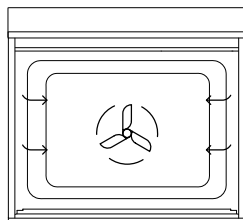

TRUE AERO fan plus rear element

Ideal for:

multi-shelf cooking, eg biscuits, cookies, scones, muffins and cupcakes.

- Hot air is blown into the cavity, providing a consistent temperature at all levels
- Always leave a gap between trays to allow air to move freely. This ensures food on the lower tray can still brown.
- If converting a recipe from **BAKE** to **TRUE AERO**, we recommend that you decrease either the bake time and/or the temperature by approximately 70°F (20°C), especially for items with longer bake times.

COOKING GUIDE

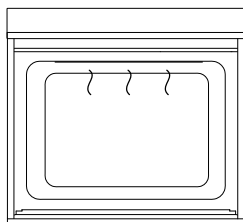

MAXI BROIL

upper inner and outer elements

Ideal for:

toasting bread or for top-browning to finish off dishes.

This function will **PREHEAT** for around 12 minutes to 355°F.

- Intense radiant heat is delivered from both top elements.
- There are 9 steps between **LO** and **HI** (100% power).
- For best results allow oven to heat for 5 minutes before broiling.
- The dial halo* will remain red while using the broil function.

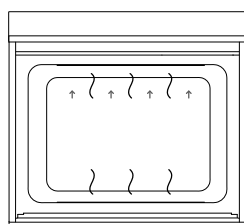

VENT BAKE

upper outer and lower elements plus venting

Ideal for:

single shelf baking such as meringues, yorkshire pudding, and finishing off choux pastry, croissants and bread.

This function will **PREHEAT** for around 12 minutes to 355°F.

- Venting removes excess moisture, reducing both steam and condensation in the oven.
- Gently browns without drying.

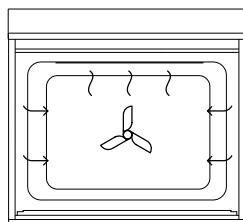

AERO BROIL

fan plus upper outer and inner elements

Ideal for:

whole chicken, beef tenderloin or broiling fish or steak.

- Uses the intense heat from the elements for top-browning and the fan to ensure even cooking of foods.
- Meat, poultry and vegetables cook beautifully; food is crisp and brown on the outside while the inside remains moist and tender.

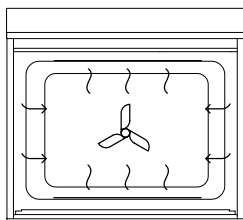

AERO BAKE

fan plus upper outer and lower elements

Ideal for:

single shelf baking that requires less than an hour to cook. Foods such as muffins, biscuits and cupcakes.

This function will **PREHEAT** for around 12 minutes to 180°C.

- The oven fan circulates hot air from the top outer and the lower elements and distributes it around the oven cavity.
- Food cooked tends to brown quickly.

*some models only

COOKING GUIDE

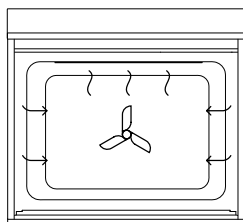

ROAST fan plus upper and lower elements

Ideal for:

roasting meat and vegetables.

This is a two-step program.

- **Searing:**

An initial 20-minute stage that crisps and browns the roast, and caramelises the outside of the meat.

- **Cooking at preset temperature:**

After searing, the temperature will decrease to your preset level for the remainder of the cook time, producing a tender and juicy roast.

- The oven does not need preheating.
- If desired, use the broil pan and grid, or place vegetables under the roast to allow the juices to drain away from your meat. This will allow the hot air to circulate under the meat as well.

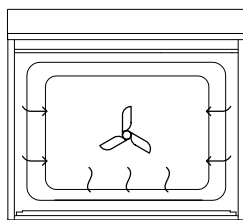
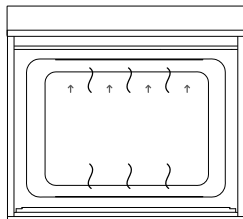

PIZZA BAKE fan plus lower element

Ideal for:

crisp-based pizzas

This function will **PREHEAT** for around 12 minutes to 355°F.

- The fan circulates heat from the lower element throughout the entire oven.
- Excellent for cooking pizza as it crisps the base beautifully without overcooking the topping.
- For best results, pre-heat a pizza stone for at least 1 hour and bake on oven shelf position 2 or 3.

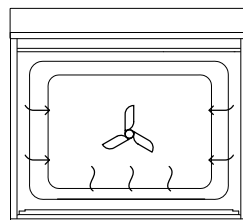

PASTRY BAKE fan plus lower element

Ideal for:

sweet and savoury pastry foods and delicate foods that require a crisp base and some top-browning, eg frittata, quiche.

This function will **PREHEAT** for around 12 minutes to 355°F.

- The fan circulates heat from the lower element throughout the oven.
- Provides intense heat to the base of foods and allows gentle top-browning.

*some models only

COOKING GUIDE

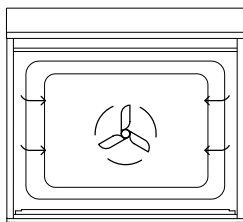

SLOW COOK fan plus rear element

Ideal for:

slow-cooked dishes such as casseroles, stews and braises.

- The fan circulates heat from the rear element to gently cook food.
- This function has low energy consumption — oven lights will remain off and vents will remain closed for the duration of cooking to conserve energy (you may observe some moisture generation during this time).
- The oven does not need preheating.

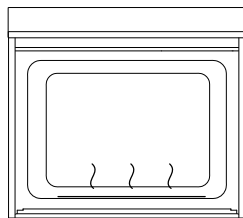

CLASSIC BAKE lower element

Ideal for:

dishes that require delicate baking and have a pastry base, such as custard tarts, pies, quiches and cheesecake.

This function will **PREHEAT** for around 12 minutes to 355°F.

- Heat comes from the lower element only.
- This is the traditional baking function, suitable for recipes that were developed in conventional ovens.
- Bake using only one shelf at a time.

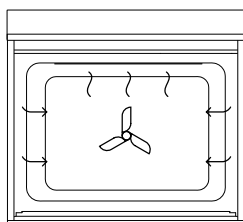

AIR FRY fan plus upper outer and inner elements

Ideal for:

food cooked from frozen, or battered and crumbed food that would usually be deep fried.

- Replicates the conditions used in an air fryer.
- A healthier way of frying which crisps food while using less oil. For best results, coat food with 1-2 tablespoons of oil.
- For pre-packaged food: if the manufacturer's cooking advice suggests using a function that isn't fan-based, decrease temperature by 70°F (20°C).
- This function is not suitable for multi-shelf cooking

COOKING GUIDE

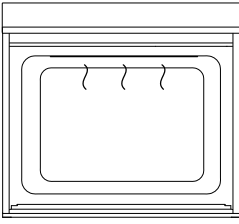

BROIL upper inner element

Ideal for:

broiling smaller quantities of toast or finishing small dishes with top browning. Position food in the centre of the shelf.

- Intense radiant heat is delivered from both top elements. There are 9 steps between LO and HI (100% power).
- For best results allow oven to heat for 5 minutes before broiling.
- The dial halo* will remain red while using the broil function.

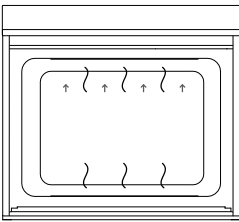

RAPID PROOF upper outer and lower elements plus venting

Ideal for:

providing the optimum warm and draft-free environment for proving yeast dough.

- Gentle heat is generated from the upper and lower elements.
- This method provides a faster proof time than at room temperature.
- For best results, cover dough to prevent surface drying.

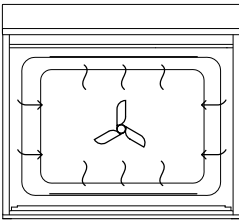

DEHYDRATE fan plus rear element

Ideal for:

drying meat, fruit, vegetables and herbs, such as beef jerky and fruit leather.

- Gently circulates air, providing a consistent low heat for dehydrating and drying food.

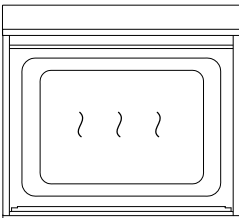

WARM upper outer and lower elements plus venting

Ideal for:

keeping cooked food hot, or to warm plates and serving dishes.

- Provides a constant low heat of less than 195°F (90°C).
- To reheat food from cold, use another function or **COOK BY FOOD TYPE** to heat the food piping hot, then change to **WARM**, as this function alone will not bring cold food up to a high enough temperature to kill any harmful bacteria.

COOKING CHARTS

Shelf positions

- Position shelves before you turn the oven on.
- Shelf positions are counted from the base up:
 - 1 is the lowest shelf position, 8 is the highest.

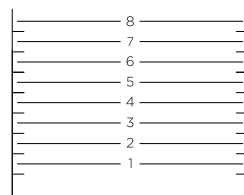

During cooking

- Preheat the oven to the required temperature.
- The grill element will come on while the oven is heating up.
- The screen will show a red temperature bar while the oven is heating up.
- Oven accessories may temporarily warp slightly when they become hot. This is normal and does not affect their function.

The information in these charts are guidelines only. Refer to your recipe or the packaging and be prepared to adjust the cooking times and settings accordingly.

BAKING	SHELVES	FUNCTION	SHELF POSITION	TEMP (°F)	TEMP (°C)	TIME (MIN)
BISCUITS						
Plain	Single	Aero Bake	4	410-430	210-220	8-10
	Multi	True Aero	3 and 6	420-450	215-230	10-12
Chewy choc chip	Single	Aero Bake	4	355-375	180-190	10-15
	Multi	True Aero	3 and 6	320-340	160-170	10-15
Sugar cookies	Single	Aero Bake	3	350-375	175-190	7-15
	Multi	True Aero	3 and 6	320-350	160-175	7-15
CAKES						
Pound cake	Single	Bake	3	350	175	20-25
Butter/chocolate	Single	Bake	3	320-360	160-180	50-60
Angel food cake	Single	Bake	3	320-350	160-175	50-60
Rich fruit	Single	Bake	3	275-300	135-150	3-6 hrs
Sponge (single large)	Single	Bake	3	350	175	30-40
Sponge (2 small pans)	Single	Bake	3	340-375	170-190	15-25
Brownie	Single	Bake	4	360	180	30-40
BANANA BREAD/CAKE	Single	Vent Bake	4	375	190	60-70

COOKING CHARTS

BAKING	SHELVES	FUNCTION	SHELF POSITION	TEMP (°F)	TEMP (°C)	TIME (MIN)
MUFFINS/CUPCAKES	Single	Aero Bake	4	365	185	13 - 18
	Multi	True Aero	3 and 6	340	170	13 - 18
ENGLISH SCONES	Single	Bake	4	425 - 430	215 - 230	10 - 12
MERINGUES	Single	Vent Bake	4	210 - 250	100 - 120	60
BREAD						
Rolls	Single	Bake then Vent Bake	4	385 - 410	195 - 210	25 - 35
Loaf	Single	Bake	3	375-410	190 - 210	30 - 40
PASTRY						
Pastry shell (blind baked)	Single	Pastry Bake	3	400	200	15 - 20
Phyllo	Single	Aero Bake	4	375 - 400	190-200	15 - 25
Flaky/puff	Single	Aero Bake	4	365 - 400	185-200	20 - 30
Choux	Single	Bake then Vent Bake	4	400 - 410	200-210	30 - 40
	Multi	True Aero	3 and 6	360 - 400	180-200	30 - 35
Croissants	Single	Bake then Vent Bake	4	375 - 400	190-200	15 - 25
	Multi	True Aero	3 and 6	375 - 400	190-200	15 - 25
PIES						
Fruit pie (double crust)	Single	Aero Bake	3	350 - 400	175-200	20-25
Baked cheesecake (in waterbath)	Single	Classic Bake	3	320	160	50 - 60
Pumpkin pie (blind baked, then filled)	Single	Classic Bake	3	350 - 375	175-190	15 - 30
English custard tart (blind baked, then filled)	Single	Classic Bake	3	350 - 375	175-190	15 - 30
Crème brulee (in waterbath)	Single	Classic Bake	4	275	135	35 - 45
Crème Caramel (in waterbath)	Single	Classic Bake	4	350	175	35 - 45

COOKING CHARTS

BROILING	SHELVES	FUNCTION	SHELF POSITION	TEMP (°F)	TEMP (°C)	TIME (MIN)
BEEF						
Steak, rare	Single	Aero Broil	5	450	230	10-15
Steak, medium	Single	Aero Broil	5	450	230	15-20
Burgers	Single	Maxi Broil	6	HI	HI	12-15
Meatballs	Single	Maxi Broil	6	HI	HI	12-15
LAMB						
Chops, medium	Single	Maxi Broil	6	HI	HI	15-20
Chops, well done	Single	Maxi Broil	6	HI	HI	20-25
CHICKEN						
Boneless pieces	Single	Aero Broil	5	350-375	175-190	30-50
PORK						
Chops, well done	Single	Maxi Broil	6	HI	HI	15-20
Ham steak	Single	Maxi Broil	6	HI	HI	15-20
Bacon	Single	Maxi Broil	6	HI	HI	4-7
SAUSAGES	Single	Maxi Broil	6	HI	HI	10-15
FISH						
Filletts	Single	Aero Broil	6	400-425	200-220	8-12
Whole	Single	Aero Broil	6	400-425	200-220	15-20
VEGETABLES						
Sliced	Single	Maxi Broil	4	HI	HI	8-12
SAVOURY						
CORNBREAD	Single	Aero Bake	4	400-425	200-220	20-25
VEGETABLES	Single	Vent Bake	4	350-375	175-190	30-50
LASAGNE	Single	Aero Bake	4	350-375	175-190	35-40
QUICHE	Single	Pastry Bake	3	350	175	15-30

COOKING CHARTS

SAVOURY	SHELVES	FUNCTION	SHELF POSITION	TEMP (°F)	TEMP (°C)	TIME (MIN)
PIZZA						
Classic	Single	Pizza Bake	2 or 3	440-485	225-250	15-25
Thin crust	Single	Pizza Bake	2 or 3	540	280	20-30
Deep dish	Single	Pizza Bake	3	320-430 ¹	160-220 ¹	50-60
CASSEROLES						
	Single	Slow Cook	2	250-300	120-150	2-4 hrs
POTATOES						
Traditional Baked	Single	Bake	4	390	200	50-60
FRITTATA						
Broil to finish	Single	Pastry Bake	4	340-360	170-180	30-45
OVEN MEALS						
	Single	True Aero	4	340-375	170-190	30-40

ROASTING	SHELVES*	FUNCTION	SHELF POSITION	TEMP (°F)	TEMP (°C)	TIME** (MIN)
BEEF, BONELESS (times per 1lb/450g)						
Rare	Single*	Roast/Vent Bake	2	320-340	160-170	18-32
Medium	Single*	Roast/Vent Bake	2	320-340	160-170	25-40
Well done	Single*	Roast/Vent Bake	2	320-340	160-170	30-55
PRIME RIB ROAST (times per 1lb/450g)						
Rare	Single*	Roast/Vent Bake	2	320-340	160-170	15-30
Medium	Single*	Roast/Vent Bake	2	320-340	160-170	20-35
Well done	Single*	Roast/Vent Bake	2	320-340	160-170	25-40
LAMB LEG, BONE IN (times per 1lb/450g)						
Medium	Single*	Roast/Vent Bake	2	320-340	160-170	18-28
Well done	Single*	Roast/Vent Bake	2	320-340	160-170	20-33
LAMB LEG, BONELESS (times per 1lb/450g)						
Medium	Single*	Roast/Vent Bake	2	320-340	160-170	20-35
Well done	Single*	Roast/Vent Bake	2	320-340	160-170	25-45

COOKING CHARTS

ROASTING	SHELVES*	FUNCTION	SHELF POSITION	TEMP (°F)	TEMP (°C)	TIME** (MIN)
CHICKEN (WHOLE) (times per 1lb/450g)						
With stuffing	Single*	Roast/Vent Bake	2	350-375	175-190	17-22
Without stuffing	Single*	Roast/Vent Bake	2	350-375	175-190	15-20
Butterflied	Single*	Roast/Vent Bake	2	350-375	175-190	15-20
TURKEY, WHOLE (times per 1lb/450g)						
With stuffing	Single*	Vent Bake/Bake	1	330-400	165-180	17-22
Without stuffing	Single*	Vent Bake/Bake	1	300-330	150-165	15-20
PORK CRACKLING						
Crisp		Vent Bake	4	485	250	20
VEAL (times per 1lb/450g)						
Medium	Single*	Roast/Vent Bake	2	320-340	160-170	20-40
Well done	Single*	Roast/Vent Bake	2	320-340	160-170	25-45
PORK, BONELESS (times per 1lb/450g)						
Medium	Single*	Roast/Vent Bake	2	340-350	170-175	25-40
Well done	Single*	Roast/Vent Bake	2	340-350	170-175	30-45
VENISON (times per 1"/2.5cm thickness ²)						
Rare	Single*	Aero Broil	4	435	225	7.5
Medium	Single*	Aero Broil	4	435	225	9.5
AIRFRYING						
POTATOES						
Hash browns	Single*	Air Fry	4	410	210	15-20
Fries	Single*	Air Fry	4	410	210	15-20
ONION RINGS	Single*	Air Fry	4	375	190	15-20
FISH						
Battered/crumbed	Single*	Air Fry	4	360	180	15-20
CHICKEN						
Nuggets	Single*	Air Fry	4	360	180	15-20

COOKING CHARTS

DEHYDRATING	SHELVES	FUNCTION	SHELF POSITION	TEMP (°F)	TEMP (°C)	TIME (HOURS)
HERBS						
Rosemary/dill/thyme	Multi	Dehydrate	3 and 6	95	35	3-4
FRUIT						
Apples/pears	Multi	Dehydrate	3 and 6	140	60	6-8
VEGETABLES						
Carrots/beans	Multi	Dehydrate	3 and 6	140	60	6-8
MEAT						
Beef jerky	Multi	Dehydrate	3 and 6	160	70	4-6

¹ Start at 430°F (220°C) for 10 minutes, and lower to 320°F (160°C) for further 50 minutes

² Brown in frying pan first

* If multiple shelves are required (eg roasting vegetables at the same time), use **TRUE AERO** and shelf positions 3 and 5.

Alternatively use the food probe and internal temperature settings or **COOK BY FOOD TYPE.

USER PREFERENCE SETTINGS

The settings menu allows you to adjust your user preferences to:

- Change the time
- Change the clock format (12 hours, 24 hours or off)
- Display the temperature in degrees Celsius or Fahrenheit
- Adjust the volume of audio feedback
- Turn timer alarms on or off
- Turn audio tones on or off
- Operate in Sabbath Mode
- Change the language of the display
- Manage your WiFi connection
- Adjust the brightness of the display
- Manage dial settings*:
 - Change the dial scroll direction (some models only)
- Restore all settings to factory original

IMPORTANT!

- You cannot change the settings when your oven is cooking or has any automatic cooking options set.
- Tones and alarms will still sound for faults if audio settings are turned off.

USER PREFERENCE SETTINGS

Changing the settings

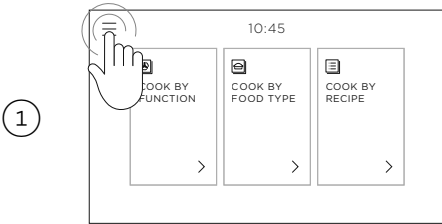

Touch the menu icon in the top left corner of the screen.

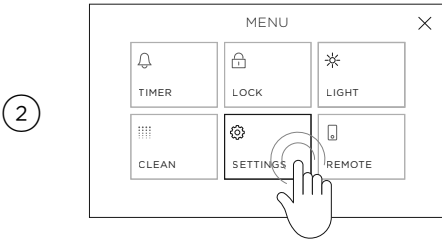

Select **SETTINGS**.

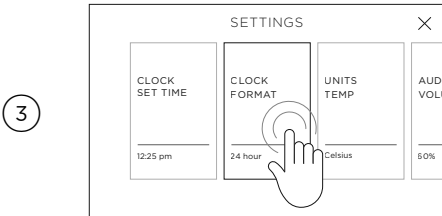

Select the setting you want to change, adjust as needed then select **CONFIRM**.

WIFI CONNECTION AND REMOTE MODE

Your oven can be connected to your home wireless network and operated remotely using the **FISHER & PAYKEL** app.

Getting started

- Ensure your home WiFi network is turned on.
- You will be given step by step guidance on both your oven and mobile device.
- It may take up to 10 minutes to connect your oven.

Connecting to your home wifi

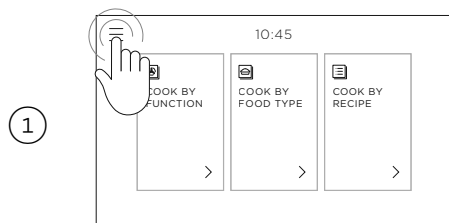

Touch the menu icon in the top left corner of the screen.

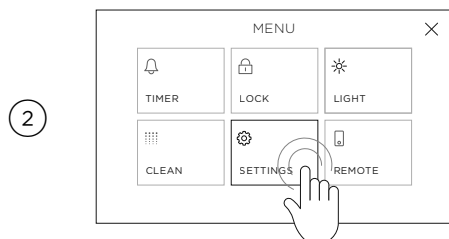

Select **SETTINGS**.

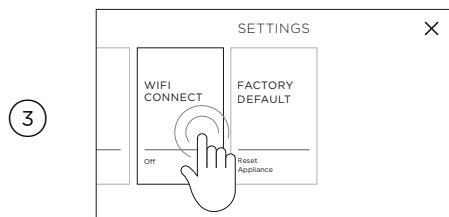

Select **WIFI CONNECT** and follow the onscreen guidance.

On your mobile device:

- ① Download the **FISHER & PAYKEL** app from www.fisherpaykel.com/connect
- ② Register and create an account.
- ③ Add your appliance and set up the WiFi connection.

WIFI CONNECTION AND REMOTE MODE

Enabling Remote Mode

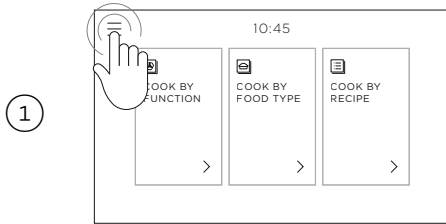

Touch the menu icon in the top left corner of the screen.

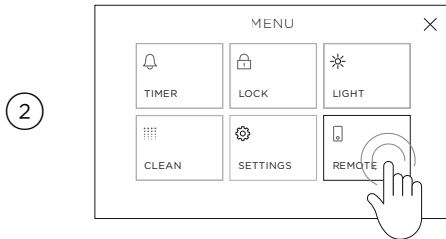

Select **REMOTE**.

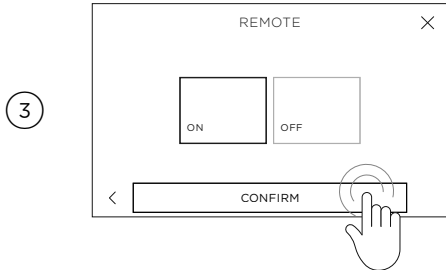

Select **ON** then press **CONFIRM**.
REMOTE MODE is now enabled.

SABBATH MODE

This setting is designed for religious faiths that observe a 'no work' requirement on the Sabbath.

While your oven is in Sabbath Mode it will not have the usual accurate temperature control:

HEAT LEVEL	APPROXIMATE TEMP (°C)	APPROXIMATE TEMP (°F)	APPLICATION
Low	75 - 100	170 - 210	Keep hot food warm
Moderate	155 - 180	310 - 360	Reheat cooked food from cold
High	185 - 210	360 - 410	Cooking raw food

While your oven is in Sabbath Mode:

- the oven will not react to any actions
- lights, fans and display will not respond to the door opening
- if the door is open for too long, this may result in loss of temperature
- no tones or alarms will sound and alert codes or temperature changes will not be displayed
- the oven light can be set to remain either on or off
- the oven will remain in Sabbath Mode until cancelled
- **CLASSIC BAKE** is the only function available

Setting Sabbath Mode

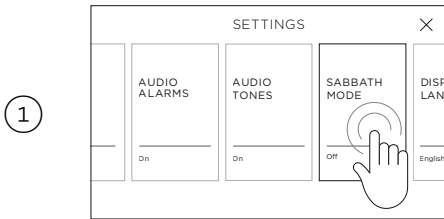

In the settings menu select **SABBATH MODE** and follow the instructions on the screen.

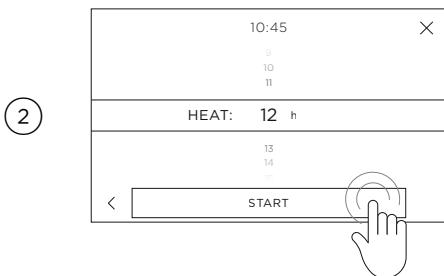

Set your desired heating level and select whether you want the oven light **ON** or **OFF** during cooking.

Scroll to set your desired cook time and then select **START**. You can set the oven to heat for up to 73 hours.

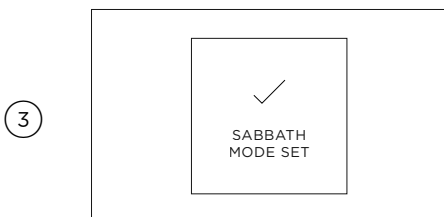

Sabbath Mode is now set.

The oven will heat for the set length of time and then turn off.

The oven will remain in Sabbath Mode until it is cancelled.

SABBATH MODE

Cancelling Sabbath Mode

1

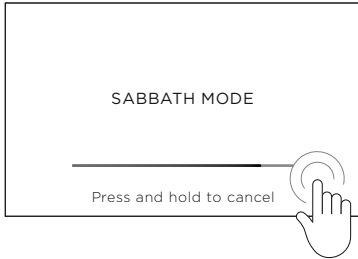

Touch and hold the screen until the bar fills.

2



SABBATH MODE CANCELLED will appear and you can now use your oven normally.

CARE AND CLEANING

Manual cleaning

ALWAYS	NEVER
<ul style="list-style-type: none"> • Before any manual cleaning or maintenance, first wait for the oven to cool down to a safe temperature to touch, then turn its power supply off at the wall. • Read these cleaning instructions and the 'Safety and warnings' section before you start cleaning your oven. • To prevent soiling from becoming 'baked on' and stubborn, we recommend removing any easy-to-reach spills, food or grease stains from the oven cavity enamel after each use. • Always clean the inner glass pane before starting a Self Clean cycle. Failure to do this will mean that residue will bake on and be impossible to remove. • Always remove oven shelves before starting a Self Clean cycle. 	<ul style="list-style-type: none"> • Never use a steam cleaner. • Never store flammable substances in the oven. • Never use abrasive or harsh cleaners, cloths, scouring pads or steel wool. Some nylon scourers may also scratch. Check the label first. • Never use oven cleaner on catalytic panels or in a pyrolytic oven. • Never leave alkaline (salty spills) or acidic substances (such as lemon juice or vinegar) on the oven surfaces. • Never use cleaning products with a chlorine or acidic base. • Never spray detergent or liquid onto the dial* or control panel.

WHAT?	HOW?	IMPORTANT!
Oven cavity	<ul style="list-style-type: none"> • To clean light soiling off the enamelled surfaces wipe with a damp cloth and a solution of hot water and mild detergent before drying with a soft cloth. • To clean stubborn soiling or the whole oven cavity use the Self Clean function. See 'Using the Self Clean function' for instructions. 	<ul style="list-style-type: none"> • To prevent soiling from becoming 'baked on' and stubborn, we recommend removing any easy -to-reach spills, food or grease stains from the enamelled surfaces after each use. Doing so will reduce the need for using the Self Clean function frequently.
Telescopic sliding shelf supports	Clean with a solution of mild detergent and hot water, then dry.	Do not wash these in the dishwasher. Immerse in soapy water and use oven cleaner on them or leave in the oven during a Self Clean cycle.
Dials	Clean with a solution of mild detergent and hot water, then dry.	Do not use stainless steel or oven cleaner on the dial, as doing so may damage it's coating.

CARE AND CLEANING

WHAT?	HOW?	IMPORTANT!
Stainless steel strip/ handle on the front of the oven door	Clean with a solution of mild detergent and hot water, then wipe dry with a microfibre cloth. If necessary, use a suitable stainless steel cleaner and polish.	Always read the label to make sure that your stainless steel cleaner does not contain chlorine compounds as these are corrosive and may damage the appearance of your oven. Always rub the stainless steel in the direction of the grain.
Food Probe	Clean with a solution of mild detergent and hot water, then wipe dry with a microfibre cloth.	Clean after every use to avoid contamination. Do not wash in the dishwasher, immerse in soapy water, use oven cleaner or leave in the oven during a Self Clean cycle.
Oven seal	Do not clean this part.	Do not rub, damage or remove the seal as it is important for ensuring your oven runs efficiently.
Oven vent louvres	Wipe with a damp cloth.	Take care not to let any liquid run down the louvres of the oven vent.
Full extension sliding shelf	Wipe with a damp cloth and mild detergent. Do not wipe off or wash away the white lubricating grease (visible when the shelf is extended).	Never leave this shelf in the oven during a Self-clean cycle. Do not wash the shelf in the dishwasher, immerse in soapy water, or use oven cleaner on it. Doing so will prevent the slides from running smoothly.
Grid Grill rack Grill Pan Side racks Baking tray	Clean with a solution of mild detergent and hot water. Pre-soak stubborn burnt-on stains in a solution of dishwasher powder and hot water. These parts are also dishwasher safe.	Never leave any of these parts in the oven during a Self clean Cycle (except for the side racks). They will become discolored or damaged.
Oven door glass (after every use)	Use a soft cloth and a mixture of warm water and dishwashing liquid to remove soiling after every use. For stubborn stains, try a mixture of baking soda and warm water with a non-abrasive scrubbing pad, then wipe dry with a soft, lint-free cloth.	Do not use oven cleaners or any other harsh/abrasive cleaners, cloths, scouring pads, steel wool or sharp metal scrapers to clean the oven door glass. These scratch the glass, which in turn could result in the glass cracking and shattering. Do not allow grease to build up on the glass or become baked on as this reduces visibility into the oven.

CARE AND CLEANING

Removing the side racks

Remove the side racks to make cleaning the oven easier. The side racks can be left in the oven during Self Clean.

IMPORTANT!

Always turn the oven off at the wall first. Ensure the oven has cooled down completely before starting.

1

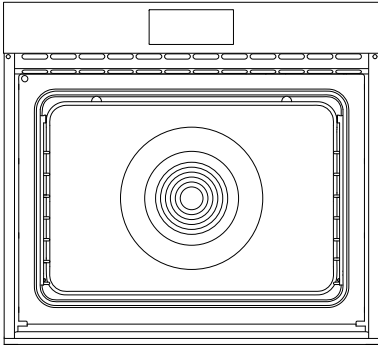

Slide out all shelves and remove.

2

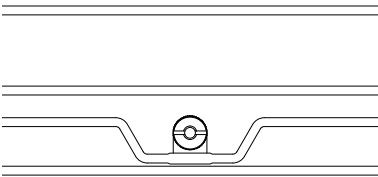

Unscrew the fixing nut holding the side rack in position. A coin may be used to loosen.

3

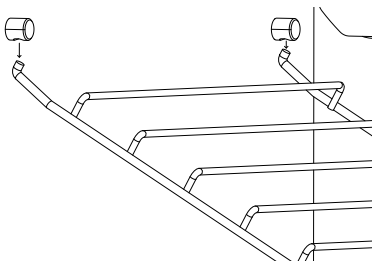

Swing the bottom of the side rack up towards the center of the oven until it is almost horizontal. Slide the prongs at the top out of the mounting slots.

CARE AND CLEANING

Refitting the side racks

IMPORTANT!

Always turn the oven off at the wall first. Ensure the oven has cooled down completely before starting.

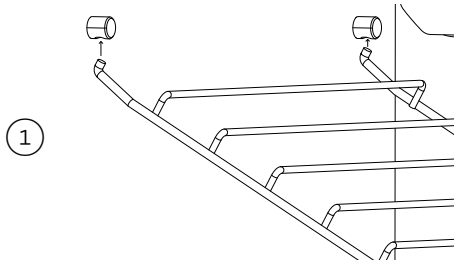

Supporting the side rack from underneath, hold it almost horizontally and locate the prongs into the mounting slots.

If at anytime during the lowering of the side rack you feel resistance, re-adjust the prongs to ensure they are fully inserted. There should be no resistance.

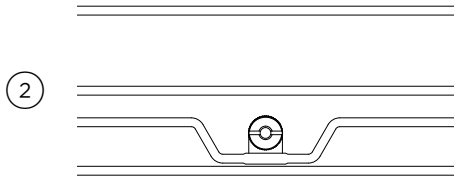

Ensure the prongs are fully inserted into the slots before lowering the side rack carefully and refit the fixing nut. It is important to ensure the tab behind the fixing nut sit flush against the wall. A coin may be used to tighten.

CARE AND CLEANING

Changing the oven light bulbs

The oven is illuminated by three 12 volt/20 watt halogen bulbs. These have a very long life, but if you should need to replace one, use only a replacement bulb purchased from your nearest Fisher & Paykel dealer and follow these steps:

- ① Allow the oven to cool and then turn it off at the wall.
- ② Take out the shelves and side racks (see 'Side racks') and use a small flat-head screwdriver to twist and lift the retainer clip at the top of the glass light cover while holding the glass to prevent it falling. The clip pivots anti-clockwise (see the diagram).
- ③ Carefully lift the glass cover out of the lower support and pull out the faulty bulb.
- ④ Holding the replacement bulb in a soft cloth or tissue (touching the bulb will reduce its life span), insert the new bulb.
- ⑤ Reposition the glass cover and twist the top clip back in place. The procedure is the same for the light in the roof of the oven cavity.

Note: oven bulb replacement is not covered by your warranty.

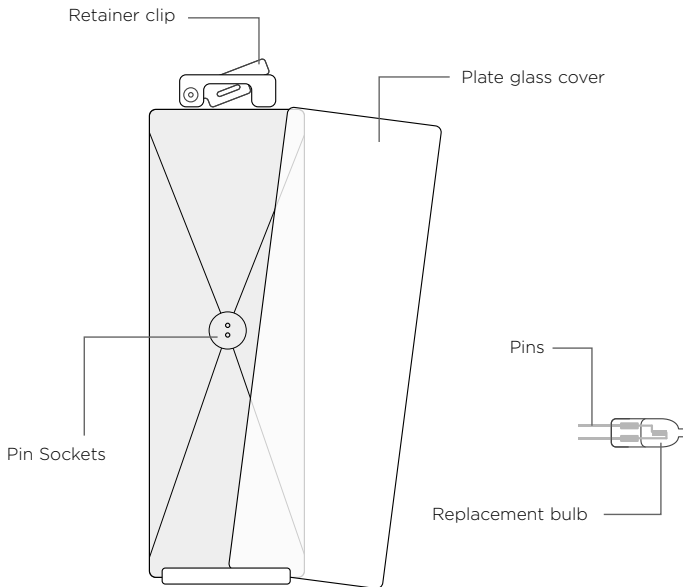

CARE AND CLEANING

Removing and refitting the oven door

IMPORTANT!

- Take care, the oven door is heavy.
- Do not lift the oven door by its handle. Doing so may damage the door.
- Ensure the oven and the door are cool before you begin to remove the door.
- Before removing the door, ensure there is a large enough clear, protected surface in the kitchen to rest the door on.

To remove the door

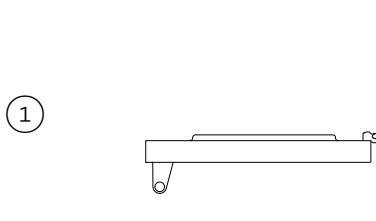

Open the door completely.

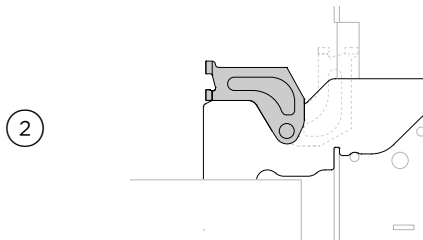

Open the hinge locks fully on both sides

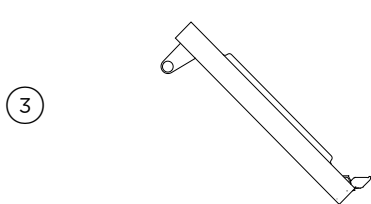

Holding the door on both sides, lift door back up to 45° and carefully pull the door out and away from the hinges.

CARE AND CLEANING

To refit the door

1

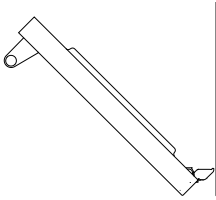

Holding the door at 45°, carefully align the hinge tongues with the hinge slots. Push the door in until you feel the latches locate into position on each side

2

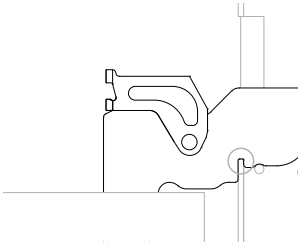

Open the door completely and ensure both hinges are secured by the correct notches.

3

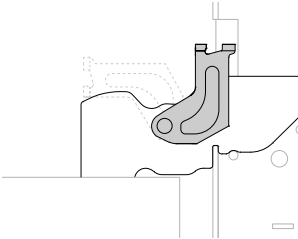

Rotate the locks up into the closed position ensuring they rest inside the slots completely. Note: Incorrect installation will prevent door from correctly sealing.

4

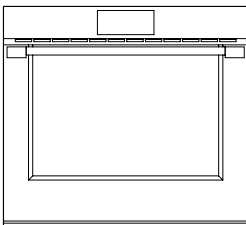

Close the oven door ensuring that when closed, the door is vertical and parallel to any surrounding cabinetry

USING SELF CLEAN

Self Clean takes care of the mess and grime that is traditionally associated with oven cleaning. The extremely high temperature of the pyrolytic clean cycle burns off and breaks down grease and grime deposits. All that is left is a small amount of ash that can easily be wiped up.

There are two clean cycles available:

STANDARD CLEAN (4 hours)
For normal or heavy soiling

LIGHT CLEAN (3 hours)
For light soiling

IMPORTANT!

- You must clean the inside glass door panel **BEFORE** starting a clean cycle. Failure to do so may result in permanent staining or marking of the door glass. See 'Care and cleaning' for our recommendations on how to do this.
- Do not use oven cleaners, any degreasing cleaners, or oven liners.
- Remove all oven shelves, trays, bakeware and utensils from the oven before starting a clean cycle (except side racks). If left in the oven they will be permanently damaged; items made from combustible material (eg wood, fabric, plastic) may even catch fire.
- Do not use your oven to clean miscellaneous parts.
- Make sure the room is well ventilated.
- Before starting a clean cycle, make sure you move any pet birds to another, closed and well-ventilated room. Some pet birds are extremely sensitive to the fumes given off during a clean cycle, and may die if left in the same room.
- During a clean cycle, the oven reaches higher temperatures than it does for cooking. Under such conditions, the surfaces may get hotter than usual and children should be kept away.
- The oven door will be locked during the clean cycle.
- If there are cracks or flaws on any of the oven door glass panes, if the oven seal is damaged or worn, or if the door does not close properly, do not start a clean cycle. Contact a Fisher & Paykel trained and supported service technician or Customer Care.

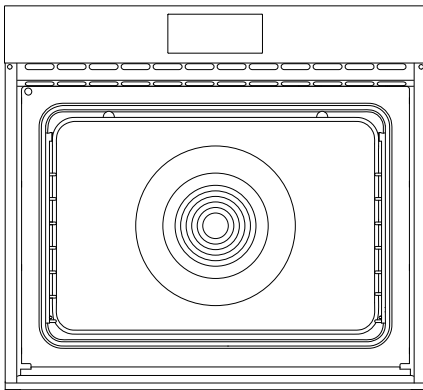

Before you start

- ① Remove all shelves, accessories and utensils. You do not need to remove the side racks.
- ② Wipe up any spills, and along the inner edge of the oven surface around the seal. Failure to do so may discolor the oven surface.

Avoid cleaning the seal itself as this may cause damage.

- ③ Check the inner glass pane of the oven door. If it has soiling on it, you will need to clean it manually before starting a Clean cycle. For instructions, see 'Care and cleaning'.

If soiling is left on the glass, it will become burnt on during the clean cycle, making it very difficult to remove.

- ④ Close the oven door firmly.

USING SELF CLEAN

1

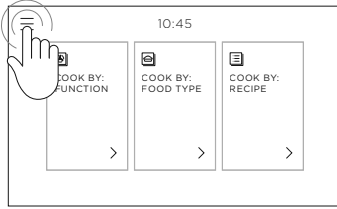

Touch the menu icon in the top left corner of the screen.

2

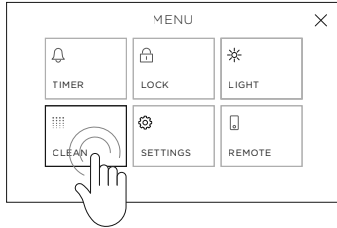

Select **CLEAN**.

3

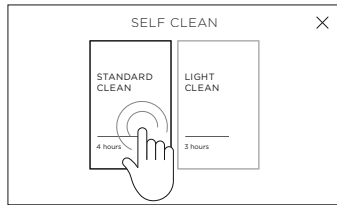

Select **STANDARD CLEAN** or **LIGHT CLEAN**.

4



Follow the on-screen instructions and press the lower button to the left of the screen to continue.

5

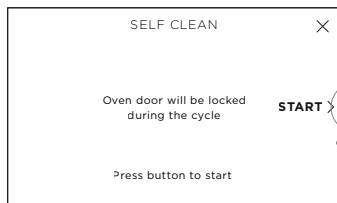

Press the middle button to the right of the screen to start the clean cycle.

For your safety, the oven door will be locked shut during the cycle. If the door is not shut properly or is reopened before Self Clean starts, the cycle will be cancelled.

USING SELF CLEAN

Cancelling Self Clean

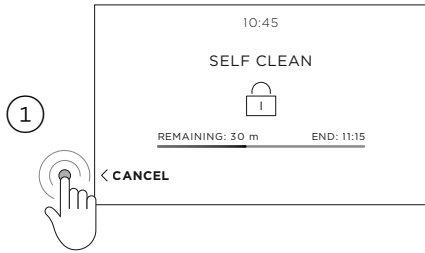

Press the flashing button to the left of the screen at any point during the clean cycle to cancel.

IMPORTANT!

- The oven door will not unlock until the oven has cooled to a safe temperature. **DO NOT** turn off the mains power supply to the oven (wall switch). Turning off the power while the oven is too hot may damage the oven and its surrounding cabinetry.
- We do not recommend cancelling Self Clean then immediately starting another cycle.

When Self Clean is finished



SELF CLEAN COMPLETE will show in the display. Touch the display to clear.

You need to:

- wait for the oven to cool down completely
- remove the grey ash with a small brush or damp cloth
- wipe out the oven with a clean, damp cloth
- dry with a clean, lint-free cloth, and
- replace the oven shelves.

TROUBLESHOOTING

If there is a problem with your oven, please check the following points before contacting your local Fisher & Paykel trained and supported service technician or the Customer Care Centre.

General

PROBLEM	POSSIBLE CAUSES	WHAT TO DO
The oven does not work	No power	Check that the mains power supply (wall switch) is turned on, the fuse has not tripped and there is no power outage in your area.
The oven does not work but the screen is on.	The oven is in Demo Mode.	Call Customer Care.
The lights do not come on when I open the oven door.	The oven light bulb(s) have blown	Replace the light bulb(s). See 'Care and cleaning' for instructions.
	The door is not correctly fitted.	See 'Care and cleaning' for instructions on fitting the door correctly.
	The oven light has been turned off.	Go to the menu in the top left corner of the screen and select LIGHT .
The oven is not heating.	The door is not properly closed or it is opened too frequently during cooking.	The heating elements are disabled while the door is open. Make sure the door is properly closed and avoid opening it frequently during cooking.
A glass pane in the oven door has cracked, chipped, or shattered.	Incorrect cleaning or the edge of the glass hitting against something.	You must NOT use the oven. Call your Authorized Repairer or Customer Care.
The oven controls are unresponsive.	The control panel is locked.	Touch and hold the screen to unlock.
I can feel hot air blowing out of the vents after I have turned the oven off.	This is normal.	For safety reasons the cooling fans will continue to run even when you have turned the oven off. The fans will switch off automatically when the oven has cooled.
The oven fan comes on when I select a function that does not use a fan (eg BAKE or CLASSIC BAKE).	This is normal. The fan comes on while the oven is preheating. It may turn off when the oven has reached the set temperature.	Wait until the red heating bar on the screen disappears: the oven will then be ready to use.

TROUBLESHOOTING

General

PROBLEM	POSSIBLE CAUSES	WHAT TO DO
The oven has reached the set temperature but the temperature dial halo is still red*.	The oven is set to MAXI BROIL .	This is normal. The dial halo* will stay red whenever this function is in use as the broil element is always heating.
The temperature dial halo never turns white when I use BROIL* .	This is normal: the halo stays red to indicate that the broil element provides instant radiant heat.	
The oven sounds a tone when I try to set the temperature below a certain temperature.	This is normal: for food safety reasons, the oven functions have factory-set minimum temperature settings.	Select a different temperature or try a different function that is designed for low temperatures.
The oven cancels automatic cooking when I try to adjust the clock setting.	The oven was set for automatic cooking when you were trying to adjust the clock setting.	You can only adjust the clock setting while the oven is not set for automatic cooking.
The displays work, and the function and temperature dials halos come on but the oven does not heat up.	The oven is in 'Demo' mode.	Call Customer Care.
The oven door does not align with the control panel or surrounding cabinetry.	The oven door has been installed incorrectly and the hinges are misaligned within the slots.	Re-install the door. See 'Removing and refitting the oven door' for instructions.
Temperature is not calibrated correctly.	Door is not sealing correctly.	Re-install the door. See 'Removing and refitting the oven door' for instructions.

TROUBLESHOOTING

Self Clean

PROBLEM	POSSIBLE CAUSES	WHAT TO DO
During Self Clean, the oven is louder than usual.	This is normal: the oven's cooling fans operate at their highest speed.	
The screen shows no time remaining but the oven door will not open.	The oven door is locked because the oven is still too hot to be used for cooking.	Wait until Self Clean has finished. If you cancelled a cycle part way through, the oven still needs to cool down before it can be used. The oven door will automatically unlock.
I have cancelled Self Clean but cannot use the oven: <ul style="list-style-type: none">the oven door will not openthe screen is still counting down minutes or showing no time remainingthe controls are unresponsive.	This is normal. If the oven is still too hot to be used for cooking the door will stay locked until it has cooled down.	Wait until the cool-down phase has finished. A long tone will sound and the oven door will automatically unlock when the oven is ready to use. Note: depending on when the clean cycle was cancelled, the cool-down phase may take up to 45 minutes.
The oven is beeping and the screen shows A2 or A3.	See section 'Alert codes' for instructions.	Follow the guidance on the screen.
There is a power cut during Self Clean.	Power cut.	The heating elements are disabled while the door is open. The door will remain locked. Once the power is turned back on, the door will remain locked until the oven has cooled to a safe temperature.

ALERT CODES

If there is a problem, the oven will automatically suspend all oven functions, beep five times and display an alert code.

IMPORTANT!

Do not turn off the mains power supply to the oven (wall switch) if you get an alert code, unless the instructions in the chart following specifically instruct you to. There are cooling fans within the oven which are needed to cool the oven's components. Turning off the power while the oven is too hot may damage the oven and its surrounding cabinetry.

What to do if an alert code is displayed

- ① If the beeping hasn't stopped already, touch the display and press the little audio button in the bottom right to mute it.
- ② Make a note of the alert code displayed. You may need this information.
- ③ Follow the instructions on the screen to resolve the problem.
- ④ If you can fix the problem and the alert code does not reappear, you can keep using your oven.

If you can't fix the problem yourself or the alert code reappears and the problem persists: wait until the cooling fans have stopped and the oven has completely cooled down, then turn the power to the oven off at the wall and contact a Fisher & Paykel trained and supported service technician or Customer Care with the alert code information.

ALERT CODE	POSSIBLE CAUSE	WHAT TO DO
A1	The oven has overheated.	<ul style="list-style-type: none">• Allow the oven to cool down.• Once the oven has cooled down and the door has unlocked, the alert code will disappear. You can now use the oven.
A2	Door lock error: the door cannot be locked after you have started a Self Clean cycle.	<ul style="list-style-type: none">• Turn the power to the oven off at the wall and on again.• Wait approximately 10 seconds. This will allow the door lock to return to its initial position.• Set the clock. See 'Setting the clock and first use' for instructions.• Try starting a Self Clean cycle again, making sure that you close the door firmly. See 'Using the Self Clean function'.
A3	Door lock error: the door cannot be unlocked after a Self Clean cycle has finished.	<ul style="list-style-type: none">• Turn the power to the oven off at the wall and on again.• Gently press the door a few times to help the door lock disengage.• If this doesn't help and the alert code reappears, contact a Fisher & Paykel trained and supported service technician or Customer Care.
F + number	Technical fault.	<ul style="list-style-type: none">• Note down the alert code.• Wait until the cooling fans have stopped and the oven has completely cooled down.• Turn the power to the oven off at the wall.• Call your Authorized Repairer or Customer Care with the alert code information.

WARRANTY AND SERVICE

Before you call for service or assistance

Check the things you can do yourself. Refer to the installation instructions and your user guide and check that:

- Your product is correctly installed.
- You are familiar with its normal operation.

If after checking these points you still need assistance or parts, please refer to the Service & Warranty book for warranty details and your nearest Service Center, Customer Care, or contact us through our website www.fisherpaykel.com

Complete and keep for safe reference:

Mode	_____
Serial No.	_____
Purchase Date	_____
Purchaser	_____
Dealer	_____
Suburb	_____
Town	_____
Country	_____

FISHERPAYKEL.COM

© Fisher & Paykel Appliances 2019. All rights reserved.

The product specifications in this document apply to the specific products and models described at the date of issue. Under our policy of continuous product improvement, these specifications may change at any time. You should therefore check with your Dealer to ensure this booklet correctly describes the product currently available.

US CA

592102A 11.19