

FISHER & PAYKEL

HEAT PUMP CLOTHES DRYER

DH9060FS

USER GUIDE

NZ AU

CONTENTS

Safety and warnings	5
Control panel	9
WiFi connection & remote mode	12
Dry cycles	14
Dry preparation	16
Getting started quickly	19
Dry cycle options	21
Customising a dry cycle	23
Dryer settings	27
Caring for your dryer	29
Before you call for service	36
Fault codes	37
Troubleshooting	38
Manufacturer's warranty	44
Customer care	46

Registration

To register your product visit our website: fisherpaykel.com/register

⚠ WARNING!



Electric Shock Hazard

Failure to follow this advice may result in electric shock or death.

- If you are using an extension cord or a portable electrical outlet device (eg multi-socket outlet box), ensure that it is positioned so that it does not come into contact with water or moisture.

⚠ WARNING!



Fire Hazard

- Only dry fabrics that have been washed with water.
- Do not use heat to dry articles containing foam rubber or similarly textured rubber-like materials, dry on 'Cool Dry'.
- Never stop a tumble clothes dryer before the end of the drying cycle unless all items are removed and spread out in order to dissipate the heat.
- A clothes dryer produces combustible lint; the lint filter must be cleaned before each drying cycle.
- Failure to follow the warnings outlined in these user instructions can cause a fire hazard.
- Failure to follow these instructions can result in death or personal injury.

READ AND SAVE THIS GUIDE

When using your clothes dryer, follow basic precautions, including the following:

General

- The appliance must not be supplied through an external switching device, such as a timer, or connected to a circuit that is regularly switched on and off by a utility.
- We do not recommend the use of extension cords or portable electrical outlet devices for safety reasons.

SAFETY AND WARNINGS

- Do not touch or operate the machine with wet hands or with bare-feet.
- A damaged power cord must be replaced by a Fisher & Paykel trained and supported service technician, its service agent or similarly qualified persons in order to avoid a hazard. The appliance must not be operated until it is repaired, as there is risk of electric shock.
- Do not operate this machine if it has been damaged during transport. Contact your Fisher & Paykel dealer or Fisher & Paykel trained and supported service technician.
- This dryer has been designed for domestic use only, not for commercial applications, such as massage/beauty clinics where there may be increased lint accumulation or flammable materials in the atmosphere or load.
- The tumble dryer is intended only for drying textile material washed in water.
- Undergarments that contain metal reinforcements should not be placed in the dryer. Damage to the dryer can result if the metal reinforcements come loose during drying. If you wish to dry these items use a drying rack or place in a garment bag.
- Check and remove all objects from pockets, eg lighters and matches.
- Never dry rubber articles, or any plastic items or film, eg plastic lined tablecloths and baby bibs.
- Clothes should go through the cool down/airing phase in the final part of the cycle. This ensures items are left at a temperature where they will not be damaged. If for any reason the dryer is stopped before the cycle has finished, dry clothes should be removed immediately and not left in the dryer. Clothes should be quickly spread out flat to cool so heat can dissipate, not left bunched up, eg in a clothes basket.
- Do not operate this product without the lint filter in place or allow lint to accumulate in or around the dryer.
- This dryer is not intended for use by persons (including children) with reduced physical, sensory or mental capabilities, or lack of experience and knowledge, unless given supervision or instruction concerning the use of the dryer by a person responsible for their safety.
- Children should be supervised to ensure they do not play with the dryer.
- Unplug the machine from the power supply when it is not in use.
- Do not swing on or put weight on the door.
- In the event of a power outage your dryer will resume automatically when power is restored.
- Never attempt to repair the dryer yourself.
- The only user-removable parts of the dryer are the filters and drying rack. No other parts are designed to be removed by anyone other than a Fisher & Paykel trained and supported service technician.
- For problems that cannot be solved from information in this user guide, turn off and unplug your dryer and contact a Fisher & Paykel trained and supported service technician.
- Do not overload your dryer beyond its rated capacity:

MODEL	MAXIMUM CAPACITY (KG)
DH9060FS	9

*Capacity refers to the maximum dry weight of items the dryer can dry at any one time

- Never put dripping wet clothes in or on top of the dryer as excess water may cause an electrical hazard.
- Do not under any circumstances dry an electric blanket or any other electrical, plastic or rubber items in your dryer, unless the care label specifically states it is safe to do so. Never dry these items at high temperatures.

SAFETY AND WARNINGS

- Do not dry curtains in your dryer. Sunlight makes them brittle and they may disintegrate during drying.
- Do not use the water collected in the water tank for drinking or food processing.
- Never run the dryer without the water tank in place.
- If the water tank becomes full, the tumble dryer will pause drying and will sound an alarm. You must empty the water tank before the dryer can continue drying. Empty the tank, replace it back in the housing then press ►|| to resume the cycle.

Lint

- Accumulated lint in the dryer can become a fire hazard; it also reduces the efficiency of the dryer by causing longer drying times and increased power consumption.
- Clean the lint filter before every load.
- Ensure the area around the dryer is clear of lint.
- At regular intervals have the interior of the dryer cleaned of any accumulated lint. This must be done by a Fisher & Paykel trained and supported service technician. This must be done when the dryer installation is changed from free standing.
- If the lint filter becomes damaged, contact your Fisher & Paykel trained and supported service technician to arrange getting a new filter. Do not operate your dryer with a damaged lint filter or without the filter in place, as this will cause damage to your dryer.

Spontaneous combustion

To reduce the risk of fire in a tumble dryer the following should be observed:

- Items that have been spotted or soaked with vegetable oil or cooking oil are a fire hazard and should not be placed in a tumble dryer.
- Oil-affected items can ignite spontaneously, especially when exposed to heat sources such as a tumble dryer. The items become warm causing an oxidation reaction in the oil. This oxidation creates heat. If the heat cannot escape the items can become hot enough to catch fire. Piling, stacking or storing oil-affected items can prevent heat from escaping creating a fire hazard.
- If it is unavoidable that fabrics that contain vegetable oil, cooking oil or have been contaminated by hair care products be placed in a tumble dryer, they should first be washed in hot water with extra detergent—this will reduce, but not eliminate the fire hazard. The cool down cycle of the dryer should be used to reduce the temperature of these items. They should not be removed from the tumble dryer and piled or stacked while hot.
- Items that have previously been cleaned in, washed in, soaked in or spotted with flammable liquids or solids, eg petrol/gasoline, kerosene, dry cleaning solvents, vegetable or cooking oil, acetone, denatured alcohol, some brands of spot removers, turpentine, waxes and wax removers or other flammable or explosive substances should not be placed in a tumble dryer.
- Do not dry unwashed items in the tumble dryer.
- The dryer is not to be used if industrial chemicals have been used for cleaning.
- Fabric Softeners or similar products should not be used in a tumble dryer to eliminate the effects of static electricity, unless this practice is specifically recommended by the manufacturer of the fabric softener product.
- Rubber backed articles, foam rubber (latex foam), clothes or pillows fitted with foam rubber pads, fibreglass, shoes containing rubber, shower caps, babies waterproof napkin covers and waterproof textiles should not be dried in the dryer. These materials can when heated produce fire by spontaneous combustion.
- When using STREAM REFRESH on unwashed clothing ensure there are no flammable substances on them.

SAFETY AND WARNINGS

Disposal

- Extreme care must be taken when disposing of your old appliance to avoid hazards.
- When disposing of the dryer, it is recommended that the door is removed to avoid children getting trapped inside, and that the electrical cable is cut off close to the dryer.

CONTROL PANEL

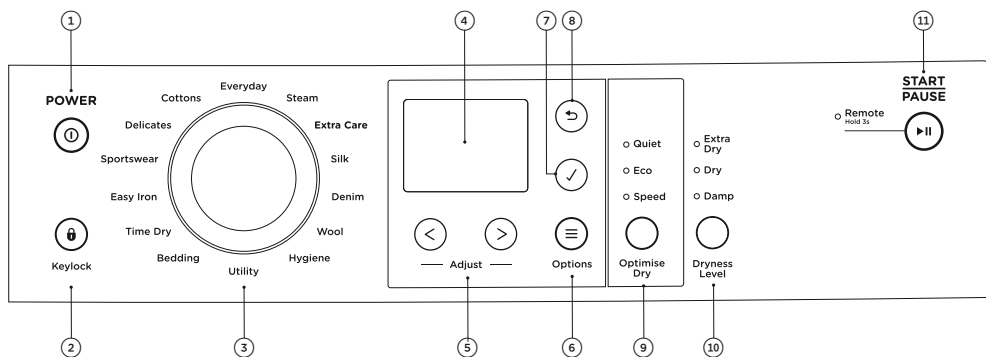

①	Power	Press to turn the dryer ON/OFF .
②	Keylock	Press to disable all buttons on the control panel, except the ① POWER button. This prevents accidental button presses.
③	SmartTouch™ Control Dial	Rotate to select your desired drying cycle. <ul style="list-style-type: none"> Red LED illuminates to indicate the selected dry cycle.
④	Digital display screen	Shows the following: <ul style="list-style-type: none"> Dry cycle icons and information based on dial selection. Dry cycle options and machine settings. Dry progress. Delayed start time of drying cycle. Notifications if an error is detected or a warning is necessary.
⑤	Adjust	Press to navigate through the dry cycles, dry cycle options and settings, and to increase or decrease the delay start time.
⑥	Options	Press to access dry cycle options and dryer settings.
⑦	Select	Press to accept the selected option or any changes made, and then return to the main screen.
⑧	Back	Press to exit current display and return to the main screen.
⑨	Optimise dry	Press to select SPEED, ECO or QUIET .
⑩	Dryness level	Press to select the level of dryness for your load.
⑪	Start/Pause	Press to start or pause the selected dry cycle. Hold for three seconds to enable REMOTE (WiFi) mode.

CONTROL PANEL

Timed cycles

When a timed cycle is selected the machine dries for the selected time regardless of the level of moisture in the load. It is important to check the items throughout the timed programmes to avoid over drying.

To adjust the length of timed cycles:

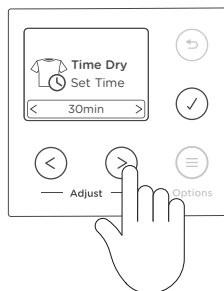

Select the desired cycle.

Use the **ADJUST** < > buttons to adjust the time up or down.

Press the ✓ button to confirm.

Dry progress

For all cycles, the display will show the phase of the cycle that is currently underway.

For timed cycles, the display will also show approximately how many minutes the cycle has remaining. For automatic cycles, the word **AUTO** will appear on the screen.

Keylock

To turn **KEYLOCK ON** or **OFF** when the dryer is powered **ON**:



Press  for three seconds.

When activated, the  is illuminated.

CONTROL PANEL

To turn your dryer on if **KEYLOCK** is **ON** and the dryer is powered **OFF**:



Press **POWER** ①, then press and hold **🔒** for three seconds. This will activate the control panel. Dry cycles and options can now be selected.

If a button is pressed while **KEYLOCK** is activated, beeps will be heard and **🔒** will flash.

If **KEYLOCK** is on and you want to pause your dryer:



To pause your dryer at any time during the cycle, press and hold **🔒** for three seconds then press **▶||**.

If **KEYLOCK** is **ON** and you want to power **OFF** your dryer at any time:



Press **POWER** ①.

WIFI CONNECTION & REMOTE MODE

Your appliance can be connected to your home wireless network and operated remotely using the app.

Getting started

- Ensure your home WiFi network is turned on.
- You will be given step by step guidance on both your appliance and mobile device.
- It may take up to 10 minutes to connect your appliance.

On your mobile device:

- ① Download the app from www.fisherpaykel.com/connect
- ② Register and create an account.
- ③ Add your appliance and set up the WiFi connection.

Connecting to your home WiFi

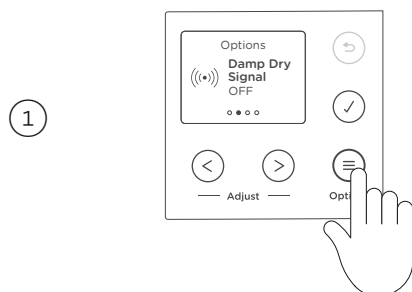

Press **OPTIONS** ≡, the screen will show the default option **DAMP DRY SIGNAL**.

Scroll to **SETTINGS** using the **ADJUST < >** buttons, press ✓ to confirm.

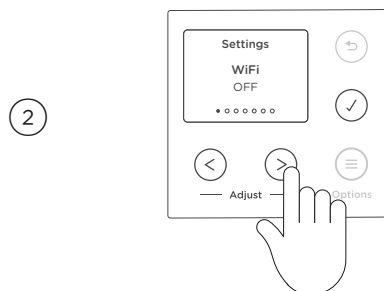

Press **ADJUST >** to scroll through the list of **SETTINGS** to **WiFi OFF**, press ✓ to select and edit.

Press **ADJUST <** or **>** to select **WiFi SETUP** and ✓ to confirm to start the setup process.

WIFI CONNECTION & REMOTE MODE

Enabling remote mode

1



Press and hold ▶|| for three seconds.

2

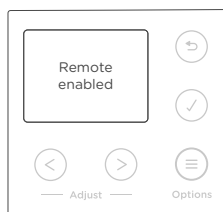

REMOTE ENABLED will appear in the display screen.

REMOTE MODE is now enabled. Certain functions of your washer can now be accessed via the app.

For safety reasons, **REMOTE MODE** cannot be enabled if the dryer door is open.

Disabling remote mode

1



Press and hold ▶|| for three seconds.

2

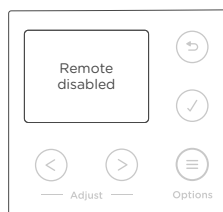

REMOTE DISABLED will appear in the display screen. **REMOTE MODE** is now disabled.

DRY CYCLES

Your dryer has a number of dry cycles to suit your laundering needs. Selecting the most appropriate cycle for each particular dry load will help ensure you get the best dry result.

CYCLE	SUB-CYCLE	DESIGNED FOR	MAX. LOAD SIZE (KG)	DEFAULT DRYNESS LEVEL
Everyday	Everyday	A high heat cycle designed for mixed loads.	9	Dry
	Heavy	A longer, high heat cycle for durable garments.	8	Dry Extra Dry
Cottons	Cotton ¹	A high heat cycle designed for cotton garments.	9	Dry
	Towels	A high heat cycle for drying towels.	6	Dry
Delicates	Delicate	A low heat cycle for careful drying of delicate and heat sensitive garments.	4	Dry
	Ultra Delicate	An extra low heat cycle for careful drying of ultra delicate and heat sensitive garments.	1	Dry
Sportswear	Activewear	An extra low heat cycle designed for special care of light synthetic garments.	2	Dry
	Sports	A medium heat cycle designed for sports garments.	4	Dry
	Outdoor	A low heat cycle for high performance fabrics and outdoor garments.	2	Dry
Easy Iron	n/a	A medium heat cycle that leaves garments ready to iron. WRINKLE FREE automatically selected.	4	Damp Dry
Time Dry	n/a	A cycle with user selectable drying times.	9	n/a
Bedding	Sheets	A high heat cycle with reversing to reduce tangling for large bedding items.	4	Dry Extra Dry
	Bulky	A low to medium heat cycle designed for careful drying of bulky items.	2	Dry Extra Dry
Utility	Rack Dry	A cycle with user selectable drying times that uses the drying rack for items that cannot be tumbled.	3	n/a
	Cool Air	40 minute cool air cycle.	4	n/a

DRY CYCLES

CYCLE	SUB-CYCLE	DESIGNED FOR	MAX. LOAD SIZE (KG)	DEFAULT DRYNESS LEVEL
Hygiene	n/a	A longer, high heat cycle designed to eliminate >99.9% of household bacteria.	4	Extra Dry
Wool ²	n/a	A low heat cycle designed for special care of washable woollen items that complies with Woolmark Apparel Care criteria.	1	n/a
Denim	n/a	A medium heat cycle designed for special care of stretch denim garments.	3	Dry
Silk	n/a	An extra low heat cycle designed for special care of silk garments.	1	Dry
Extra Care	Sneakers	Timed cycle to warm blow dry sneakers and sports shoes using the drying rack.	1-2 pairs	n/a
	Soft Toys	Timed cycle to warm blow dry soft toys. Do not dry toys with plastic, metallic or electrical parts.	1-4 items	n/a
Steam	Steam Freshen	A cycle for de-wrinkling and removing odours from dry garments.	1-2 items	Dry
	Pre Iron	A quick cycle for de-wrinkling dry garments before ironing.	1-2 items	Damp Dry

¹COTTON with ECO selected is the recommended energy saving cycle for everyday drying.

²Woolmark Apparel Care

The wool drying cycle of this machine has been approved by The Woolmark Company for the drying of machine washable wool products provided that the products are washed and dried according to the instructions on the garment label and those issued by the manufacturer of this machine. M2018.



DRY PREPARATION

Sorting

Sort items into loads of similar items, and loads that will likely take similar times to dry. This prevents the possibility of some items becoming over-dried whilst others are still damp.

Separate coloured items from white/light items where possible, especially when new. Colour run may be an issue, especially if you intend to delay the start of the drying cycle.

Care labels on garments provide valuable information about the fabric type and how the garment should be dried. Always follow the advice on garment labels.

ITEM/DRYING REQUIREMENTS	SUGGESTED CYCLE	COMMENTS
Towels	Towels	Towels produce a lot of lint and are best dried on their own.
Sheets, pillowcases	Sheets	Ensure openings are buttoned/domed before placing in the dryer.
Bulky items — doonas/duvets, sleeping bags and blankets	Bulky	Dry only one bulky item at a time.
Business shirts, trousers, other creasables	Easy Iron	WRINKLE FREE is automatically selected to help minimise creasing once the drying cycle has finished.
Woollens	Wool	Designed for machine washable woollen items.
Delicates, fine fabrics	Delicate, Ultra delicate or Rack Dry	You can further reduce the dryness level to damp or use Rack Dry for very delicate items.
Denim	Denim	Turn jeans inside out to help maintain their appearance. Dry separately from other items.
Sports and casual shoes	Sneakers	Check on the item regularly throughout the drying cycle. Ensure the rack has been correctly fitted.
Soft toys	Soft Toys	Check on the item/s regularly throughout the drying cycle. Use the drying rack for more delicate soft toys.
Hats and other odd shaped items	Rack Dry	Check on the item regularly throughout the drying cycle. Ensure the rack has been correctly fitted.
Jackets	Outdoor	Turn jackets inside out to help maintain their appearance. Dry separately from other items.
Bed linen, tea towels, socks, reusable face masks	Hygiene	Ensure the items can safely withstand heat.

DRY PREPARATION

Before you load

- Check pockets for items that could damage your clothes or get caught in the dryer.
- Close zippers, hooks and eyes, and other fastenings (ie fasten the openings of duvet/doona covers), and remove loose bra wires. These may damage both your dryer and your clothes.
- Items of clothing with screen-printing should be turned inside out to prevent damage to the print.
- Check the lint filter is clean and the water tank is empty (if the dryer is not set up to drain automatically).

Loading

- Garments need to be loaded correctly to minimise creasing and wrinkling, and to ensure the load is dried evenly.
- Allow enough room in the dryer for clothes to tumble freely. Load the dryer in terms of the space the garments take up when dry, rather than when they are wet.
- Shake clothes out and load individually to help items dry evenly and reduce tangling.
- Dry permanent press garments (business shirts) together on the **EASY IRON** cycle with the **WRINKLE FREE** option on. This will help reduce wrinkling and the need for ironing. Hang garments as soon as the drying cycle is complete to reduce the need for ironing.

Drying times

- Drying very small loads is inefficient. Try to dry medium to large loads.
- Heavier items (towels, flannelette sheets) will take longer to dry than light items (synthetics and polyester cotton sheets and shirts).
- Drying times can be reduced by spinning the wash load at the highest spin speed suitable for the load type in your washing machine.
- Check bulky items during the cycle to ensure even drying, pause the dryer and reposition the item if necessary.

Lint

Some items are lint givers, while others are lint collectors. Always dry lint givers and collectors separately.

LINT GIVERS	LINT COLLECTORS
Towels	Synthetics, eg polar fleece
Flannelette sheets	Corduroy
	Polyester cottons

Delicate or easily damaged items (eg nylon stockings, fine fabrics, delicate embroidered fabrics) should be dried separately, using the **DELICATE**, **ULTRA DELICATE**, **SILK** or **WOOL** cycle, or if you do not want them tumbled use the **RACK DRY** cycle. Sleeping bags and other down items should be dried on the **BULKY** cycle.

DRY PREPARATION

Drying rack

The drying rack is installed in your dryer when it leaves the factory. There are many items that would benefit from being dried on a drying rack. For example items such as hats, sneakers and delicate soft toys are items that may be damaged if they are tumbled.

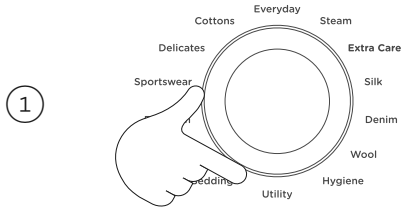

The drying rack is installed in your dryer when it leaves the factory.

When you are using the drying rack you must select an appropriate cycle: **RACK DRY, SNEAKERS or SOFT TOYS.**

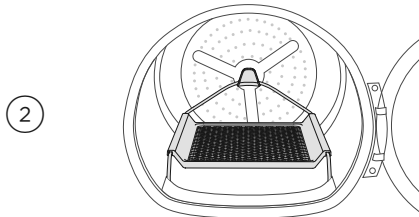

To remove the drying rack, detach the legs from the slots in the lint filter and gently remove from the drum.

GETTING STARTED QUICKLY

Check the lint and condenser filters are clean and replaced correctly before every load. Ensure the water tank is empty or drain hose secure before using your dryer.

Sort and load items into the dryer drum, ensuring no items are in the way of the door. Close the door (you will hear it click shut).

1



Press **POWER** **!** to activate your dryer.

2

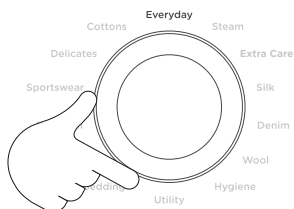

Select your desired drying cycle by turning the SmartTouch™ Control Dial.

A red LED will illuminate as you turn the dial showing which cycle is selected.

3



The screen will display the information specific to the selected cycle.

To select a sub-cycle use **ADJUST** **<** or **>** to scroll through the sub-cycles.

4



Once the dry cycle is selected, the screen will display **NO DELAY**, indicating the dry cycle is ready to start.

GETTING STARTED QUICKLY

4

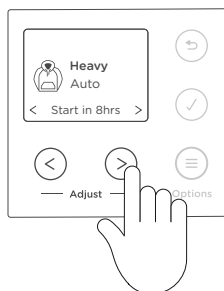

If you prefer to start the wash cycle at a later time, set a delay for the start time by using the **ADJUST** >.

5



Press ▶|| to start the cycle.

If you wish to change a cycle or select a different option once a drying cycle has started, press ▶|| then select the new cycle.

Press ▶|| to restart the dryer with the new cycle and/or settings.

When the cycle finishes, your dryer will beep and then turn off automatically. If the **WRINKLE FREE** option has been selected the dryer will rotate the drum periodically to help minimise wrinkling and creasing of your load.

If you wish to stop the dryer before the cycle has finished you **MUST** remove the clothes **IMMEDIATELY** and spread them out to cool. **DO NOT** leave the clothes in the dryer or bunched up in a clothes basket. Take extreme care as the drum and the load items may be extremely hot.

DRY CYCLE OPTIONS

Options

All dry cycles default to the recommended settings for that cycle based on the average expected load to be dried. You can adjust and customise the dry options to create your desired cycle.



WRINKLE FREE

At the end of the cycle, the drum will rotate periodically to minimise wrinkling and creasing. This is particularly useful if you cannot remove the items immediately after the cycle ends.

- **ON** provides **WRINKLE FREE** operation for one hour.
- **EXTRA** provides **WRINKLE FREE** operation for 24 hours.
- To remove the load during **WRINKLE FREE**, press **▶II**.

Options: OFF (Default), ON, EXTRA

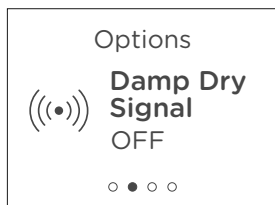

DAMP DRY SIGNAL

Your dryer will beep to alert you to remove items once your load reaches the damp stage. The dryer will beep to alert you to remove your items, then it will continue drying until the remaining load reaches the dryness level you selected.

- This option is not available if **BEEPS** have been set to **OFF** in the **SETTINGS**, refer to 'Dryer settings'.

Options: OFF (Default), ON

DRY CYCLE OPTIONS

To change a dry cycle option

1

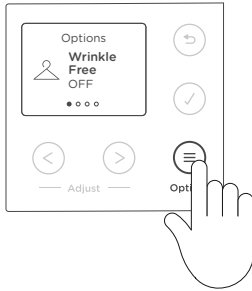

Press **OPTIONS** ≡, the screen will show the default dry cycle option.

2



Press **ADJUST** < or > to scroll through other options.

3

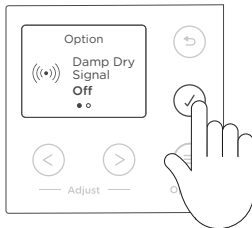

Press ✓ to select the option and enable editing.

4

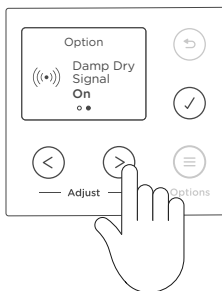

Press < or > to edit the selected option and then press ✓ to confirm.

CUSTOMISING A DRY CYCLE

Delay Start

You can delay the start of the dry cycle between 15 minutes and 12 hours. This can be useful to time your drying to finish when you arrive home from work.

1

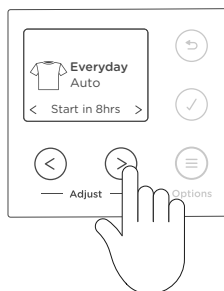

Press the **ADJUST** > button to increase the delay time, and < button to decrease the time, or turn **DELAY START** off.

2



Press ▶|| to confirm your selection and start the countdown. The display screen will show the time until the cycle is set to begin.

Avoid using **DELAY START** for damp, non-colourfast items as this may cause dye run to occur.

Dryness level

○ Extra Dry

● Dry

● Damp



Dryness Level

When your dryer senses that the clothes have dried to the dryness level selected, the dryer will automatically finish the cycle.

Two lights are used to show some dryness levels, eg to achieve the **DAMP DRY** setting both the **DRY** and the **DAMP** lights will be illuminated.

There are five dryness levels that can be selected from **DAMP** through to **EXTRA DRY**. You can alter the dryness level from the default to suit your load depending on how dry you want your items to be.

CUSTOMISING A DRY CYCLE

Optimise Dry

Your dryer offers you three optimise dry modes – **SPEED**, **ECO** and **QUIET**– allowing you to reduce noise, save energy or save time. Only one mode can be selected at a time. For clothes care reasons not all options are available on all cycles. These dry modes are available on **EVERYDAY**, **COTTONS**, **HEAVY** and **TOWELS** cycles.

Speed

A special feature designed to offer a shorter cycle whilst providing good dry performance. Please be aware that a number of factors can influence the amount of time saved on a cycle, including the load size, cycle chosen and load distribution.

Eco

Use the **ECO** option to save energy. Selecting **ECO** will reduce the drying temperature slightly.

Quiet

Use the **QUIET** modes when drying at night and/or when noise is a concern. This mode enables reduced fan speeds to reduce the level of noise emitted. When **QUIET** mode is selected the end of cycle signal (beeps) is disabled.

CUSTOMISING A DRY CYCLE

To set a favourite

After using your dryer a few times you may discover there are some options you prefer for some cycles. You can programme your dryer to remember the dry options you prefer for each cycle. For instance, you may want to set the **EVERYDAY** cycle to default to **EXTRA DRY** or set the **HEAVY** cycle to include **QUIET** or **SPEED**. There are two options for making a dry cycle **FAVOURITE**.

At the end of a cycle



The display will show the cycle used and the status as complete with the question **SAVE AS FAVOURITE?**



To accept, press ✓.

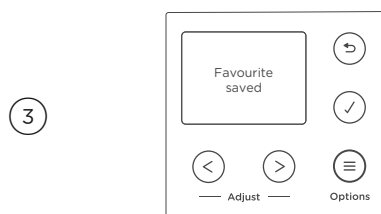

The display will show the setting has been saved. The cycle will now appear with a ♥ icon.

CUSTOMISING A DRY CYCLE

From options

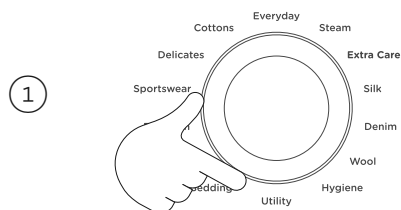

Select the cycle using the control dial.

Select the start time (**NO DELAY** or **DELAY START** time) of your choice.

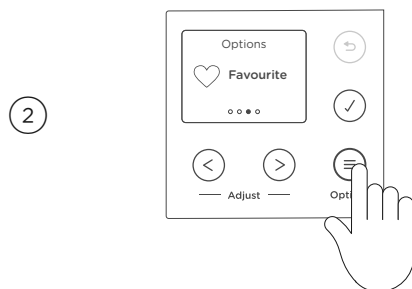

Scroll through **OPTIONS** ≡ using **ADJUST** < or > and select **FAVOURITE**. Press ✓ to edit.

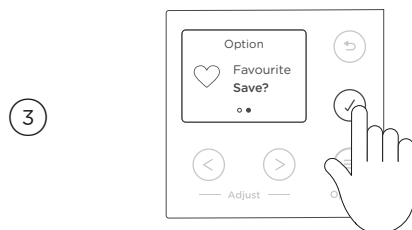

Select **SAVE** and press ✓ to confirm.

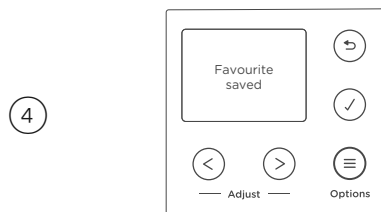

The display will show the setting has been saved. The cycle will now show ♥ icon to show cycle has been saved as a favourite.

Favourites can be removed by either choosing **REMOVE FAVOURITE** within the **FAVOURITES OPTIONS** menu or using **RESET DEFAULT** in the **SETTINGS** menu. Selecting **RESET DEFAULTS** will reset all **FAVOURITES** and any other saved settings, such as WiFi details, back to the factory default settings.

DRYER SETTINGS

Settings

WiFi

OFF



WiFi

Allows WiFi Setup and indicates if WiFi is **ON/OFF**.

Settings: ON, OFF (Default), **SETUP**

Settings

Cycle Information

ON



Cycle information

Displays details of what the cycles are designed for.

Settings: ON (Default), **OFF**

Settings

Beeps

ON



Beeps

Turns on/off sounds.

- The sound when touching the buttons.
- The series of beeps that sound at the end of a cycle to alert you that the dryer has finished.

Settings: ON (Default), **OFF**

Settings

Screen Brightness

MEDIUM



Screen brightness

Adjusts the brightness of the digital display screen.

Settings: LOW, **MEDIUM** (Default), **HIGH**

Settings

Drum Light

AUTO



Drum light

Turns on/off drum light.

- LED light turns on when the washer is powered and turns off automatically.
- Turns on again at the end of the cycle to help facilitate unloading.

Settings: AUTO (Default), **OFF**

DRYER SETTINGS



User prompts

Turns on/off the user-prompts that are not related to warnings or faults.

Settings: ON (Default), OFF

Editing settings

Dryer **SETTINGS** within **OPTIONS** can be used to adjust default settings to your preference for beeps, drum light, screen brightness, user prompts and factory reset.

To change a setting

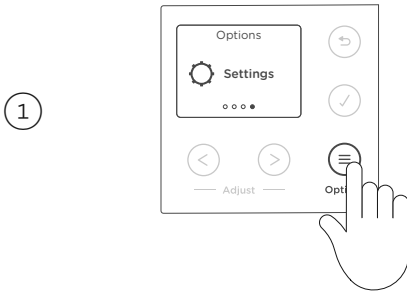

Press **OPTIONS** ≡, scroll to **SETTINGS** using the **ADJUST** < > buttons, press ✓ to confirm.

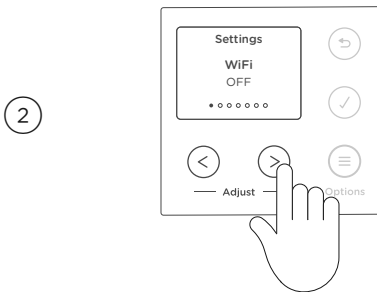

Press **ADJUST** < or > to scroll through the list of **SETTINGS**, press ✓ to select and edit.

Press **ADJUST** < or > to select and press ✓ to confirm.

Selecting **RESET DEFAULTS** will reset all **FAVOURITES** and any other saved settings, such as WiFi details, back to the factory default settings.

CARING FOR YOUR DRYER

When you have finished using your dryer

- Unplug the dryer from the power socket.
- Wipe around the door to remove any remaining condensation and foreign matter.
- Clear the lint and condenser filters and empty the water tank (if not set up to automatically drain).

Cleaning the control panel and outer surfaces of the dryer

Use a soft damp cloth to wipe all surfaces, then wipe dry. Avoid using chemical or scouring cleaners, as these will damage the paint and plastic surfaces of your dryer.

Cleaning the inside of your dryer

It is important to occasionally clean the inside of your dryer. If the drum has any residual dirt or lint stuck to it, remove this and wipe it clean with a damp cloth. Do not leave any metal objects in the drum, as these may cause rust.

Cleaning the filters

Cleaning the door lint filter

Lint is generally formed during wearing and washing. Fibres (ie lint) released from the clothes during the drying cycle are collected in the lint filter.

It is important to clean the door lint filter after every load, as the lint produced in the drying process can become a fire hazard if it is allowed to accumulate in or around your dryer.

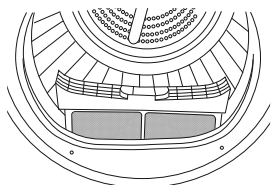

The door lint filter is located in the door opening (at the bottom).

CARING FOR YOUR DRYER

To clean the door lint filter:

①

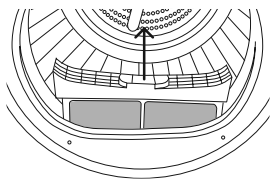

Open the dryer door.

Remove the lint filter by pulling it up and out of the filter slot.

②

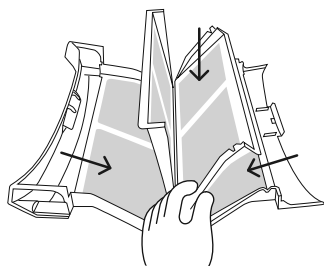

Open it out and wipe the surfaces clean with your hand or a soft cloth.

Close the lint filter and place it back in the opening. Ensure the filter is fitted correctly back in place before operating the dryer.

Cleaning the condenser filter, foam and evaporator grid

To maintain optimum performance of your dryer the condenser filter, foam and evaporator grid must be cleaned.

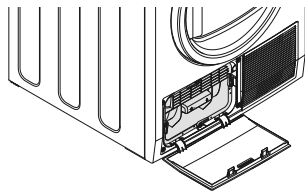

Condenser filter

The condenser filter is located below the door on the left-hand side.

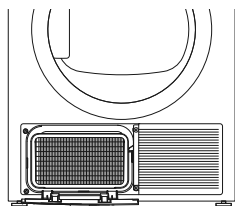

Evaporator grid

The evaporator grid is located behind the condenser filter.

CARING FOR YOUR DRYER

To clean the condenser filter:

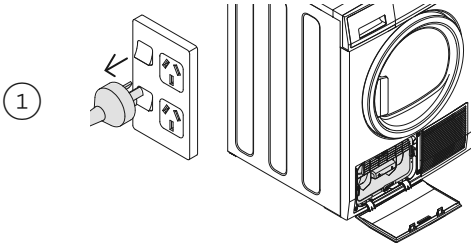

Switch off the power supply and remove the power plug.

Open the condenser filter cover.

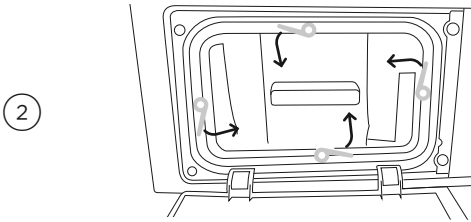

Turn the four condenser lock levers 90° then pull out the condenser filter.

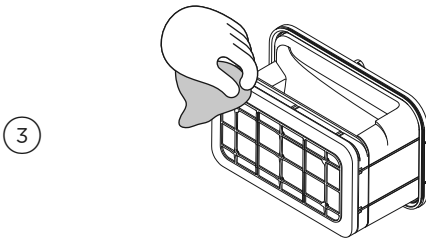

Use your hand, a cloth or a vacuum with a crevice nozzle to remove any lint build-up from the mesh surface of the filter.

CARING FOR YOUR DRYER

To clean the filter foam:

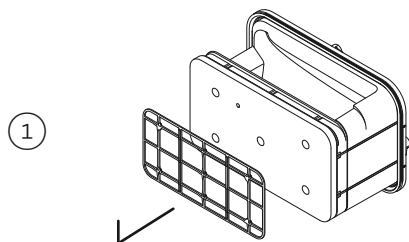

Remove the bracket securing the foam to condenser filter.

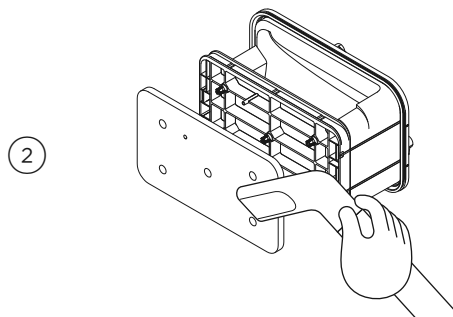

Remove the foam and vacuum lint build-up with a crevice nozzle.

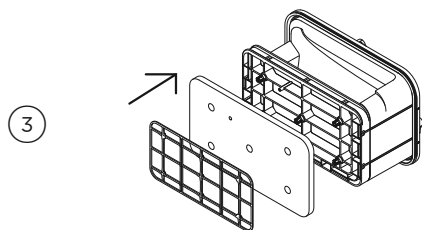

Replace the filter foam and secure with the bracket.

The condenser filter foam should be replaced regularly, three filter foams are provided with your dryer. Further replacement filter foam can be purchased from Fisher&Paykel.com or from your Fisher & Paykel trained and supported service technician.

CARING FOR YOUR DRYER

To clean the evaporator grid:

With the condenser filter removed you will be able to see the evaporator grid.

Cut Hazard. The surface of the evaporator has sharp edges and contact may result in injury. Handle with care when cleaning the grid and always keep blades away from fingers and body.

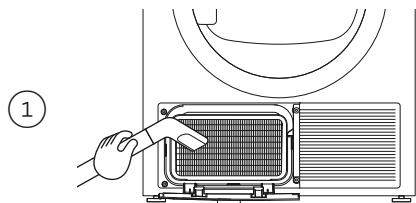

If the surface of the evaporator grid is dirty, clean it carefully with a vacuum cleaner using a dusting brush or a narrow crevice tool. Be gentle and do not bend the fine metal fins.

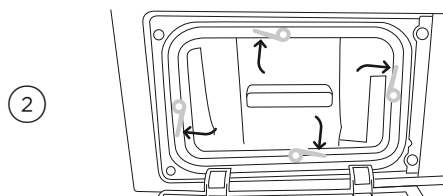

Replace the condenser filter.

Turn the four condenser filter lock levers to lock the condenser filter back in place. Ensure the locks are engaged securely.

Close the condenser filter cover.

CARING FOR YOUR DRYER

Cleaning the sensors

There are sensors in your dryer that detect whether the laundry is dry or not. These sensors need to be cleaned periodically (we recommend approximately four times a year).

To clean the sensor:

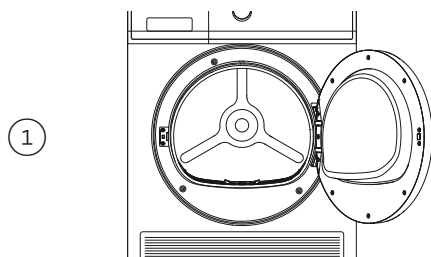

Open the door of your dryer. Allow the dryer to cool if drying has been carried out.

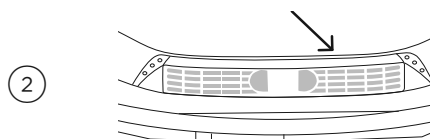

Locate the metal sensors just behind the lint filter.

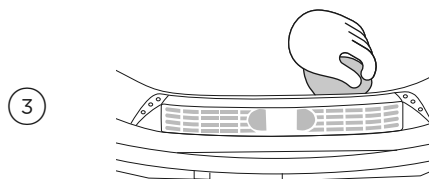

Wipe the sensors with a soft cloth, dampened with vinegar and dry with a clean dry soft cloth.

CARING FOR YOUR DRYER

Emptying the water collection tank

During the drying cycle, steam condenses into water and is collected in the water tank, located at the top left of the dryer. It is important to empty the water tank after every load.

If the water tank becomes full during operation, the dryer will pause, display a user prompt and beep to alert you.

To empty the water tank:

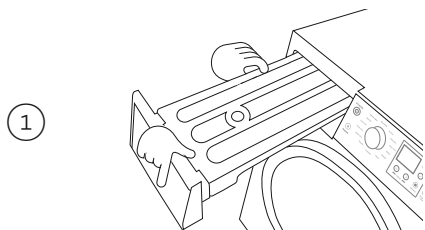

Remove the water tank by holding onto the handle and pulling outwards gently. Ensure the tank is kept level when removed to prevent the water from spilling.

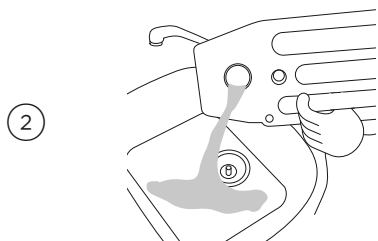

Pour the water down the sink or into a bucket, and then put the tank back in place.

Never run the dryer without the water tank in place unless the drain hose has been installed.



You do not need to empty the water tank if you have set up the drain hose to drain the water automatically.

BEFORE YOU CALL FOR SERVICE

User warnings

Your dryer is capable of diagnosing a number of its own problems. It will sound a continuous series of beeps and display a user prompt when it has a problem that you can correct yourself. To stop the beeps sounding, touch any button on the control panel. Do not try to continue your drying cycle once you stop the noise. You must address the problem the dryer is alerting you to.

Check the below table before you call for service.

NOTIFICATION	WHAT TO DO
KEYLOCK ON	Touch and hold the  button for three seconds to deactivate the Keylock.
CLEAN FILTERS AND EVAPORATOR GRID	Clean lint and condenser filters and carefully vacuum the evaporator grid. Check the lint filter or condenser filter are not damaged. Check there is nothing else trapped in the filters or evaporator grid, which may be blocking the air flow. Check the filters are correctly in place in your dryer.
WATER TANK	Check if the water tank is full. Empty the water tank. If using the drain hose, check whether the water tank or drain hose is blocked. Check the drain hose is still attached at the back of the machine, and is not kinked or squashed.
DOOR OPEN	Close the door fully and touch  II. Try opening and closing the door again. Reposition the load, make sure the load is correctly in the drum and that protruding items are not preventing the door from closing.
THE LAUNDRY ENVIRONMENT IS TOO COLD FOR THE DRYER TO FUNCTION	The room temperature is too low for the heat pump system to work effectively. Ensure that the room temperature is above five degrees to avoid loss of efficiency.
MAXIMUM CYCLE TIME HAS BEEN REACHED	There are a number of reasons the maximum cycle time has been reached, refer to 'Troubleshooting', 'Dryer is taking too long.' for possible causes and solutions.

Once you have addressed the issue the user prompt was alerting you to, try using your dryer as per usual. If the issue persists, call your Fisher & Paykel trained and supported service technician.

FAULT CODES

When a continuous series of beeps sound, all the lights turn off on the control panel and a number appears on the display, a fault has occurred. The dryer will automatically enter this mode if a fault occurs. The word **FAULT** will be shown in the control panel display followed by a number. To stop the beeps, press any button then perform the following steps:

- ① Turn your dryer off at the power point.
- ② Wait one minute and turn it back on.
- ③ Check your dryer is installed correctly, refer to your separate installation guide.
- ④ Remove your load from the dryer and retry.
- ⑤ Perform a **TIME DRY** cycle, eg **TIME DRY** for 30 minutes.
- ⑥ If the fault re-occurs repeat steps ① and ②.
- ⑦ If the dryer still will not work call a Fisher & Paykel trained and supported service technician to arrange service, refer to 'Before you call for service'. Record the fault code number displayed and the serial number of your dryer (located on the rear of the dryer, or on the inside of the door below the glass) before calling. The fault code will indicate to the service technician what the problem could potentially be.

If a fault code is being displayed, you can still turn your dryer off by pressing **POWER** ①.

TROUBLESHOOTING

The following is a list of problems you may encounter when using this appliance and some suggestions that may help to correct the problem. If you still have problems, contact your Fisher & Paykel trained and supported service technician.

PROBLEM	POSSIBLE CAUSES	WHAT TO DO
Pressing POWER ① does not turn on the dryer	Fault with household power supply.	Try plugging in and turning on another electrical device.
Dryer does not heat	Full water tank.	Refer to 'Emptying the water collection tank'.
	The dryer has progressed to COOL .	Check the progress lights - are COOL or END lights illuminated? Refer to 'Control panel'.
Pressing ►II does not start the drying cycle	Dryer door not closed properly.	Open and close the door. Check that the lint filter is correctly in place and not obstructing the door.
	Is the dryer displaying a user warning or fault code?	Refer to 'User warnings' and 'Customising a dry cycle'.
	Water tank full or not properly in place.	Refer to 'Emptying the water collection tank'. Ensure the water tank is properly in place.
	Dryer is overloaded.	Remove some items from the dryer.
	DELAY START function is set.	Refer to 'Delay Start' for more information.
	KEYLOCK is ON.	To disable press 🔒 for three seconds.
Dryer keeps stopping and starting	The WRINKLE FREE option has been selected.	Refer to 'User warnings' for more information.
Dryer stops working mid-cycle	Power failure.	Press POWER ① and restart the desired cycle.
	Dryer has been paused.	Press ►II to restart the cycle.
	Dryer door is open.	Ensure the door is firmly shut.
	Items fell off the rack when using RACK DRY cycles.	Ensure the rack is installed correctly (refer to 'Drying rack') and replace garments that may have fallen from it.

TROUBLESHOOTING

PROBLEM	POSSIBLE CAUSES	WHAT TO DO
<p>Dryer is taking too long.</p> <p>Results were not satisfactory.</p>	Drying cycle selected not appropriate for the load.	Select an appropriate cycle for the load. Refer to 'Drying rack'.
	Dryness level selected not appropriate for the load.	Select a higher dryness level. Refer to 'Lint'.
	Dryer overloaded for the cycle.	Some cycles have a lower max load size. Refer to 'Drying rack'.
		Try dividing the load in half and dry half at a time.
	Lint filter, condenser filter, filter foam or evaporator grid is blocked.	Clean the lint filter, condenser filter, filter foam and evaporator grid. If the problem continues the foam filter may need to be replaced, refer to 'Clean the filter foam'.
	Water tank is full.	Refer to 'Emptying the water collection tank'.
	Environmental conditions may be affecting dryer operation.	In particularly hot or cold conditions the dryer will take longer to dry a load and be less efficient. Ensure the dryer is installed in a well-ventilated, dust-free environment. Do not operate this dryer behind closed doors (ie inside a cupboard).
	Load overly wet at the start of cycle.	Remove more water from the load before placing it in the dryer, eg select a faster spin speed on your washer, if appropriate for your load.
Load was damp dry at the start of cycle.	If the load had been partially air dried, eg has been washed and placed on the line, use a TIME DRY cycle and monitor the dryness of your clothes.	
Dryer not draining water out properly.	Check the drain hose (if connected) for blockages or damage. You may need to call for service refer to 'Before you call for service'.	
Items got tangled.	Try separating items and drying similar items together. Refer to 'Loading' for further tips.	

TROUBLESHOOTING

PROBLEM	POSSIBLE CAUSES	WHAT TO DO
Dryer is not draining	Drain hose not connected to the water tank.	Ensure the drain hose is connected correctly. Refer to your installation guide for guidance on draining.
	Water tank not in place correctly.	Ensure water tank is properly in place.
	Drain hose or drain blocked or damaged.	Check drain hose (if connected) and drain for blockages or damage.
Clothes getting too hot or damaged	Cycle selected not appropriate for the load.	Ensure the cycle selected is appropriate for items in the load. Refer to 'Drying rack'.
	Items removed from dryer before the end of cycle cool down had finished.	Removing items before cool down may damage clothing if it is not spread out and exposed to air to cool once removed from the dryer.
Dryer is beeping and displaying a code on the digital display	Dryer has a fault.	Try turning the dryer off and waiting one minute before turning it back on. Refer to 'Customising a dry cycle'.
Small puddle of water coming from under the dryer	Water tank not correctly in place.	Ensure the water tank is correctly in place.
	Water tank may need to be emptied.	Refer to 'Emptying the water collection tank'.
	Water tank may be damaged.	Check the water tank for any signs of damage.
	Drain hose may not be attached properly at the dryer end.	Ensure the drain hose is attached properly. Refer to your installation guide for guidance on draining.
	Drain hose could be damaged.	Check the drain hose for damage.
	Drain hose has slipped out of the drain.	Ensure the drain hose is securely fixed in place. Sometimes drain hoses can move or get displaced, which may lead to water draining onto the floor.
	Drain may be blocked.	Check the drain for any blockages.
	Dryer door not closing properly, affecting the seal.	Ensure the dryer door is closed properly and there is nothing obstructing the door opening.
	Inlet hose not correctly tightened.	Check inlet hose and tighten connection if necessary.

TROUBLESHOOTING

PROBLEM	POSSIBLE CAUSES	WHAT TO DO
Small amount of water in the drum at end of cycle	Water tank needs to be emptied.	Refer to 'Emptying the water collection tank'.
	Environmental conditions may be affecting dryer operation.	If conditions are particularly hot, humid or cold, it is possible vaporised water may re-condense in the drum or on the inside of the door.
Noises	Dryer is overloaded.	Remove some items from the dryer.
	Dryer has a fault.	Continuous beeping or a musical series of beeps with a message displayed on the display. Refer to 'Customising a dry cycle'.
	Beeps signalling the end of a drying cycle.	End of cycle beeps can be turned off. Refer to 'Dryer settings'.
	Dryer has not been levelled properly.	Refer to your installation guide for guidance on levelling.
	Dryer makes unfamiliar noises.	At the start of the cycle the dryer may make some unfamiliar noises when the compressor turns on. This is normal.
Vibration	Dryer is not installed on a stable surface.	Ensure the dryer is installed on a flat, stable surface. Refer to your installation guide for guidance on levelling.
	Dryer is not level.	Ensure the dryer is correctly levelled. Refer to your installation guide for guidance on levelling.
	Dryer is overloaded.	Remove some items from the dryer.
Creasing	Cycle selection not appropriate for the load.	Select the EASY IRON cycle to minimise creasing.
	Dryer is overloaded.	Remove some items from the dryer.
	DRYNESS LEVEL selected too high for load type.	Try selecting a lower DRYNESS LEVEL .
	WRINKLE FREE option not selected.	Select the WRINKLE FREE option to rotate the load at the end of the drying cycle. Refer to 'User warnings'.
Dye transfer	White/light and coloured items not separated before drying.	Remember to separate white/light and coloured items before placing them in the dryer.
	Wet items left sitting in the dryer for long periods of time before drying.	Refer to 'Sorting' for tips to prevent dye transfer.

TROUBLESHOOTING

PROBLEM	POSSIBLE CAUSES	WHAT TO DO
Linting	Lint filter not cleaned or replaced.	Ensure the lint filter is cleaned after every cycle and replaced correctly. Refer to 'Cleaning the filters'.
	Loads not sorted correctly.	Dry lint-giving items separately from lint receivers. Also, dry similar colours together, eg light coloured items with light coloured items, dark items with dark items. Refer to 'Sorting', 'Lint'.
	Clothes over dried.	Over drying clothes in the dryer can cause them to attract lint. Use an auto sensing cycle or ensure you check your load if using the time dry cycles to avoid over drying. Refer to 'Drying rack'.
	New items have been dried in the dryer recently.	Clean the lint filter and use COOL AIR cycle to clear any remaining lint from the dryer.
	New towels or flannelette sheets can leave lint in the dryer, which may be picked up by subsequent loads.	
Fabric damage	Instructions on care label not followed.	Follow the instructions on the care label of the items.
	DRYNESS LEVEL selected not appropriate for the fabric type.	Ensure the DRYNESS LEVEL selected is appropriate for the fabric type. Refer to the items care label. Refer to 'Drying rack'.
	Metal parts on the items or in the load.	Fasten zips and other clasps before placing items in the dryer.
	Items not separated or dried on an appropriate cycle for the fabric type.	Dry similar items together. Ensure an appropriate cycle is selected. Refer to 'Drying rack'.
	Items fell off the rack when using RACK DRY .	Ensure the rack is installed correctly (refer to 'Sorting', 'Drying rack') and only one or two garments are placed on the rack at a time.
	Used a TIME DRY cycle and did not monitor the dryness of clothes during the cycle.	Ensure that clothes are checked for dryness during the cycle when using the timed programmes to avoid over drying.

TROUBLESHOOTING

PROBLEM	POSSIBLE CAUSES	WHAT TO DO
Tangling	Loads not separated during loading.	Try separating out larger items from smaller items.
	Items loaded into the dryer incorrectly.	Load items individually into the dryer. Do not place folded items in the dryer.
	Incorrect cycle selection.	Try using the EASY IRON cycle to dry shirts and the SHEETS cycle to dry sheets. Refer to 'Drying rack'.
	Load size too large.	Try drying smaller load sizes. Some cycles have a lower maximum load size. Refer to 'Drying rack'.
	Delicate items not dried on RACK DRY .	Dry pantyhose, bras, stockings and any other delicate items prone to tangling on the RACK DRY cycle.
	Sheets and duvet/doona covers due to their size, are prone to tangling.	Dry sheets and duvet/doona covers separately from other laundry, apart from towels. Ensure duvet/doona covers are buttoned or fastened closed before drying. Try adding a knotted towel to sheets loads if you are experiencing a lot of tangling.

MANUFACTURER'S WARRANTY

For New Zealand and Australia only. You automatically receive a 2 year Manufacturer's Warranty with the purchase of this heat pump clothes dryer covering parts and labour for servicing within the country of purchase.

Fisher & Paykel undertakes to:

Repair or, at its option, replace without cost to the owner either for material or labour any part of the product, the serial number of which appears on the product, which is found to be defective within TWO YEARS of the date of purchase.

Note: This Manufacturer's Warranty is an extra benefit and does not affect your legal rights.

This Manufacturer's Warranty DOES NOT cover

- Ⓐ Service calls which are not related to any defect in the product. The cost of a service call will be charged if the problem is not found to be a product fault.
For example:
 - ① Correcting the installation of the product.
 - ② Instructing you how to use the product.
 - ③ Replacing house fuses or correcting house wiring or plumbing.
 - ④ Correcting fault(s) caused by the user.
 - ⑤ Noise or vibration that is considered normal, eg drain/fan sounds, machine noises or user warning beeps.
 - ⑥ Correcting damage caused by pests, eg rats, cockroaches, etc.
 - ⑦ Poor drying performance due to incorrect installation and maintenance eg blocked lint filter, blocked condenser or full water tank.
 - ⑧ Poor drying performance due to incorrect loading, eg overloading or underloading.
 - ⑨ Damage from articles in the drum, eg bra wires, pens, crayons, dye transfer or flammable material.
- Ⓑ Defects caused by factors other than:
 - ① Normal domestic use; or
 - ② Use in accordance with the product's User guide.
- Ⓒ Defects to the product caused by accident, neglect, misuse or 'act of God'.
- Ⓓ The cost of repairs carried out other than by a Fisher & Paykel trained and supported service technician or the cost of correcting such repairs.
- Ⓔ Normal recommended maintenance as set out in the product's User guide.
- Ⓕ Repairs when the appliance has been dismantled, repaired or serviced by other than a Fisher & Paykel trained and supported service technician or the selling dealer.
- Ⓖ Pick-up and delivery.
- Ⓖ Transportation or travelling costs involved in the repair when the product is installed outside the Fisher & Paykel trained and supported service technician's normal service area.

Nothing in this Manufacturer's Warranty is intended to, or does, limit any rights you may have under law to recover the costs of inspecting or returning the goods to us.

MANUFACTURER'S WARRANTY

This product has been designed for use in a normal domestic (residential) environment. This product is not designed for commercial use (whatsoever). Any commercial use by a customer will affect this product's Manufacturer's Warranty.

Service under this Manufacturer's Warranty must be provided by a Fisher & Paykel trained and supported service technician (refer to the 'Before you call for service'). Such service shall be provided during normal business hours. This Manufacturer's Warranty certificate should be shown when making any claim.

For Australian Customers

This Manufacturer's Warranty is an extra benefit and does not affect your legal rights. Our goods come with guarantees that cannot be excluded under the Australian Consumer Law. You are entitled to a replacement or refund for a major failure and for compensation for any other reasonably foreseeable loss or damage. You are also entitled to have the goods repaired or replaced if the goods fail to be of acceptable quality and the failure does not amount to a major failure.

Please keep this user guide in a safe place.

CUSTOMER CARE

Before you call for service or assistance

Check the things you can do yourself. Refer to your User guide and check:

- ① Your product is correctly installed.
- ② You are familiar with its normal operation.
- ③ You have read the 'Customising a dry cycle', 'Customising a dry cycle' and 'Troubleshooting' sections.

If after checking these points you still need assistance or parts, please refer to your nearest Fisher & Paykel trained and supported service technician, Customer Care, or contact us through our website fisherpaykel.com.

In New Zealand if you need assistance*

Call the Fisher & Paykel Customer Care Centre and talk to one of our Customer Care Consultants.

Toll Free: 0800 FP CARE or 0800 372 273

Fax: (09) 273 0656

Website: fisherpaykel.com

Postal address: Fisher & Paykel Appliances Ltd, PO Box 58550, Botany, Auckland 2163

If you need service*

Fisher & Paykel has a network of Fisher & Paykel trained and supported service technicians that can carry out any service necessary on your appliance. Our Customer Care Centre can recommend a Fisher & Paykel trained and supported service technician in your area.

In Australia if you need assistance*

Call the Fisher & Paykel Customer Care Centre and talk to one of our Customer Care Consultants.

Toll Free: 1300 650 590

Fax: (07) 3826 9298

Website: fisherpaykel.com

Postal address: Fisher & Paykel Appliances Australia Pty Ltd, PO Box 798, Cleveland QLD 4163

If you need service*

Fisher & Paykel has a network of Fisher & Paykel trained and supported service technicians that can carry out any service necessary on your appliance. Our Customer Care Centre can recommend a Fisher & Paykel trained and supported service technician in your area.

*If you call, write or contact us via our website please provide: your name and address, model number, serial number, date of purchase and a complete description of the problem. This information is needed in order to better respond to your request for assistance.

Product details can be found on the rear of the dryer, and/or on the inside of the door below the glass (when the door is open).

CUSTOMER CARE

Registration

Register your product with us so we can provide you with the best service possible.
To register your product visit our website: fisherpaykel.com/register

Complete and keep for safe reference:

Model	_____
Serial No.	_____
Purchase Date	_____
Purchaser	_____
Dealer	_____
Suburb	_____
Town	_____
Country	_____

FISHERPAYKEL.COM

© Fisher & Paykel Appliances 2020. All rights reserved.

The models shown in this guide may not be available in all markets
and are subject to change at any time.

The product specifications in this guide apply to the specific products and
models described at the date of issue. Under our policy of continuous product
improvement, these specifications may change at any time.

For current details about model and specification availability in your country,
please go to our website or contact your local Fisher & Paykel dealer.

428277A 12.20