

Series 9, Integrated Single DishDrawer Dishwasher

Series 9 | Integrated

Panel Ready



Integrating into your kitchen design seamlessly, each drawer fits a half load that you can load and wash independently.

- Knock to pause function is perfect if you miss a dish
- Six wash programs, as well as additional Quick wash, Sanitise and Extra Dry options
- Flexible racking can be folded down to fit bigger dishes
- Customise with your own front panel and handle to match your kitchen cabinetry, or choose our stainless steel panel

DIMENSIONS

Height	410 mm
Width	599 mm
Depth	553 mm

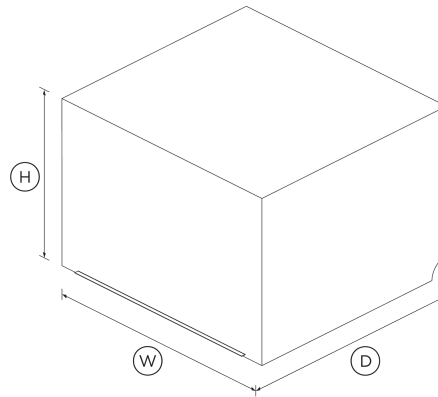

FEATURES & BENEFITS

Seamless Integration

Slide your DishDrawer™ Dishwasher into an existing kitchen space or integrate into kitchen cabinetry, for a seamless look whilst delivering superior dish care.

Ease Of Use

DishDrawer™ Dishwashers are as easy to open and close as kitchen drawers, making loading dishes simple. Flexible racking allows you to make adjustments to fit in a variety of dishes.

Quick, Sanitise And Extra Dry Options

The Quick wash modifier delivers a faster wash while maintaining performance. The Sanitise option provides extra protection killing 99.9% of bacteria in the final rinse. The Extra Dry setting is perfect for plastic dishes.

KNOCK TO PAUSE

These DishDrawer™ Dishwashers have a knock to pause function. A knock on the front panel will pause the dishwasher which can be re-started again by using the start/play button.

Quiet Performer

Running at a very low decibel rate, these DishDrawer™ Dishwashers do their job without making a fuss. The combination of intelligent technology and simple mechanics means greater reliability and excellent wash performance.

SPECIFICATIONS

Accessories (included)

- Cutlery basket
- Knife clip and multipurpose clip

Accessories (sold separately)

Door panel black stainless steel	ADDD60SPB
Door panel stainless steel	ADDD60SPX
Handle kit Contemporary round, aluminium	AHS-OBDD-60S

Handle kit Contemporary square fine, aluminium	AHD5-OBDD-60SX
Handle kit Contemporary square fine, black	AHD5-OBDD-60SB
Handle kit Contemporary square, aluminium	AHD3-OBDD-60S
Handle kit Contemporary square, black	AHD3-OBDD-60B

Capacity and loading

Accommodates round plates up to	280mm
Adjustable height, foldable cupracks	•
Fold down tines	•
Pitch adjustable tines	•
Place settings	6

Consumption

Energy rating	F
Energy usage	61kWh/100 cycles
Water usage (per wash cycle)	7.9L

Controls

Electronic fault/Diagnostic indicator	•
End of cycle beeps	•
Energy saving delay start option of up to 12 hours	•
Internal wash selector	•
Keylock	•
Knock to pause	•
Rinse aid indicator light	•
Smart appliance	•

Features

Built-in water softener	•
Fan assisted drying	•
Flood protection	•
Flow through detergent dispenser	•
Quiet operation	•
SmartDrive™ technology	•

Performance

Noise emissions	42 dBA
-----------------	---------------

Power requirements

Amperage	5A
Supply frequency	50Hz
Supply voltage	220 - 240V

Product dimensions

Depth	553 mm
Height	410 mm
Width	599 mm

Warranty

Parts and labour	2 years
------------------	----------------

Wash Program Modifiers

Extra Dry	•
-----------	---

Quick	•
Sanitise	•
Wash modifiers	3

Wash Programs

Delicate	•
Eco	•
Fast	•
Heavy	•
Medium	•
Rinse	•
Wash programs	6

Water connection

Water pressure	100kPa - 1000kPa
Water supply	3/4" BSP (20mm) Connector Water Inlet Hose

SKU	82362
-----	--------------

The product dimensions and specifications in this page apply to the specific product and model. Under our policy of continuous improvement, these dimensions and specifications may change at any time. You should therefore check with Fisher & Paykel's Customer Care Centre to ensure this page correctly describes the model currently available. © Fisher & Paykel Appliances Ltd 2020

Other product downloads available at fisherpaykel.com

- [↓ 2D-DWG Integrated Single DishDrawer™ Dishwasher](#)
- [↓ 2D-DXF Integrated Single DishDrawer™ Dishwasher](#)
- [↓ Data Sheet Integrated Single DishDrawer™ Dishwasher](#)
- [↓ Energy Rating](#)
- [↓ Energy Label](#)
- [↓ Service & Warranty](#)
- [↓ Installationsvejledning DA](#)
- [↓ Installationsanleitung DE](#)
- [↓ Installatie gids DUT](#)
- [↓ Installation Guide Single DishDrawer™ Dishwasher](#)
- [↓ Guía de instalación ES](#)
- [↓ Asennusopas FI](#)
- [↓ Guide d'installation FR](#)
- [↓ 安装说明书 HE](#)
- [↓ Guida D'Installazione IT](#)
- [↓ Installasjonsveiledning NO](#)
- [↓ Guía de instalación ES](#)
- [↓ Installationsguide SV](#)
- [↓ Quick Start Guide DishDrawer™ Dishwasher DA](#)
- [↓ Quick Start Guide](#)
- [↓ Quick Start Guide DishDrawer™ Dishwasher DEU](#)
- [↓ Quick Start Guide DishDrawer™ Dishwasher DUT](#)
- [↓ Quick Start Guide DishDrawer™ Dishwasher DUT](#)
- [↓ Quick Start Guide DishDrawer™ Dishwasher ES](#)
- [↓ Quick Start Guide DishDrawer™ Dishwasher ES](#)
- [↓ Quick Start Guide DishDrawer™ Dishwasher FIN](#)
- [↓ Quick Start Guide DishDrawer™ Dishwasher FIN](#)
- [↓ Quick Start Guide DishDrawer™ Dishwasher FR](#)
- [↓ Quick Start Guide DishDrawer™ Dishwasher HEB](#)
- [↓ Quick Start Guide DishDrawer™ Dishwasher HEB](#)
- [↓ Quick Start Guide DishDrawer™ Dishwasher ITA](#)
- [↓ Quick Start Guide DishDrawer™ Dishwasher ITA](#)
- [↓ Quick Start Guide DishDrawer™ Dishwasher NOR](#)
- [↓ Quick Start Guide DishDrawer™ Dishwasher SWE](#)
- [↓ Revit Integrated Single DishDrawer™ Dishwasher](#)

- [↓ Rhino Integrated Single DishDrawer™ Dishwasher](#)
- [↓ Rhino Integrated Single DishDrawer™ Dishwasher with Door Panel and Contemporary Square Handle](#)
- [↓ Sketchup Integrated Single DishDrawer™ Dishwasher](#)
- [↓ Sketchup Integrated Single DishDrawer™ Dishwasher with Door Panel and Contemporary Square Handle](#)
- [↓ Specification Guide Integrated Single DishDrawer™ Dishwasher](#)
- [↓ User Guide Integrated DishDrawer™ Dishwasher](#)
- [↓ Wash Program Data DishDrawer™ Dishwasher EN](#)
- [↓ Wash Program Data Sheet EN](#)

Where applicable:

All appliances use energy, and energy usage typically generates carbon emissions. **Fisher & Paykel Appliances' In-use Energy Carbon Emissions Estimate** indicates carbon emissions from a product's in-use energy. This is calculated either annually or per cycle, using the product's market-specific energy label energy consumption data multiplied by the carbon emissions factor for energy in your country or region.

Our In-use Energy Carbon Emissions Estimate is designed to assist customers in making informed purchasing decisions when comparing different Fisher & Paykel products. For example, a heat pump dryer typically has a lower In-use Energy Carbon Emissions Estimate than a vented dryer.



A PEACE OF MIND SALE
24 Hours 7 Days a Week Customer Support

T 08000886605 W www.fisherpaykel.com