

FISHER & PAYKEL

**INTEGRATED
REFRIGERATOR & FREEZER**

INTEGRATED REFRIGERATOR FREEZER

RS6019B models

INTEGRATED REFRIGERATOR

RS6019S2 & RS6019S3 models

INTEGRATED FREEZER

RS6019F2 & RS6019F3 models

USER GUIDE

NZ AU UK IE HK SG EU

CONTENTS

Safety and warnings	5
Before you begin	10
Control panel	13
Food modes	14
Features	15
Settings	16
Wi-Fi connection	17
Adjusting the temperature	18
Food mode presets	19
Changing features	20
Changing settings	21
Water dispenser	22
Ice maker	23
Storage features	24
Care and cleaning	25
Food care	29
User warnings and sounds	30
Troubleshooting	31
European Directive 2012/19/EU on Waste Electrical and Electronic Equipment (WEEE)	34
Manufacturer's Warranty and Service guide	35

Registration

To register your product visit our website: fisherpaykel.com/register

⚠ WARNING!



Electric Shock Hazard

Failure to do so can result in death, electric shock, fire or injury to persons.

- Read and follow the safety and warnings outlined in this user guide before operating this appliance.

⚠ WARNING!



This appliance contains flammable refrigerant isobutane (R600a).

SAFETY AND WARNINGS

READ AND SAVE THIS GUIDE

WARNING!

Read entire manual. Failure to follow all guides and rules could cause personal injury or property damage. When using this appliance, always exercise basic safety precautions including the following:

General Use

- This appliance is designed for use in a normal domestic (residential) environment.
- Children should be supervised to ensure that they do not play with the appliance.
- Children aged 3 to 8 years may load and unload this appliance under supervision.
- Cleaning and user maintenance shall not be undertaken by children without supervision.
- This appliance can be used by children aged from 8 years and above and persons with reduced physical, sensory or mental capabilities or lack of experience and knowledge if they have been given supervision or instruction concerning use of the appliance in a safe way and understand the hazards involved.
- The manufacturer's installation instructions for appliance and cabinetry ventilation must be followed when installing the appliance.
- To avoid hazard due to instability of the appliance, it must be fixed in accordance with installation guide.
- Keep ventilation openings, in the appliance enclosure or in the built-in structure, clear of obstruction.
- Do not use mechanical devices or other means to accelerate the defrosting process, other than those recommended by the manufacturer.
- Do not damage the refrigerant circuit. In case of damage to the refrigerant circuit, ventilate the area by opening all windows.
- It is hazardous for anyone other than a Fisher & Paykel trained and supported service technician to service this appliance.
- When installing the appliance, use new tubing supplied with the appliance. DO NOT reuse any existing water connections.
- Avoid contact with the moving parts of the ice maker ejector mechanism, and do not place your fingers on the automatic ice-making mechanism while the appliance is in operation.
- It is hazardous for anyone other than an Authorised Service Person to service this appliance. In Queensland - the authorized Service Person MUST hold a Gas Work Authorisation for hydrocarbon refrigerants, to carry out Servicing or repairs which involve the removal of covers.

Installation

- Ensure that the appliance is secured to prevent tipping forward. Tipping of appliance can lead to serious injury or death.
- Connect to potable water supply only.
- The water connection to your Ice and water appliance must be installed by a qualified plumber or Fisher & Paykel trained and supported service technician and comply with all state and local laws.
- Installation and use MUST comply with all state and local plumbing codes. Check with your local public works department for plumbing codes. You must follow their guidelines as you install the water filtration system.

SAFETY AND WARNINGS

- Your water filtration system can withstand up to 120psi (827kPa) of water pressure.
- If a pressure limiting valve is supplied, ensure that it is installed before installing the water filtration system. DO NOT install if water pressure exceeds 120psi (827kPa).

WARNING!

To reduce the risk associated with choking:

- DO NOT allow children under 3 years of age to have access to small parts during the installation of the water filter.

Electrical

- Do not plug in any other appliance at the same power point as your appliance or use extension cords or double adapters.
- When moving your appliance away from the wall, be careful not to roll over or damage the power cord.
- When positioning the appliance, ensure the power cord is not trapped or damaged. If the power cord is damaged, it must only be replaced by your Fisher & Paykel trained and supported service technician.
- Do not operate electrical equipment or any other equipment that may produce arcs, sparks or flames in the area. Contact your Fisher & Paykel trained and supported service technician immediately to arrange for the appliance to be repaired.
- Do not use electrical appliances inside the food storage compartments of the appliance, unless they are of the type recommended by the manufacturer.
- Do not locate multiple portable socket-outlets or portable power supplies at the rear of the appliance.

Temperature control

- This refrigerating appliance is intended to be used at ambient temperatures ranging from 16 °C to 43 °C. The appliance performance may be compromised when operating outside of the temperature range.
- Once you turn on your appliance for the first time, the cooling system will automatically cool all compartments to their set temperatures. This will take between 2 - 3 hours.
- The control panel enables you to change and control the temperatures of the compartments accurately and independently regardless of the temperature or humidity of the surroundings whether it is summer or winter.
- We recommend checking the operation of your appliance once every 4 hours for the first 24 hours.
- If at any time you notice that the appliance is not cooling properly, call your installer or Fisher & Paykel trained and supported service technician to verify if the unit is operating properly. Take immediate steps to prevent food from spoiling by storing in another appliance or freezer.
- For common foodstuffs, factory default setting provides the optimum setting for food care. Storing at temperatures other than settings recommended may impact the storage life.
- For storage of general household foods in the most efficient manner, it is recommended to use the product in the factory configuration supplied. Moving the shelves and bins will have a minimal impact on efficiency.

SAFETY AND WARNINGS

Servicing

- Your appliance is designed to operate for many years without the need for service checks. However, if your appliance is malfunctioning, have it attended to by your Fisher & Paykel trained and supported service technician as soon as possible.
- All electrical repairs must be carried out by an adequately trained service technician or qualified electrician.
- Electrical shock hazard. Assume all parts are live.
- Disconnect supply before servicing and installation.
- The LED light cannot be serviced by the user. Contact your Fisher & Paykel Dealer or Fisher & Paykel trained and supported service technician.
- For spare parts, please contact Fisher & Paykel Customer Care. Spare parts are available for all Fisher & Paykel appliances for a minimum period of 10 years from the date of manufacture.

IMPORTANT!

Your appliance is designed to operate for many years without the need for service checks. However, if your appliance is malfunctioning, have it attended to by your Fisher & Paykel trained and supported service technician as soon as possible.

Cleaning

- If the appliance is left empty for long periods, switch off, defrost, clean, dry, and leave the door open to prevent mould developing within the appliance.
- Clean water tanks if they have not been used for 48 hours. Flush the water filter connected to a water system if water has not been drained for 5 days.
- Use only soap-based cleaning products. Many commercially available cleaning products contain solvents that may degrade the plastic components of your refrigerator and cause them to crack
- Avoid using anti-bacterial cleaning products on either the interior or exterior of the cabinet as they may cause rusting of metal components and cracking of plastic components.
- Regularly clean accessible draining systems and surfaces that come in contact with food.

Disposal

- Extreme care must be taken when disposing of your old appliance to avoid hazards:
 - The flammable refrigerant gas must be safely removed by a qualified service technician.
 - The thermal insulation foam in this appliance contains flammable insulation which can emit gases. Any exposed foam may be highly flammable and must be carefully treated during disposal.
- **WARNING:** Risk of child entrapment. Before you throw away your old refrigerator or freezer, the doors and panels should be removed and the racks left in place so that children may not easily climb inside.
- Consult your local energy authority or local codes as to the best way to dispose of your old appliance.
- Your Fisher & Paykel trained and supported service technician will be able to give advice on environmentally-friendly methods of disposing of your old appliance or freezer.
- Remove all packaging and dispose of it responsibly. Recycle items that you can.

SAFETY AND WARNINGS

Storing food and drinks

- Only models with 4-star compartment(s) are suitable for the freezing of foodstuffs.
- Ensure hot foods and beverages are cooled sufficiently before placing them into the appliance. Hot items may cause other foods to warm to unsafe temperatures. It may also cause sealed items to sweat/condensate which is undesirable.
- Ensure partially or fully defrosted foods are never re-frozen — cook immediately.
- Consume food items within the recommended storage times. Discard foods that show sign of spoilage.
- Store perishable foods in the appliance immediately after purchase. Storing at room temperature increases the rate of deterioration and can allow harmful microbial growth.
- Store any raw meat or fish in sealed containers to prevent cross-contamination.
- Immediately clean any drips or spills on surfaces.
- Do not store explosive substances such as aerosol cans with a flammable propellant in this appliance.
- Never store volatile or flammable materials in your appliance as they may explode.
- Do not consume food if it is too cold. Food removed from freezer compartment may be cold enough to cause damage when brought into contact with bare skin, eg frozen ice cubes.
- Opening the door for long periods of time can cause a significant increase of the temperature in the compartments of the appliance.
- Never freeze liquids in glass containers. Liquid expands when it freezes and can cause the container to explode.
- Never freeze carbonated drinks. They may explode.

IMPORTANT!

If you suspect that the product is not getting cold — items such as ice cream are melting — remove all perishable food and store in another appliance or cooler to prevent spoilage. Immediately call for a service technician.

Power failure

- Do not refreeze frozen foods that have thawed completely.
- Foods that have defrosted but are still cold may be cooked immediately.
- Foods that have defrosted and are warmer than 5°C should be discarded.

You can identify the model information on the serial plate located on the inside or outer edge of the lower compartment.

Energy Labelling and Eco-design

- This product contains light sources of energy efficiency class F.
- Information on product can be found in European Product Database (EPREL) at the following link <http://eprel.ec.europa.eu/>. You will be asked to enter the model identifier.

BEFORE YOU BEGIN

Dual Zone Refrigerator (RS6019S2)

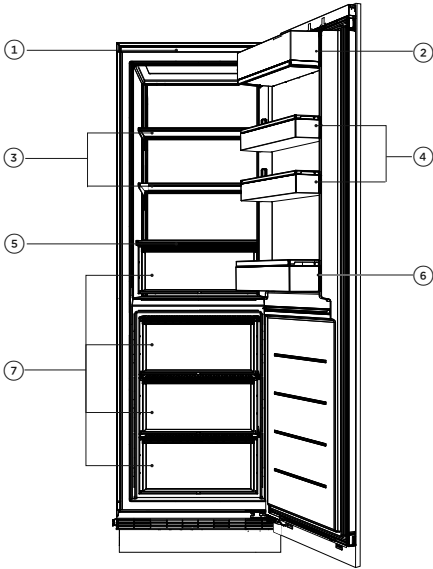

Features

- ① Control panel
- ② Dairy compartment
- ③ Adjustable shelving
- ④ Door shelves
- ⑤ Bottle holder accessory
- ⑥ Bottle shelf
- ⑦ Humidity control bins

Dual Zone Freezer (RS6019F2)

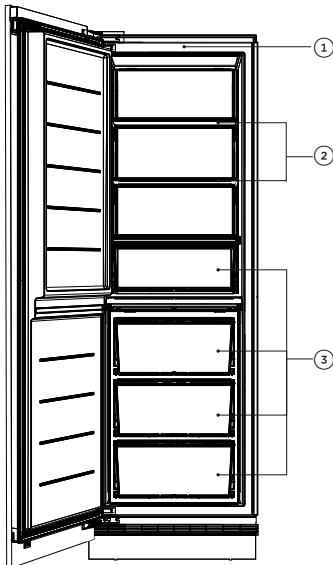

Features

- ① Control panel
- ② Adjustable shelving
- ③ Freezer bins

BEFORE YOU BEGIN

Triple Zone Refrigerator (RS6019S3)

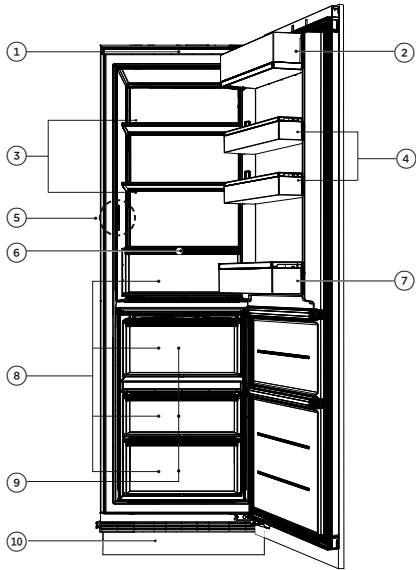

Features

- ① Control panel
- ② Dairy compartment
- ③ Adjustable shelving
- ④ Door shelves
- ⑤ Internal water dispenser*
- ⑥ Bottle holder accessory
- ⑦ Bottle shelf
- ⑧ Humidity control bins
- ⑨ Variable temperature zone
- ⑩ Water filter (not shown)

*Located in inner left side wall of the top compartment.

Triple Zone Freezer (RS6019F3)

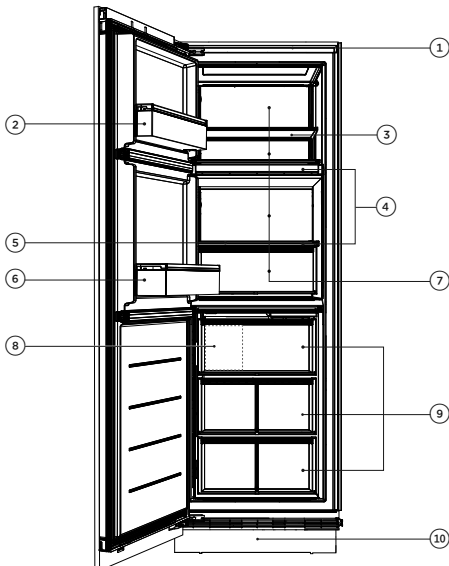

Features

- ① Control panel
- ② Pocket shelf
- ③ Adjustable shelving
- ④ Fixed shelves
- ⑤ Bottle holder accessory
- ⑥ Bottle shelf
- ⑦ Variable temperature zones
- ⑧ Automatic ice maker (not shown)*
- ⑨ Freezer bins
- ⑩ Water filter (not shown)

*Located inside freezer bin.

BEFORE YOU BEGIN

Bottom mount refrigerator (RS6019B)

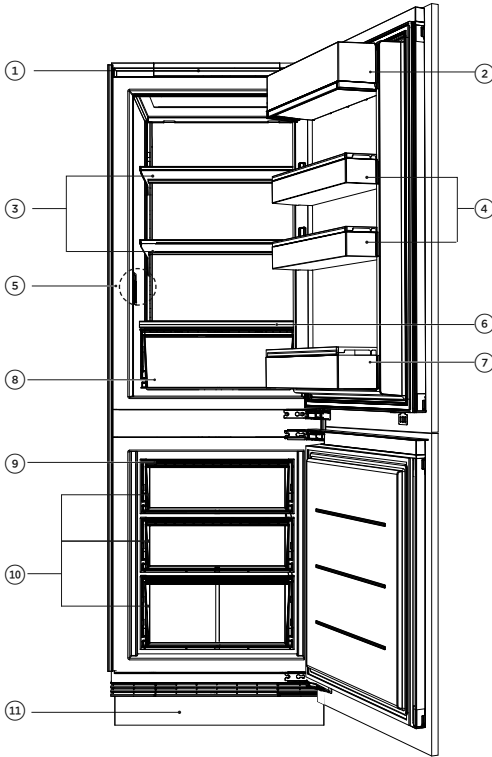

Features

- ① Control panel
- ② Dairy compartment
- ③ Adjustable shelving
- ④ Door shelves
- ⑤ Internal water dispenser*
- ⑥ Bottle holder accessory
- ⑦ Bottle shelf
- ⑧ Humidity control bin
- ⑨ Ice maker (not shown)
- ⑩ Freezer bins
- ⑪ Water filter (not shown)

*Located in inner left side wall of the top compartment.

CONTROL PANEL

Bottom mount / Dual Zone Refrigerator / Freezer

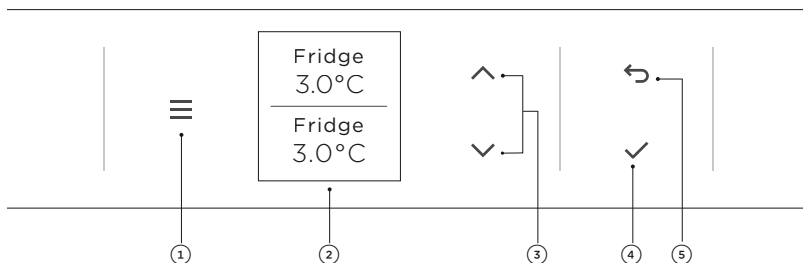

Triple Zone Refrigerator / Freezer

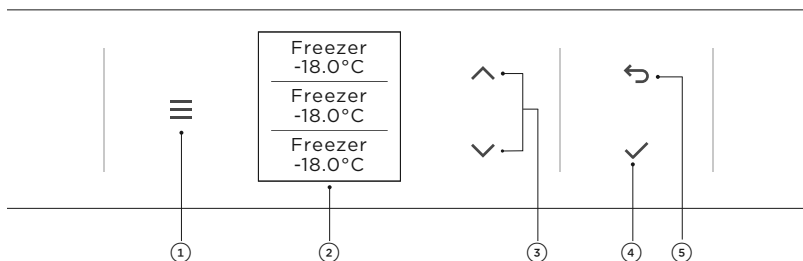

① Menu	Press to access product features and settings, or to return to standby. If the display has been locked, hold for two seconds to unlock.
② Display screen	Displays product features and settings.
③ Scroll	Press to select food modes and adjust temperatures. Enables you to scroll through the menu, features and settings.
④ Select	Press to confirm and activate the selected features and settings.
⑤ Back	Press to go back to the previous menu.

Install mode

When the product is first delivered it is in Install Mode to help assist installers.

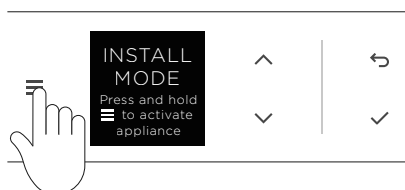

Press and hold ≡ to activate the appliance and display the menu.

FOOD MODES

Variable temperature zones

Separate zones allow for different temperature settings and food modes for a variety of foods.

FOOD MODES	DESCRIPTION	TYPES OF FOOD TO STORE
PANTRY (12°C)	<p>PANTRY mode provides a cool, dark place for a wide variety of foods that perish quickly or may spoil at room temperature, but are too sensitive to be stored at normal refrigerator temperatures.</p> <p>PANTRY mode runs under Cellar Compartment storage conditions as per Commission Regulation (EU) 2019/2019.</p>	<p>Bananas, avocados, tomatoes tropical fruits, root vegetables.</p> <p>Dry food items such as grains, flours, sugars, crackers, cereal, baked goods, tortillas, wraps and breads.</p> <p>Spreads, preserves, honey, tropical fruits, nuts and seeds, chocolate and fresh herbs.</p> <p>Wine</p>
FRIDGE (3°C)	<p>The ideal mode for fresh, everyday foods. This mode offers a higher relative humidity than many other refrigerators allowing fresh foods such as fruits and vegetables, meats and cheeses to stay fresher for longer.</p>	<p>Fruit and vegetables, dairy products, jams and chutneys/ preserves, meats and drinks.</p>
CHILL (-0.5°C)	<p>CHILL mode is an extension of FRIDGE mode, providing the perfect storage zone for highly perishable food to ensure they retain their vital freshness and quality. These items will last slightly longer here compared with storage at FRIDGE mode.</p>	<p>Highly perishable meats, poultry and seafood.</p> <p>Alcoholic beverages such as beer.</p>
SOFT FREEZE (-9°C)	<p>SOFT FREEZE mode is an extension of your refrigerator, extending the shelf life of perishable items while maintaining the quality. SOFT FREEZE mode allows easy portioning of food and the ability to heat, cook or serve foods straight from the compartment without waiting for it to thaw.</p>	<p>Meats, seafood, soups, sauces, pureed foods, bread, desserts and pastries.</p> <p>Soft Freeze mode is not recommended for storage of creamy desserts such as ice cream.</p>
FREEZER (-18°C)	<p>FREEZER mode is for general frozen food items that require storage between 1-12 months.</p>	<p>Meat, poultry, seafood, pre-cooked foods and leftovers, some fruits and vegetable, ice cream, and other frozen desserts.</p>

Not all food modes available on every model.
Some food modes cannot be used in combination.

FEATURES

FEATURE	DESCRIPTION
ICE	<p>Turns on or off your automatic ice maker in the bottom compartment. Your ice maker is designed to automatically dispense ice into the ice storage bin below until it detects the bin is full. The more ice you use, the more it makes.</p> <p>Before first use the automatic ice system must be flushed. Refer to your install guide for further information.</p>
ICE BOOST	<p>Increases ice production and deactivates automatically after 24 hours.</p>
MAX COLD	<p>Boosts the cooling speed by dropping a compartment to its coldest temperature for a set time.</p> <p>Durations: Pantry - 6 hours, Fridge - 6 hours, Chill - 4 hours, Soft freeze - 12 hours & Freezer - 24 hours.</p> <p>Use MAX COLD when you are adding food items to your appliance such as after grocery shopping. This feature will ensure your food is chilled or frozen within the shortest period of time, locking in freshness and extending the shelf life of your food.</p>
BOTTLE CHILL	<p>Rapidly chills your beverages in the freezer for 15 minutes. Depending on the size of your beverage, the default time may not be enough to chill your beverage. If your beverage is not cold enough after the set time, return it to the compartment and reset the BOTTLE CHILL feature.</p>
WATER DISPENSER	<p>Enables you to lock and unlock the water dispenser.</p>
DOOR ALARM	<p>Allows you to temporarily mute door alarms. It will automatically disable after 20 minutes or when the doors are closed.</p>
DISPLAY LOCK/UNLOCK	<p>Enables you to disable the buttons on the control panel. This is useful when cleaning your appliance.</p>
SABBATH	<p>In SABBATH, alarms, lights and displays are deactivated for 80 hours:</p> <ul style="list-style-type: none">• The interior light will not turn on when you open the refrigerator.• The door alarms will not operate.• The display will not illuminate, except the SABBATH.• The control panel will not operate.• Sabbath mode automatically deactivates after 80 hours. <p>If you turn off your refrigerator while in SABBATH, it will resume automatically once the refrigerator is switched on again.</p>

Not all features available on every model.

SETTINGS

SETTING	DESCRIPTION
WI-FI SETUP	May enable you to connect to your home wireless network and operate remotely using the app.
WATER FILTER TIMER RESET	Enables you to reset the water filter replacement reminders. Reminders are set for every six months.
FORCE ICE FLIP	Enables you to force the ice tray to flip. This is used when flushing the water filter after a vacation or when the filter has been replaced.
DISPLAY SOUND	Enables you to silence all control panel sounds.
DISPLAY BRIGHTNESS	Enables you to adjust the brightness of the display on the control panel.
TEMPERATURE UNITS	Enables you to change the unit of temperature shown on the display screen between Celsius (°C) and Fahrenheit (°F).
WATER FILTER REMINDERS	Enables a notification to indicate when the water filter must be replaced.
FACTORY RESET	Enables you to reset your appliance to the default factory settings.

WI-FI CONNECTION

Getting started

Your appliance may be connected to your home wireless network and operated remotely using the app.

- Ensure your home Wi-Fi network is turned on.
- You will be given step by step guidance on both your appliance and mobile device.
- It may take up to 10 minutes to connect your appliance.

On your mobile device:

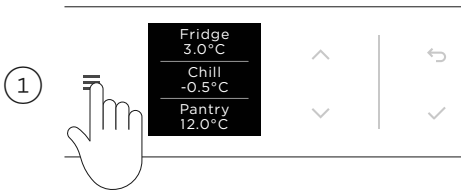

- ① Download the app from www.fisherpaykel.com/connect
- ② Register and create an account.
- ③ Add your appliance and set up the Wi-Fi connection.

Connecting to Wi-Fi



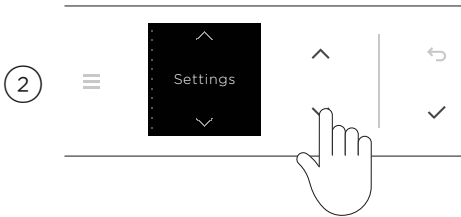



Press  to display the menu.

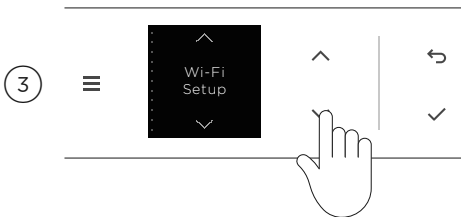

Press  or  to scroll through the list and select **SETTINGS**.

Press  to confirm.



Press  or  to scroll through the list and select **WI-FI SETUP**. Press  to confirm.

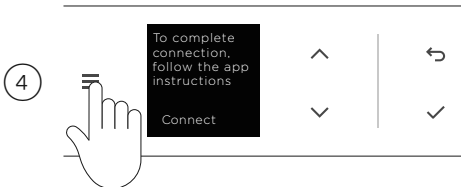

Follow the prompts on screen and in the app to complete set-up.

ADJUSTING THE TEMPERATURE

Adjusting the temperature from quick access

When you turn on your appliance for the first time, the cooling system will automatically cool all compartments to their default food mode and temperature (Fridge and 3C for refrigerators and Freezer and -18C for freezers). This will take about 2-3 hours.

The temperature can be adjusted to user's preference. Follow the steps below to quickly adjust the temperature of the food mode in each compartment.

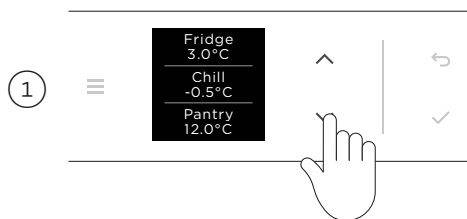

From the idle screen, press ∇ or \blacktriangle to select the desired compartment.



Press \checkmark to confirm the selection.

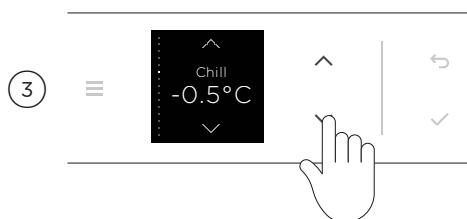

Press ∇ or \blacktriangle to increase or decrease the temperature.



Press \checkmark to confirm.

A confirmation screen will appear and the change will be reflected on the idle screen.



FOOD MODE PRESETS

Food modes have been grouped into preset combinations. Ensure each compartment is running the intended food mode and is appropriate for the foods being stored. Ensure the appropriate food mode has been selected for the food types you wish to store. Refer to 'Food modes' and 'Food care' for information.

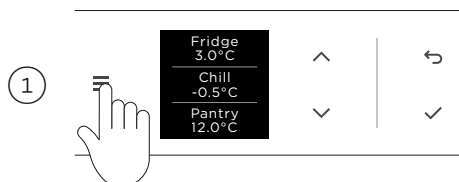

Follow the steps below to adjust the food mode in each compartment.

- 



1

Press 
- 

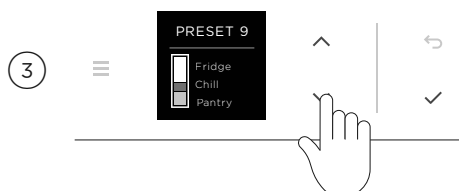
2

Press  or  to scroll through the list to Food Mode Presets.
Press  to confirm.
- 

3

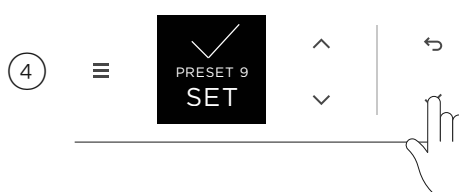
Press  or  to scroll through the preset combinations.
- 

4

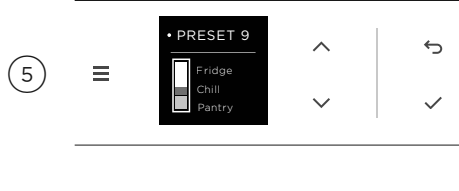
Press  to select the desired Food Mode combination.
- 

5

The active Food Mode preset will show first in the list of presets, and be reflected by a dot adjacent to the preset number.
- 

6

The food mode combination in use will be shown on the idle screen.

CHANGING FEATURES

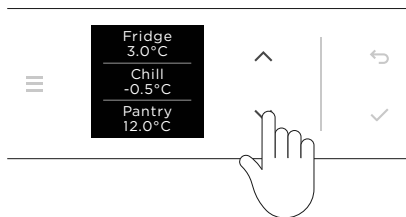

1



Press  to display the menu.

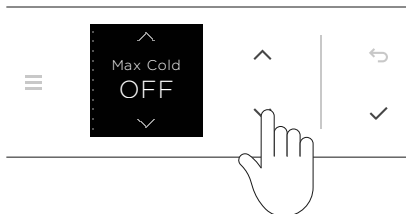

2

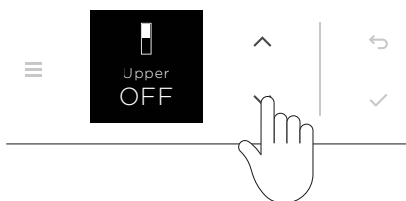

Press  or  to scroll through the list and select the required feature. Press  to confirm.

3



Press  or  to select the desired compartment if applicable for the feature.

4

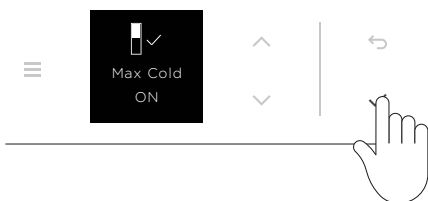

Press  to activate/deactivate the feature.

CHANGING SETTINGS



1



Press  to display the menu.

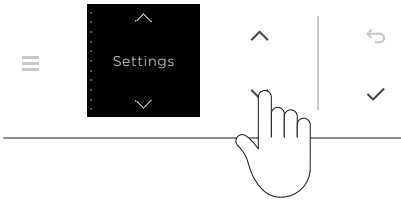

2



Press  or  to scroll through the list and locate **SETTINGS**.
Press  to confirm.

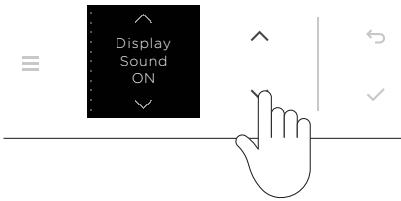

3

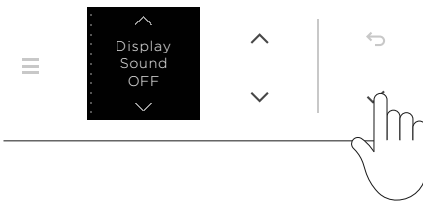

Press  or  to scroll through the list and locate the desired setting.

4



Press  to change the setting or to enter the setting for more setting options.
Press  to confirm the selection.

WATER DISPENSER

Using the water dispenser (Triple Zone Refrigerator and B model)

The water dispenser is located inside on the left side wall of the top compartment.

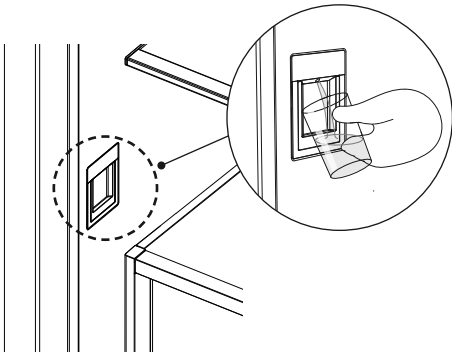

To dispense water, gently press the dispensing pad with a glass or container.

To stop the flow of water, simply pull your glass or container away from the dispensing pad.

Pressing hard against the dispensing pad will not increase the flow or dispense more water.

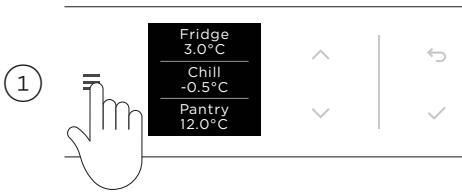

When dispensing water for long durations a time out period may occur. An alarm will sound. Please wait 4 minutes before dispensing again.

Locking/unlocking the water dispenser

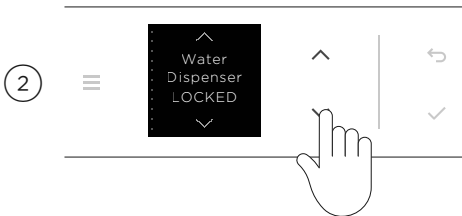

Press  to display the menu.



Press  or  to scroll to WATER DISPENSER.

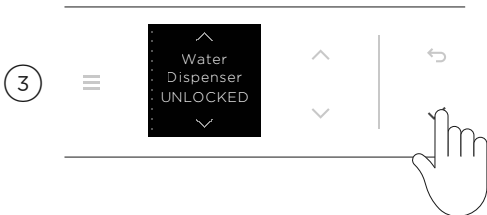

Press  to lock or unlock the water dispenser.

ICE MAKER

Your automatic ice maker will produce ice into the storage bin below. Ice making will continue until the storage bin is full. Ice making will resume once you start to use the stored ice.

On initial start up of your appliance, your ice maker may take several hours to produce ice. This is normal. Please ensure the ice maker feature is turned **ON**. Refer to 'Changing features'.

- An ice scoop is provided for hygienic use.

If a large amount of ice is required, remove the storage bin and allow ice to fall into the larger bin. For maximum ice storage, level the stored cubes with the ice scoop.

Empty the ice storage bin periodically discarding any old ice. Wash and dry the storage bin thoroughly and place back into the correct position. Refer to 'Care and cleaning'.

Turn your ice maker off if:

- There is no water supply for several hours.
- You are removing the ice storage bin for a long period of time.
- You are going on holiday/vacation.

STORAGE FEATURES

REFRIGERATOR

Fruits and vegetables bins with humidity control lids

Lids create a humid microclimate by reducing dry air going into the bins. The specially designed grooves retain condensation, keeping humidity high and reduce dripping onto the produce below.

Separate fruits and vegetables to prevent ethylene-sensitive produce from ripening too quickly.

Also used for storing deli items and beverages, or defrosting foods.

Cantilever glass shelving

Heat-treated safety glass.

Can be removed and positioned at heights to suit your storage requirements.

Dairy shelf and door shelves

The top door shelf is a dairy compartment for storing butter and cheeses.

The middle shelves are designed for general items, condiments and drinks.

The bottom shelf is designed to store large drinks or those drinks you require frequent access to.

Shelves are adjustable

Single bottle holders

Can be placed along the length of any shelf to store a variety of bottles.

Store bottles with the neck facing the front of the refrigerator.

FREEZER

Cantilever glass shelving (RS6019F2 and RS6019F3)

Heat-treated safety glass.

Can be removed and positioned at heights to suit your storage requirements.

Door Shelves (RS6019F3)

Designed for general frozen items and alcoholic beverages such as spirits (**FREEZER** and **SOFT FREEZE**) and beer and wine (**CHILL**).

Ice Maker (Ice & Water models only)

Removable ice container. (RF6019B & RS6019F3 only)

Hygienic ice scoop. (RF6019B & RS6019F3 only)

Freezer bins

Allow for easy storage of frozen food items.

CARE AND CLEANING

Do not use harsh chemicals, abrasives, ammonia, chlorine, bleach, concentrated detergents, solvents or abrasive scouring pads on any part of your appliance. Some of these chemicals may damage your appliance.

Clean all surfaces with a mild liquid detergent dissolved in warm water and a soft cloth. Rinse with clean water and dry with a clean, lint-free cloth.

Exterior cleaning

Condenser coils

The condenser coils of your appliance requires periodic cleaning by a Fisher & Paykel trained and supported service technician.

Toe kick grilles and filter

We recommend cleaning the grille and filter in conjunction with changing your water filter every 6 months.

- ① To maximize operating efficiency, keep ventilation openings clear of obstructions by regularly vacuuming the flooring in front of your appliance.
- ② More frequent cleaning may be necessary for dusty homes or those with pets shedding hair.

Interior cleaning

Cantilevered glass shelves

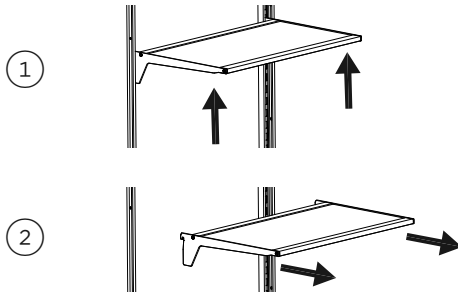

To remove, hold the front and back edge of the shelf firmly.

Push the shelf up vertically to dislodge from back support lugs.

Pull the shelf towards you.

Fixed shelf

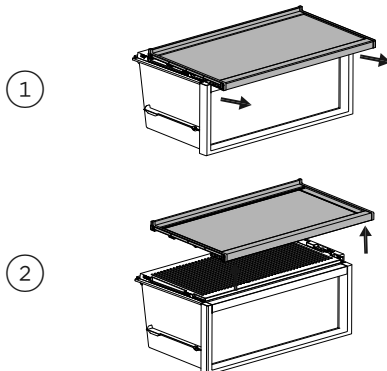

Pull the shelf towards you to release the clips.

Lift shelf up to remove.

CARE AND CLEANING

Removing the bins

The runners are pre-lubricated to help open and close the bins. Do not remove the grease from the runners to maintain its smooth function. If the bins are not regularly fully extended, the extension of the runners may be reduced. To restore the extension of the runners pull them out.

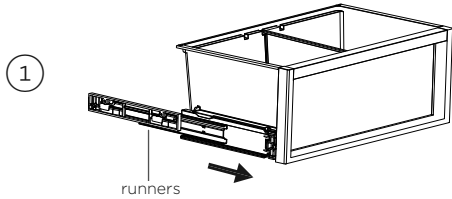

To remove a bin, extend the bin on its runners, and empty the bin.

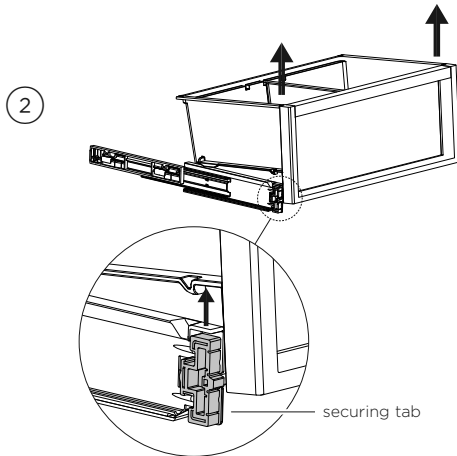

Push the securing tabs on both sides of the bin corners, then push the bin firmly upwards to dislodge from the runners.

CARE AND CLEANING

Humidity control lids (Upper Compartment)

1

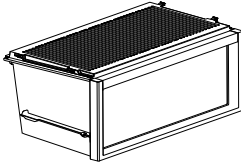

Remove fixed shelf.

2

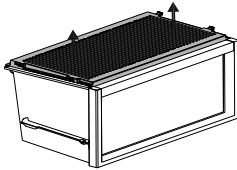

Lift the humidity control lid upwards to remove

Humidity control lids (Lower Compartment)

1

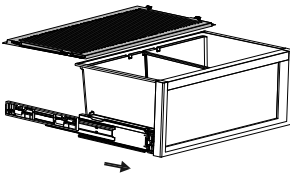

Remove the bin.

2



Pull the humidity control lid towards you to release the clip.

3



Lift lid up and slide out to remove.

CARE AND CLEANING

Removing the bins

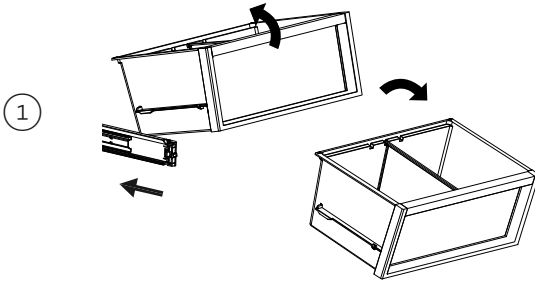

Pull the bin towards you to remove. Push both runners back into the appliance.

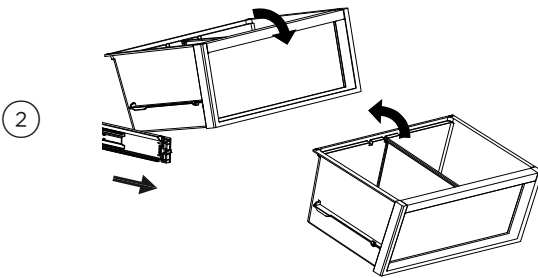

To return the bin, extend the runners and place the bin on top of the runners.

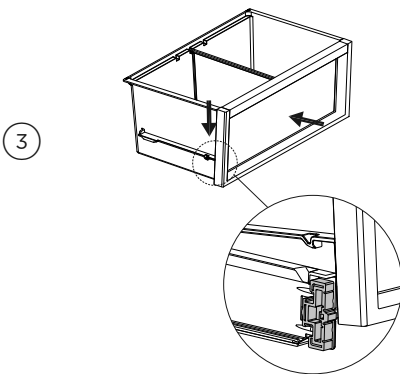

Push the bin slowly onto the securing tabs until you feel it clip onto the runners. Ensure the bin tabs are clipped securely onto the runners before use.

Holiday/vacation (Freezer only)

Before leaving:

Turn the ice maker to **OFF** on the control panel.
Shut off the water supply to the appliance.

On return:

Turn on the ice maker. Discard the first full bin of ice.

FOOD CARE

For best food care

- Store only high-quality, fresh food in your appliance.
- Store perishable foods in the appliance immediately after purchase. Storing at room temperature increases the rate of deterioration and can allow harmful microbial growth.
- Foods such as meat, poultry and seafood should be well wrapped or sealed in suitable packaging to prevent dehydration, color deterioration, loss of flavor, and transfer of odor.
Note: We recommend storing these foods on the bottom shelf of your appliance or in one of the bins to prevent potential spills and cross-contamination with other foods.
- Ensure hot foods and beverages are cooled sufficiently before placing them into the appliance. Hot items may cause other foods to warm to unsafe temperatures. It may also cause sealed items to sweat/condensate — which is undesirable.
- Beverages are best stored standing upright in the door shelves or on the bottle racks provided.
- Ensure raw and cooked foods are stored separately to avoid cross-contamination.
- Consume food items within the recommended storage times. Discard foods that show sign of spoilage.
- Keep door openings to a minimum to maintain optimum storage temperatures inside your appliance.
- We recommend using **MAX COLD** when you are adding food items to your appliance, such as after grocery shopping. This feature will ensure the food is chilled/frozen within the shortest period of time, locking in the freshness and extending the shelf life of your food.
- Storing at temperatures other than the recommended settings may impact the storage life.

Items stored in your refrigerator

- Dairy items such as butter and cheeses should be stored in the covered door shelf to minimize any transfer of odor or odor absorption from other foods.
- Eggs should be stored in their carton to avoid absorption of strong odors through their porous shell structure.
- Fruits & vegetables should be stored in the humidity control bins. These bins provide a humid microclimate to extend the storage times of fruit and vegetables.

Items stored in your freezer

We recommended cooling carbonated beverages only when the **BOTTLE CHILL** function is active.

Do not store carbonated drinks without this function when set to freezer mode. Failure to remove beverages could lead to freezing liquid and the likelihood of bottle/can explosion.

- Ensure air is removed from packaging to avoid large formation of ice crystals and prevent freezer burn.
- To maintain freshness and quality, we recommend defrosting foods in the refrigerator. Ensure partially or fully defrosted foods are never re-frozen — cook immediately.

USER WARNINGS AND SOUNDS

Faults

- In the unlikely event a fault occurs, 4 rapid beeps will be heard and the fault will be displayed on the control panel.
- Record the fault code displayed on the control panel and contact a Fisher & Paykel trained and supported service technician in order to repair the fault. You can do this by going online to fisherpaykel.com or by contacting our Customer Care Center.

Normal appliance sounds

Integrated Refrigerators and Freezers have been designed to have excellent energy ratings and cooling performance. As a result, it can produce sounds somewhat different to your old appliance.

Low frequency ticking	This is the valve that controls cooling to each compartment. This noise will only last for a few seconds at a time.
Fan air flow	This product has fans which change speed depending on demand. During cooling periods, such as after frequent door openings, fans circulate the cold air in the appliance producing some air flow sound. This is quite normal.
Cracking or popping	This may occur when the automatic defrost function is operating.
Running water	This is the liquid refrigerant in the system and can be heard as a boiling or gurgling noise.
Hissing sound after closing the freezer door	This is due to the pressure difference between the warm air that has entered the cabinet and suddenly cooled, and the outside air pressure.
Humming	This is the compressor running and is quite normal.
Ice maker noises	Motor operation (low humming). Running water as the ice maker and/or water tank fills. Water valve opening and closing (hissing sound). Loosened from the ice molding tray (cracking). Ice dropping into bin (clunking).
Other sounds	Cabinet not stable or level. Bottles or jars rattling on shelves.

TROUBLESHOOTING

If there is a problem with your appliance, please check the following points before contacting your local Fisher & Paykel trained and supported service technician or the Customer Care Centre.

Product parts and accessories can be purchased through the Fisher & Paykel Customer Care Centre, or online at fisherpaykel.com (this service is available to selected markets only).

PROBLEM	POSSIBLE CAUSES	WHAT TO DO
Appliance does not operate	No electricity at power outlet.	Check that the plug is correctly connected and power switched on.
		Check another appliance at the same outlet.
		Check house breaker.
Light not working	Light not functioning.	The lighting cannot be serviced by the user. Contact your Fisher & Paykel dealer or trained and supported service technician.
	Appliance not working.	Check appliance is turned on at the wall or at the isolating switch.
Light and display not working	Product in SABBATH .	Press  and hold to unlock, scroll to SABBATH and deactivate.
Storage compartments too warm	Temperature setting not correct.	Refer to 'Food modes'.
	Frequent door openings.	Minimize door openings to allow temperature to stabilize.
	Large amount of food has been recently added.	Select MAX COLD to assist in lowering the temperature quickly.
Food freezing in the refrigerator	Temperature setting is too cold.	Increase the temperature setting. Refer to 'Adjusting the temperature' and 'Food modes'.
	Food placed directly in front of air outlets.	Move chill sensitive foods away from the air outlets.
Unfamiliar noises	Cabinet not stable or level.	See Installation guide supplied with this appliance.
	Freezer is defrosting.	This is normal.
Ice maker sounds	Normal ice maker operation.	Refer to 'User warnings and sounds'.
Food Mode is not available	Not all food modes are available in all compartments.	Refer to 'Food mode presets' for available food mode combinations.

TROUBLESHOOTING

PROBLEM	POSSIBLE CAUSES	WHAT TO DO
When the appliance door is opened 4 rapid beeps sound and a code is displayed on the control panel		Record the code on the control panel and contact Customer Care Center.
Water in the vegetable bins	Condensation is generated due to humid environments caused by fruits and vegetables.	Some condensation is beneficial for storage of fruits and vegetables. Wipe out water with a cloth.
Condensation/ice inside compartment	Frequent or long door openings.	Minimize door openings.
	Door gasket leaking.	Check and clean door gasket seal.
	Not unusual during periods of high humidity.	Wipe dry.
	Door not closing tightly.	Arrange items in the compartment so door can close tightly.
	Doors not aligned.	Call a service technician.
Bin does not slide in and out evenly	Packaging trapped.	Check to ensure no food or packaging is trapped behind the tray/bin.
Door not closing	An obstruction is blocking door closing.	Move obstruction.
	Appliance not installed correctly.	Refer to your Installation guide supplied with this appliance to ensure your appliance has been installed correctly.
Freezer door will not open	The door has been recently opened.	Wait 30 seconds and try again.
Small or large ice cubes	Water line is kinked/squashed.	Check the external water line is not kinked/squashed. If it is not kinked/squashed contact Customer Care to arrange a technician to check the internal water line.
	Blocked water filter.	Change filter before calling technicians.
Frozen food items are soft or melting		Remove items and place in another freezer or cooler and call Customer Care immediately.
	Temperature setting not correct.	Adjust the temperature setting. Refer to 'Food modes'.

TROUBLESHOOTING

PROBLEM	POSSIBLE CAUSES	WHAT TO DO
Automatic ice maker does not work	Ice maker has not been turned on.	Switch on ice maker, refer to 'Changing features'.
	Water supply turned off or not connected.	Connect the water supply.
	Water pressure too low.	Check water pressure.
	Water line kinked/squashed.	Check water line for kinks/squashing.
	Filter is clogged.	Water filter may need replacing.
	Ice cubes clumped in bin.	Remove ice storage bin, loosen cubes and remove clumped ice. Replace ice storage bin.
	Freezer compartment not working.	Contact Customer Care Center.
Ice cubes taste tainted	Unsealed foods may be transmitting odor/taste.	Discard ice cubes and clean ice storage bin. Refer to 'Interior cleaning'. Wrap or cover strong smelling foods.
	Poor taste from incoming water.	Replace filter cartridge product parts and accessories can be purchased through our Customer Care Center.
Slow ice cube freezing	Door may have been left ajar.	Close door.
	Freezer compartment set too warm.	Turn temperature to a colder setting. Refer to 'Adjusting the temperature'.
Wet ice/ ice clumping	Filter is blocked.	Replace filter cartridge.
	Long freezer door openings.	Gently tap ice to unstick or, if large clumps occur, empty ice bin and make new ice.
	High ambient temperature.	
	Ice bin left out of freezer compartment for a length of time.	
Ice will stick together over time.		
Ice is discolored	Water filter has not been flushed.	Refer to your installation guide supplied with your appliance for details on how to flush your water filter.

EUROPEAN DIRECTIVE 2012/19/EU ON WASTE ELECTRICAL AND ELECTRONIC EQUIPMENT (WEEE)

EU This appliance is marked according to the European Directive 2012/19/EU on Waste Electrical and Electronic Equipment (WEEE). By ensuring this product is disposed of correctly, you will help prevent potential negative consequences for the environment and human health, which could otherwise be caused by inappropriate handling of this product.

The symbol  marked on the serial plate, or on the documents accompanying the product, indicates that this appliance cannot be treated as household waste. It shall be handed over to the applicable collection point for the recycling of electrical and electronic equipment. Disposal of the appliance shall be carried out in accordance with the local environment regulations for waste disposal and ensure the refrigerant circuit is not damaged.

For more detailed information about treatment, recovery and recycling of this product, please contact your local city office, your household waste disposal service or your Fisher & Paykel retailer/dealer from whom you purchased this product.

MANUFACTURER'S WARRANTY AND SERVICE GUIDE

NZ



To access your Warranty and Service Guide

Scan the QR code with your smartphone to access your warranty and book a service, or view online at <https://www.fisherpaykel.com/nz/help-and-support/warranty-information>

AU



To access your Warranty and Service Guide

Scan the QR code with your smartphone to access your warranty and book a service, refer to your separate warranty and service book or view online at <https://www.fisherpaykel.com/au/help-and-support/warranty-information>

This product has been designed for use in a domestic (residential) environment. This product is not designed for any commercial use. Any commercial use by the customer will affect this products Manufacturer's Warranty.

Complete and keep for safe reference:

Model _____

Serial No. _____

Purchase Date _____

Purchaser _____

Dealer _____

Suburb _____

Town _____

Country _____

UK



To access your Warranty and Service Guide

Scan the QR code with your smartphone to access your warranty and book a service, or view online at <https://www.fisherpaykel.com/uk/help-and-support/warranty-information>

IE



To access your Warranty and Service Guide

Scan the QR code with your smartphone to access your warranty and book a service, or view online at <https://www.fisherpaykel.com/ie/help-and-support/warranty-information>

EU



To access your Warranty and Service Guide

Scan the QR code with your smartphone to access your warranty and book a service, or view online at <https://www.fisherpaykel.com/eu/help-and-support/warranty-information>

This product has been designed for use in a domestic (residential) environment. This product is not designed for any commercial use. Any commercial use by the customer will affect this products Manufacturer's Warranty.

For spare parts, please contact Fisher & Paykel Customer Care. Spare parts are available for all Fisher & Paykel products for a minimum period of 10 years from the date of manufacture.

CUSTOMER CARE

Before you call for service or assistance

Check the things you can do yourself. Refer to your User guide and check:

- ① Your product is correctly installed.
- ② You are familiar with its normal operation.
- ③ You have read the 'Before you call for service or assistance', 'Faults' and 'Troubleshooting'.

If after checking these points you still need assistance or parts, please refer to your nearest Fisher & Paykel trained and supported service technician, Customer Care, or contact us through our website [fisherpaykel.com](https://www.fisherpaykel.com).

MANUFACTURER'S WARRANTY AND SERVICE GUIDE

In UK if you need assistance

Call the Fisher & Paykel Customer Care Centre and talk to one of our Customer Care Consultants.

Toll Free: 08000 886 605

Website: fisherpaykel.com

Postal address:

Fisher & Paykel Appliances Ltd,
Turing House, Ortensia Drive,
Milton Keynes MK17 8LX

In Ireland if you need assistance

Call the Fisher & Paykel Customer Care Centre and talk to one of our Customer Care Consultants.

Toll Free: 1800 625174 or 01 807 7960

Website: fisherpaykel.com

Postal address:

Fisher & Paykel Appliances Ltd,
Unit 2D Corporate Park,
Swords Dublin

If you need service

Fisher & Paykel has a network of Fisher & Paykel trained and supported service technicians that can carry out any service necessary on your appliance. Our Customer Care Centre can recommend a Fisher & Paykel trained and supported service technician in your area. Or you can book one online at fisherpaykel.com/uk/help-and-support or fisherpaykel.com/ie/help-and-support

If you call, write or contact us via our website please provide:
your name and address, model number, serial number, date of purchase and a complete description of the problem. This information is needed in order to better respond to your request for assistance.

Product details can be found inside the cabinet at the bottom right.

Complete and keep for safe reference:

Model _____

Serial No. _____

Purchase Date _____

Purchaser _____

Dealer _____

Suburb _____

Town _____

Country _____

FISHERPAYKEL.COM

© Fisher & Paykel Appliances 2022. All rights reserved.

The models shown in this guide may not be available in all markets
and are subject to change at any time.

The product specifications in this guide apply to the specific products and
models described at the date of issue. Under our policy of continuous product
improvement, these specifications may change at any time.

For current details about model and specification availability in your country,
please go to our website or contact your local Fisher & Paykel dealer.

867351A 09.22