

FISHER & PAYKEL

**FRONT LOADER
WASHING MACHINE**

WM1490P2

USER GUIDE

BI EU

CONTENTS

Safety and warnings	5
Safety features	7
Control panel	9
Wash cycles	12
Detergent and softener	14
Wash preparation	17
Getting started quickly	19
Customising a wash cycle	21
Changing pre-set options	26
Factory reset	27
Caring for your washer	28
Before you call for service	33
Fault codes	35
Troubleshooting	36
Energy consumption and cycle times	41
Manufacturer's warranty	42
Customer care	42
European Directive 2012/19/EU on Waste Electrical and Electronic Equipment (WEEE)	44

Registration

To register your product visit our website: fisherpaykel.com/register

⚠ WARNING!



Electric Shock Hazard

Failure to follow this advice may result in electric shock or death.

- If you are using an extension cord or a portable electrical outlet device (eg multi-socket outlet box), ensure that it is positioned so that it does not come into contact with water or moisture.

READ AND SAVE THIS GUIDE

When using your clothes washer, follow basic precautions, including the following:

General

- This product has been designed for personal, family or household use. This product is not designed for any commercial use. Any commercial use will terminate this products manufacturer's warranty.
- A damaged power cord must be replaced by a Fisher & Paykel trained and supported service technician or similarly qualified person in order to avoid a hazard. Do not use the appliance until it has been repaired to avoid a risk of electric shock.
- Do not operate this machine if it has been damaged during transport. Contact your Fisher & Paykel dealer or Fisher & Paykel trained and supported service technician.
- This appliance can be used by children aged 8 years and above and persons with reduced physical, sensory or mental capabilities or lack of experience and knowledge if they have been given supervision or instruction concerning use of the appliance in a safe way and understand the hazards involved.
- Keep children away from the washer while it is in operation.
- Supervise children to ensure they do not play with the washer or climb inside the drum.
- Children of less than 3 years should be kept away unless continuously supervised.
- The washer should only be used for washing and rinsing of textiles where this is indicated on the care label.
- Do not add petrol, dry-cleaning solvents, or other flammable or explosive substances to the wash water. These substances give off vapours that could ignite or explode.
- Do not wash articles that have been previously cleaned in, washed in, soaked in, or spotted with gasoline, dry-cleaning solvents, or other flammable or explosive substances as they give off vapours that could ignite or explode.
- The door will be locked from the start of the cycle until the cycle is complete for safety reasons. It is possible to open the door during the cycle under certain conditions. Never force the door open.
- Do not touch the door during a cycle as the door can become hot.
- When 90°C temperature is selected, the door glass will become hot. Do not touch the glass part of the door. Keep children away from the washer.
- Do not touch or operate the machine with wet hands or with bare-feet.
- Do not open the detergent dispenser during the cycle as hot water may come out of it.
- Cleaning and user maintenance shall not be made by children without supervision.

SAFETY AND WARNINGS

- Read and follow the detergent manufacturer's instructions carefully. Instructions on how to use the detergent will be clearly indicated on the pack. Remember to store your detergents out of the reach of children.
- Do not wash an electric blanket in your washer unless the care label specifically states it is safe to do so.
- Do not wash curtains in this washer, as sunlight makes them brittle and they may disintegrate during washing.
- The only user-removable parts of the washer are the inlet hose(s), dispenser drawer and pump filter. No other parts are designed to be removed by anyone other than a Fisher & Paykel trained and supported service technician.
- Do not overload your washing machine beyond its rated capacity.

MODEL CODE	MAXIMUM CAPACITY* (KG)
WM1490P2	9kg

*Capacity refers to the maximum dry weight of items the washer can wash at any one time

Disposal

- When disposing of the washer, it is recommended that the door is removed to avoid children getting trapped inside, and that the electrical cable is cut off close to the washer.

SAFETY FEATURES

Keylock

KEYLOCK can be used to lock the buttons on your washer when not in use. This will avoid accidental button pushes. Refer to 'Control panel' for more information.

Add a Garment

The **ADD A GARMENT** button can be used to interrupt the cycle to add or remove a garment at any time during the wash part of the cycle (provided the wash temperature selected is lower than 60°C). Water in the washer will be drained to a level where the door can be opened, if necessary. Refer to 'Control panel' for more information.

Drum light

Your washer has a drum light to help assist you when loading and unloading your washer. When you press **POWER** , the LED light in the drum will turn on. At the end of the cycle, the drum light will turn on again for five minutes to help facilitate unloading.

Door lock

The door of your washer will lock when you press **▶||** and will stay locked until the washer beeps at the end of the cycle, ensuring safety for you and your family while your washer is operating.

To unlock the door during a cycle



You can open the door to add or remove items during the wash by pressing **▶||**.

The door will remain locked if the temperature inside the washer is above 60°C and/or the water level is above the bottom of the door seal (a warning will be displayed in these circumstances).

Your washer also has the following protective measures:

- Flood protection – turns off valves and turns pump on if a flood condition is detected.
- Out-of-balance protection – stops and redistributes the load if an unbalanced load condition is sensed, and/or slows the spin speed to compensate.
- Excess suds protection – pauses to allow suds to break down before continuing the cycle.

SAFETY FEATURES

Opening the door during a power failure

Do not attempt to do this if the water level in the washer is above the bottom of the door. If there is a power failure during a wash cycle your washer will stop and the door will remain locked.

1

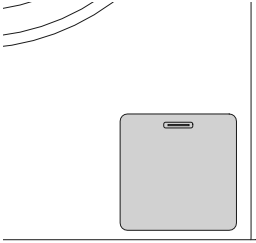

Locate the pump filter cover at the bottom right of your washer.

2

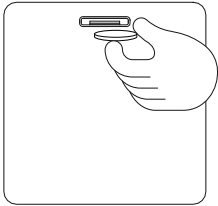

Place a coin or key in the slot and tilt it upwards to lever the cover open.

3

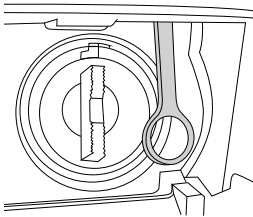

Pull the door release tab down from the ring. Use a screwdriver tip, pen or key to get a good grip.

When power is restored, your washer will resume the interrupted wash cycle. If the cycle doesn't resume automatically, simply press **POWER** ① to restart your washer.

CONTROL PANEL

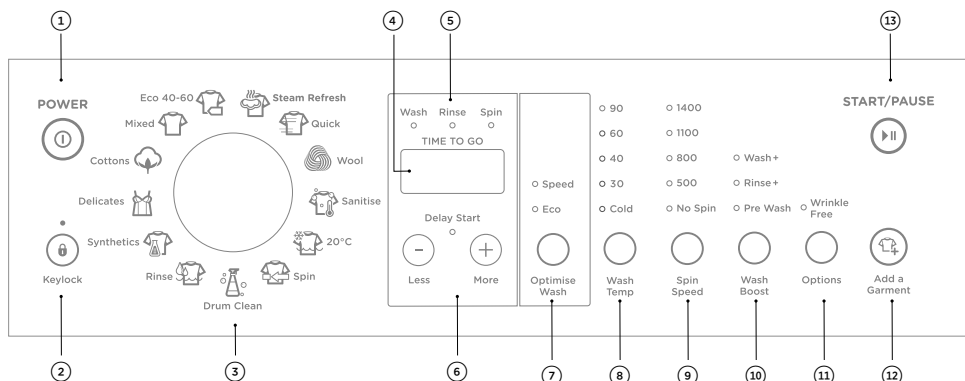

① Power	Press to turn the washer ON/OFF .
② Keylock	Press to disable all buttons on the control panel, except the POWER button. This prevents accidental button presses.
③ SmartTouch™ Control Dial	Rotate to select your desired wash cycle. <ul style="list-style-type: none"> Icon of the selected wash cycle will illuminate.
④ Digital display screen	Shows the following: <ul style="list-style-type: none"> TIME TO GO – the remaining time in the cycle that is currently running. Delayed start time of wash cycle. Notifications if an error is detected or a warning is necessary.
⑤ Progress lights	Indicate the current status of the wash cycle. <ul style="list-style-type: none"> All lights are illuminated at the start of the wash cycle. The light of the current status flashes, and then turns off once completed.
⑥ Delay Start Less/More	Press MORE + to increase and LESS - to decrease the delay start time.
⑦ Optimise Wash	Press to select ECO or SPEED .
⑧ Wash Temp	Press to increase or decrease wash water temperature.
⑨ Spin Speed	Press to increase or decrease spin speed.
⑩ Wash Boost	Press to select PRE WASH , RINSE+ or WASH+ .
⑪ Options	Press to select WRINKLE FREE .
⑫ Add a Garment	Press to interrupt the wash part of the cycle to add or remove items.
⑬ Start/Pause	Press to start or pause the selected wash cycle.

CONTROL PANEL

Add a Garment

Enables you to add or remove items during the wash stage of the cycle, under certain conditions.

1



Press  **ADD A GARMENT**, wait until you hear the door unlock.

2





Open the door and add or remove items. Close the door and press  to restart the cycle.

Keylock



To turn **KEYLOCK ON** or **OFF** when the washer is powered on:



Press  for three seconds. When activated,  is illuminated.

To turn your washer on if **KEYLOCK** is **ON** and the washer is powered **OFF**:





Press **POWER** , then press and hold  for three seconds. This will activate the control panel. Wash cycles and options can now be selected.

If a button is pressed while **KEYLOCK** is activated, beeps will be heard and  will flash.

CONTROL PANEL

If **KEYLOCK** is **ON** and you want to pause your washer:



To pause your washer at any time during the cycle, press and hold  for three seconds then press .

If **KEYLOCK** is **ON** and you want to power **OFF** your washer at any time:



Press **POWER** .

WASH CYCLES

Your washer has a number of wash cycles to suit your laundering needs. Selecting the most appropriate cycle for each particular wash load will help ensure you get the best wash result.

The most energy efficient cycles are those that perform at lower temperatures and longer duration.

CYCLE	SUB-CYCLE	DESIGNED FOR	MAX. LOAD SIZE (kg)	WASH TEMP (°C)	SPIN SPEED (rpm)
Eco 40-60¹	n/a	A cycle for normally soiled cotton items that are washable at 40°C or 60°C, as per the care label. These items can be washed together in the same cycle	9	40	1400
Mixed	n/a	A faster cycle designed for mixed loads with normal soil	9	30 (Cold-60)	1100 (0-1400)
Cottons	n/a	A cycle for normally soiled cotton garments	9	40 (Cold-90)	1400 (0-1400)
Delicates	n/a	A gentle wash with more water to care for lightly soiled delicate garments	4	30 (Cold-40)	500 (0-800)
Synthetics		A normal wash action for your everyday synthetics and poly-cotton blends	4	40 (Cold-60)	1100 (0-1100)
Rinse	n/a	Items that require rinsing and spinning	9	Cold	1100 (0-1400)
Drum Clean	n/a	An extra hot cycle designed to clean your washer	n/a	90	1400 (1400)
Spin	n/a	Spinning wet items	9	n/a	1100 (500-1400)
20°C	n/a	A cold concentrated wash with a fast spin	9	Cold (Cold)	1100 (0-1400)
Sanitise	n/a	An extra hot concentrated wash with multiple rinses	9	75	1100 (0-1400)
Wool³	n/a	An extra gentle wash action for machine washable woollen items that complies with Woolmark Apparel Care criteria	2	40 (Cold-40)	800 (0-800)
Quick	Quick 15²	A cycle for freshening up of new or very lightly soiled garments	2	30 (Cold-30)	800 (0-1400)
	Quick 30 (default)	A cycle for cleaning lightly soiled loads quickly	4	30 (Cold-30)	800 (0-1400)
Steam Refresh	n/a	A cycle designed to remove creases and light odours from up to two shirts	2 shirts	n/a	n/a

WASH CYCLES

¹**ECO 40-60** cycle is recommended for cleaning normally soiled cotton laundry, declared to be washable at 40°C and 60°C together in the same cycle. This programme is used to assess compliance with the ecodesign and energy labelling legislation. This programme is the most efficient in terms of energy and water consumption for washing cottons.

²To select **QUICK 15**, turn the dial to **QUICK** and select **SPEED** mode under **OPTIMISE WASH**.

³**Woolmark Apparel Care**

The wool wash cycle of this machine has been approved by The Woolmark Company for the washing of machine washable wool products, provided that the products are washed according to the instructions on the garment label and those issued by the manufacturer of these washing machines M1528.

The Woolmark symbol is a certification mark in many countries.



DETERGENT AND SOFTENER

Detergent

Your washer requires low-sudsing detergent to prevent oversudsing problems. Low sudsing detergent comes in powder or liquid and is labelled front loading, low suds, high efficiency or HE. Using top loader detergent in your front loader washer may lead to excessive suds formation, which will lengthen the cycle time as the washer waits for the suds to dissolve. The same detergent can be used for all cycles and temperatures.

Do not overfill the detergent compartment. Too much detergent could result in water and detergent spilling onto the floor.

Make sure that the dispenser is completely closed before starting the cycle. Do not open it again until the cycle is complete and the washer has stopped spinning.

If using liquid detergent ensure the liquid detergent compartment is installed.

If using powder ensure the liquid detergent compartment has been removed.

How much detergent?

Follow the instructions on the back of the detergent packet or bottle as a guide to the correct amount of detergent to use. The correct amount of detergent will vary, depending on level of soiling and size of load. Jeans and work clothes may need more detergent, while towels usually need less. The larger your load, the more detergent you may have to add.

Detergent advice

Add the detergent BEFORE starting the cycle, close the dispenser and do not open it while the cycle is running. If you find foam leaking from your washer, check you are using a low sudsing or front loader type detergent and check the quantity you are using against the detergent manufacturers recommendation. You may need to reduce the amount you are using.

Fabric softener advice

- Use it sparingly. Measure it carefully and do not use more than 25ml (1/2 cap), some thicker varieties may need diluting.
- Clean your dispenser regularly.
- Clean your washer regularly using the **DRUM CLEAN** cycle.
- Complete wash cycles at a wash temperature of 40°C or above at regular intervals (eg every fifth wash) as washing in cold water increases the chance of a waxy build-up occurring.

Waxy build-up can occur within any washer when fabric softener comes in contact with detergent. This build-up is not brought about by a fault in the washing machine. If allowed to build up in the washer it can result in stains on clothes and an unpleasant smell in your washer.

DETERGENT AND SOFTENER

Where to put the detergent

Pods

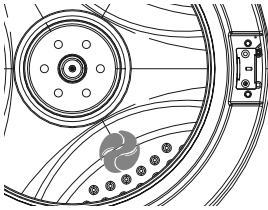

Detergent pods are a no mess alternative to powdered or liquid detergent. They must be placed at the back of the drum prior to loading your clothes. This will ensure they are activated quickly in the wash. Do not place pods in the detergent dispenser drawer or on top of your clothes.

Pre Wash

When you select **PRE WASH**, the pre wash compartment is flushed at the start of the cycle. For more information refer to 'Wash cycle options'. **PRE WASH** will not be available if the **ECO/ECO RINSE** option has been selected.

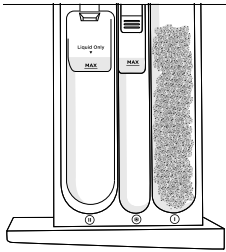

If you wish to use the **PRE WASH** option, liquid or powdered detergent only must be placed in the pre wash detergent compartment on the right side of the drawer, marked with a **I**.

Liquid detergent

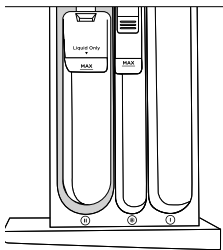

Detergent is added to the main wash compartment on the left side of the dispenser drawer marked with a **II**.

As the washer fills, water is flushed into this compartment and is mixed with the detergent, the detergent solution is then delivered into the drum. There may be a small volume of water left in the liquid detergent dispenser at the end of the cycle. This is normal.

DETERGENT AND SOFTENER

Powdered detergent

If you wish to use powdered detergent, the liquid detergent compartment **MUST** be removed from the dispenser drawer.

1

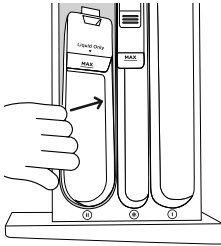

To remove the liquid detergent compartment, firmly grasp and twist the left hand side of the internal compartment and pull upwards.

To replace the liquid detergent compartment

1

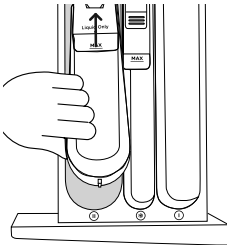

Slide it back into the drawer marked ②.

2

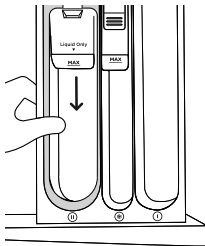

Press down in the middle until it clicks back into place.

Where to put the fabric softener

1

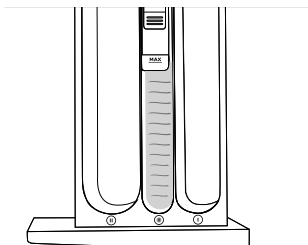

Add fabric softener to the middle compartment of the dispenser marked with a .

Fabric softener should not be used if you have selected the **STEAM REFRESH** or any **QUICK** cycle. The washer will automatically flush the fabric softener during the rinse part of the cycle.

WASH PREPARATION

Sorting

Sort items according to colour, fabric type, and soil type. Wash fine, delicate fabrics separately from thick, heavy fabrics. Always separate coloured items from whites, especially when they are new. Colour run could be an issue if you wash items at higher temperatures. Some soils, like mud and blood are best washed in cold water. Oily soils (eg some foods and marks on shirt collars) are best washed in warm water. The care label will advise on how the garment should be washed.

Before you load

- Check pockets for items that could damage your clothes or get caught in the washer.
- Close zippers, hooks and eyes, and other fastenings (ie fasten the opening of duvet/ doona covers), and remove loose bra wires. All these can damage both your washer and your clothes.
- Place delicate items, such as lingerie, in a mesh laundry bag before placing in the washer.
- Pre-treat any stains, taking care not to spray pre-treaters on your washer as they can cause damage to the plastic surfaces.

Loading

Your washer will be more efficient when washing larger loads, try to fill your washer to the maximum load size for the cycle selected (refer to 'Wash cycles').

WASH PREPARATION

ITEMS/WASH REQUIREMENTS	SUGGESTED CYCLE AND OPTIONS	SUGGESTED TEMPERATURE
Towels	Cottons, 1400 or 1100 rpm spin	30°C or 40°C
Sheets, pillowcases	Mixed, 1400 or 1100 rpm spin	30°C or 40°C
Bulky items – doonas, duvets, sleeping bags	Delicates, 800rpm	30°C or 40°C
Shirts, pants, other creasables	Synthetics	30°C or 40°C
Woollens	Wool, 500 rpm	30°C or 40°C
Delicate garments – blouses & dresses	Delicates	30°C
Extra delicate fabrics like lace	Delicates	30°C
Silk garments	Delicates	30°C
Jeans	Mixed	Cold or 30°C
Highly coloured items	Mixed	Cold or 30°C
Whites, cotton items	Cottons, 1400 or 1100 rpm spin	40°C or 60°C
Sensitive skin or extra rinsing requirements	Cottons, Rinse+	40°C
Asthma/allergies	Cottons, Rinse+	60°C
Handkerchiefs, nappies, bedding and facemasks	Sanitise	75°C
Lightly soiled items	Quick – Quick 30 or 15	30°C
Muddy, sandy or linty items	Mixed, Pre wash and/or Rinse+	Cold
Unpleasant odour in the washer drum	Drum Clean	90°C
Items made of blended fibres (eg polyester cotton)	Mixed	40°C
Heavily soiled items	Mixed, Pre wash and/or Rinse+	40°C

GETTING STARTED QUICKLY

1

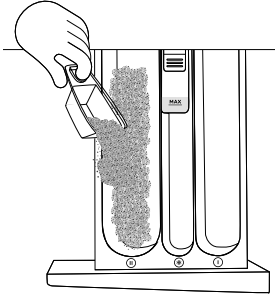

Open the detergent drawer.

Pour liquid or powder detergent in the draw or place the pod in the drum.

Pre-dissolving detergent in warm water when washing can improve the performance of the liquid and powder detergent.

2



Press ① to activate your washer.

3



Select your desired wash cycle by turning the Control Dial. The wash cycle icons will illuminate as you turn the dial showing which cycle is selected, along with the default wash cycle settings.

4

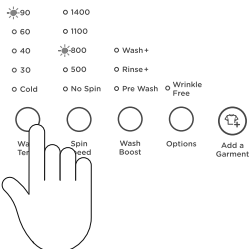

Customise your wash as needed by selecting specific temperature and spin speeds. Refer to 'Wash cycle options' for more information.

GETTING STARTED QUICKLY

5



Press ►|| to start the cycle. The washer will start to fill with water and select the correct wash action for your load.

6



Use  to lock the buttons on the control panel, preventing them from being activated accidentally by a washing basket or little fingers. Refer to the 'Wash cycle options' section.

For best fabric and colour care, remove your clothes as soon as the cycle has finished. Failure to follow the advice in this guide may result in damage to your garments and your expectations of wash performance may not be met.

CUSTOMISING A WASH CYCLE

Delay Start

You can delay the start of the wash cycle between 15 minutes and 12 hours. This can be useful to time your washing to finish when you arrive home from work, or to start once you have finished in the shower.

1

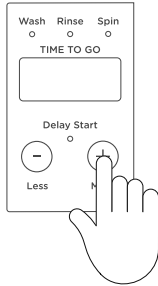

Press **MORE +** to increase the delay time, and **LESS -** to decrease the time, or turn **DELAY START** off.

2



Press **▶||** to confirm your selection and start the countdown. The display screen will show the time until the cycle is set to begin.

Avoid using **DELAY START** for damp, non-colourfast items as this may cause dye run to occur.

CUSTOMISING A WASH CYCLE

Wash Temp

Your washer has five wash temperatures (COLD, 30°C, 40°C, 60°C and 90°C).

Some temperatures are not available on some cycles as a safeguard for your clothes (eg temperatures above 40°C on the DELICATE cycle).

The washer will fill with both hot and cold water (if possible) to achieve the selected wash temperature. If required, ie for cold supply or cold connection only, the washer will heat the water to the selected temperature.

1

<input type="radio"/> 90	<input type="radio"/> 1400	
<input type="radio"/> 60	<input type="radio"/> 1100	
<input type="radio"/> 40	<input type="radio"/> 800	<input type="radio"/> Wash+
<input type="radio"/> 30	<input type="radio"/> 500	<input type="radio"/> Rinse+
<input type="radio"/> Cold	<input type="radio"/> No Spin	<input type="radio"/> Pre Wash

Wash Temp Spin Speed Wash Boost

Press the **WASH TEMP** button to increase or decrease the wash temperature.

Spin Speed

Your washer offers five spin speeds: 500 rpm, 800 rpm, 1100 rpm and 1400 rpm, **NO SPIN**.

Higher spin speeds will reduce the remaining moisture in the load, but may increase noise.

1

<input type="radio"/> 90	<input type="radio"/> 1400	
<input type="radio"/> 60	<input type="radio"/> 1100	
<input type="radio"/> 40	<input type="radio"/> 800	<input type="radio"/> Wash+
<input type="radio"/> 30	<input type="radio"/> 500	<input type="radio"/> Rinse+
<input type="radio"/> Cold	<input type="radio"/> No Spin	<input type="radio"/> Pre Wash

Wash Temp Spin Speed Wash Boost

Press **SPIN SPEED** to select the required spin speed for your load.

2

<input type="radio"/> 90	<input type="radio"/> 1400	
<input type="radio"/> 60	<input type="radio"/> 1100	
<input type="radio"/> 40	<input type="radio"/> 800	<input type="radio"/> Wash+
<input type="radio"/> 30	<input type="radio"/> 500	<input type="radio"/> Rinse+
<input type="radio"/> Cold	<input checked="" type="radio"/> No Spin	<input type="radio"/> Pre Wash

Wash Temp Spin Speed Wash Boost

Selecting **NO SPIN** will end the cycle after the rinse, allowing you to remove items you wish to drip dry.

The washer will complete the spins that are within the wash and rinse portions of the cycle; only the final spin will not be completed.

CUSTOMISING A WASH CYCLE

Optimise Wash

Your washer offers two optimise wash modes – **ECO** and **SPEED** – allowing you to save water and energy or save time. For clothes care reasons not all options are available on all cycles.

Eco

Use **ECO** mode to save water and energy. Selecting **ECO** will reduce the wash temperature slightly and alter the wash and rinse programming.

- **SPEED** and **ECO** cannot be selected together.
- **ECO** will not be available if **PRE WASH** or **RINSE+** have been selected.

Speed

A special feature designed to offer a shorter cycle whilst maintaining wash performance. This mode can be selected on **COTTONS**, **SYNTHETIC**, **20°C** and **QUICK** cycles. A number of factors can influence the amount of time saved on a cycle, including the load size, cycle chosen, water flow rate and load distribution during spin.

Pre Wash

Your washer will start with a short wash in cool water to remove excess soil. The washer will drain and then fill at the selected temperature for the main wash. **PRE WASH** cannot be selected after a wash cycle has been started or if **ECO** has been selected. Use liquid or powdered detergent in the **PRE WASH** compartment. The compartment is flushed at the start of the cycle.

Rinse+

If you have a particularly dirty load, or you have sensitive skin and wish to give your clothes an extra rinse, select **RINSE+** from the **WASH BOOST** options. Your load will undergo an extra rinse to get rid of any residual detergent or soil in the items.

RINSE+ will not be available if the **ECO** option has been selected.

Wash+

WASH+ allows you to increase the wash time for heavy soiled items. The increase in wash time gives the load the right amount of tumbling to remove the soil from items that might need it.

Options

Wrinkle Free

We recommend you remove the clothes from the washer immediately after the completion of the cycle to minimise wrinkling and creasing of items and to prevent dye run. However, if you will not be present at the end of the wash you can select **WRINKLE FREE**.

When **WRINKLE FREE** is selected, the washer will tumble the clothes once every 15 minutes for up to 12 hours after the cycle has finished. The **WRINKLE FREE** light and ►|| button will flash, and the washer will beep at regular intervals to remind you to remove your load. To remove the load during this phase, simply press the ►|| button.

CUSTOMISING A WASH CYCLE

To save a customised cycle

You can program your washer to remember the wash options you prefer for each wash cycle. For instance, you may want to set the **MIXED** cycle to default to **40°C** or set the **COTTONS** cycle to include **WASH+**, **RINSE+** or **WRINKLE FREE**.

1



Press **POWER** ① to activate your washer.

2



Turn the dial to select the wash cycle you wish to customise, eg **MIXED**.

3

- 90
- 60
- 40
- 30
- Cold
- 1400
- 1100
- 800
- 500
- No Spin
- Wash+
- Rinse+
- Pre Wash

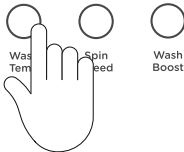

Press and hold the button of the option you want to customise, eg **WASH TEMP**, for three seconds. You will hear two quick beeps and the wash cycle icon will flash. The screen will display **SET**.

CUSTOMISING A WASH CYCLE

4



Select your preferred setting for the option, then press  to save. A long beep will sound to confirm that your changes have been saved.

5

- 90
- 1400
- 60
- 1100
- 40
- 800
- Wash +
- 30
- 500
- Rinse +
- Cold
- No Spin
- Pre Wash



Wash
Temp



Spin
Speed



W/
Bd

Continue to select any other options you wish to customise for this cycle. Press  to save your customised cycle.

To change your customised wash cycle simply repeat these steps.

CHANGING PRE-SET OPTIONS

Option Adjustment mode

This allows you to change the **CONTROLLED COLD** default setting wash temperature to **COLD TAP**. If your incoming cold water temperature is very low and you choose to do a **COLD TAP** wash, the wash may be less effective.

To enter Option Adjustment mode:

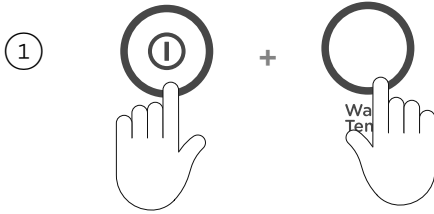

Turn your washer on at the wall but do not press **I**.

Press and hold the **I** and **WASH TEMP** buttons together for three seconds. You will hear a quick beep and **SET** will appear on the screen indicating you have entered option adjustment mode.

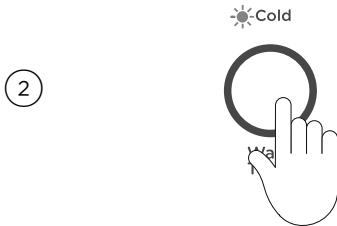

The cold **WASH TEMP** icon will flash on and off. This is the default setting, where the machine uses the internal heater to heat the water to 20°C.

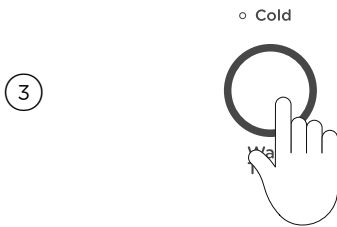

Press the **WASH TEMP** button once, the cold icon will stop flashing, indicating that the temperature of the water will now be the same as the incoming water from the cold supply.

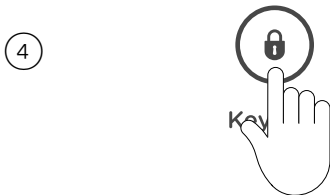

Press **Key** to save the setting.

Your washer will automatically remember your changes for all future washes you do on this cycle.

If you always use **COLD** or **CONTROLLED COLD** water, we recommend that a warm or hot wash be used regularly, eg every fifth wash should be at least 40°C or above. Warm water is needed to help maintain the cleanliness of your washer.

FACTORY RESET

You can reset your washer to factory default settings by following the steps below.

To reset your washer to factory default settings:



Select the **SPIN** cycle.

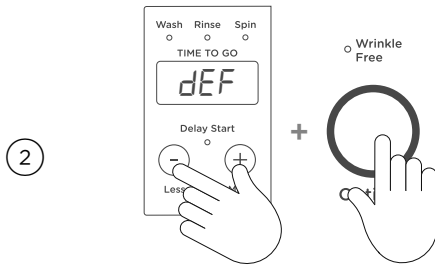

Press **MORE +** , **LESS -** and **OPTIONS** buttons together for three seconds, **dEF** will appear on the screen and the washer will beep.

Your washer will now be reset to factory default settings.

CARING FOR YOUR WASHER

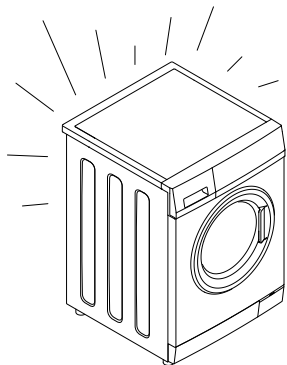

When you have finished using your washer

- Turn off the taps to prevent the chance of flooding should a hose burst.
- Unplug the washer from the power socket.

Cleaning your washer

Before you start cleaning your washer, ensure that it is disconnected from the power (ie unplug the washer from the power socket).

Aside from the detergent dispenser, water hose(s), and the pump filter, no other parts are designed to be removed from the washer for cleaning. Do not attempt to remove any other part of the washer.

Cleaning the control panel and outer surfaces of the washer

Use a soft damp cloth to wipe all surfaces, and wipe dry. Avoid using chemical or scouring cleaners, as these will damage the paint and plastic surfaces of your washer.

Cleaning the dispenser drawer

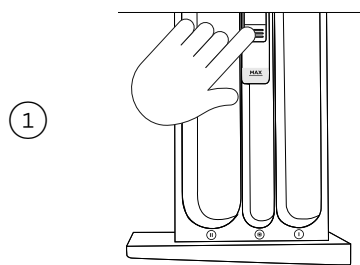

To remove the dispenser drawer from the washer, pull the dispenser drawer open, push down on the tab on the top of the fabric softener compartment and pull the dispenser drawer out from the washer.

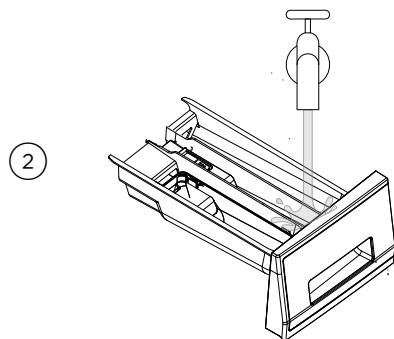

To clean the dispenser drawer, fill the compartments with warm water and shake lightly to clear residue.

Use a descaling agent and brush to remove stubborn residue and limescale.

Drain all water from the compartments before re-fitting the dispenser drawer to the washer.

CARING FOR YOUR WASHER

Cleaning the drum and the door

- Use a soft damp cloth to wipe the door, cleaning any water marks or residue off it.
- Wipe the rubber seal around the door. Remove any items or lint accumulating in the bottom of the seal catchment and wipe out any water accumulated here. If this is not cleaned out, unpleasant odours will develop.
- If the drum has any residual dirt or lint stuck to it, remove this and wipe the drum clean. Do not leave any metal objects in the drum as these may rust and cause staining.

Leave the door to your washer open when it is not in use to allow the washer to dry out, otherwise it will develop unpleasant odours. When leaving the door open like this, it is extremely important that children and pets are kept away from the washer so they cannot be accidentally trapped inside it.

Cleaning the hose(s)

Each hose has a filter in it, preventing any solid contaminants in the water entering your washing machine. Occasionally you should disconnect the water inlet hose(s) where they connect to the tap(s), check these for any build up of dirt and wash this out.

CARING FOR YOUR WASHER

Cleaning the inside of your washer

It is important that you regularly clean the inside of your washer using the **DRUM CLEAN** cycle. After 100 cycles, a notification will pop up on the display screen to remind you to clean your washer.

If your washer starts to smell this is a sign that you should complete a **DRUM CLEAN** cycle. We recommend that you do not have any items in the washer when you run this cycle.

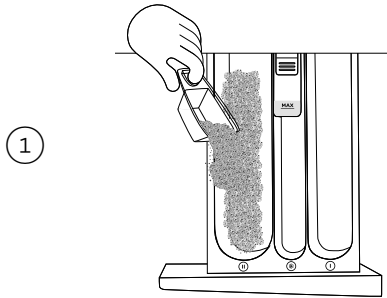

Add the washing machine cleaner directly into the **MAIN DETERGENT COMPARTMENT**. Follow the manufacturer's instructions.



Press **POWER** ① to turn your washer on and select the **DRUM CLEAN** cycle.



Press **▶||** to start the cycle.

CARING FOR YOUR WASHER

Cleaning the pump filter

The pump filter must be checked and cleaned at least every 6 months.

1

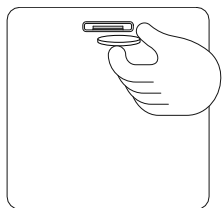

Turn the power off and unplug the washer.
Use a coin to open the filter cover, place the edge of the coin into the slot and tilt upwards whilst levering the cover open.

2

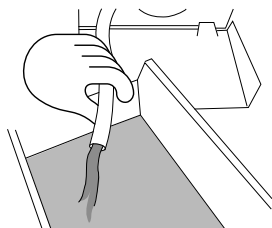

Unhook the pump outlet hose and pull it out (approximately 150mm). Remove the plug and allow any water (approximately 250ml) to drain into a shallow dish.

After the draining process is complete, replace the plug into the hose and refit the hose back into the housing.

3

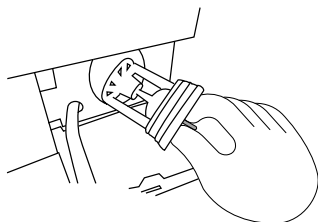

Remove the filter by turning anti-clockwise. Clean and rinse under a tap. Check the pump filter cavity for any further obstruction. Check that the impellor located at the back of the cavity moves freely.

4

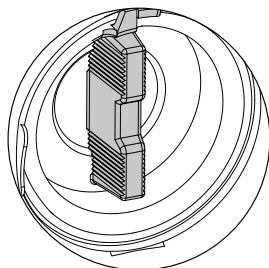

Replace the filter by turning clockwise until the turning handle stops in the vertical position, and cannot be turned further.

CARING FOR YOUR WASHER

Products that might damage your washer

- Concentrated bleaches, laundry pre-soakers/sanitiser, stain removers and hydrocarbon solvents (eg petrol and paint thinners) can cause damage to the surfaces, eg control panel, and components of your washer.
- Be careful when washing garments stained with solvents as they are flammable. DO NOT put them in your dryer.
- Use of dyes in your washer may cause staining of the plastic components. The dye will not damage the washer but we suggest you thoroughly clean your washer afterwards. We do not recommend the use of dye strippers in your washer.
- Nappy sanitiser and bleach are very corrosive to metal surfaces. DO NOT tip the contents of a nappy bucket into your washer. Rinse and wring items out thoroughly before placing them in the washer.

Moving your washer

Make sure any water in the washer is drained out. This can be done by cleaning out the pump filter, refer to 'Cleaning the pump filter'.

Saving water, energy and the environment

Water efficient washing machines will save you money, but it is also worth thinking about energy use, recycling water and the environment. Some options to consider are:

- Turn the washer off at the wall when not in use.
- Turn off the taps when not in use.
- Select cooler wash temperatures.
- Wash full loads rather than several smaller loads.
- Use the **ECO** wash function (where available).
- Follow instructions on the detergent packet or bottle – do not overdose.
- Use concentrated detergent – it costs less per wash.
- Consider re-using the washing machines grey water on the garden or for flushing your toilet – more information can be found on [government websites promoting energy and water saving](#).

BEFORE YOU CALL FOR SERVICE

User warnings

Your washer is capable of self diagnosis and may sound a series of beeps and display a notification or warning to inform you when there is a problem. In most cases you will be able to address the problem the washer is alerting you to. Check this chart before you call for service.

PROBLEM	DISPLAYED AS	WHAT TO DO
Keylock is activated	KEY LOC	Press and hold  for three seconds.
Pump filter is blocked	CLF FLTR	Clean the pump filter.
The washer is not getting any water	n0 ERP	<p>Check the tap(s) have been turned on.</p> <p>If there is no hot water connection the washer will heat the water itself, but there must be a cold water connection to the cold valve.</p> <p>Check the hose connections. If the cold water supply is connected to the hot valve and there is no connection to the cold valve the washer will not fill.</p> <p>Check the inlet hose(s) filters are not blocked, the hose(s) are not kinked and are attached correctly.</p> <p>Check that the drain hose is not too low or pushed into the standpipe too far. This will cause the water to siphon out of the washer.</p> <p>Check that the cold water temperature does not exceed the 35°C temperature requirement.</p> <p>Check the water flow rate. It maybe too low.</p>
The washer is out of balance	out OF BAL	<p>The wash load has gone out of balance at some point during the cycle. Press ► to stop the message. You may notice the load feels wetter than usual, as the washer has adjusted the spin speed to compensate for the out of balance. If you want to improve the dryness of the load, manually re-distribute the load and remove items if necessary. Close the door, adjust the spin speed if necessary and press ► to start the washer.</p> <p>Check the washer is level.</p>

BEFORE YOU CALL FOR SERVICE

PROBLEM	DISPLAYED AS	WHAT TO DO
The washer has too many suds	<i>Sud LOC</i>	<p>Washer will stop and flash <i>Sud LOC</i> while waiting for suds to dissipate. The washer will not beep during this time. When the suds have dissipated the washer will automatically restart. If a suds event has occurred during a cycle the washer will also display this warning at the end of the cycle, to alert you that this has occurred. This may help to explain any reduction in performance.</p> <hr/> <p>Check you are using a detergent suitable for front loaders.</p> <hr/> <p>Check you are not overdosing the detergent.</p> <hr/> <p>Check the standpipe height for the drain is a minimum of 600mm.</p>
Door is locked	<i>door Locd</i>	<p>The temperature in the drum is over 60°C therefore it is not safe to open the door. Wait until the temperature drops below 60°C.</p> <hr/> <p>Check the water level in the drum. If the level is above the bottom of the door seal, the door cannot be opened. Use the ADD A GARMENT button if you wish to add or remove items</p> <hr/> <p>If the drum is still moving, wait for it to stop before attempting to open the door.</p>
Door is open	<i>door OPEN</i>	<p>Close the door fully and press ►II.</p> <hr/> <p>Try opening and closing the door again.</p> <hr/> <p>Reposition the load, make sure the load is correctly in the drum and that protruding items are not stopping the door from closing.</p>

FAULT CODES



If a continuous series of beeps sounds, all the lights turn off on the control panel and a number appears on the display, a fault has occurred. The washer automatically enters this mode when there is a fault. The word **ERR** will be shown in the control panel display followed by a number (refer to example shown here). To stop the beeps, touch any button then perform the following steps:

- ① Turn your washer off at the power point.
- ② Wait one minute and turn it back on.
- ③ Check your washer is correctly levelled. Refer to your installation guide.
- ④ Remove your wash load.
- ⑤ Perform a **RINSE** cycle.
- ⑥ If the fault re-occurs repeat steps ① and ②.
- ⑦ If the washer will still not work you will be required to call a Fisher & Paykel trained and supported service technician to arrange service, refer to 'Customer Care' for details. Record the fault code number displayed and the serial number of your washer (located above the door opening when the door is open) before calling. The fault code will indicate to the repairer what the problem could potentially be.

If a fault code is being displayed, you can still turn your washer off by pressing **POWER** ① .

TROUBLESHOOTING

The following is a list of problems you may encounter when using this appliance and some suggestions that may help to correct the problem. If you still have problems, contact your Fisher & Paykel trained and supported service technician.

PROBLEM	POSSIBLE CAUSES	WHAT TO DO
Washer not turning on	Power not switched on at the wall.	Switch the power on at the wall. Press POWER  .
	Household power supply not working.	Try plugging in another electrical appliance.
Pressing ► does not start the fill	Keylock may be activated.	Press and hold  for three seconds.
	Washer door not closed properly.	Open and reclose door.
	The washer has detected a fault.	Check if a code is being displayed on the control panel, refer to 'Fault codes'.
	Hot and cold taps not turned on.	Check that both hot and cold taps are turned on (if using cold inlet only ensure inlet valve cap is installed on the hot valve on the washer).
	Hot and cold taps not connected to the corresponding valve on the washer.	Check the cold tap is connected to the cold valve on the washer and the hot tap is connected to the hot valve.
	Blocked hose filters.	Check the tap end of the inlet hose(s) for blockages.
	Inlet hose(s) leaking, twisted or damaged.	Check the inlet hose(s) for leaks or damage. Check that the inlet hose(s) are not twisted.
	Faulty water supply.	Check tap(s) that aren't connected to the washer are working.
Washer stops working mid cycle	Delay start maybe set.	Refer to 'Delay Start'.
	The washer has detected a fault.	Refer to 'User warnings' or 'Fault codes'.
	Power or water failure.	Check the power and/or water is working correctly.
	Washer has been paused.	Press ► to continue.
Washer drains while filling	Oversudsing.	Washer is waiting for suds to dissolve before continuing the cycle.
	Drain hose too low.	Ensure the height of the drain hose is at least 600mm from the floor level, refer to your installation guide.
	Drain hose sitting in water.	Clear the drain.

TROUBLESHOOTING

PROBLEM	POSSIBLE CAUSES	WHAT TO DO
Washer is not draining	Drain hose blocked.	Clear the drain hose.
	Pump filter blocked.	Clear the pump filter, refer to 'Cleaning the pump filter'.
Filling continuously	Drain hose higher than 1000mm above floor level.	Lower the level of the drain hose, refer to your installation guide.
	Drain hose not connected to standpipe, tub or spigot.	Connect drain hose correctly, refer to your installation guide.
Poor rinsing	Washer is siphoning.	Ensure standpipe or tub is at least 600mm from the floor level.
	Incorrect detergent used.	Use low sudsing, front loader detergent only.
Not spinning properly	Too much detergent used.	Ensure the correct dose of detergent is used for the load size and soil level refer to 'Detergent and softener'.
	Load has gone out of balance.	The wash load has gone out of balance during the spin. If you want to improve the dryness of the load, manually re-distribute the load and remove items if necessary. Close the door and select the SPIN SPEED , adjust the spin speed if necessary and press ► to start the washer.
Too many soap suds	Suds build up.	Check the amount of detergent used, reduce if necessary.
	Incorrect type of detergent used.	Use low sudsing, front loader detergent only refer to 'Detergent and softener'.
Small puddle of water from under the washer	Too much detergent used.	Ensure the correct dose of detergent is used for the load size and soil level refer to 'Detergent and softener'.
	Inlet water pressure/ flow rate too low.	Ensure correct inlet water pressure and flow rate as per the installation guide.
Small puddle of water from under the washer	Inlet hose(s) or drain hose leaking.	Check inlet hose(s) and the drain hose are correctly attached and not damaged.
	Lots of suds.	Suds may have leaked and then dissolved.
	Dispenser compartments blocked.	Refer to 'Cleaning the dispenser drawer'.
	Dispenser drawer not fully closed.	Close dispenser drawer fully and ensure it remains closed during the cycle.
	Damage to door seal.	Check seal inside door for damage. If it sustains any damage it will need to be replaced.

TROUBLESHOOTING

PROBLEM	POSSIBLE CAUSES	WHAT TO DO
Cycle time longer than usual / inaccurate adjustment of time remaining during cycle	Cycle time is approximate.	Cycle time is influenced by a number of factors refer to 'Wash cycles'.
	Low water pressure or flow rate.	Ensure that inlet hose filters are not blocked.
	Out of balance or oversudsing.	Recovery from out of balance or oversudsing will extend cycle time refer to 'Caring for your washer'.
	Washing a large load.	Be aware that it will take longer for the washer to fill.
	Selecting various options.	Be aware that some options will extend cycle time.
Detergent or fabric softener remaining in dispenser at the end of the cycle	Dispenser drawer not properly closed or was opened part way through the cycle.	Ensure the dispenser drawer is fully closed at the start of the cycle and remains closed throughout the cycle.
	Dirty or blocked dispenser.	Clean the dispenser drawer. Refer to 'Cleaning the detergent dispenser drawer'.
	Liquid sitting at the MAX level at the end of the cycle indicates a blockage.	Clean the fabric softener dispenser compartment, refer to 'Cleaning the dispenser drawer'.
	Dispenser over loaded with detergent.	Clean out remaining detergent, Refer to 'Cleaning the detergent dispenser drawer'.
	Composition of the powder detergent makes it difficult to dispense.	Dissolve detergent with water to aid with dispensing.
Washing very wet at the end of the cycle	Cycle selected not appropriate.	Particularly short or delicate cycles have shorter spins which can result in wetter washing at the end of the cycle.
	Incorrect spin speed for load selected.	Select a faster spin speed.
	An out of balance load has occurred.	The washer compensates for the out of balance by using a lower spin speed, to reduce noise and potential damage to the product.
Vibrating	Transit bolts left in place.	Ensure transit bolts are removed prior to use of the washer, refer to your installation guide.
	Washer may not be level.	Ensure washer is installed on an appropriate surface and levelled correctly, refer to your installation guide.
	Load is out of balance.	Wash an average sized load rather than a smaller load or a single item. Washing one item at a time is not recommended as it is difficult for the washer to balance a single item during spin.

TROUBLESHOOTING

PROBLEM	POSSIBLE CAUSES	WHAT TO DO
Creasing	Washer overloaded.	Do not overload the washer.
	Incorrect cycle for load type.	Use the SYNTHETICS, DELICATE or STEAM REFRESH cycle for creasable items.
	Spin speed too fast.	Select a slower spin speed.
	Wet clothes left in washer or laundry basket.	Laundry left sitting wet is more likely to crease. If not removing clothes from washer immediately at the end of the cycle, select the Wrinkle Free option. Do not leave wet washing sitting in a washing basket.
	Wash temperature too hot for load type.	Select a lower wash temperature. Check items care label for correct care. Check the hot and cold taps are connected to the correct valves, refer to your installation guide.
Poor soil removal	Items not sorted correctly.	Sort load so that items of similar weight are washed together.
	Incorrect wash cycle selected.	Select a wash cycle that is appropriate for the amount of dirt, refer to 'Wash cycles'.
	Insufficient detergent.	Ensure the correct dose of detergent is used for the load size and soil level. Refer to 'Detergent and Softener'.
	Washer overloaded.	Ensure the washer is not overloaded in terms of its capacity or the cycle selected, refer to 'Loading'.
	Items require a longer wash time.	Select WASH+ or PRE WASH option.
	Load was particularly dirty.	Select the PRE WASH option for particularly dirty loads, refer to 'Customising a wash cycle'.
	Items not sorted correctly.	Wash heavily and lightly soiled garments separately.
	Washer dirty from previous wash.	After washing particularly dirty clothing, we recommend putting the washer through a RINSE cycle once the load has been removed. This washes away any remnants of dirt that could affect future wash performance.
	Incorrect wash temperature selected in relation to the type of soil.	Select a wash temperature suitable for the type of soil, eg warm for greasy soils, cold for muddy soils. Increasing the wash temperature generally improves soil removal and overall wash performance. Ensure garments can be washed at the increased temperature.

TROUBLESHOOTING

PROBLEM	POSSIBLE CAUSES	WHAT TO DO
Dye transfer	Coloured items not washed separately from white/light coloured items.	Remember to separate whites and colours.
	New or non-colourfast items not washed separately.	Wash non-colourfast items separately and select COLD wash temperature.
	Wet items have been left sitting for too long.	Remove items from washer as soon as the cycle is finished.
	Wash temperature.	Consider the wash temperature you select for your coloured items. Lower the temperature if you are concerned.
Black or grey marks on clothes	Incorrect amount of detergent.	Ensure the correct dose of detergent is used for the load size and soil level, refer to 'Detergent and softener'.
	Washer needs to be cleaned.	Empty the washer and complete a DRUM CLEAN cycle, refer to 'Cleaning the drum and the door'.
Tangling	Items not sorted correctly.	Separate larger items from smaller items.
	Washer loaded incorrectly.	Load items loosely and individually into the washer, ie not folded.
	Incorrect cycle for load type selected.	Use the SYNTHETICS or STEAM REFRESH cycle for items that crease easily.
	Overloaded in terms of its capacity or the cycle selected.	Refer to wash cycles for recommended maximum load size.
	Delicate items.	Wash pantyhose, bras and any other delicate items prone to tangling in a mesh laundry bag.
Washer smells	Not using enough detergent for the soil level in your loads.	Run a DRUM CLEAN cycle.
		Buy a better quality detergent or use a higher dose.
		Different detergents have different cleaning chemicals, consider alternating detergents to help remove odour.
Wet patches on clothes/items	Clothes are slightly damp from the steam.	It is normal for items to be damp after using the STEAM REFRESH cycle, this helps to remove the wrinkles. Remove the items from the washer immediately at the end of the cycle and hang up to dry.

ENERGY CONSUMPTION AND CYCLE TIMES

Information on product Energy Labeling and Eco-design can be found in the European Product Database (EPREL) at the following link <http://eprel.ec.europa.eu/>.

The below values are indicative only.

CYCLE	LOAD SIZE (KG)	SPIN SPEED (RPM)	REMAINING MOISTURE CONTENT (%)	MAXIMUM TEMP (°C)	ENERGY (KWH/CYCLE)	WATER CONSUMPTION (L/CYCLE)	DURATION (H:MM)
Eco 40-60	2.25	1400	64	23	0.240	32	2:53
	4.5	1400	57	31	0.570	41	2:53
	9	1400	58	30	0.730	62	3:48
Cottons	9	1400	52	60	2.043	106	2:30
Mixed	9	1100	66	30	0.470	78	0:59
20°C	9	1100	58	20	0.257	82	2:06
Quick	4	800	84	30	0.357	60	0:30

ENERGY CONSUMPTION (KWH)

Off-mode 0.49

Left-on mode 0.49

MANUFACTURER'S WARRANTY



For details of your 5 year manufacturer's warranty and contacts for servicing, please refer to your separate service & warranty document online at fisherpaykel.com/uk.

This product has been designed for use in a normal domestic (residential environment). This product is not designed for any commercial use. Any commercial use by the customer will affect this products Manufacturer's Warranty.

For spare parts, please contact Fisher & Paykel Customer Care. Spare parts are available for all Fisher & Paykel products for a minimum period of 10 years from the date of manufacture.

CUSTOMER CARE

Before you call for service or assistance

Check the things you can do yourself. Refer to your User guide and check:

- ① Your product is correctly installed.
- ② You are familiar with its normal operation.
- ③ You have read the 'Before you call for service', 'Fault codes' and 'Troubleshooting' sections.

If after checking these points you still need assistance or parts, please refer to your nearest Fisher & Paykel trained and supported service technician, Customer Care, or contact us through our website fisherpaykel.com.

In UK if you need assistance

Call the Fisher & Paykel Customer Care Centre and talk to one of our Customer Care Consultants.

Toll Free: 08000 886 605

Website: fisherpaykel.com

Postal address:

Fisher & Paykel Appliances Ltd,
Turing House, Ortensia Drive,
Milton Keynes MK17 8LX

In Ireland if you need assistance

Call the Fisher & Paykel Customer Care Centre and talk to one of our Customer Care Consultants.

Toll Free: 1800 625174 or 01 807 7960

Website: fisherpaykel.com

Postal address:

Fisher & Paykel Appliances Ltd,
Unit 2D Corporate Park,
Swords Dublin

CUSTOMER CARE

If you need service

Fisher & Paykel has a network of Fisher & Paykel trained and supported service technicians that can carry out any service necessary on your appliance. Our Customer Care Centre can recommend a Fisher & Paykel trained and supported service technician in your area. Or you can book one online at fisherpaykel.com/uk/help-and-support or fisherpaykel.com/ie/help-and-support

If you call, write or contact us via our website please provide:
your name and address, model number, serial number, date of purchase and a complete description of the problem. This information is needed in order to better respond to your request for assistance.

Product details can be found on the rear of the washer and/or above the drum, below the control panel (when the door is open).

Registration

Register your product with us so we can provide you with the best service possible. To register your product visit our website: fisherpaykel.com/register

Complete and keep for safe reference:

Model	_____
Serial No.	_____
Purchase Date	_____
Purchaser	_____
Dealer	_____
Suburb	_____
Town	_____
Country	_____

EUROPEAN DIRECTIVE 2012/19/EU ON WASTE ELECTRICAL AND ELECTRONIC EQUIPMENT (WEEE)

EU This appliance is marked according to the European Directive 2012/19/EU on Waste Electrical and Electronic Equipment (WEEE). By ensuring this product is disposed of correctly, you will help prevent potential negative consequences for the environment and human health, which could otherwise be caused by inappropriate handling of this product.

The symbol  marked on the serial plate, or on the documents accompanying the product, indicates that this appliance cannot be treated as household waste. It shall be handed over to the applicable collection point for the recycling of electrical and electronic equipment. Disposal of the appliance shall be carried out in accordance with the local environment regulations for waste disposal and ensure the refrigerant circuit is not damaged.

For more detailed information about treatment, recovery and recycling of this product, please contact your local city office, your household waste disposal service or your Fisher & Paykel retailer/dealer from whom you purchased this product.

FISHERPAYKEL.COM

© Fisher & Paykel Appliances 2021. All rights reserved.

The models shown in this guide may not be available in all markets
and are subject to change at any time.

The product specifications in this guide apply to the specific products and
models described at the date of issue. Under our policy of continuous product
improvement, these specifications may change at any time.

For current details about model and specification availability in your country,
please go to our website or contact your local Fisher & Paykel dealer.

430310A 04.21