

60cm Series 7 Contemporary Pyrolytic Oven, 9 Function

Series 7 | Contemporary

Black



With generous capacity and beautiful black Contemporary styling, this built-in oven will complement your kitchen design perfectly.

- 85L total capacity, with 9 oven functions including Pizza Bake and Roast
- Moisture level control with ActiveVent™ technology
- Pyrolytic self-cleaning function breaks down food residue for an easy clean

DIMENSIONS

Height	598 mm
Width	596 mm
Depth	565 mm

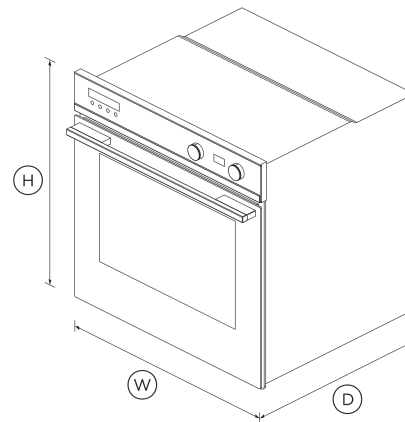

FEATURES & BENEFITS

Multi-Function Flexibility

Nine functions including Roast, Pizza Bake and Fan Grill mean no matter what you're cooking, you've got the right heat to match.

BEAUTY OF CHOICE

With the choice of stylish stainless steel or elegant black, you can choose the finish that complements your kitchen design best.

Generous capacity

With a generous-sized internal cavity, you can create several dishes at once using multiple shelves.

Activevent Technology

With ActiveVent technology for optimised moisture levels and AeroTech™ for even heat distribution, you'll get perfect results even when using multiple shelves.

Simple Cleaning

Pyrolytic self-clean breaks down food residue at a very high temperature, leaving a light ash that's easily removed with a damp cloth.

Safe And Sound

The CoolTouch door features triple glazing and a cooling system that ensures it's safe to touch from the outside - protecting both your hands and the surrounding cabinetry.

SPECIFICATIONS

Accessories (included)

Chromed shelf runners	•
Flat brushed baking tray	1
Roasting dish	1
Step down wire shelf	1
Telescopic sliding runners	1 set
Wire shelf	1

Accessories (sold separately)

Optional round handle	Part 81645
-----------------------	------------

Capacity

Shelf positions	6
Total capacity	85 L
Usable capacity	72 L

Pyrolytic self-clean	•
Roast	•

Warranty

Parts and labour	2 years
------------------	---------

Cleaning

Acid resistant graphite enamel	•
Pyrolytic self-clean	•
Removable oven door	•
Removable oven door inner glass	•

Performance

ActiveVent™ system	•
AeroTech™ technology	•
Automatic rapid pre-heat	•
Grill power	3000 W
Whisper quiet cooking	•

SKU	82145
-----	-------

The product dimensions and specifications in this page apply to the specific product and model. Under our policy of continuous improvement, these dimensions and specifications may change at any time. You should therefore check with Fisher & Paykel's Customer Care Centre to ensure this page correctly describes the model currently available. © Fisher & Paykel Appliances Ltd 2020

Controls

Audio feedback	•
Automatic cooking/minute timer	•
Automatic pre-set temperatures	•
Celsius/Fahrenheit temperature	•
Electronic clock	•
Electronic oven control	•
Soft close doors	•

Power requirements

Amperage	15 A
Supply frequency	50 Hz
Supply voltage	220 - 240 V

Other product downloads available at fisherpaykel.com

- [↓](#) 2D-DWG Oven
- [↓](#) 2D-DXF Oven
- [↓](#) Data Sheet Oven
- [↓](#) Service & Warranty
- [↓](#) Installation Guide Built-In Oven
- [↓](#) Revit Oven
- [↓](#) Rhino Oven
- [↓](#) SketchUp Oven
- [↓](#) User Guide Wall Oven

Product dimensions

Depth	565 mm
Height	598 mm
Width	596 mm

Functions

Bake	•
Classic bake	•
Fan bake	•
Fan forced	•
Fan grill	•
Grill	•
Number of functions	9
Pizza bake	•

Safety

Balanced oven door	•
Catalytic venting system	•
Control panel key lock	•
CoolTouch door	•
Non-tip shelves	•

Where applicable:

All appliances use energy, and energy usage typically generates carbon emissions. **Fisher & Paykel Appliances' In-use Energy Carbon Emissions Estimate** indicates carbon emissions from a product's in-use energy. This is calculated either annually or per cycle, using the product's market-specific energy label energy consumption data multiplied by the carbon emissions factor for energy in your country or region.

Our In-use Energy Carbon Emissions Estimate is designed to assist customers in making informed purchasing decisions when comparing different Fisher & Paykel products. For example, a heat pump dryer typically has a lower In-use Energy Carbon Emissions Estimate than a vented dryer.



A PEACE OF MIND SALE
24 Hours 7 Days a Week Customer Support
T 0800 372 273 W www.fisherpaykel.com