

FISHER & PAYKEL

STEAM OVEN

MINIMAL

OS24SMTDB1

CONTEMPORARY

OS24SDTDX2

USER GUIDE

US CA

CONTENTS

Safety and warnings	5
Before you begin	9
First use	10
Using the oven light	22
Using the kitchen timer	23
Changing the time	25
Locking the control panel	26
Unlocking the control panel	27
Cooking options	28
Delayed cook	29
Auto off	30
Food probe	31
Guided cooking	34
Cooking guide	36
Cooking charts	46
User preference settings	54
Wifi connection and remote mode	56
Sabbath Mode	58
Care and cleaning	60
Descaling the oven	68
Using Steam Clean	70
Troubleshooting	71
Alert codes	74
Warranty and service	75

Registration

To register your product visit our website: fisherpaykel.com/register

IMPORTANT SAFETY INSTRUCTIONS

⚠ WARNING!



Electric Shock Hazard

Failure to follow this advice may result in electric shock or death.

- Turn the oven off at the wall before replacing the oven lamp.

⚠ WARNING!



Fire Hazard

Failure to follow this advice may result in overheating, burning, and injury.

- Do not place aluminium foil, dishes, trays, water or ice on the oven floor during cooking, this will irreversibly damage the enamel. Lining the oven with aluminium foil may cause fire.
- Never use your appliance for warming or heating the room. Persons could be burned or injured or a fire could start.
- Flammable materials should not be stored in an oven or near its surface.

⚠ WARNING!



Cut Hazard

Failure to use caution could result in injury.

- Take care: some edges are sharp.

⚠ WARNING!

Hot Surface Hazard

Failure to follow this advice could result in burns and scalds.



- To avoid burns and scalds, keep children away from this appliance.
- Surfaces of the appliance may become hot enough to cause burns. Examples include the oven vent, the surface near the oven vent, and the oven door.
- Do not touch heating elements or interior surfaces of the oven. Heating elements may be hot, even when they are dark in colour.
- Use protection when handling hot surfaces, such as oven shelves or dishes, or when using steam functions.
- Be careful when opening the oven door as hot air and steam can be emitted, especially when using steam functions. Allow hot air and steam to dissipate before removing or replacing food.
- During and after use, do not touch or let clothing or other flammable materials contact heating elements or interior surfaces of the oven until they have had sufficient time to cool.

SAFETY AND WARNINGS

READ AND SAVE THIS GUIDE

WARNING!

To reduce the risk of fire, electrical shock, injury to persons or damage when using the oven, follow the important safety instructions listed below. Read all the instructions before using the oven. Use the oven only for its intended purpose as described in these instructions.

Installation

- Ensure your appliance is properly installed and earthed by a qualified technician.
- Ensure this oven is connected to a circuit which incorporates an isolating switch providing full disconnection from the power supply.
- Do not install or operate the appliance if it is damaged or not working properly. If you receive a damaged product, contact your dealer or installer immediately.

Servicing

- Do not repair or replace any part of the appliance unless specifically recommended in the user guide. All other servicing should be undertaken by a Fisher & Paykel trained and supported service technician or qualified person.

Fire Hazard

- Do not use water on grease fires. Smother the fire or flame or use a dry chemical or foam type extinguisher.
- Use only dry oven mitts or potholders. Moist or damp potholders on hot surfaces could result in burns from steam. Do not let potholders touch hot areas or heating elements. Do not use a towel or a bulky cloth for a potholder. It could catch fire.
- Do not heat unopened food containers. They can build up pressure that may cause the container to burst and result in injury.

Food Safety

- Leave food in the oven for as short a time as possible before and after cooking. This is to avoid contamination by organisms which may cause food poisoning. Take particular care during warm weather.

General Use

- This product has been designed for use in a domestic (residential) environment. This product is not designed for any commercial use. Any commercial use by the customer will affect this product's manufacturer's warranty.
- Household appliances are not intended to be played with by children.
- Children should not be left alone or unattended in the area where the appliance is in use. They should never be allowed to sit or stand on any part of the appliance.
- Children of less than 8 years old must be kept away from the appliance unless continuously supervised.
- Cleaning and user maintenance shall not be carried out by children without supervision.
- Do not store things children might want above the oven. Children could be burned or injured while climbing on the oven to retrieve items.
- Do not place heavy objects on the oven door.

SAFETY AND WARNINGS

- Always keep oven vents unobstructed. Do not wear loose fitting or hanging garments when using the appliance. They could ignite or melt if they touch an element or hot surface and you could be burned.
- Do not change or modify the wireless communication device in any way. Changes or modifications not expressly approved by Fisher & Paykel could void the user's authority to operate the equipment.
- This device complies with Industry Canada's licence-exempt RSSs. Operation is subject to the following two conditions:
 - ① This device may not cause interference; and
 - ② This device must accept any interference, including interference that may cause undesired operation of the device.
- This device complies with part 15 of the FCC Rules. Operation is subject to the following two conditions:
 - ① This device may not cause harmful interference, and
 - ② this device must accept any interference received, including interference that may cause undesired operation.
- Caution: Hot air can blow from the vent at the top of the oven as part of the oven's cooling system.
- Always position shelves in the desired location while the oven is cool (before preheating). If a shelf must be removed while the oven is hot, do not let the oven mitts or potholder contact hot heating elements in the oven or the base of the oven.
- Use only bakeware approved for oven. Follow the bakeware manufacturer's guidance.
- Always place oven racks in desired location while oven is cool. If rack must be moved while oven is hot, do not let potholder contact hot heating element.
- Do not touch heating elements or interior surfaces of your oven. Heating elements and interior surfaces may be hot even though they are dark in color and could cause burns. The oven door, vent openings and surfaces near these openings may also become hot.
- This appliance is configurable to allow remote operation at any time. Do not store flammable materials or temperature sensitive items inside, on top or near the appliance.
- Neither the food probe or aluminium foil must come in contact with the oven elements.
- Only use the temperature probe recommended for this oven.
- The appliance must not be installed behind a decorative door in order to avoid overheating.
- **WARNING:** Accessible parts may become hot during use. Young children should be kept away.

Cleaning

- Do not clean the oven seal or use any oven-cleaning products on it. It is essential for a good seal, which ensures that the oven operates efficiently. Care should be taken not to rub, damage, move or remove the oven seal.
- Do not use oven cleaners, harsh/abrasive cleaning agents, waxes, or polishes. No commercial oven cleaner, oven liner, or protective coating of any kind should be used in or around any part of the oven.
- Do not use harsh/abrasive cleaners, scourers or sharp metal scrapers to clean the oven door glass since they scratch the surface, which may result in the glass shattering.
- Clean only the parts listed in this manual.
- Do not use a steam cleaner to clean any part of the oven.
- The door gasket is essential for a good seal. Care should be taken not to rub, damage or move the gasket.

BEFORE YOU BEGIN

- Make sure the installer has completed the 'Final checklist' in the Installation guide.
- Read this guide, taking special note of the 'Safety and warnings' section.
- Remove all internal and external packaging and dispose of it responsibly. Recycle items that you can.
- Refit the shelves to your desired position in the oven.
- Condition the oven, using the instructions under 'First use'.

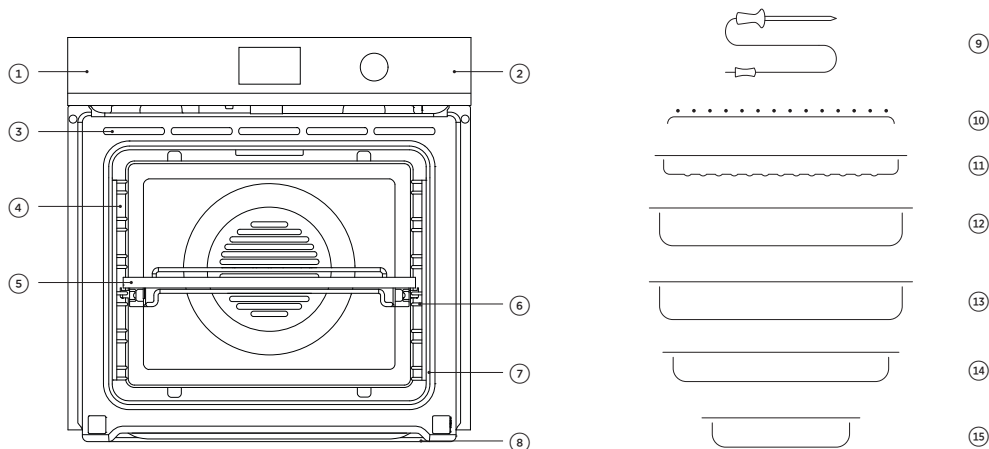

Oven features and accessories

- | | |
|-------------------------------------|-------------------------|
| ① Control panel | ⑨ Food probe |
| ② Water tank compartment | ⑩ Broil rack |
| ③ Oven vent louvres | ⑪ Grid |
| ④ Oven light location | ⑫ Broil pan |
| ⑤ Full extension sliding shelf (x2) | ⑬ Large solid pan* |
| ⑥ Side rack | ⑭ Large perforated pan* |
| ⑦ Oven seal | ⑮ Small perforated pan* |
| ⑧ Drip channel | |

Not shown: oven door and handle, wire shelf and water tank.

Not all accessories are provided with all models. To purchase other accessories, contact your nearest Fisher & Paykel Service Centre, Customer Care or visit www.fisherpaykel.com

*Not intended for use over 210°F (100°C)

FIRST USE

Control panel

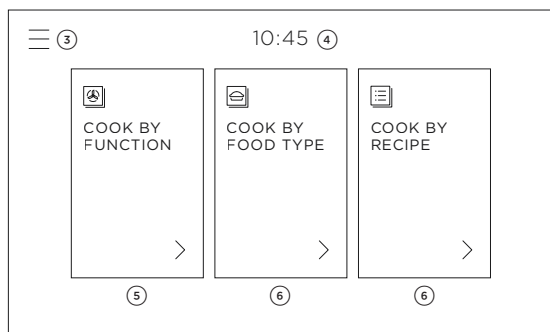
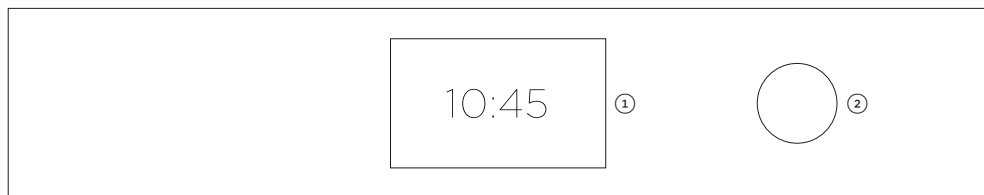

Control panel features

- 1 Touch screen display
- 2 Control dial*
- 3 Menu
- 4 Clock
- 5 Oven functions
- 6 Guided cooking features

Touch screen display

Your oven is operated using an intuitive touch screen display. Use the screen to navigate cooking functions, guided cooking features and settings.

Using the touch controls

Use the ball of your finger, not its tip. The controls respond to touch, so pressure is not needed.

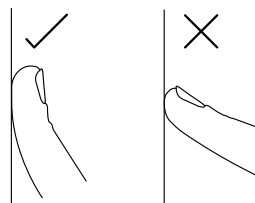

Control dial

- Turn the control dial to scroll through menu items and set timers.
- Press to select or confirm.
- Press and hold to go back.

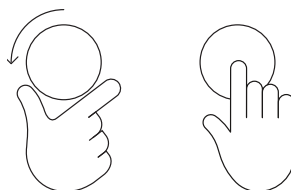

FIRST USE

Setting the clock and mains supply voltage

You'll need to set the time on your oven when it is first turned on, or after a power cut. You'll also need to select the mains supply voltage for your home.

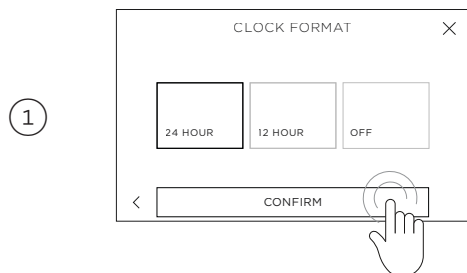

Set the clock format. Choose between **24 HOUR**, **12 HOUR** or **OFF** then select **CONFIRM**.

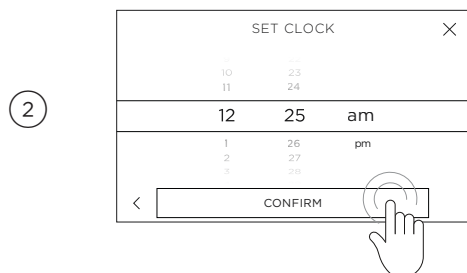

Scroll to set the correct time then select **CONFIRM**.

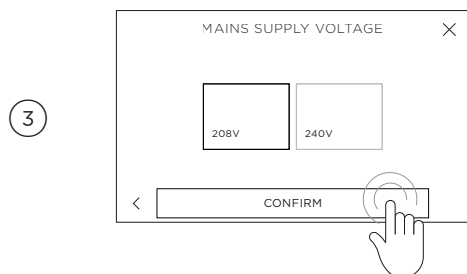

Select the mains supply voltage for your home. Choose between **208V** and **240V** then select **CONFIRM**.

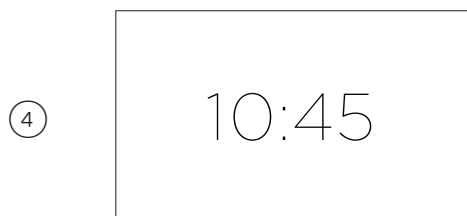

The mains supply voltage and time are now set. The time will show on the screen.

FIRST USE

Oven racks

Your oven comes with the shelves positioned and secured inside. The following shows you how to remove and reposition them to your preferred position.

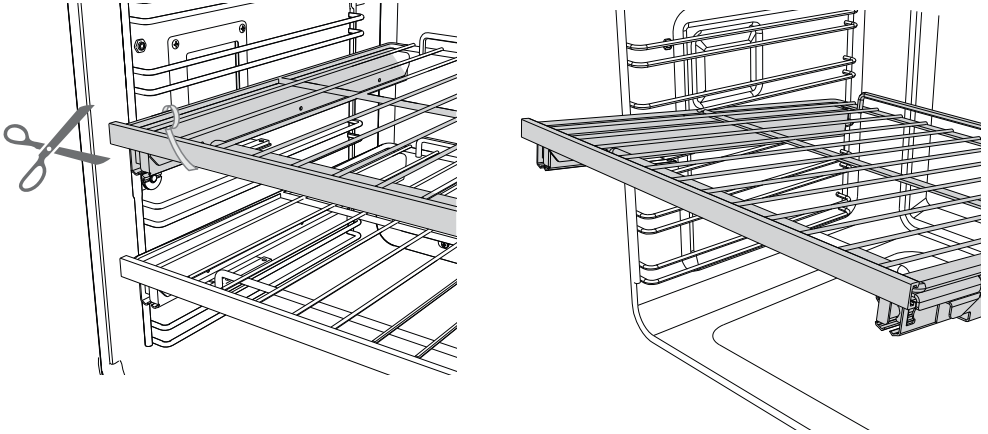

Remove shelves from the oven

- ① Remove all cable ties and packaging holding the shelves in place.
- ② Remove all the shelves, taking special care with the sliding shelves.
- ③ To remove a sliding shelf, grip it at the front (making sure you are gripping the wire shelf and the sliding frame together), lift upwards and pull it out of the oven.

For your safety, the wire shelves and sliding frames are built together as one unit and are not separable. When placed properly on the side racks, the slides will prevent the wire shelves from tilting when pulled towards you.

FIRST USE

Replace shelving in your preferred positions

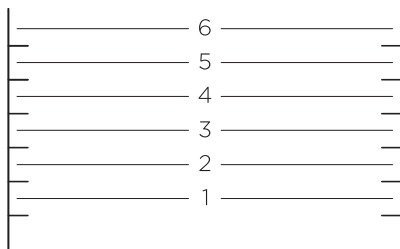

Shelf positions

We recommend placing the sliding shelves on positions 2 and 4 for everyday cooking.

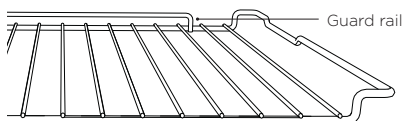

To replace wire shelves

Check the shelf is positioned correctly, with the guard rail at the back, then slide into place on the side racks.

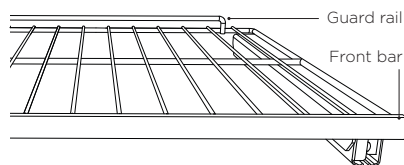

To replace sliding shelves

- ① Grip the shelf at the front (making sure you are holding the wire shelf and the sliding frame together).
- ② Make sure the shelf is level and facing the right way with the guard rail at the back.
- ③ Place the shelf on top of the side racks at the desired height, hooking the rear tags over the side racks on both sides.
- ④ Push the shelf all the way into the oven, making sure the front tags are also securely hooked over the side racks.

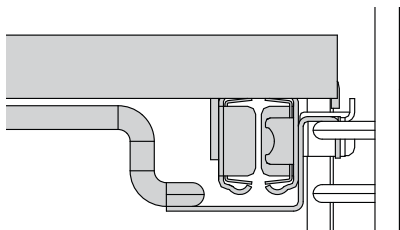

Ensure sliding shelves are positioned on top of the side rack wires instead of between them.

When there is food in the oven, take care to slide the shelves horizontally when extending them. This will prevent the tags lifting off the side racks and the shelf tipping over.

FIRST USE

Water tank compartment

Some parts of the water tank compartment have protective packaging. The following shows you how to access the water tank compartment and remove the protective wrap.

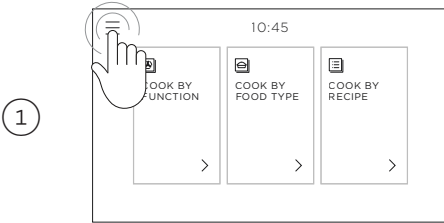

Touch the menu icon in the top left corner of the screen.

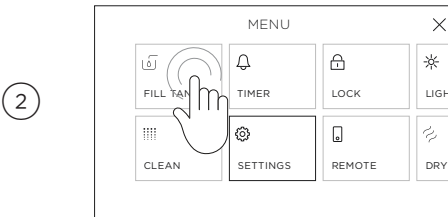

Select **FILL TANK**.

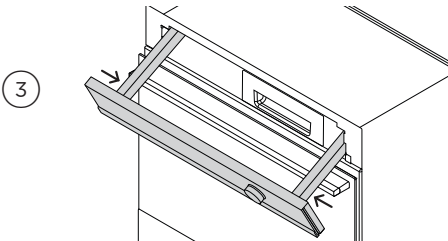

Remove protective wrap from the control panel arms.

Press the screen to close control panel.

FIRST USE

Conditioning the oven

It is important to condition your oven before using it for cooking. This will burn off any manufacturing residues and ensure that you get the best results right from the start. It will take approximately 1 hour.

Before you start:

Ensure you have removed all packaging and any cable ties used to secure the shelving during transit. Ensure all shelves are fitted in the oven. Ensure the kitchen is well ventilated during conditioning.

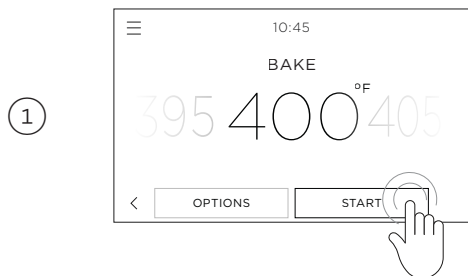

Set the function to **BAKE** at 400°F (200°C) and heat for 30 minutes.



After 30 minutes change the function to **AERO BROIL** and heat for 5 minutes.



After 5 minutes, change the function to **TRUE AERO** and heat for a further 20 minutes.

When you have finished, turn the oven off.

After conditioning:

There will be a distinctive smell and a small amount of smoke during the conditioning process as manufacturing residue is burnt off. This is normal, but make sure the kitchen is well ventilated. Once cooled, wipe out the oven with a damp cloth and mild detergent, and dry thoroughly.

FIRST USE

Setting the water hardness level

Before using any steam functions for the first time, the water hardness level should be set. If you are unsure on your water hardness level, contact your local water supplier.

We do not recommend using this product with water hardness above 450ppm.

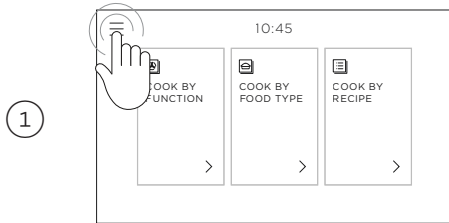

Touch the menu icon in the top left corner of the screen.

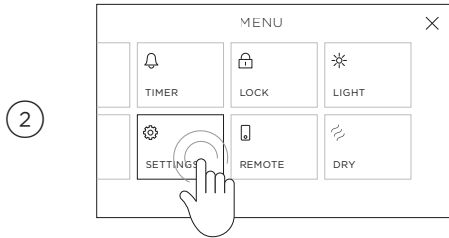

Enter the settings menu.

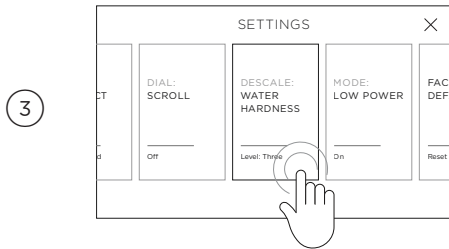

Select **DESCALE: WATER HARDNESS**.

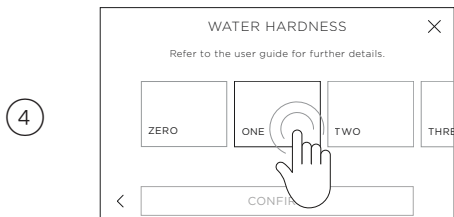

Select your water hardness level:

WATER HARDNESS (PPM)	LEVEL
0 - 100	ZERO
100 - 250	ONE
250 - 350	TWO
350 - 450	THREE

FIRST USE

Filling the water tank

Before using any steam functions, you'll need to fill the water tank. For best results, we recommend filling the tank with fresh water before you cook.



Select the desired steam function and temperature, and press **START**.

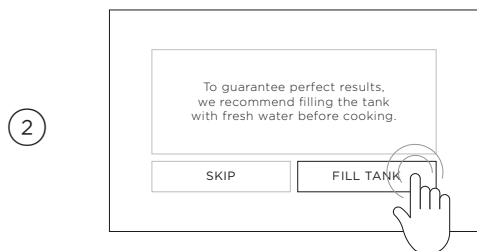

Select **FILL TANK**.

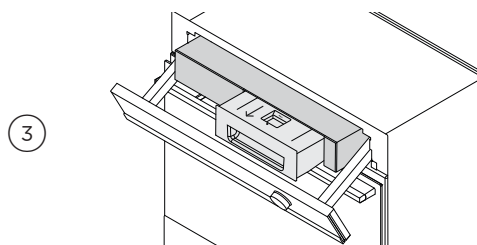

When prompted, press the touch screen to open the control panel. Pull water tank out and fill to the **MAX** fill line.

Push the tank back in and press the screen to close control panel.

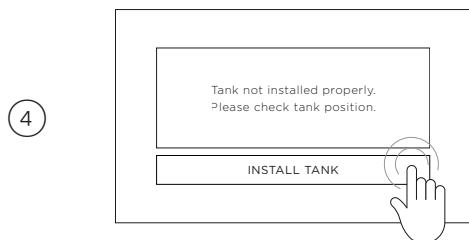

If the tank is incorrectly re-installed or the water level is too low, follow the onscreen guidance before continuing.

FIRST USE

Selecting a function

To select and use a function, enter the function category menu before touching the function name or icon to select. Functions may vary depending on your oven model.

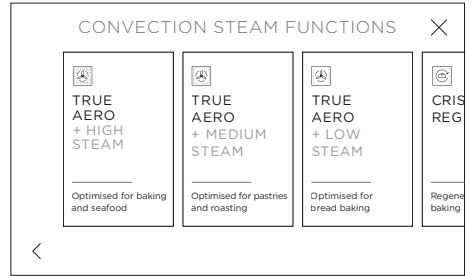
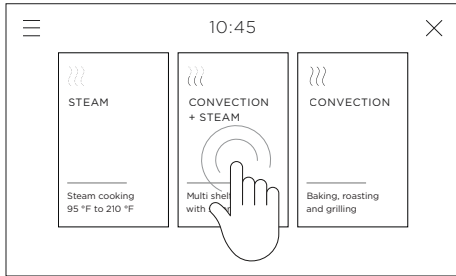

Expanding a description

For more information on each function or category, touch the description underneath each function or category name.

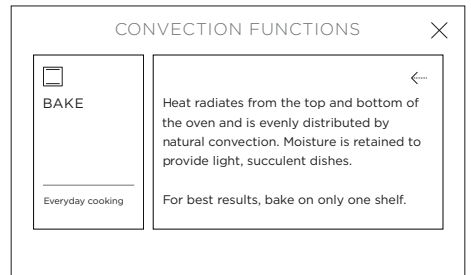
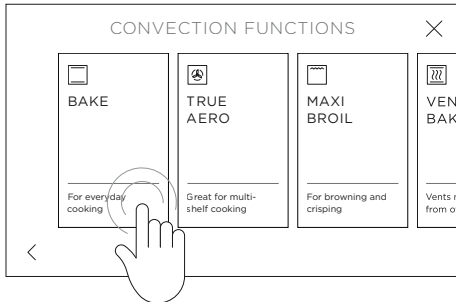

FIRST USE

Setting a function and temperature

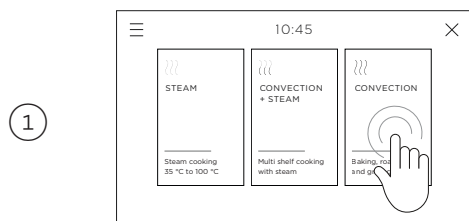

Touch the screen or turn the dial* to enter the menu. Select **COOK BY FUNCTION**, followed by the desired function category menu.

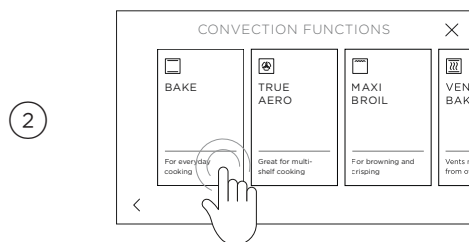

Scroll through the functions and select the desired option.



To adjust the preset temperature, swipe left or right or use the dial. Touch **START** to heat the oven and begin cooking.

A red bar will show on the screen while the oven is heating.

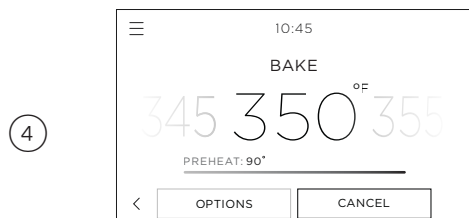

When the oven has reached the set temperature, a tone will sound, the bar will disappear and the dial* will turn red.

Some functions do not need to preheat. For those functions the bar won't show and the dial halo will remain red throughout cooking.

Rapid preheating stage

For some cooking functions, the oven will go through an initial rapid preheat stage. In this stage, the fan and both bake and broil elements will turn on to quickly heat the oven to the set temperature. Depending on the cooking function, the fan, bake and broil elements will turn off once the oven reaches the set temperature.

*some models only

FIRST USE

Editing or cancelling cooking

Touch the function name or temperature at any point during cooking to adjust.

Changing the temperature



Changing the function

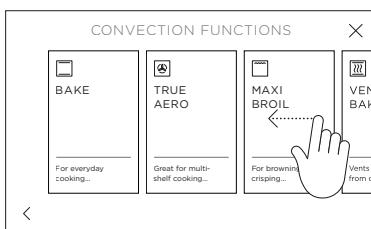

Turning the oven off



To stop cooking and turn the oven off, press **CANCEL** and then **CONFIRM** at any point

FIRST USE

Post steam drying

After running a steam function, there may be some moisture left in the oven. Wait for the oven to cool, then wipe out the base of the cavity with a sponge or soft cloth.

You may also be prompted to run a dry cycle after you have finished cooking.

During this stage, the fan and both bake and grill elements will turn on to quickly heat and dry the oven. After the dry cycle, the drip tray should be removed and emptied if required. It is important to remove any food from the oven before starting drying due to the cavity heating.

You may postpone the dry cycle if further cooking is required, however a dry cycle should be completed at the earliest possible opportunity.

If the dry cycle is repeatedly skipped, there is significant risk of corrosion damage to the product and warranty will be void.

USING THE OVEN LIGHT

Turning the oven light ON or OFF

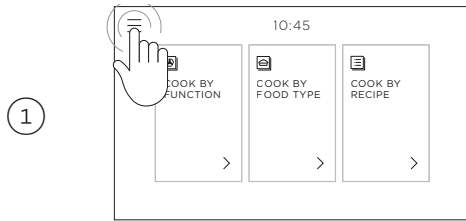

Touch the menu icon in the top left corner of the display.

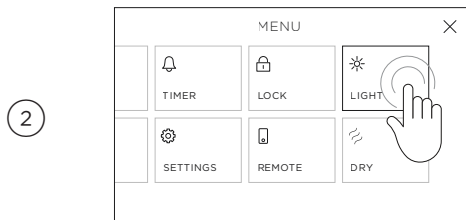

Select **LIGHT**.

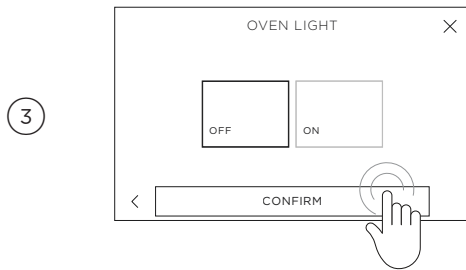

Select **ON** or **OFF** as required and then select **CONFIRM**.

USING THE KITCHEN TIMER

- Use the kitchen timer to keep track of cooking times. You can use it at any time, even if you are not using the oven.
- The kitchen timer does not turn the oven off. See 'Guided cooking' for how to set the **AUTO OFF** timer or **DELAYED COOK**.

Setting the timer

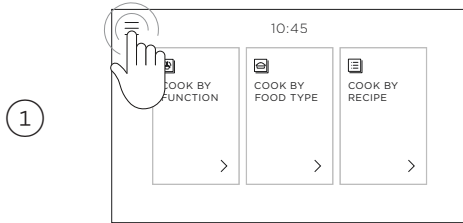

Touch the menu icon in the top left corner of the screen.

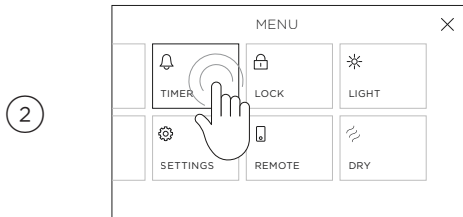

Select **TIMER**.

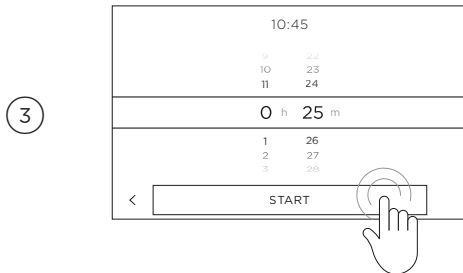

Scroll to set the timer length then select **START**.

You can set the timer up to 11 hours 59 minutes.



The timer countdown will show on the screen.

USING THE KITCHEN TIMER

Editing or cancelling the timer

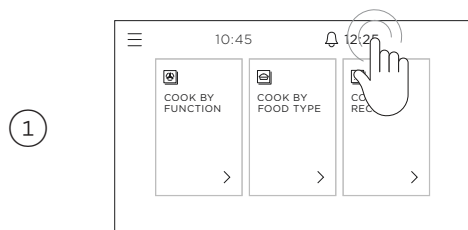

Touch the timer countdown in the upper right of the screen.

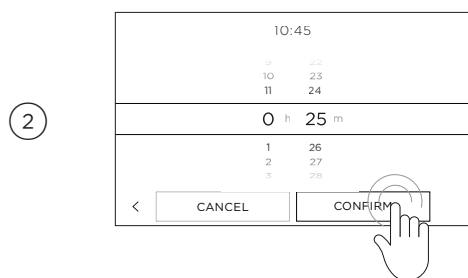

Adjust the timer as needed and select **CONFIRM**, or touch **CANCEL** to cancel the timer completely.

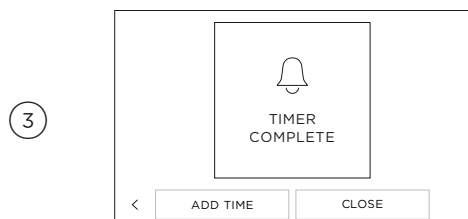

At the end of the timer a tone will sound intermittently.

Select **CLOSE** to return to the home screen, or touch **ADD TIME** to set another timer.

CHANGING THE TIME

1



Touch the menu icon in the top left corner.

2

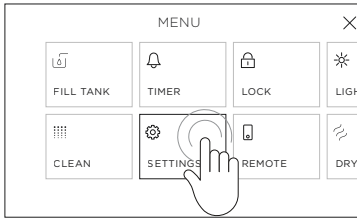

Select **SETTINGS**.

3

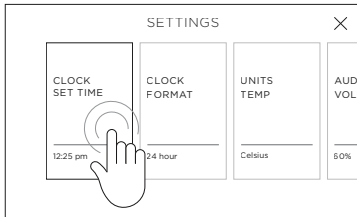

Select **CLOCK SET TIME**.

4

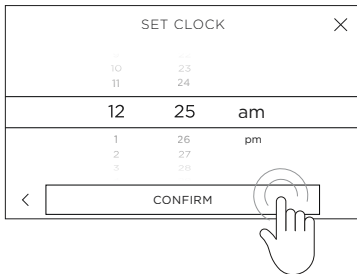

Scroll to change the time then select **CONFIRM**.

LOCKING THE CONTROL PANEL

Lock the oven controls to prevent accidental use of the oven by children or when cleaning. When locked, the controls are unresponsive and the oven will not turn on.

For safety reasons you cannot lock the oven controls while the oven is in use or if automatic cooking options have been set.

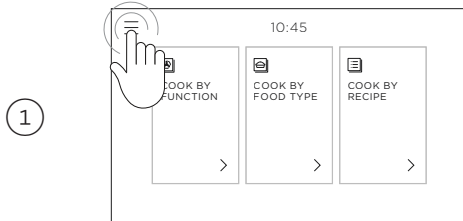

Touch the menu icon in the top left corner of the screen.

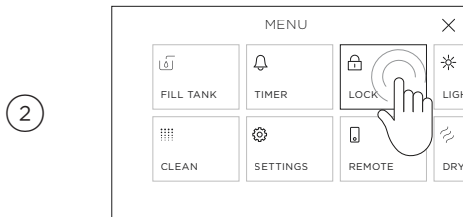

Select **LOCK**.



Select **CONFIRM**.

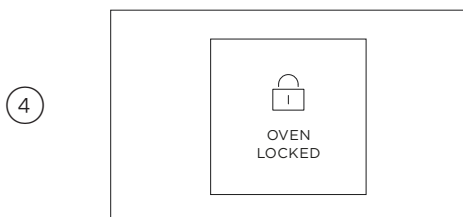

The control panel is now locked. The controls will remain unresponsive until it is unlocked.

UNLOCKING THE CONTROL PANEL

1

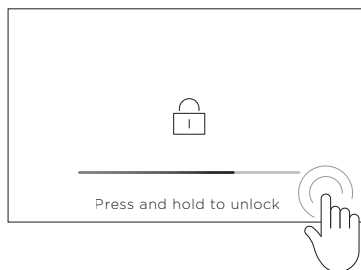

Press anywhere on the screen and hold until the bar fills to unlock the oven.

COOKING OPTIONS

Your oven comes with a number of automatic cooking options to help you get the best results:



DELAYED COOK

Set the oven to turn on later in the day, cook for a set length of time and turn off automatically.



AUTO OFF

Set the oven to turn off after a set length of time.



FOOD PROBE

Use the food probe to automatically turn your oven off when your food reaches a set internal temperature.

You can set these options either before you start cooking, or at any point once your oven is already running.

1

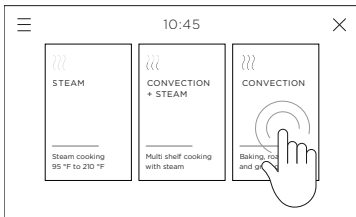

Select **COOK BY FUNCTION** followed by the desired function category.

2

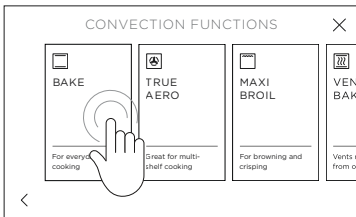

Select the function you want to cook with.

3



Touch **OPTIONS** at the bottom of the screen and select either: **DELAYED COOK**, **AUTO OFF** or **FOOD PROBE**.

DELAYED COOK

The broil element will come on while the oven is heating up. Position food on a lower shelf or cover to prevent burning as the oven heats up.

Safe food handling: leave food in the oven for as short a time as possible before and after cooking or defrosting, to avoid contamination by organisms which may cause food poisoning. Take particular care during warmer weather.

When using **DELAYED COOK** we do not recommend using **MAXI BROIL**, **AERO BROIL STEAM PROOF**, **STEAM DEFROST** or **AIR FRY** functions.

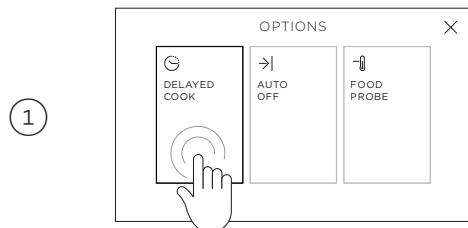

Select **DELAYED COOK** from the **OPTIONS** menu.



Scroll to set a cook duration and an end time, then select **START**.

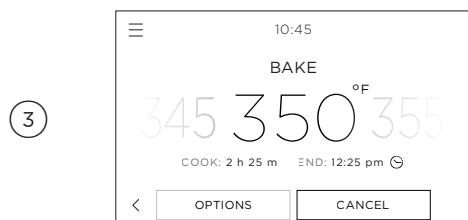

DELAYED COOK is now set.

Your oven will automatically calculate when it needs to turn on based on what cook duration and end times are set.



To edit or cancel

Touch **OPTIONS** and select **DELAYED COOK** at any point to edit or cancel.

When the end time is reached

The oven will automatically turn off and a tone will sound.

AUTO OFF

1

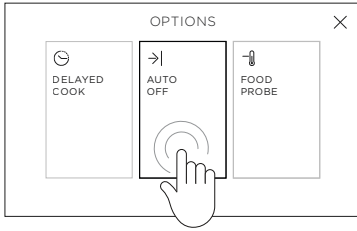

Select **AUTO OFF** from the **OPTIONS** menu.

2

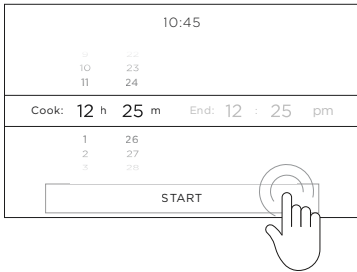

Scroll to set a cook duration and select **START**.

Your oven will automatically calculate the end time based on what cook duration is set.

3



AUTO OFF is now set.

Your oven will cook for the set length of time and then turn off automatically.

4



To edit or cancel

Touch **OPTIONS** and select **AUTO OFF** at any point to edit or cancel.

When the end time is reached

The oven will automatically turn off and a tone will sound.

FOOD PROBE

Tips for using the food probe

- You can still use the kitchen timer when the probe is in use.
- You cannot use the food probe with **DELAYED COOK** or **AUTO OFF**.
- The internal temperature of meat will continue to rise by a few degrees after you have removed it from the oven, so allow for this in your calculations. After cooking, cover and let the meat rest for 15 to 20 minutes.
- If you wish to remove food from the oven (eg basting), unplug the food probe from the oven but do not remove it from the meat. When you are ready to resume cooking, ensure you plug the probe plug back into the oven.
- When cooking meat, insert the probe horizontally into the centre of the thickest part. The thicker the meat, the longer it will take to cook, so it is important that the tip of the probe is measuring the temperature of the meat at its thickest point. Make sure the tip of the probe is not protruding out of the meat, and does not touch bone, fat or gristle, as these will heat up more quickly than the lean meat.

Internal temperatures and food safety

- Ensure meat is fully defrosted before cooking. The temperatures given onscreen and in the Cooking Guides are recommendations. Results will depend on the quality and composition of the food.
- Rest meat after cooking to allow the internal temperature to continue to rise.
- For food safety, high risk foods such as fish should reach a minimum internal temperature of 145°F (63°C) and poultry and minced meat should reach 170°F (75°C).

FOOD PROBE

Setting FOOD PROBE

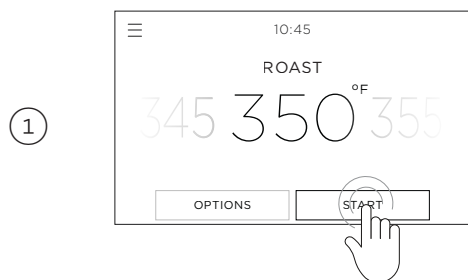

Select your function and temperature and preheat the oven if needed.

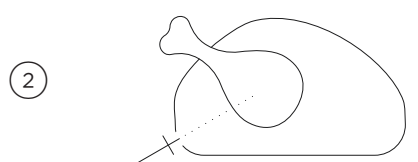

Insert the probe into your food.

Always position the tip of the probe in the thickest part of the dish, avoiding fat and bone in meat.

Ensure the tip of the probe doesn't protrude out the other side of food or touch cookware.

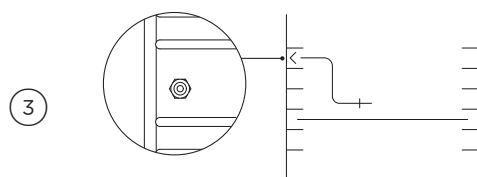

Place food in the oven and plug the probe into the socket inside the oven, on the left hand side.

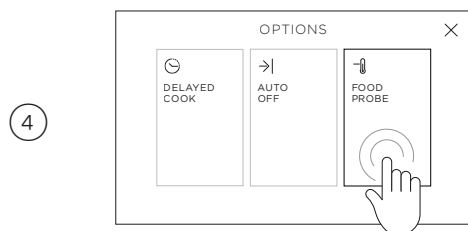

Go to the **OPTIONS** menu and select **FOOD PROBE**.

FOOD PROBE

5



Scroll to select a food type and adjust the temperature if desired. Select **START** to begin.

6

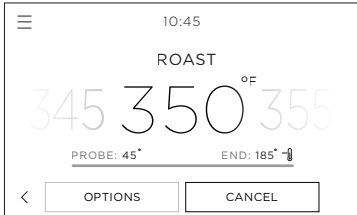

FOOD PROBE is now set.

Your oven will cook until the set temperature is reached and then turn off automatically.

7

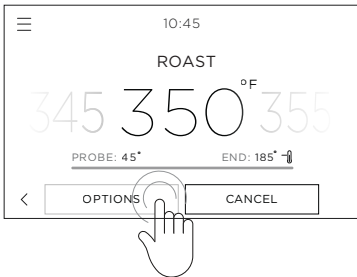

To edit or cancel

Touch **OPTIONS** and select **FOOD PROBE** at any point to edit or cancel.

When the end time is reached

The oven will automatically turn off and a tone will sound.

GUIDED COOKING

Your oven comes with guided cooking features that help you choose the optimal oven settings, accessories and methods to get the best results:



COOK BY FOOD TYPE

Optimum oven settings, shelf positions, cookware and accessories for cooking a particular type of food or cut of meat.



COOK BY RECIPE

A collection of recipes that have been specifically designed for and tested in this style of oven.

Using COOK BY FOOD TYPE

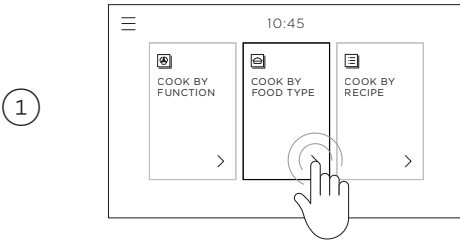

From the home screen, select **COOK BY FOOD TYPE**.

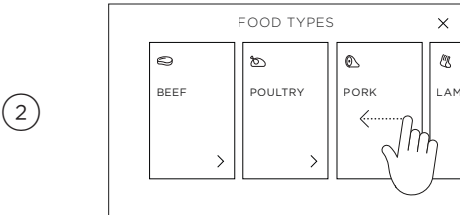

Scroll through the various food types and select the type of food you want to cook.

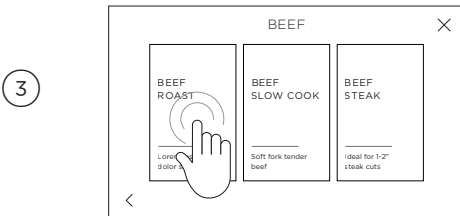

Select the cooking option you want to use.

For more information, touch the description underneath each option to expand.



Follow the instructions onscreen for what accessories and cookware to use and how to set up your oven.

GUIDED COOKING

Using COOK BY RECIPE

1

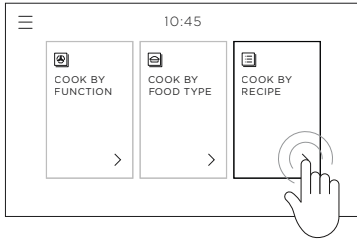

Select **COOK BY RECIPE**.

2

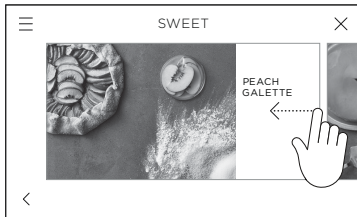

Scroll to look through the recipe collection and select your favourite. Follow the instructions onscreen for ingredients and method, and oven set up.

COOKING GUIDE

General guidelines

This oven has been designed to utilise its four elements and rear fan in different combinations to provide you with enhanced performance. The wide range of functions allow you to cook all food types to perfection.

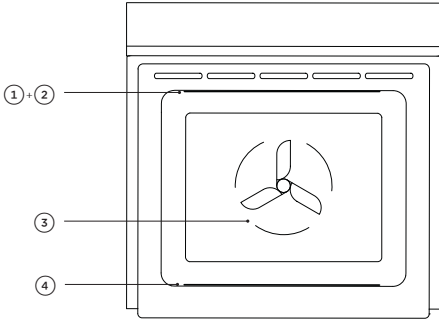

Oven elements

- ① upper outer element
- ② upper inner element
- ③ rear element (concealed)
- ④ lower element (concealed)

Ensure the oven door is closed when cooking.

Baking

- For best results when baking, always pre-heat your oven. The screen will show a red progress bar while the oven is heating up.
- **Single shelf cooking:** place your baking on a shelf that will position the top of your pan near the centre of the oven.
- **Multi shelf cooking:** Always leave a space between shelves to allow the air to circulate.

Broiling

- Always broil with the oven door completely shut.
- Always keep a close watch on your food to avoid charring or burning.
- If you use glass or ceramic pans, be sure they can withstand high oven temperatures.
- For thinner cuts of meat, or for toasting or browning foods, use a higher shelf position.
- Thicker cuts of meats should be broiled on lower shelves or at a lower broil setting to ensure even cooking.

Roasting

- The **ROAST** function is designed to brown the outside of the meat, but still keep the inside moist and juicy.
- Boneless, rolled or stuffed roasts require longer than roasts containing bones. Poultry should be well cooked with the juices running clear and a minimum internal temperature of 165°F (75°C).
- Always roast meat fat side up.
- If using a roasting bag or a covered roast dish, do not use the **ROAST** function.

COOKING GUIDE

Reheating

- Never reheat food more than once.
- Use **STEAM REGENERATE** or **CRISP REGENERATE** to reheat food, or follow the instructions in **COOK BY FOOD TYPE**.
- Always reheat food to piping hot, or to a minimum internal temperature of 185°F (85°C). This reduces the risk of contamination.
- Reheat food in a dish with a lid or cover tightly with foil.
- Once hot, use the **WARM** function to keep the food warm.

Proofing

- Use the **STEAM PROOF** functions to proof dough for breadmaking and pizza.
- Place dough in a lightly oiled bowl and cover with plastic wrap, a clean damp cloth or uncovered if using Steam Proof.
- Position in the centre of the oven.
- To prevent overproofing check the dough every 30 minutes.

Steaming

- When using perforated pans, always place the solid pan at a shelf position lower to collect cooking juices.
- Slice or chop vegetables into equal sized shapes for even cooking.
- After each steam use, it is recommended to empty drip tray before next use to prevent overfilling.
- For best results, ensure food is laid out evenly across pans for even cooking.
- Use steam to retain nutrients & texture of a wide range of food.

Maximum steam cooking times

The maximum cooking times apply when using steam functions.

We recommend staying within these cooking times to avoid a build up of condensation inside the oven.

If large volumes of water are allowed to build up inside the oven, this may leak outside the appliance.

TEMP (°F)	TEMP (°C)	MAX COOKING TIME (MIN)
210	100	120
195	90	120
175	80	120
160	70	280
140	60	320
120	50	360

COOKING GUIDE

Steam functions

Steam cooking will increase the quantity of steam emitted from the product when the door is opened. Use caution when opening the door and allow any excess hot air and steam to dissipate before removing or replacing food.

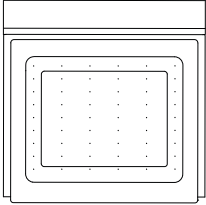

STEAM

Steam is generated from the rear of the oven and distributed evenly throughout by the fan

Ideal for:

maximising nutrients and flavour.

- Steam retains foods nutrients, colour and texture. Use steam within the whole temperature range to cook a wide variety of foods, maximising quality & flavour.
- Alternative uses include heating towels & sanitising jars.
- Steamed vegetables are best cooked in fully preheated oven.

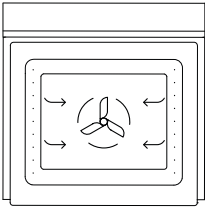

SOUS VIDE

Precise and evenly controlled temperature using steam

Ideal for:

proteins: eggs, meat, poultry, seafood, as well as a wide range of fruit & vegetables.

- Allows temperatures to be adjusted by 2°F (1°C) increments, guaranteeing even cooking. Can be used with or without vacuum sealing food.
- Preheating oven is not required, however oven should be around room temperature before using **SOUS VIDE**.

COOKING GUIDE

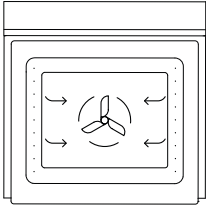

STEAM REGENERATE:

Steam is generated from the rear of the oven and distributed evenly throughout by the fan

Ideal for:

reheating precooked foods.

- Ensure cooked meals, roast meats, risottos are reheated to perfection without drying.
- Preheating oven is not required.

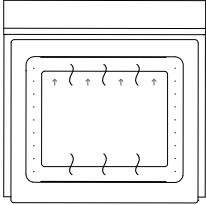

STEAM PROOF

Prevents dough from drying

Ideal for:

any dough based recipe.

- Steam prevents dough from drying out by providing an ideal environment for the activation of yeast.
- Preheating oven is not required, however oven should be around room temperature before using **STEAM PROOF**.

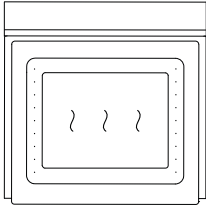

STEAM DEFROST

Defrosts without drying

Ideal for:

frozen vegetables, meat, and fruit, as well as frozen meals.

- Steam helps retain colour and moisture.
- Preheating oven is not required.

COOKING GUIDE

Convection + Steam functions

For best results, preheat oven fully before cooking

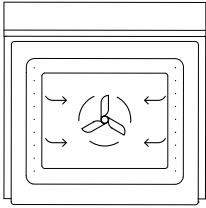

TRUE AERO + LOW STEAM

Fan circulates air from rear element with low intensity steam introduced at regular intervals

Ideal for:

promoting thin crust and colour baked dishes.

- Low moisture adds benefit for browning baked dishes such as lasagne. Promotes a thin crust and even colour when baking bread and provides a soft internal texture and crisp exterior when roasting vegetables.

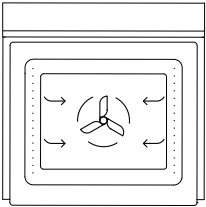

TRUE AERO + MEDIUM STEAM

Fan circulates air from rear element with medium intensity steam introduced at regular intervals

Ideal for:

promoting browning and soft textures.

- Medium level of moisture promotes even browning of scones and gratins while enhancing a soft, even texture to baked cheesecakes.

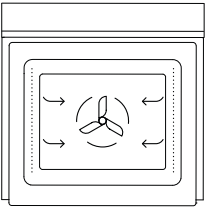

TRUE AERO + HIGH STEAM

Fan circulates air from rear element with high intensity steam introduced at regular intervals

Ideal for:

providing moisture for delicate cooking.

- High moisture provides an ideal environment for delicate seafood while ensuring dense fruit cakes brown without drying out.

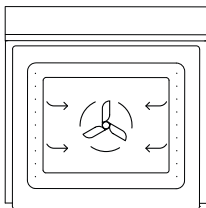

CRISP REGENERATE

Fan circulates air from rear element with optimized steam

Ideal for:

pastries and breads.

- Heat and steam create perfect conditions to regenerate pastries, breads, pizza & pies as if they were just freshly baked.

COOKING GUIDE

Convection functions

For best results, preheat oven fully before cooking

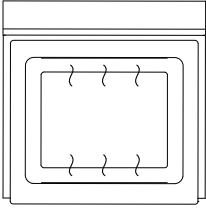

BAKE

Distributes heat evenly by natural convection

Ideal for:

cakes and foods that require baking for a long time or at low temperatures.

This function will preheat for around 8 minutes to 355°F (180°C).

- Retains moisture.
- Ideal for cakes and foods that require baking for a long time or at low temperatures.
- This function is not suitable for multi-shelf cooking.

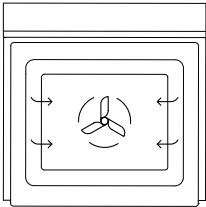

TRUE AERO

Distributes heat evenly by fan

Ideal for:

multi-shelf cooking, eg biscuits, cookies, scones, muffins and cupcakes.

- Hot air is blown into the cavity, providing a consistent temperature at all levels.
- Always leave a gap between trays to allow air to move freely. This ensures food on the lower tray can still brown.
- If converting a recipe from **BAKE** to **TRUE AERO**, we recommend that you decrease either the bake time and/or the temperature by approximately 70°F (20°C), especially for items with longer bake times.

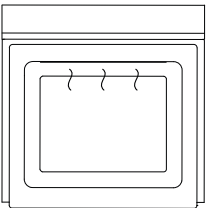

MAXI BROIL

Generates intense heat from the top elements only

Ideal for:

toasting bread or for top-browning to finish off dishes.

This function will preheat for around 8 minutes to 355°F (180°C).

- Intense radiant heat is delivered from both top elements.
- There are 9 steps between **LO** and **HI** (100% power).
- For best results allow oven to heat for 5 minutes before broiling.
- The dial halo* will remain red while using the **MAXI BROIL** function.

*some models only

COOKING GUIDE

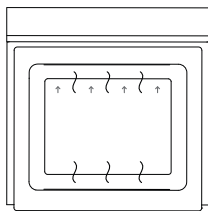

VENT BAKE

Distributes heat from upper and lower elements plus venting

Ideal for:

single shelf baking such as meringues, yorkshire pudding, and finishing off choux pastry, croissants and bread.

This function will preheat for around 8 minutes to 355°F (180°C).

- Vents removes excess moisture from the oven, promoting the gradual development of delicious, savoury flavours.
- Gently cooks to give a succulent and tender result.

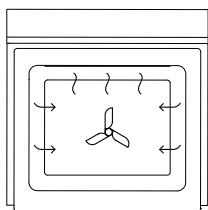

AERO BROIL

Fan circulates intense heat from top elements

Ideal for:

whole chicken, beef tenderloin or broiling fish or steak.

- Uses the intense heat from the elements for top-browning and the fan to ensure even cooking of foods.
- Meat, poultry and vegetables cook beautifully; food is crisp and brown on the outside while the inside remains moist and tender.

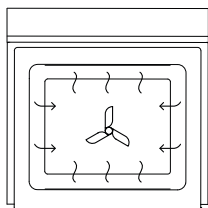

AERO BAKE

Oven fan circulates air from top and bottom

Ideal for:

single shelf baking that requires less than an hour to cook. Foods such as muffins, biscuits and cupcakes.

- The oven fan circulates hot air from the top outer and the lower elements and distributes it around the oven cavity.
- Food cooked tends to brown quickly.

COOKING GUIDE

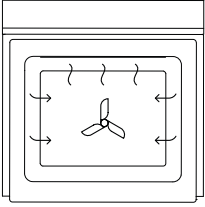

ROAST

Optimized for roasting

Ideal for:

roasting meat and vegetables.

This is a two-step program.

Searing:

An initial 20-minute stage that crisps and browns the roast, and caramelises the outside of the meat.

Cooking at preset temperature:

After searing, the temperature will decrease to your preset level for the remainder of the cook time, producing a tender and juicy roast.

- The oven does not need preheating.
- If desired, use the broil pan and grid, or place vegetables under the roast to allow the juices to drain away from your meat. This will allow the hot air to circulate under the meat as well.

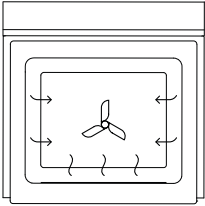

PIZZA BAKE

Oven fan circulates heat from lower element

Ideal for:

crisp-based pizzas.

This function will preheat for around 8 minutes to 355°F (180°C).

- The fan circulates heat from the lower element throughout the entire oven.
- Excellent for cooking pizza as it crisps the base beautifully without overcooking the topping.
- For best results, pre-heat a pizza stone for at least 1 hour and bake on oven shelf position 1 or 2.

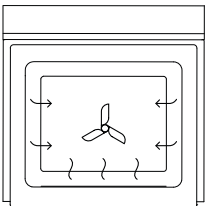

PASTRY BAKE

Oven fan circulates heat from lower element

Ideal for:

sweet and savoury pastry foods and delicate foods that require a crisp base and some top-browning, eg frittata, quiche.

This function will preheat for around 8 minutes to 355°F (180°C).

- The fan circulates heat from the lower element throughout the oven.
- Provides intense heat to the base of foods and allows gentle top-browning.

COOKING GUIDE

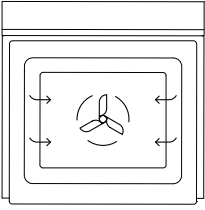

SLOW COOK

Fan circulates heat from rear element

Ideal for:

slow-cooked dishes such as casseroles, stews and braises.

- The fan circulates heat from the rear element to gently cook food.
- This function has low energy consumption — oven lights will remain off and vents will remain closed for the duration of cooking to conserve energy (you may observe some moisture generation during this time).
- The oven does not need preheating.

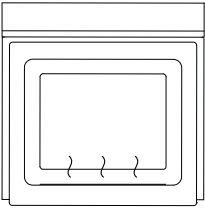

CLASSIC BAKE

Provides heat from lower element

Ideal for:

dishes that require delicate baking and have a pastry base, such as custard tarts, pies, quiches and cheesecake.

This function will preheat for around 8 minutes to 355°F (180°C).

- Heat comes from the lower element only.
- This is the traditional baking function, suitable for recipes that were developed in conventional ovens.
- Bake using only one shelf at a time.

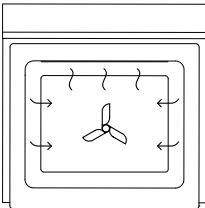

AIR FRY

Fan circulates heat from upper outer and inner elements

Ideal for:

food cooked from frozen, or battered and crumbed food that would usually be deep fried.

- Replicates the conditions used in an air fryer.
- A healthier way of frying which crisps food while using less oil. For best results, coat food with 1-2 tablespoons of oil.
- For pre-packaged food: if the manufacturer's cooking advice suggests using a function that isn't fan-based, decrease temperature by 70°F (20°C).
- **Single shelf cooking:** cook in the upper part of the oven, but not at the highest shelf position.

COOKING GUIDE

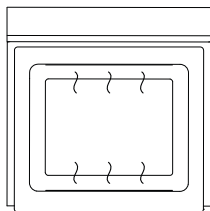

WARM

Upper outer and lower elements plus venting

Ideal for:

keeping cooked food hot, or to warm plates and serving dishes.

- Provides a constant low heat to keep food hot.
- To reheat food from cold, use another function or **COOK BY FOOD TYPE** to heat the food piping hot, then change to **WARM**, as this function alone will not bring cold food up to a high enough temperature to kill any harmful bacteria.

COOKING CHARTS

Shelf positions

- Position shelves before you turn the oven on.
- Shelf positions are counted from the base up, with 1 being the lowest shelf position and 6 the highest.

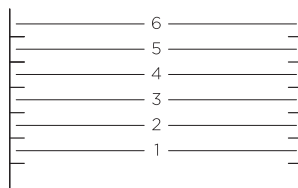

During cooking

- Preheat the oven to the required temperature.
- The broil element may come on while the oven is heating up.
- The screen will show a red temperature bar while the oven is heating up.
- Oven accessories may temporarily deform slightly when they become hot. This is normal and does not affect their function.

BAKING	SHELVES	FUNCTION	SHELF POSITION	TEMP (°F)	TEMP (°C)	TIME (MIN)
BISCUITS						
Plain	Single	Aero Bake	2	410-430	210-220	8-10
	Multi	True Aero	2 and 4	420-445	215-230	10-12
Chewy chocolate chip	Single	Aero Bake	3	355-375	180-190	10-15
	Multi	True Aero	3 and 5	320-340	160-170	10-15
Sugar cookies	Single	Aero Bake	3	350-375	175-190	7-15
	Multi	True Aero	3 and 5	320-350	160-175	7-15
CAKES						
Pound cake	Single	Bake	2	350	175	20-25
Butter/chocolate	Single	Bake	3	320-360	160-180	50-60
Angel food cake	Single	Bake	2	320-350	160-175	50-60
Rich fruit	Single	Bake or True Aero + High Steam	2	275-300	135-150	3-6 hrs
Sponge (single large)	Single	Bake	2	350	175	30-40
Sponge (2 small pans)	Single	Bake	2	340-375	170-190	15-25
Brownie	Single	Bake or True Aero + Medium Steam	2	320-360	160-180	30-40
BANANA BREAD/CAKE	Single	Fan Forced + Low Steam	2	320-375	160-190	60-70
ENGLISH SCONES	Single	Bake or True Aero + Medium Steam	3	400-445	200-230	10-12

COOKING CHARTS

BAKING	SHELVES	FUNCTION	SHELF POSITION	TEMP (°F)	TEMP (°C)	TIME (MIN)
MUFFINS/CUPCAKES	Single	Aero Bake	3	365	185	13-18
	Multi	True Aero	2 and 4	340	170	13-18
MERINGUES	Single	Vent Bake	2	210-250	100-120	60
BREAD						
Rolls	Single	True Aero + Low Steam	2	320-375	160-190	15-25
Loaf	Single	True Aero + Low Steam	2	375-410	190-210	30-40
Reheat soft rolls	Single	Crisp Regenerate	3	320	160	5-10
Reheat crusty bread	Single	Crisp Regenerate	3	400	200	5-10
PASTRY						
Pastry shell (blind baked)	Single	Pastry Bake	2	400	200	15-20
Phyllo	Single	Aero Bake	3	375-400	190-200	15-25
Flaky/puff	Single	Aero Bake or True Aero + Low steam	3	365-400	185-200	20-30
Choux	Single	Bake/Vent Bake	2	400-410	200-210	30-40
	Multi	True Aero	2 and 4	360-400	180-200	30-35
Croissants	Single	Bake/Vent Bake	3	375-400	190-200	15-25
	Multi	True Aero	2 and 4	375-400	190-200	15-25
PIES						
Fruit pie (double crust)	Single	Aero Bake	3	350-400	175-200	20-25
Pumpkin pie (blind baked, then filled)	Single	Classic Bake	2 or 3	350-375	175-190	15-30
Reheat pastry	Single	Crisp Regenerate	2	360	180	10-20
Baked cheesecake	Single	True Aero + Medium Steam	2 or 3	320	160	50-60
English custard tart (blind baked, then filled)	Single	Classic Bake	2 or 3	350-375	175-190	15-30

COOKING CHARTS

BROILING	SHELVES	FUNCTION	SHELF POSITION	TEMP (°F)	TEMP (°C)	TIME (MIN)
BEEF						
Steak, rare	Single	Aero Broil	4	445	230	10-15
Steak, medium	Single	Aero Broil	4	445	230	15-20
Burgers	Single	Maxi Broil	4	HI	HI	12-15
Meatballs	Single	Maxi Broil	4	HI	HI	12-15
LAMB						
Chops, medium	Single	Maxi Broil	4	HI	HI	15-20
Chops, well done	Single	Maxi Broil	4	HI	HI	20-25
CHICKEN						
Boneless pieces	Single	Aero Broil	5	350-375	175-190	30-50
PORK						
Chops, well done	Single	Maxi Broil	4	HI	HI	15-20
Ham steak	Single	Maxi Broil	4	HI	HI	15-20
Bacon	Single	Maxi Broil	4	HI	HI	4-7
SAUSAGES						
	Single	Maxi Broil	5	HI	HI	10-15
VEGETABLES						
Sliced	Single	Maxi Broil	4	HI	HI	8-12
TOAST						
10-15mm thick	Single	Maxi Broil	4	HI	HI	1-3

COOKING CHARTS

SAVOURY	SHELVES	FUNCTION	SHELF POSITION	TEMP (°F)	TEMP (°C)	TIME (MIN)
CORNBREAD	Single	Aero Bake	3	400-425	200-220	20-25
VEGETABLES	Single	Vent Bake	3	350-375	175-190	30-50
LASAGNE	Single	True Aero + Low Steam	3	350-375	175-190	35-40
QUICHE	Single	Pastry Bake	2	350	175	15-30
PIZZA						
Thin crust	Single	Pizza Bake	1 and 2	445	230	8-12
Deep dish	Single	Pizza Bake	1 and 2	320-430 ¹	160-220 ¹	50-60
CASSEROLES	Single	Slow Cook	2	250-300	120-150	2-4 hrs
POTATOES						
Traditional Baked	Single	Bake	3	390	200	50-60
FRITTATA						
Broil to finish	Single	Pastry Bake	3	340-360	170-180	30-45
OVEN MEALS	Single	Steam Regenerate	3	175-195	80-90	15-20
FISH						
Fillets	Single	Aero Broil	5	400-425	200-220	8-12
Fillets (crumbed)	Single	True Aero + Low Steam	3	400-425	200-220	8-12
Whole	Single	True Aero + Medium Steam	2	360-400	180-200	15-20

COOKING CHARTS

ROASTING	SHELVES*	FUNCTION	SHELF POSITION	TEMP (°F)	TEMP (°C)	TIME** (MIN)
BEEF, BONELESS (times per 1lb/450g)						
Rare	Single*	Roast/True Aero + Medium Steam	2	320-340	160-170	18-32
Medium	Single*	Roast/True Aero + Medium Steam	2	320-340	160-170	25-40
Well done	Single*	Roast/True Aero + Medium Steam	2	320-340	160-170	30-55
PRIME RIB ROAST (times per 1lb/450g)						
Rare	Single*	Roast/True Aero + Medium Steam	2	320-340	160-170	15-30
Medium	Single*	Roast/True Aero + Medium Steam	2	320-340	160-170	20-35
Well done	Single*	Roast/True Aero + Medium Steam	2	320-340	160-170	25-40
LAMB LEG, BONE IN (times per 1lb/450g)						
Medium	Single*	Roast/Vent Bake	2	320-340	160-170	18-28
Well done	Single*	Roast/Vent Bake	2	320-340	160-170	20-33
LAMB LEG, BONELESS (times per 1lb/450g)						
Medium	Single*	Roast/Vent Bake	2	320-340	160-170	20-35
Well done	Single*	Roast/Vent Bake	2	320-340	160-170	25-45
CHICKEN (WHOLE) (times per 1lb/450g)						
With stuffing	Single*	Roast/True Aero + Medium Steam	2	350-375	175-190	17-22
Without stuffing	Single*	Roast/True Aero + Medium Steam	2	350-375	175-190	15-20
Butterflied	Single*	Roast/True Aero + Medium Steam	2	350-375	175-190	15-20
TURKEY, WHOLE (times per 1lb/450g)						
With stuffing	Single*	Vent Bake/Bake	1	330-400	165-180	17-22
Without stuffing	Single*	Vent Bake/Bake	1	300-330	150-165	15-20
PORK CRACKLING						
Crisp		Vent Bake	3	445	230	20

COOKING CHARTS

ROASTING	SHELVES*	FUNCTION	SHELF POSITION	TEMP (°F)	TEMP (°C)	TIME** (MIN)
VEAL (times per 1lb/450g)						
Medium	Single*	Roast/Vent Bake	3	320-340	160-170	20-40
Well done	Single*	Roast/Vent Bake	3	320-340	160-170	25-45
PORK, BONELESS (times per 1lb/450g)						
Medium	Single*	Roast/Vent Bake	2	340-350	170-175	25-40
Well done	Single*	Roast/Vent Bake	2	340-350	170-175	30-45
VENISON (times per 1"/2.5cm thickness)						
Rare	Single*	Aero Broil ²	4	435	225	7.5
Medium	Single*	Aero Broil ²	4	435	225	9.5
AIRFRYING						
POTATOES	SHELVES*	FUNCTION	SHELF POSITION	TEMP (°F)	TEMP (°C)	TIME (MIN)
Hash browns	Single*	Air Fry	4	410	210	15-20
Fries	Single*	Air Fry	4	410	210	15-20
ONION RINGS	Single*	Air Fry	4	375	190	15-20
FISH						
Battered/crumbed	Single*	Air Fry	4	360	180	15-20
CHICKEN						
Nuggets	Single*	Air Fry	4	360	180	15-20

COOKING CHARTS

STEAMING	SHELVES	FUNCTION	SHELF POSITION	TEMP (°F)	TEMP (°C)	TIME (MIN)
VEGETABLES						
Root (Potatoes, carrots, beets, yams)	Single***	Steam	2	210	100	20-30
Leafy (Spinach, kale, chard)	Single***	Steam	2	210	100	6-10
PROTEIN						
Eggs (in shell)	Single***	Sous Vide	2	145	63	60-65
Steak, 10 oz (vacuum sealed, medium rare)	Single***	Sous Vide	2	131	55	60-70
Steak, 10 oz (vacuum sealed, medium)	Single***	Sous Vide	2	136	58	60-70
Fish fillet (Sole, snapper, cod)	Single***	Steam	2	160	70	15-25
Fish fillet (5 - 6 oz de-boned salmon)	Single***	Sous Vide	2	125	52	40-50
Whole fish (2 - 3 lb scaled & gutted)	Single***	Steam	2	185	85	40-50
Seafood (Clams/mussels)	Single***	Steam	2	210	100	6-10
Seafood (Whole raw prawns, large)	Single***	Steam	2	210	100	5-8
DIM SUM						
Yeast dough	Single***	Steam Proof	2	95	35	30-45
Fresh bao buns	Single***	Steam	2	210	100	10-15
Frozen meat filled buns	Single***	Steam	2	210	100	20-25
Fresh dumplings	Single***	Steam	2	210	100	10-15
Frozen dumplings	Single***	Steam	2	210	100	15-20

COOKING CHARTS

STEAMING	SHELVES	FUNCTION	SHELF POSITION	TEMP (°F)	TEMP (°C)	TIME (MIN)
DESSERTS						
Crème brulee	Single***	Steam	2	185	85	25-30
Crème Caramel	Single***	Steam	2	200	95	40-50
OTHER						
Cooked dim sums (Reheat)	Single***	Steam Regenerate	2	175	80	10-20
Frozen minced meat (1 lb / 450g)	Single***	Steam Defrost	2	140	60	40-60
Basmati rice (1 cup: 1.5 Cups water)	Single***	Steam	2	210	100	20-30
Yoghurt	Single	Steam	2	104-113	40-45	5-8hrs

¹ Start at 430°F (220°C) for 10 minutes, and lower to 320°F (160°C) for further 50 minutes

² Brown in frying pan first

* If multiple shelves are required (eg roasting vegetables at the same time), use **TRUE AERO** and shelf positions 2 and 4.

** Alternatively use the food probe and internal temperature settings or **COOK BY FOOD TYPE**.

***When steaming on a perforated pan/sheet, place solid stainless pan at a shelf position lower to collect cooking juices.

The information in these charts is for guidance only. Refer to your recipe or the packaging and be prepared to adjust the cooking times and settings accordingly.

USER PREFERENCE SETTINGS

The settings menu allows you to adjust your user preferences to:

- Change the time
- Change the clock format (12 hours, 24 hours or off)
- Display the temperature in degrees Celsius or Fahrenheit
- Adjust the volume of audio feedback
- Turn timer alarms on or off
- Turn audio tones on or off
- Operate in Sabbath Mode
- Change the language of the display
- Manage your WiFi connection
- Adjust the brightness of the display
- Manage dial settings*:
 - Change the dial scroll direction
- Adjust the water hardness level for the area you live in
- Select the mains supply voltage for your home
- Restore all settings to factory original

You cannot change the settings when your oven is cooking or has any automatic cooking options set.

Tones and alarms will still sound for faults if audio settings are turned off.

USER PREFERENCE SETTINGS

Changing the settings

1



Touch the menu icon in the top left corner of the screen.

2

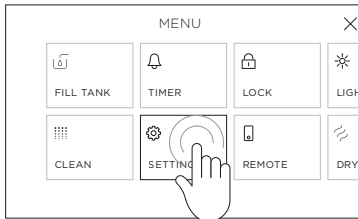

Select **SETTINGS**.

3

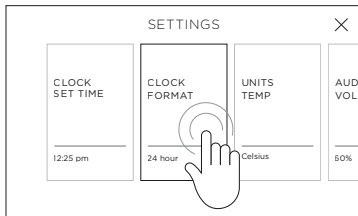

Select the setting you want to change, adjust as needed then select **CONFIRM**.

WIFI CONNECTION AND REMOTE MODE

Your oven can be connected to your home wireless network and operated remotely using the app.

Getting started

- Ensure your home WiFi network is turned on.
- You will be given step by step guidance on both your oven and mobile device.
- It may take up to 10 minutes to connect your oven.

Connecting to your home wifi

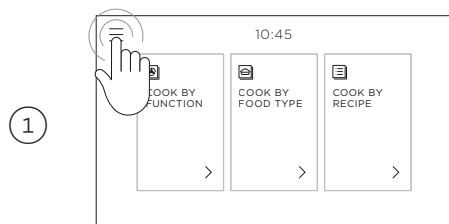

Touch the menu icon in the top left corner of the screen.

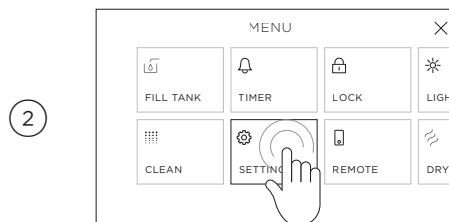

Select **SETTINGS**.

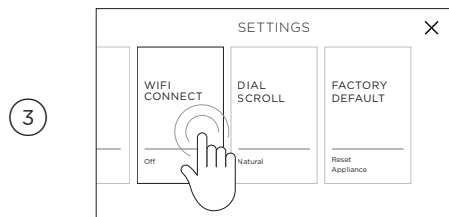

Select **WIFI CONNECT** and follow the onscreen guidance.

On your mobile device:

- ① Download the app from www.fisherpaykel.com/connect
- ② Register and create an account.
- ③ Add your appliance and set up the WiFi connection.

WIFI CONNECTION AND REMOTE MODE

Enabling Remote Mode

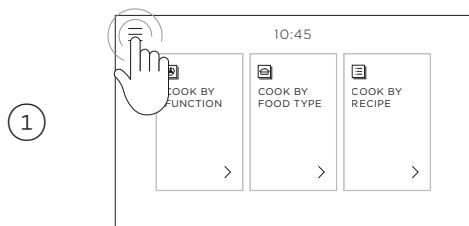

Touch the menu icon in the top left corner of the screen.

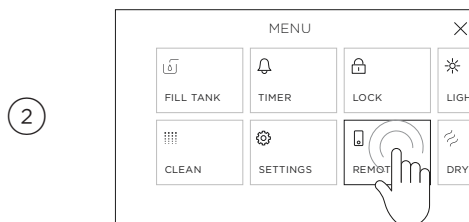

Select **REMOTE**.

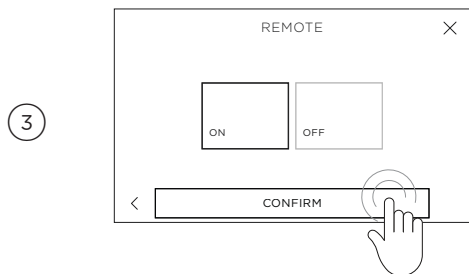

Select **ON** then press **CONFIRM**.
REMOTE MODE is now enabled.

SABBATH MODE

This setting is designed for religious faiths that observe a 'no work' requirement on the Sabbath.

While your oven is in Sabbath Mode it will not have the usual accurate temperature control:

HEAT LEVEL	APPROXIMATE TEMP (°C)	APPROXIMATE TEMP (°F)	APPLICATION
Low	75 - 100	170 - 210	Keep hot food warm
Moderate	155 - 180	310 - 360	Reheat cooked food from cold
High	185 - 210	360 - 410	Cooking raw food

Setting Sabbath Mode



In the settings menu select **SABBATH MODE** and follow the instructions on the screen.

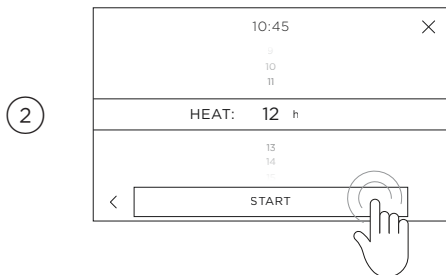

Set your desired heating level and select whether you want the oven light **ON** or **OFF** during cooking.

Scroll to set your desired cook time and then select **START**. You can set the oven to heat for up to 74 hours.

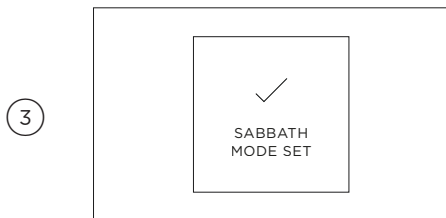

Sabbath Mode is now set.

The oven will heat for the set length of time and then turn off.

The oven will remain in Sabbath Mode until it is cancelled.

SABBATH MODE

Cancelling Sabbath Mode

1

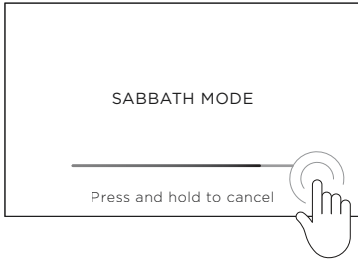

Touch and hold the screen until the bar fills.

2



SABBATH MODE CANCELLED will appear and you can now use your oven normally.

CARE AND CLEANING

Manual cleaning

ALWAYS

- Before any manual cleaning or maintenance, first wait for the oven to cool down to a safe temperature to touch, then turn its power supply off at the wall.
- Read these cleaning instructions and the “Safety and warnings” section before you start cleaning your oven.
- To prevent soiling from becoming ‘baked on’ and stubborn, we recommend removing any easy-to-reach spills, food or grease stains from the oven cavity enamel after each use.

NEVER

- Never use a steam cleaner.
- Never store flammable substances in the oven.
- Never use abrasive or harsh cleaners, cloths, scouring pads or steel wool. Some nylon scourers may also scratch. Check the label first.
- Never leave alkaline (salty spills) or acidic substances (such as lemon juice or vinegar) on the oven surfaces.
- Never use cleaning products with a chlorine or acidic base.

WHAT?

HOW?

IMPORTANT!

Control Panel

Take particular care when cleaning the control panel glass and screen. Only use a damp cloth with detergent.

Do not use any oven cleaners, harsh or abrasive cleaners, scouring pads, steel wool or sharp metal scrapers on the glass. These may scratch and damage the surface.

Dial

Clean with a solution of mild detergent and hot water, then wipe dry.

Do not use stainless steel or oven cleaner on the dial, as doing so may damage its coating.

Stainless steel strip/oven door handle*

Clean with a solution of mild detergent and hot water, then wipe dry with a microfibre cloth. If necessary, use a suitable stainless steel cleaner and polish.

Always read the label to make sure that your stainless steel cleaner does not contain chlorine compounds as these are corrosive and may damage the appearance of your oven. Always rub the stainless steel in the direction of the grain.

Food probe

Clean with a solution of mild detergent and hot water, then wipe dry with a microfiber cloth.

- Clean after every use to avoid contamination.
- Do not wash in the dishwasher, immerse in soapy water or use oven cleaner on it.

CARE AND CLEANING

WHAT?	HOW?	IMPORTANT!
Oven door frame and plastic corner clips	Clean with a solution of mild detergent and hot water, then wipe dry.	
Oven cavity	<p>To clean light soiling off the enamelled surfaces:</p> <ul style="list-style-type: none"> • Wipe with a damp cloth and a solution of hot water and mild detergent or an ammonia-based cleaner. • Wipe dry with a soft cloth. <p>After steam cooking, wait for the oven to cool then wipe out any moisture from the bottom of the cavity.</p> <p>After wiping out the oven, we recommend running a dry cycle to remove any remaining moisture.</p>	<ul style="list-style-type: none"> • To prevent soiling from becoming 'baked on' and stubborn, we recommend removing any easy-to-reach spills, food or grease stains from the enamelled surfaces after each use. • To make wiping out the oven easier you may remove the oven door. See the following pages for more information. • To help lift stubborn spills, run the steam clean cycle before wiping out the oven.
Full extension sliding shelf	Wipe with a damp cloth and mild detergent. Do not wipe off or wash away the white lubricating grease (visible when the shelf is extended).	Do not wash the shelf in the dishwasher, immerse in soapy water, or use oven cleaner on it. Doing so will prevent the slides from running smoothly.
Grid Broil rack Broil pan Wire oven shelves Side racks	Clean with a solution of mild detergent and hot water.	
Perforated pans Solid pan	Clean with a solution of mild detergent and hot water.	Do not wash in the dishwasher.

CARE AND CLEANING

WHAT?	HOW?	IMPORTANT!
Oven seal	Do not clean this part.	<ul style="list-style-type: none">• Take care not to rub, damage or move the oven seal.• Do not remove this part.
Oven door glass (after every use)	<p>Use a soft cloth and a mixture of warm water and dishwashing liquid to remove soiling after every use.</p> <p>For stubborn stains, try a mixture of baking soda and warm water with a non-abrasive scrubbing pad, then wipe dry with a soft, lint-free cloth.</p>	<ul style="list-style-type: none">• Do not use oven cleaners or any other harsh/abrasive cleaners, cloths, scouring pads, steel wool or sharp metal scrapers to clean the oven door glass. These scratch the glass, which in turn could result in the glass cracking and shattering.• Only a Fisher & Paykel trained and supported service technician can take apart the door.• Do not attempt to take the door apart for cleaning. If the inner panes of glass in the door become dirty, please contact a Fisher & Paykel trained and supported service technician or Customer Care.

CARE AND CLEANING

Removing the side racks

Remove the side racks to make cleaning the oven easier.

Always turn the oven off at the wall first. Ensure the oven has cooled down completely before starting.

1

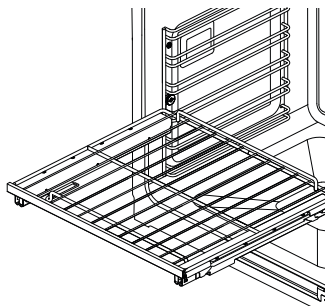

Slide out all shelves and remove.

2

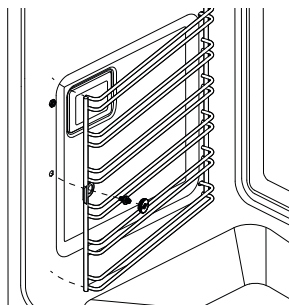

Unscrew and remove the fixing nut at the front of the side rack. Use a coin to loosen the nut if necessary.

Pull the front of the rack toward the back of the oven until the front tab is clear of the fixing nut.

3

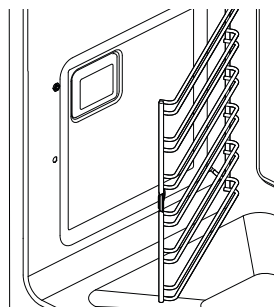

Slide the side rack forward until the rear tabs are clear of the mounting studs.

CARE AND CLEANING

Refitting the side racks

1

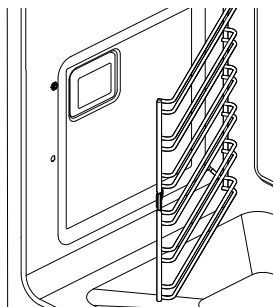

Slide the rear tabs of the side rack back onto the mounting studs, ensuring the rack is firmly pushed up against the side wall of the oven.

2

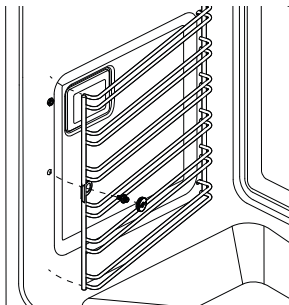

Fit the side rack front tab over the fixing screw.

Replace the fixing nut. You may use a coin to tighten the nut.

CARE AND CLEANING

Replacing the oven light bulbs

- Your oven uses G9 halogen bulbs with the specifications 120V, 50Hz and 25W.
- To replace the oven light bulbs, contact Customer Care or go to our website www.fisherpaykel.com
- Oven bulb replacement is not covered by your warranty.

CARE AND CLEANING

Removing and refitting the oven door.

To remove the door

1

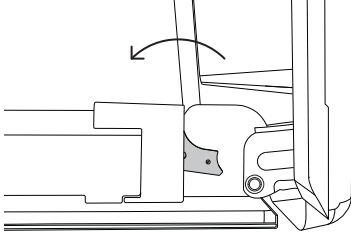

Take care, the oven door is heavy.

Open the door fully.

Locate the two small metal locking levers on both door hinges either side.

2

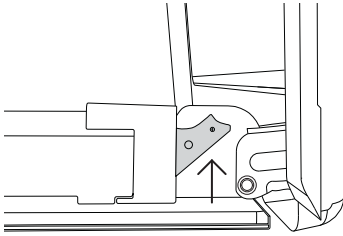

Push each locking lever up fully to release the door from the hinge.

3

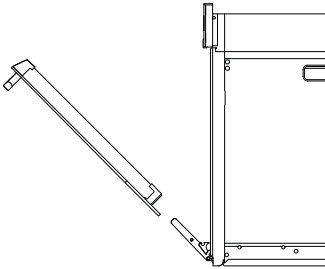

Holding the door on both sides, lift door back up to 45° and carefully pull the door out and away from the hinges.

CARE AND CLEANING

To refit the door

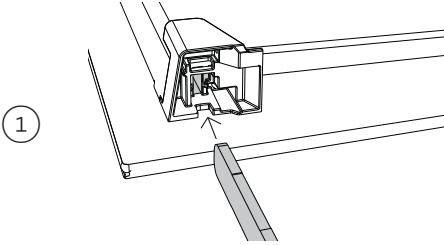

Holding the door on both sides, line up the holes in the base of the door with the hinges and slide the door on.

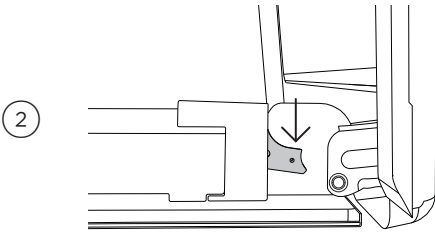

Ensure the door is firmly in place on the hinges. Open the door fully again and push each locking lever down to lock the door onto the hinge.

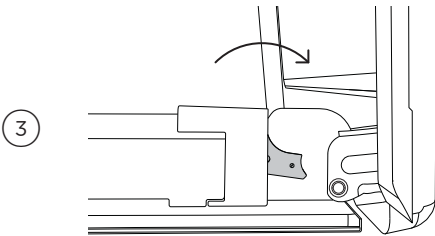

Ensure the levers are both fully locked before trying to shut the door.

DESCALING THE OVEN

Descal your ovens steam generator as soon as possible after the descale alert is shown. Failure to do this may cause the steam functions to become unusable. The descale process takes approximately 40 minutes.

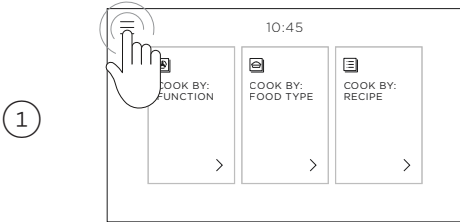

Touch the menu icon at the top left corner of the home screen.

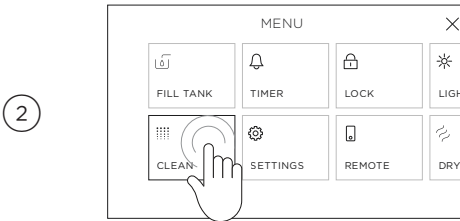

Select **CLEAN**.

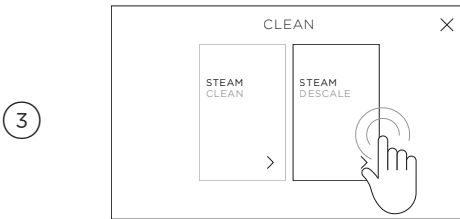

Select **STEAM DESCALE**.

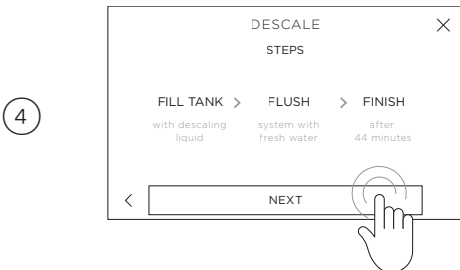

Touch **NEXT** to continue.

DESCALING THE OVEN

5



Fill tank with 4 cups (1L) of descaling solution* and select **FILL TANK** to begin process.

6

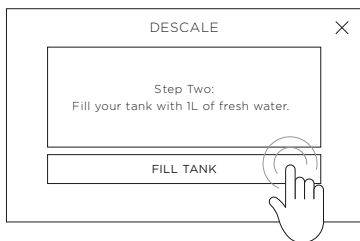

Fill tank with 4 cups (1L) of fresh water and select **FILL TANK** to flush the tank.

7

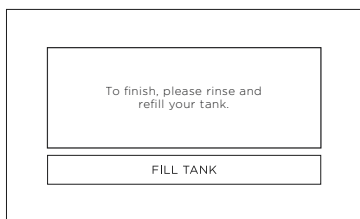

Select **FILL TANK** to complete the descaling process and return to the main menu.

After the Descale cycle is complete, wipe the base of the cavity to remove any excess moisture.

*3 oz (80 grams) (1/3 cup) of citric acid powder to 4 cups (1L) of warm water. Take care when handling citric acid. Ensure you read and follow the manufacturer's instructions carefully.

USING STEAM CLEAN

To help lift stubborn spills, run the steam clean cycle before wiping out the oven. For best results, oven should be around room temperature before beginning.

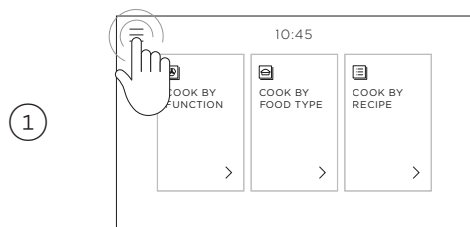

Touch the menu icon at the top left corner of the home screen.

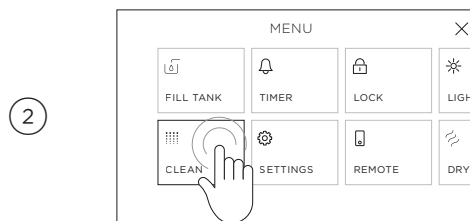

Select **CLEAN**.

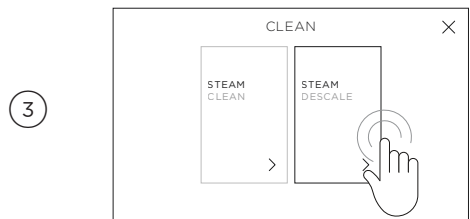

Select **STEAM CLEAN**, then **NEXT** to begin.



Fill tank with 1L of fresh water and select **FILL TANK** to begin.

TROUBLESHOOTING

If there is a problem with your oven, please check the following points before contacting your local Fisher & Paykel trained and supported service technician or the Customer Care Centre.

General

PROBLEM	POSSIBLE CAUSES	WHAT TO DO
The oven does not work.	No power.	Check that the mains power supply (wall switch) is turned on, the fuse has not tripped and there is no power outage in your area.
The oven does not work but the screen is on.	The oven is in Demo Mode.	Call Customer Care.
The lights do not come on when I open the oven door.	The oven light bulb(s) have blown.	Call Customer Care to arrange replacing the light bulb(s). See 'Care and cleaning' for instructions.
	The door is not correctly fitted.	See 'Care and cleaning' for instructions on fitting the door correctly.
	The oven light has been turned off.	Go to the menu in the top left corner of the screen and select LIGHT .
The oven controls are unresponsive.	The control panel is locked.	Touch and hold the screen to unlock.
The oven is not heating.	The door is not properly closed or it is opened too frequently during cooking.	The heating elements are disabled while the door is open. Make sure the door is properly closed and avoid opening it frequently during cooking.
A glass pane in the oven door has cracked, chipped, or shattered.	Incorrect cleaning or the edge of the glass hitting against something.	You must NOT use the oven. Contact a Fisher & Paykel trained and supported service technician or Customer Care
I can feel hot air blowing out of the vents after I have turned the oven off.	This is normal.	For safety reasons the cooling fans will continue to run even when you have turned the oven off. The fans will switch off automatically when the oven has cooled.

TROUBLESHOOTING

General

PROBLEM	POSSIBLE CAUSES	WHAT TO DO
The oven fan comes on when I select a function that does not use a fan (eg BAKE or CLASSIC BAKE).	This is normal. The fan comes on while the oven is preheating. It may turn off when the oven has reached the set temperature.	Wait until the red heating bar on the screen disappears: the oven will then be ready to use.
The oven has reached the set temperature but the temperature dial halo is still red*.	The oven is set to MAXI BROIL .	This is normal. The dial halo* will stay red whenever this function is in use as the broil element is always heating.
The oven sounds a tone when I try to set the temperature below a certain temperature.	This is normal: for food safety reasons, the oven functions have factory-set minimum temperature settings.	Select a different temperature or try a different function that is designed for low temperatures.
The temperature dial halo never turns white when I use MAXI BROIL*.	This is normal: the halo stays red to indicate that the broil element provides instant radiant heat.	
Control panel stops during travel/or doesn't travel when activated.	<ul style="list-style-type: none"> • Moving control panel obstructed • Motor or gear failure 	<ul style="list-style-type: none"> • Check for any obstructions • Firmly push control panel with two hands to return to home position. If not movable by hand, contact a Fisher & Paykel trained and supported service technician or call Customer Care.
Cannot open control panel.	Door is open.	Ensure oven door is closed correctly.
'Tank level too low' displays on screen when water tank appears to have enough water.	This is normal.	Fill tank to maximum capacity.
Drip tray is overflowing.	Drip tray is full.	Open the door to access the drip tray. Empty tray either by sponge, or by lifting it from the product.
FILL TANK button is unavailable.	Water is being pumped from generator back into tank.	Button will become available once operation is complete.
Gurgling & spluttering noises from product.	This is normal as the water boils.	
Steam functions are unavailable.	<ul style="list-style-type: none"> • Descale required • Tank not installed correctly • Tank level too low 	Refer to screen for cause and follow onscreen guidance to correct.

*some models only

TROUBLESHOOTING

General

PROBLEM	POSSIBLE CAUSES	WHAT TO DO
Water present in the bottom of the oven after running a steam function	This is normal.	<ul style="list-style-type: none">• Wait for oven to cool then wipe out base of cavity.• Always run a dry cycle after using a steam function.
Burnt smell coming from cavity base.	<ul style="list-style-type: none">• Burnt descale solution.• Burnt food residue.	<ul style="list-style-type: none">• Clean oven• Ensure a solid tray is used below perforated pan to catch residue.
Water stain after dry cycle.	Water hardness.	Ensure oven cavity is wiped clean regularly.

ALERT CODES

If there is a problem, the oven will automatically suspend all oven functions, beep five times and display an alert code.

Do not turn off the mains power supply to the oven (wall switch) if you get an alert code, unless the instructions in the chart following specifically instruct you to. There are cooling fans within the oven which are needed to cool the oven's components. Turning off the power while the oven is too hot may damage the oven and its surrounding cabinetry.

What to do if an alert code is displayed

- ① If the beeping hasn't stopped already, touch the display and press the little audio button in the bottom right to mute it.
- ② Make a note of the alert code displayed. You may need this information.
- ③ Follow the instructions on the screen to resolve the problem.
- ④ If you can fix the problem and the alert code does not reappear, you may continue using your oven.

If you can't fix the problem yourself or the alert code reappears and the problem persists: wait until the cooling fans have stopped and the oven has completely cooled down, then turn the power to the oven off at the wall and contact a Fisher & Paykel trained and supported service technician or Customer Care with the alert code information.

ALERT CODE	POSSIBLE CAUSES	WHAT TO DO
A1	The oven has overheated.	<ul style="list-style-type: none">• Allow the oven to cool down.• Once the oven has cooled down and the door has unlocked, the alert code will disappear. You can now use the oven.
F + number	Technical fault.	<ul style="list-style-type: none">• Note down the alert code.• Wait until the cooling fans have stopped and the oven has completely cooled down.• Turn the power to the oven off at the wall.• Contact a Fisher & Paykel trained and supported service technician or Customer Care.

WARRANTY AND SERVICE

Before you call for service or assistance

Check the things you can do yourself. Refer to the installation instructions and your user guide and check that:

- Your product is correctly installed.
- You are familiar with its normal operation.

If after checking these points you still need assistance or parts, please refer to the Service & Warranty book for warranty details and your nearest Authorized Service Center, Customer Care, or contact us through our website www.fisherpaykel.com

Complete and keep for safe reference:

Mode _____
Serial No. _____
Purchase Date _____
Purchaser _____
Dealer _____
Suburb _____
Town _____
Country _____

FISHERPAYKEL.COM

© Fisher & Paykel Appliances 2023. All rights reserved.

The models shown in this guide may not be available in all markets and are subject to change at any time.

The product specifications in this guide apply to the specific products and models described at the date of issue. Under our policy of continuous product improvement, these specifications may change at any time.

For current details about model and specification availability in your country, please go to our website or contact your local Fisher & Paykel dealer.

431316A 12.23