

# 60cm Series 9 Integrated Wine Cabinet

Series 9 | Integrated

Panel Ready | Right Hinge



Designed for wine lovers, this under-counter, panel-ready wine cabinet seamlessly blends into any space of the evolving home. With dual temperature zones and specialised modes, it provides optimal conditions for all wine types.

- With two independent temperature zones to cater for different wine varieties
- Four specialised wine modes for Red, White, Sparkling, and Cellar wines

- Accommodates up to 35 bottles, providing ample space for a diverse collection
- Panel ready and flush fit, with 4mm gaps and no visible hinges or grilles

## DIMENSIONS

Height	864 mm
Width	592 mm
Depth	576 mm

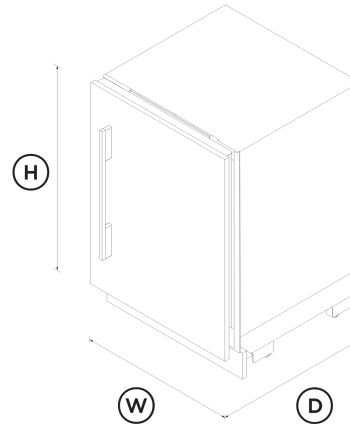

## FEATURES & BENEFITS

### Complete Design Freedom

This sleek under-counter wine cabinet enhances any space, from kitchens to home bars, rumpus rooms to home cinemas. Compact and stylish, it is a sophisticated, space-efficient solution for wine enthusiasts looking to add elegance and accessibility to their home. Pairs perfectly with our Beverage Centre to create an entertainer's dream set-up.

### Optimal Wine Care

To provide the perfect storage environment for your wine collection, this cabinet has been engineered to maintain a consistent temperature across two independently-controlled zones. An activated carbon filter in each compartment clears the air of pollutants, ensuring your wine is perfectly preserved.

### Precise Temperature Control

Four tailored wine modes offer optimal temperatures for serving and cellaring different types of wine: Red, White, Sparkling, and Cellar. These modes ensure each variety can receive the care it needs to be enjoyed at its best. Manual temperature adjustments are possible in 0.5°C increments between 6-18°C.

### Reduced Vibration

Vibration can dull flavour and cause other unwanted issues in wine. This cabinet features a quiet, low-vibration compressor, full-extension slides with white oak shelving, and other strategically chosen absorptive materials to help carefully maintain the flavour profile of every drop.

### Seamless Fit

These panel-ready models are designed to fit flush, with only 4mm gaps between the wine cabinet and surrounding cabinetry, and no visible hinges or grilles. They can be seamlessly hidden behind cabinetry, or choose our tinted glass model instead to put your collection proudly on display.

### Simple Installation

Our Integrated products are easy to install, whether you are renovating your kitchen or designing a new one. Adjustable front and rear feet allow for uneven floors alongside adjustable door panels that can be customised to match your kitchen. These models are designed to easily slide into place under your counter - a perfect fit for European-design kitchens.

## SPECIFICATIONS

### Accessories (sold separately)

Door panel stainless steel	<b>Left (Solid) RD6009L, Right (Solid) RD6009R</b>
Handle kit Classic	<b>AHCLRD09</b>
Handle kit Contemporary round	<b>AHSRD09</b>
Handle kit Contemporary square fine, aluminium	<b>AHD5RD09</b>
Handle kit Contemporary square fine, black	<b>AHD5RD09B</b>
Handle kit Professional round flush	<b>AHP3RD09</b>
Joiner kit	<b>AJRS09LR</b>
Toe kick stainless steel 1200mm	<b>AKRS12010</b>
Toe kick stainless steel 600mm	<b>AKRS06010</b>
Wine display label Kit (14 labels with white pencil)	<b>ALV14</b>
Wine filter odour kit	<b>863974</b>

### Capacity

Number of bottles	<b>35</b>
-------------------	-----------

### Features

Air filter lower compartment	•
------------------------------	---

Air filter upper compartment	•
Door alarm	•
Full extension storage racks	<b>5</b>
LED lighting	•
Low vibration compressor	•
Removable solid oak shelves	<b>5</b>
Smart appliance	•
Soft-mounted wine racks	•
Telescopic slide out oak shelves	<b>5</b>

### Performance

ActiveSmart™ wine care	•
Air circulating fans	•
Door opening	<b>right hand hinge</b>
Dual evaporator	•
Dual Zone	•
Noise emissions	<b>34 dBA</b>
Sabbath mode	•
Temperature range	<b>6-18 degrees Celcius</b>
Variable temperature zones	<b>2</b>
Variable wine modes	<b>Red, White, Sparkling, Cellar</b>

### Power requirements

Rated current	<b>10 A</b>
Supply frequency	<b>50 Hz</b>
Supply voltage	<b>220-240 V</b>

### Product dimensions

Depth	<b>576 mm</b>
Height	<b>864 mm</b>
Width	<b>592 mm</b>

### Warranty

Parts and labour	<b>2 years</b>
Sealed system parts only	<b>5 years</b>

SKU	26701
-----	-------

The product dimensions and specifications in this page apply to the specific product and model. Under our policy of continuous improvement, these dimensions and specifications may change at any time. You should therefore check with Fisher & Paykel's Customer Care Centre to ensure this page correctly describes the model currently available. © Fisher & Paykel Appliances Ltd 2020

### Other product downloads available at fisherpaykel.com

- [↓](#) 2D-DWG
- [↓](#) 2D-DXF
- [↓](#) Service & Warranty
- [↓](#) Installation Guide EN
- [↓](#) Planning Guide Wine Cabinet & Beverage Centre
- [↓](#) Revit 19
- [↓](#) User Guide Integrated Wine Cabinet

Where applicable:

All appliances use energy, and energy usage typically generates carbon emissions. **Fisher & Paykel Appliances' In-use Energy Carbon Emissions Estimate** indicates carbon emissions from a product's in-use energy. This is calculated either annually or per cycle, using the product's market-specific energy label energy consumption data multiplied by the carbon emissions factor for energy in your country or region.

Our In-use Energy Carbon Emissions Estimate is designed to assist customers in making informed purchasing decisions when comparing different Fisher & Paykel products. For example, a heat pump dryer typically has a lower In-use Energy Carbon Emissions Estimate than a vented dryer.



**A PEACE OF MIND SALE**  
24 Hours 7 Days a Week Customer Support  
T 0800 372 273 W [www.fisherpaykel.com](http://www.fisherpaykel.com)