

FISHER & PAYKEL

BUILT-IN OVEN

OB90 models

USER GUIDE

NZ AU

CONTENTS

Safety and warnings	2
Introduction	12
The control panel	13
Setting the clock and first use	14
Using your oven	16
Oven functions	18
Using the rotisserie	20
Using the timer	22
Automatic cooking	23
Cooking chart	25
User preference settings	26
Sabbath setting	28
Care and cleaning	30
Troubleshooting	39
Alert codes	41
Warranty and service	42

IMPORTANT!

SAVE THESE INSTRUCTIONS

The models shown in this user guide may not be available in all markets and are subject to change at any time. For current details about model and specification availability in your country, please go to our website www.fisherpaykel.com or contact your local Fisher & Paykel dealer.

SAFETY AND WARNINGS

Your oven has been carefully designed to operate safely during normal cooking procedures. Please keep the following safety instructions in mind when you are using it:

⚠ WARNING!



Electrical Shock Hazard

Turn the oven off at the wall before replacing the oven lamp. Failure to follow this advice may result in electrical shock or death.

⚠ WARNING!



Fire Hazard

Do not place aluminium foil, dishes, trays, water or ice on the oven floor during cooking, as doing so will irreversibly damage the enamel; lining the oven with aluminium foil may even cause fire.

Never use your appliance for warming or heating the room.

Persons could be burned or injured or a fire could start.

Storage in or on appliance: flammable materials should not be stored in an oven or near its surface.

Failure to follow this advice may result in overheating, burning, and injury.

⚠ WARNING!**Hot Surface Hazard**

Accessible parts may become hot when in use.

To avoid burns and scalds, keep children away.

Use oven mitts or other protection when handling hot surfaces such as oven shelves or dishes.

Use care when opening the oven door.

Let hot air or steam escape before removing or replacing food.

Do not touch heating elements or interior surfaces of the oven.

Heating elements may be hot even though they are dark in colour. Interior surfaces

of an oven become hot enough to cause burns. During and after use, do not touch, or let clothing or other flammable materials contact heating elements or interior surfaces of the oven until they have had sufficient time to cool.

Other surfaces of the appliance may become hot enough to cause burns - among these surfaces are the oven vent, the surface near the oven vent, and the oven door.

Failure to follow this advice could result in burns and scalds.



⚠ WARNING!



Cut Hazard

Take care - some edges are sharp.

Failure to use caution could result in injury or cuts.

IMPORTANT SAFETY INSTRUCTIONS

To reduce the risk of fire, electrical shock, injury to persons or damage when using the oven, follow the important safety instructions listed below:

- Read all the instructions before using the oven. Use the oven only for its intended purpose as described in these instructions.**
- Proper installation: be sure your appliance is properly installed and earthed by a qualified technician.**
- Isolating switch: make sure this oven is connected to a circuit which incorporates an isolating switch providing full disconnection from the power supply (under overvoltage category III conditions). The isolating switch must be of an approved type and provide a 3mm air gap contact separation in all poles.**
- Household appliances are not intended to be played with by children and children should be supervised to ensure that they do not play with the appliance.**

- **Do not leave children alone. Children should not be left alone or unattended in the area where the appliance is in use. They should never be allowed to sit or stand on any part of the appliance.**
- **Children of less than 8 years old must be kept away from the appliance unless continuously supervised. This appliance can be used by children aged from 8 years and above, and persons with reduced physical, sensory or mental capabilities or lack of experience and knowledge, if they have been given supervision or instruction concerning the use of the appliance in a safe way and they understand the hazards involved. Cleaning and user maintenance shall not be done by children without supervision.**
- **Do not place heavy objects on the oven door.**
- **Wear proper apparel. Do not wear loose fitting or hanging garments when using the appliance. They could ignite or melt if they touch an element or hot surface and you could be burned.**

- **User servicing: do not repair or replace any part of the appliance unless specifically recommended in the manual. All other servicing should be referred to a qualified technician.**
- **Do not use water on grease fires. Smother the fire or flame or use a dry chemical or foam type extinguisher.**
- **Use only dry oven mitts or potholders. Moist or damp potholders on hot surfaces could result in burns from steam. Do not let potholders touch hot areas or heating elements. Do not use a towel or a bulky cloth for a potholder. It could catch fire.**
- **Do not heat unopened food containers. They can build up pressure that may cause the container to burst and result in injury.**
- **Safe food handling: leave food in the oven for as short a time as possible before and after cooking. This is to avoid contamination by organisms which may cause food poisoning. Take particular care during warm weather.**
- **Always keep oven vents unobstructed.**
- **Do not operate your appliance by means of an external timer or separate remote-control system.**

- **Caution: Hot air can blow from the vent at the top of the oven as part of the oven's cooling system.**
- **Placement of oven shelves: always position shelves in the desired location while the oven is cool (before preheating). If a shelf must be removed while the oven is hot, do not let the oven mitts or potholder contact hot heating elements in the oven or the base of the oven.**
- **Do not clean the oven seal or use any oven-cleaning products on it. It is essential for a good seal, which ensures that the oven operates efficiently. Care should be taken not to rub, damage or move it.**

- **Do not use oven cleaners, harsh/abrasive cleaning agents, waxes, or polishes. No commercial oven cleaner, oven liner, or protective coating of any kind should be used in or around any part of the oven. Do not use harsh/abrasive cleaners, scourers or sharp metal scrapers to clean the oven door glass since they scratch the surface, which may result in the glass shattering.**
- **Clean only the parts listed in this manual.**
- **Do not use a steam cleaner to clean any part of the oven.**

- **Do not store things children might want above the oven. Children could be burned or injured while climbing on the oven to retrieve items.**
- **Do not install or operate the appliance if it is damaged or not working properly. If you receive a damaged product, contact your dealer or installer immediately.**
- **Use only bakeware approved for oven use. Follow the bakeware manufacturer's instructions.**

INTRODUCTION

Congratulations on your new purchase. Your oven has a number of features to make cooking a great experience for you:

- a choice of nine oven functions, including Rotisserie
- intuitive electronic controls and displays
- illuminated halos around the dials for visual feedback
- preference settings – see ‘User preference settings’ and ‘Sabbath setting’.

Before you start

- Make sure the installer has completed the ‘Final checklist’ in the Installation instructions.
- Read this guide, taking special note of the ‘Safety and warnings’ section.
- Remove all the packaging and check that you have all the accessories listed below.
- Make sure you follow the instructions under ‘Setting the clock and first use’ before using your oven for cooking or baking.

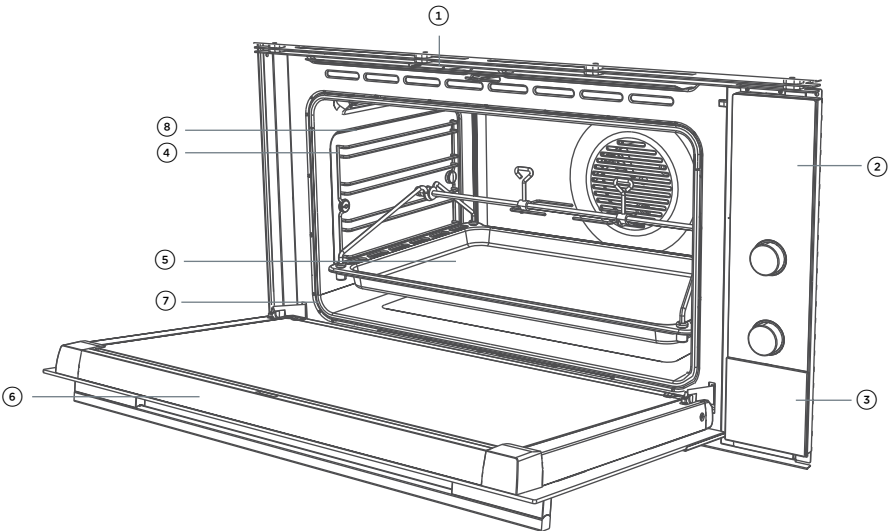

- ① Oven vent louvres
- ② Control panel
- ③ Stainless steel strip
- ④ Side racks
- ⑤ Grill tray and rotisserie
- ⑥ Oven door and handle
- ⑦ Oven seal
- ⑧ Catalytic panels

Not illustrated:

- Baking tray
- Step-down oven shelf
- Oven shelf
- Grill rack
- Sliding shelf supports

THE CONTROL PANEL

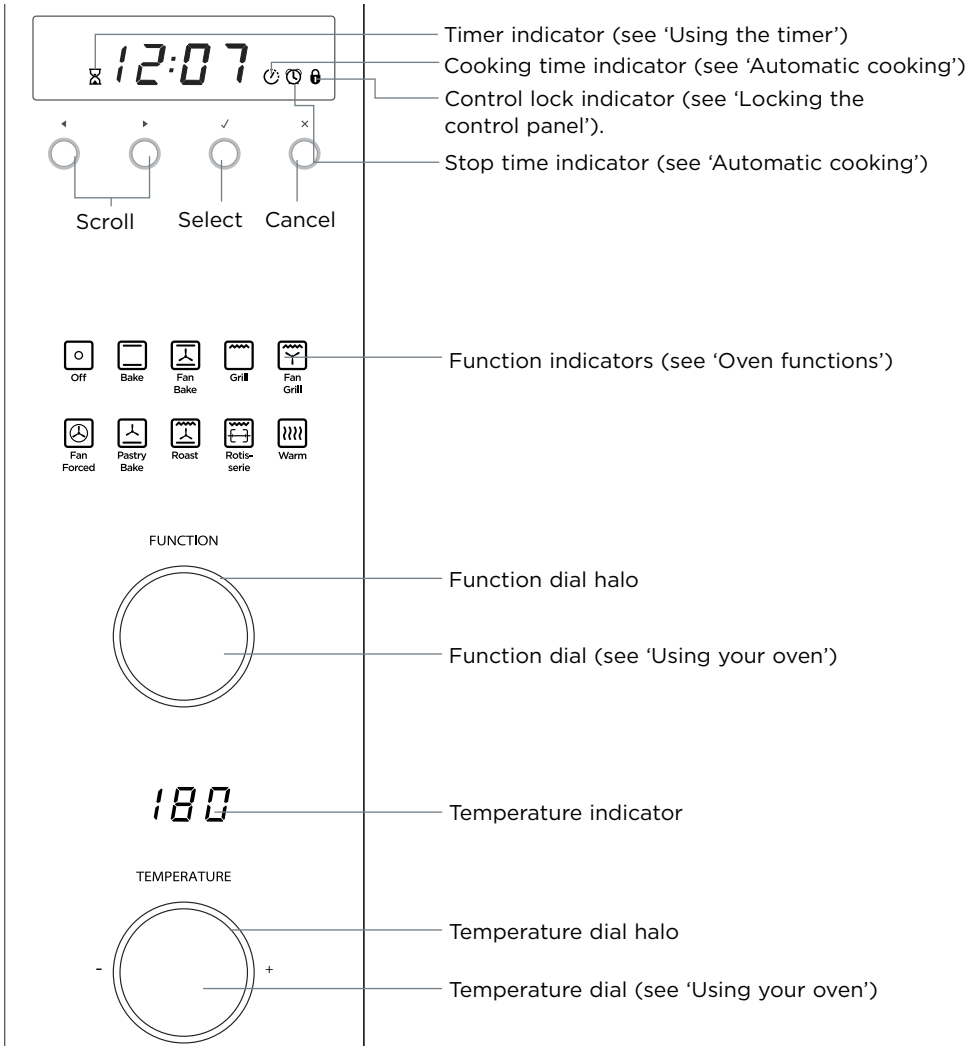

Locking the control panel

You can lock the control panel to prevent unintended use (eg children playing with the oven). Doing so will disable the dials and all the buttons.

To lock the control panel

- ① Make sure the oven is not in use (the function dial is turned to Off) and neither automatic cooking nor the timer is set (no indicator is lit in the display).
- ② Press and hold the select ✓ button until the lock indicator  comes on.

To unlock the control panel

Press and hold the cancel × button until the lock indicator  flashes and then goes out.

Setting the Clock

When your oven is first turned on, or after a power cut, the display will flash . You will need to set the clock in order to use the oven.

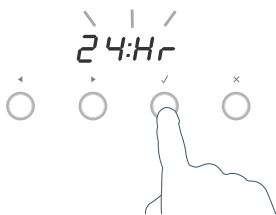

- ① The display will flash 24 Hr



- ② Press the right scroll ► button to scroll between 24 Hr and 12 Hr
③ Press the select ✓ button to confirm.

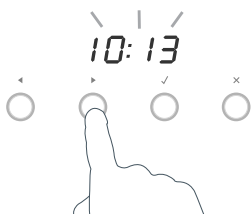

- ④ Press the left and right scroll ◀ ▶ buttons to set the time.

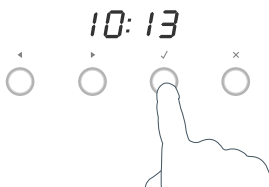

- ⑤ Press the select ✓ button to confirm.
• The time set will now be steadily lit.

FIRST USE

To change the time

You set the clock within the user preference menu.

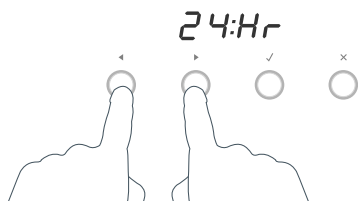

- ① To enter the user preference menu press and hold the left and right scroll ◀ ▶ buttons together for 3 seconds.
 - The display will either flash *12 Hr* or *24 Hr*
- ② Press the select ✓ button to confirm. The display will flash.

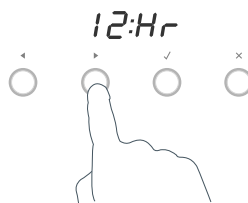

- ③ Press the right scroll ▶ button to scroll between *24 Hr*, *12 Hr* or *OFF* to turn the display off (see 'Setting User preferences' for more information).
- ④ Press the select ✓ button to confirm.

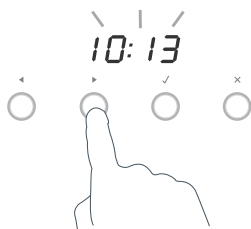

- ⑤ Press the left and right scroll ◀ ▶ buttons to set the time.
- ⑥ Press the select ✓ button to confirm.

USING YOUR OVEN

Fitting the side racks and catalytic panels

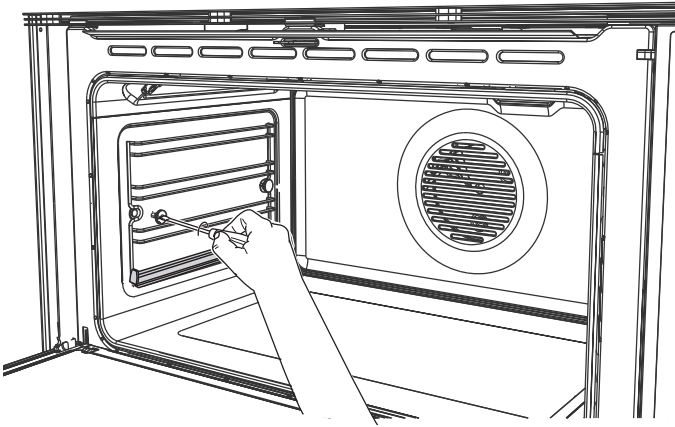

- ① Remove all shelves and trays.
- ② For easier access to the fixing screws, you may remove the oven door first. See 'Removing and refitting the oven door.'
- ③ Using a small coin or a flat-head screwdriver, loosen and remove the front fixing screw (the back lock stud cannot be removed), as shown.
- ④ Remove the side rack.
- ⑤ Fit the catalytic panel. When fitting the side catalytic panels, make sure that:
 - you slide the panel in, with the cutout in the panel fitting behind the back lock stud.
 - the arrows are pointing upwards
 - the panel with the round hole is on the right oven wall.
- ⑥ Refit the side racks.
 - Slide the side rack gently so it engages with the rear lock stud.
 - Make sure that they are the right way up, as in the illustrations, and then insert and tighten the front fixing screw.
- ⑦ If not already fitted, fit the telescopic sliding shelf supports. See 'Care and cleaning' for instructions.

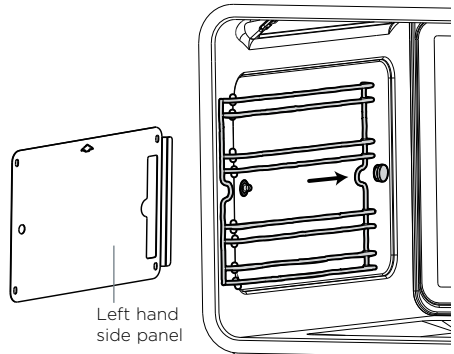

USING YOUR OVEN

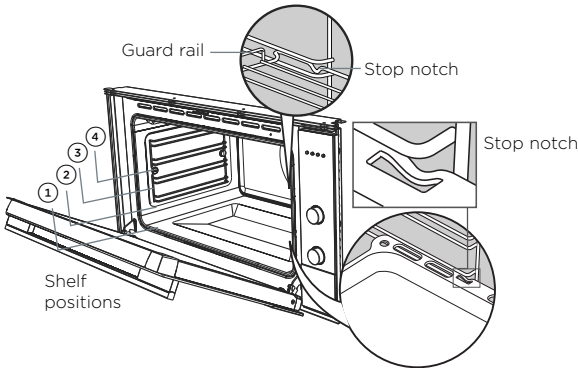

- ① Slide in the shelves you will need, making sure that:
- they are between the two wires of a shelf position
 - the stop notches point down
 - the guard rail is at the back.
 - Note: the grill tray should be positioned on the sliding shelf supports, or between the two wires of a shelf position and orientated as shown.
 - if the sliding shelf supports are not already fitted see 'Care and cleaning' for instructions.



FUNCTION

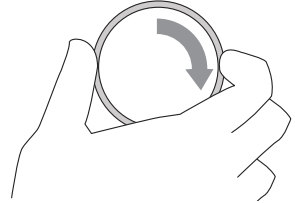

- ② Select a function.
- The halo will glow white.



FUNCTION

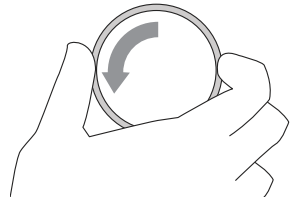

200 ----- 200

TEMPERATURE

TEMPERATURE

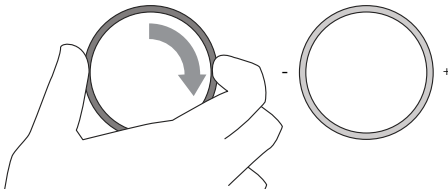

- ③ Set the temperature.
- While the oven is heating up, the halo will glow red and the temperature indicator will alternately show the actual and set temperatures.
 - When the oven has reached set temperature, a long tone will sound and the halo will turn white.
 - Note: Grill provides instant radiant heat, so the halo will stay red and there will be no tone.

OFF

TEMPERATURE



- ④ When you have finished cooking, turn the function dial to Off.

OVEN FUNCTIONS



Off

Selecting this will turn the oven off.



Bake

This is the traditional method of baking. It is best to bake on only one shelf at a time in this function. Ideal for large cakes and dishes that bake for several hours.



Fan Bake

Ideal for dishes like lasagne that need to brown on top and also single trays of small cakes or biscuits that bake in less than an hour.



Grill

Grill is the most suitable function for 'finishing off' many meals, for example browning the top of potato gratin and frittata. Use Grill to toast bread or to grill your favourite chicken, fish and steak. Note: heat levels are from LO (50% power) to HI (100% power), with settings from 1 to 9 in between. Grill provides instant radiant heat, so the temperature dial halo will stay red.



Fan Grill

Ideal for roasting tender cuts of meat and poultry. Use the lower shelf positions for larger items eg a whole chicken.



Fan Forced

Great for multi-shelf cooking. The consistent temperature ensures baking is well risen. Cookies baked on Fan Forced are crisp on the outside and chewy in the middle.



Pastry Bake

Excellent for sweet and savoury pastry foods, for moist breads and brownies and cookies that you want extra chewy.



Roast

No pre-heating of the oven required. The meat is seared during an initial 20-minute grilling stage, then baked at the set temperature for the rest of the time, producing a tender, juicy, and flavourful roast. Great for roasting vegetables too.

OVEN FUNCTIONS



Rotisserie

Rotisserie is a delicious way to cook meat and poultry. The slowly rotating food is basted continuously in its own juices, making it tender on the inside and well browned and full of flavour on the outside. See 'Using the rotisserie'.



Warm

Use this function to keep cooked food hot and to warm plates and serving dishes. To reheat food from cold, use a cooking function at 150°C, then switch to Warm set between 70-90°C only when the food is piping hot. Note: this function is not for cooking food and the temperature cannot be set higher than 90°C. This function is also ideal for proving bread dough. Set the temperature to 40 °C.

USING THE ROTISSERIE

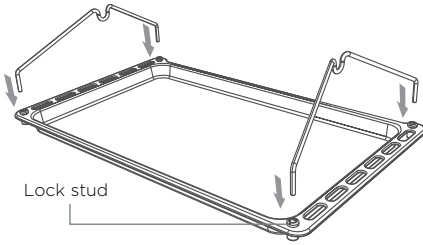

- ① Prepare the rotisserie supports.
 - Place the grill tray on the benchtop.
 - Insert the supports into the lock studs making sure the supports face inwards.
 - Push the supports all the way down to lock them in firmly.

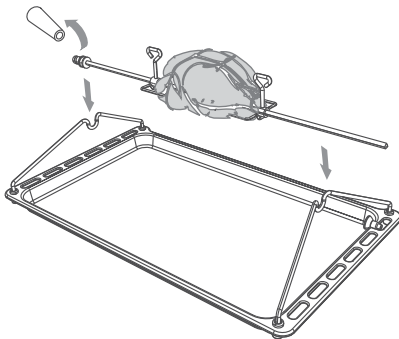

- ③ Position the skewer on the supports.
 - Place the skewer on the supports, and check that the meat does not touch the grill tray.
 - Twist the handle off. It must not be left in the oven.

Rotate the fork screws to loosen and tighten

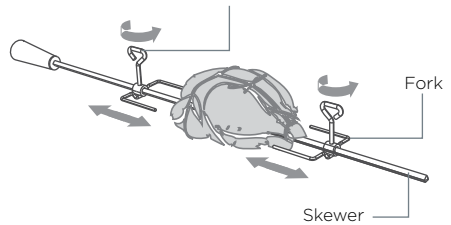

- ② Secure the meat. Slide one fork onto the skewer first, followed by the meat and the the second fork.

IMPORTANT!

Take care, the forks are sharp!

When securing the meat, ensure that:

- the skewer goes through the centre of the meat
- the forks hold the meat firmly in place
- the fork screws are tightened
- there are no loose or projecting parts. Poultry should be trussed.

Note: the rotisserie can rotate up to 6 kg of meat.

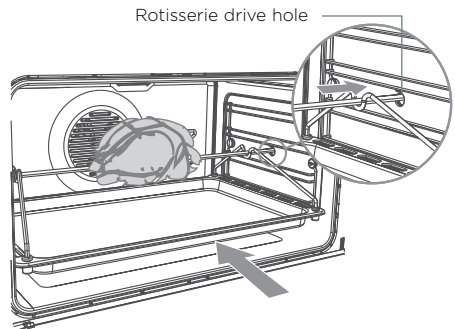

- ④ Place the rotisserie in the oven.
 - Slide the grill tray all the way to the back on shelf position 1.
 - Push the skewer through the hole cover on the right-hand wall of the oven, then insert it fully into the rotisserie drive hole.

USING THE ROTISSERIE



FUNCTION

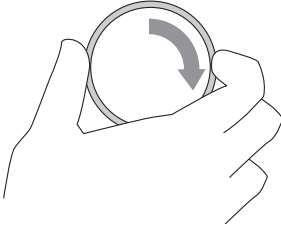

- ⑤ Select the Rotisserie function.
 - The skewer will start rotating.
 - Check that the meat does not touch the grill tray or the grill element at the top of the oven.

210

TEMPERATURE

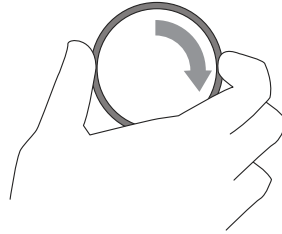

- ⑥ Set the temperature.
 - We recommend around 210 °C.
Note: The rotisserie will not rotate when the oven door is open.

When you have finished using the rotisserie

- ① Turn the oven off.
- ② Using oven mitts, carefully disengage the right end of the skewer from the rotisserie drive hole.
- ③ Slide out the grill tray and place it on a heat-resistant surface.
- ④ Twist the handle onto the left end of the skewer.
- ⑤ Lift the skewer off the supports by the handle.
- ⑥ Loosen the fork screws and slide the meat off the skewer.

Tips for using the rotisserie

- For food safety reasons, we do not recommend using the rotisserie with stuffed meat.
- If your meat is too big or heavy (over 6 kg) for the skewer, place it on top of the grill rack in the grill tray, and use Fan Forced. This function will give a result similar to a rotisserie.
- Use a meat thermometer to ensure that meat is cooked through to a safe temperature.
- See 'Care and cleaning' for advice on cleaning the rotisserie parts.





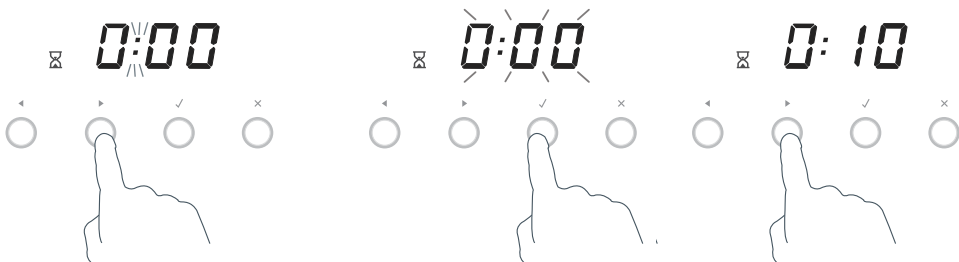

USING THE TIMER

- You can use the timer at any time, even if you are not using the oven.
- If the time is more than an hour, the display will count down in minutes (hr:min). If it is less than an hour, it will count down in seconds (min:sec).
- You can set the timer for up to 23 hours 59 minutes.



IMPORTANT!

The timer does NOT turn the oven off.







- ① Select the timer  by pressing the right scroll  button once.
 - The timer  indicator will appear and the colon will flash.
- ② Press the select  button to confirm.
 - The display will flash to indicate the timer is ready to be set.
- ③ Set the time by pressing the scroll   buttons.
 - Holding the buttons down will speed up the scrolling.



- ④ Press the select  button to confirm.
 - The timer will then begin to count down.
- ⑤ If you want to check the time of day, you can toggle between this and the timer countdown by pressing the scroll   buttons.

To modify the timer setting

- ① Make sure the display shows the remaining time counting down.
- ② Press the select  button.
- ③ Press the scroll   buttons to set a new time.
- ④ Press the select  button to confirm.

To cancel the timer setting

- ① Make sure the display shows the remaining time counting down.
- ② Press the cancel  button until the display shows the time of day and the timer indicator disappears.

When the set time is up

- The display will show  and a tone will sound every 15 seconds.
- Press any button to stop the tone sounding. The display will revert to showing the time of day.

AUTOMATIC COOKING

- You can set the oven to automatically turn on later, cook for a preset time (cooking time), then automatically turn off at a preset stop time. See the example and instructions below (steps 1 to 7).
- If you start cooking manually and only want the oven to turn off automatically after a set cooking time: simply set the cooking time following steps 1 to 3 below. The oven will automatically turn off when the cooking time is over.

IMPORTANT!

Safe food handling: leave food in the oven for as short a time as possible before and after cooking or defrosting. This is to avoid contamination by organisms which may cause food poisoning. Take particular care during warmer weather.

Example: It is 11:05 a.m. You want your food to cook for 1 hour, and you would like it to be ready by lunchtime (12:30 p.m.)

Set the cooking time



- ① Check the clock shows the correct time of day.
- ② Press the right scroll ► button twice to scroll to the cooking time .
- ③ Press the select ✓ button to confirm.
- ④ Press the right scroll ► button to set the cooking time. Make sure you allow for preheat time in your calculation.
- ⑤ Press the select ✓ button to confirm.

Set the stop time



- ⑥ Press the right scroll ► button once to scroll to the stop time .
- ⑦ Press the select ✓ button to confirm.
- ⑧ Press the right scroll ► button to set the time you would like your food to be ready by (ie the stop time).
- ⑨ Press the select ✓ button to confirm.

AUTOMATIC COOKING

Select function and temperature



FUNCTION

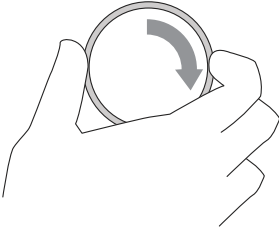

⑩ Select a function.

180

TEMPERATURE

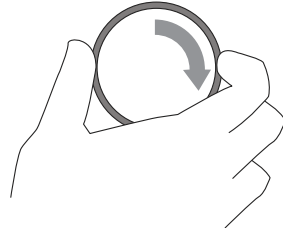

⑪ Set the temperature.

When automatic cooking is set

- The oven and the lights will stay off, the halos will be unlit, but your oven is now set for automatic cooking. It will automatically turn on at the required time.
- In a few seconds, the display will show the time of day with the cooking time ⌚ and stop time ⌚ indicators lit.
- Note: you can modify the function and temperature while the oven is waiting to start cooking.

When the stop time is reached

The oven will automatically turn off and a long tone will sound.

To check the set cooking time and stop time

Use the scroll ◀ ▶ buttons.

To cancel automatic cooking

Turn the function dial to Off.

To change the cooking or stop time

Use the right scroll ▶ button to scroll to the cooking time ⌚ or the stop time ⌚, press to select the one you want to change and use the scroll ◀ ▶ buttons to change the time. Press the select ✓ button to confirm.

To see the current time of day

Press the cancel ✕ button.

COOKING CHART

Please note:

- The settings in the following chart are guidelines only. Follow the instructions in your recipe or on food packaging and be prepared to adjust the oven settings and baking times to achieve the best possible results for you.
- Shelf positions are counted from the base up (1 is the lowest, 4 the highest).
- Arrange oven shelves before you turn the oven on, then preheat the oven to the required temperature. Place items in the oven only when the long tone has sounded and the temperature dial halo has turned from red to white.*
- Single shelf positions below use the flat oven shelf; where a multi shelf arrangement is recommended, the higher position uses the step-down shelf.
- Due to the width of the oven, a single shelf can usually accommodate double the standard recipe.

FOOD	NOTE ON ARRANGEMENT	SHELF POSITION(S)	BEST FUNCTION	TEMP (°C)	TIME
Small cakes	single shelf	2	Bake	180-190	13-17 mins
	multi shelf	1 and 3	Fan Forced	160-170	16-23 mins
Scones	single shelf	2	Fan Forced	210-230	8-12 mins
	multi shelf	1 and 3	Fan Forced	210-230	8-16 mins
Sponge	two small pans (20 cm), on single shelf	2	Bake	170-190	25-35 mins
	one large pan (26 cm)	2	Bake	175	30-40 mins
Light fruit cake	two pans (21 cm) on single shelf	2	Bake	155-165	1 hr 30 mins
Rich fruit cake	exact baking time will depend on size	2	Bake	130-150	3-6 hrs
Apple pie	single shelf	1	Bake	185	35-45 mins
Quiche	single shelf	1	Bake	180-200	30-40 mins
Meringues	single shelf	1	Bake	100-120	1 hr
Bread rolls	single shelf	1	Bake	210-230	15-20 mins
Muffins	2 x 12 muffin trays on single shelf	3	Fan Forced or Fan Bake	190-200	10-15 mins
Pastry case (baked 'blind')	one 21 cm flan tin	1 or 2	Pastry Bake	200	10 mins with beans, then 10 mins without
Roast Chicken	Rotisserie	1	Rotisserie	210	20-30 mins/450gms
Roast Beef (Boneless)	single shelf	1 or 2	Roast	160-170	35-40 mins/450gms
Lasagna	single shelf	2	Fan Bake	175-180	40-50 mins

* Note: the colour change and tone may occur some time after the set temperature has been reached. This is because—when heating up from cold—your oven is designed to initially heat to a temperature somewhat higher than what you have set. This is to provide optimal baking conditions right from the start.

USER PREFERENCE SETTINGS

You can set your oven to:

- display the temperature in degrees Celsius or Fahrenheit
- give audio feedback (tones and beeps) or operate quietly
- display time as 12-hr or 24-hr
- operate with the display off
- have its lights on or off during cooking
- operate in Sabbath setting (see 'Sabbath setting' following).

Note: you cannot change user preference settings when the oven is set for automatic cooking.

How to change preference settings

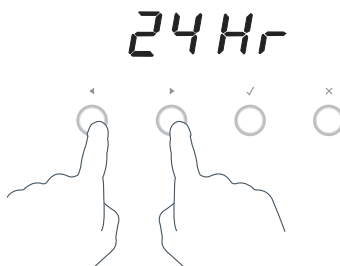

- ① Check the display shows the time of day and the function dial is set to OFF.
 - If you're unsure, press the cancel X button twice.

- ② Press and hold the scroll ◀ ▶ buttons together for 3 seconds to enter the user preference menu.

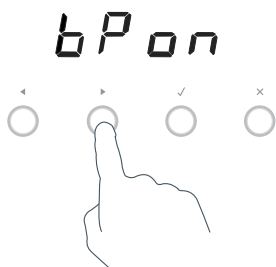

- ③ Press the right scroll ▶ button to scroll to the setting you want to change. Refer to the table following.

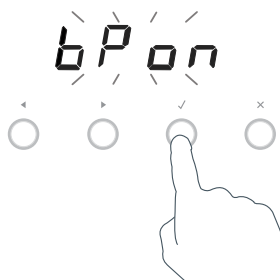

- ④ Press the select ✓ button to select the particular setting.
 - The display will flash.

USER PREFERENCE SETTINGS

bP oF

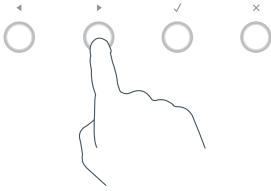

bP on

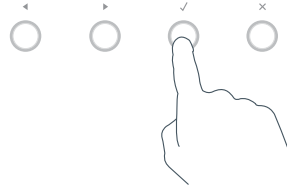

⑤ Press the right scroll ► button to scroll through the options for that particular setting. Refer to the table below.

- ⑥ Press the select ✓ button to save the new option.
 ⑦ For all options except 'Display off' : press the cancel ✕ button to quit the user preference menu.

SETTING	DEFAULT OPTION	ALTERNATIVE OPTION(S)	
TIME SCALE & 'DISPLAY OFF' OPTION Select between 24-hr or 12-hr clock display or set 'Display off' option if you only need the basic functionalities of your oven.	24 HR 24Hr	12 HR 12Hr	DISPLAY OFF ** oFF
TEMPERATURE SCALE Select between degrees Celsius or Fahrenheit.	CELSIUS oC	FAHRENHEIT oF	
AUDIO FEEDBACK Turn the beeps and tones on or off.*	BEEPS/TONES ON bP on	BEEPS/TONES OFF bP oF	
OVEN LIGHTS Have the light off during cooking if you want to save power or want the food you cook to be a surprise for others!	LIGHTS ON DURING COOKING Lt on	LIGHTS OFF DURING COOKING Lt oF	
SABBATH SETTING	SABBATH OFF Sb oF	See 'Sabbath setting' for instructions.	

* The timer tone and alert beeps will sound even if you save the BEEPS/TONES OFF option.

** With this option saved, you can still use the oven and timer but the display will be unlit and the buttons will be unresponsive. To quit this option and enable the display, press and hold the cancel button.

SABBATH SETTING

This setting is designed for religious faiths that observe a 'no work' requirement on the Sabbath.

While your oven is in Sabbath setting

- The display, dial halos and indicators will be unlit, the buttons will be unresponsive.
- No tones or beeps will sound.
- No alert codes or temperature changes will be displayed.
- The oven lights will stay on. If you want the oven lights to be off during Sabbath setting, first select the 'Lights off' option as described in 'User preference settings', and only then set Sabbath setting.
- Bake is the only function available in Sabbath setting.

How to set Sabbath setting

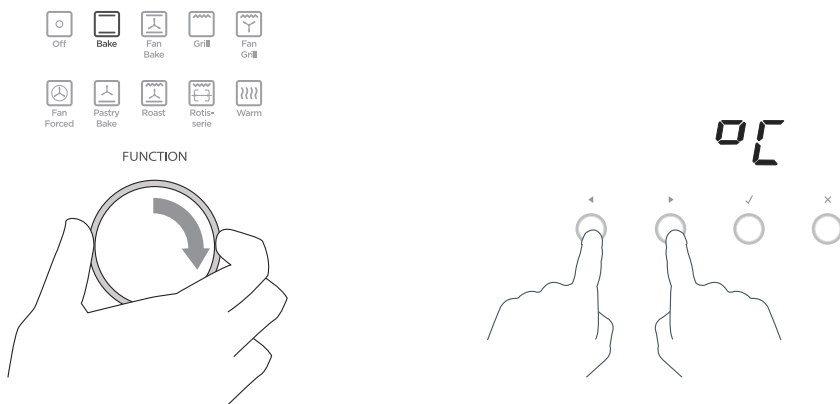

- ① Select the Bake function.
Set the desired temperature.
Wait until the oven starts up.
- ② Press and hold the scroll ◀ ▶ buttons together for 3 seconds to enter the user preference menu.

SABBATH SETTING

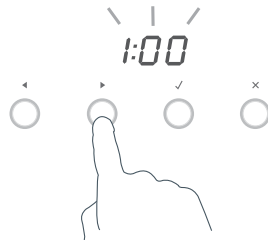
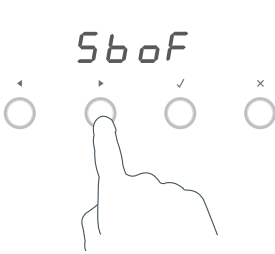

- ③ Press the right scroll ► button to scroll to the Sabbath setting.
- ④ Press the select ✓ button to select the Sabbath setting. The default option is 'Sabbath off'.

- ⑤ Press the select ✓ button to activate the option.
 - The display will flash 1:00.



- ⑥ Press the scroll ◀ ▶ buttons to set the time (hrs). You may set the time up to 99 hours.

- ⑦ Press the select ✓ button to activate the option.

The display, indicators and dial halos will be unlit and unresponsive, but the oven will bake until you quit Sabbath setting.

To quit Sabbath setting

Press and hold the cancel × button until the time of day appears in the display and the oven turns off.

CARE AND CLEANING

DOS

- Before any manual cleaning or maintenance, first wait for the oven to cool down to a safe temperature to touch, then disconnect it from the power supply.
- Read these cleaning instructions and the 'Safety and warnings' section before you start cleaning your oven.
- See the following pages for instructions on removing and refitting different parts of the oven for cleaning.
- To prevent soiling from becoming 'baked on' and stubborn, we recommend removing any spills, food or grease stains from the oven cavity enamel after each use.

DON'TS

- Don't use a steam cleaner.
- Don't keep flammable substances in the oven.
- Don't use or any abrasive or harsh cleaners, cloths, scouring pads or steel wool. Some nylon scourers may also scratch. Check the label.
- Don't leave alkaline (salty spills) or acidic substances (such as lemon juice or vinegar) on the oven surfaces.
- Don't use cleaning products with a chlorine or acidic base.

WHAT?

Glass surfaces

(oven door panes, control panel)

HOW?

- ① Clean these using a soft cloth with a solution of mild detergent or baking soda and hot water, then wipe dry.
- ② Wipe with a glass cleaner and dry with a soft, lint-free cloth.

IMPORTANT!

- **Don't use oven cleaners or any other harsh/abrasive cleaners, cloths, scouring pads, steel wool or sharp metal scrapers to clean the glass surfaces. These scratch the glass and may damage its special coating, which in turn could result in the glass cracking or shattering.**

Dials

Clean with a solution of mild detergent and hot water, then wipe dry.

Do not use stainless steel or oven cleaner, scouring pads, steel wool or abrasive items on the dials as doing so may damage their coating.

Stainless steel strip on the front of the oven door

- Clean with a solution of mild detergent and hot water, then wipe dry with a microfibre cloth.
- If necessary, use a suitable stainless steel cleaner and polish.

- **Always read the label to make sure that your stainless steel cleaner does not contain chlorine compounds as these are corrosive and may damage the appearance of your oven.**
- **Always rub the stainless steel in the direction of the grain.**

CARE AND CLEANING

Manual cleaning

WHAT?	HOW?	IMPORTANT!
Oven cavity	<p>To clean light soiling off the enamelled surfaces:</p> <ol style="list-style-type: none"> ① Wipe with a damp cloth and a solution of hot water and mild detergent. ② Wipe dry with a soft cloth. <ul style="list-style-type: none"> • To clean stubborn, ‘baked on’ soiling: <ol style="list-style-type: none"> ① Remove everything from the oven: shelves, trays, the side racks and catalytic panels. See the pages following for instructions. ② Use an ammonia-based cleaner or an oven cleaner. Follow the cleaner manufacturer’s instructions. 	<ul style="list-style-type: none"> • To prevent soiling from becoming ‘baked on’ and stubborn, we recommend removing any spills, food or grease stains from the enamelled surfaces after each use. • To clean the cavity ceiling, you will need to lower the grill element first. See Fig. 7. • To make cleaning the oven cavity easier, you can remove the oven door too. See pages following for instructions.
Grill tray Grill rack Side racks Oven shelves Rotisserie parts Baking tray	<ul style="list-style-type: none"> • Clean with a solution of mild detergent and hot water. • Pre-soak stubborn burnt-on stains. • Except for the baking tray, these parts are also dishwasher safe. 	<ul style="list-style-type: none"> • You don’t need to remove the four lock studs from the grill tray. They can be soaked and cleaned while fixed to the tray.
Sliding shelf supports	<p>Wipe with a damp cloth and mild detergent. Do not wipe off or wash away the white lubricating grease (visible when the slides are extended).</p>	<p>Do not wash these in the dishwasher, immerse in soapy water, or use oven cleaner on them as doing so will remove the white lubricating grease and prevent the slides from running smoothly.</p>
Oven seal	<p>Do not clean this part.</p>	
Oven vent louvres	<p>Wipe with a damp cloth.</p>	<p>Take care not to let any liquid run down the louvres of the oven vent.</p>

CARE AND CLEANING

WHAT?	HOW?	IMPORTANT!
Side catalytic panels	<ul style="list-style-type: none">• If you roast or grill a lot of meat and hardly ever bake, heating an empty oven for 60-90 mins at 250 °C on Bake from time to time will help the panels to break down any greasy soiling.• To remove large food particles: gently wash the panels in warm soapy water. Rinse in clean water and allow to dry naturally.• If the panels become oversaturated, they will appear shiny and their ability to 'self-clean' will be reduced. In this event, they can be reversed.	<ul style="list-style-type: none">• These panels are normally 'self-cleaning' because their special enamel breaks down greasy splatters when the oven is used for 'non-greasy' baking, especially at high temperatures.• Never use scourers, brushes, abrasives or cleaners with acid or alkali content on the catalytic panels.

CARE AND CLEANING

Drop-down grill element

IMPORTANT!

Turn off the oven at the wall and wait until the element has cooled completely before starting.

- To lower the grill element: use a flat-head screwdriver or a small coin to loosen the element fixing screws.
- When you have finished cleaning the oven ceiling, raise the grill element and screw the element fixing screws back onto the studs. Make sure that the fixing screws are tightened and the element is held securely in place.
- The grill element itself is self-cleaning.

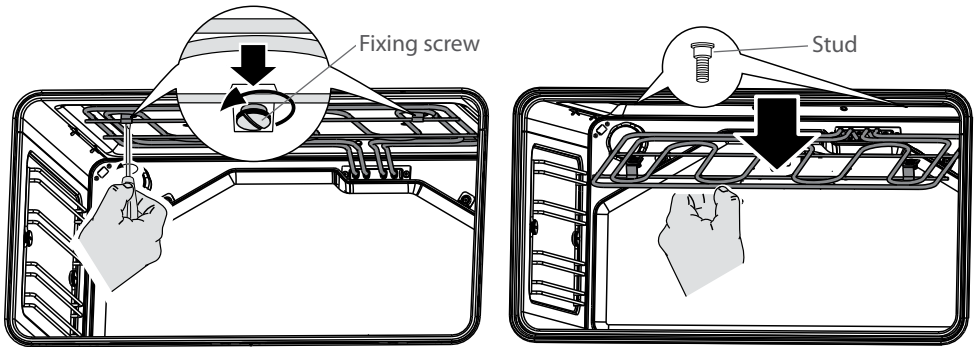

CARE AND CLEANING

Removing and refitting the sliding shelf supports

IMPORTANT!

- Remove the side racks first to make removing the sliding shelf supports easier.
- The sliding shelf supports can only be used on shelf position 1, 3 and 4. They cannot be used on shelf position 2.

When refitting the sliding shelf supports, make sure that you fit:

- the side racks first
- the slides to the top wire of the shelf position
- both sides of each pair of slides
- both slides on the same level.

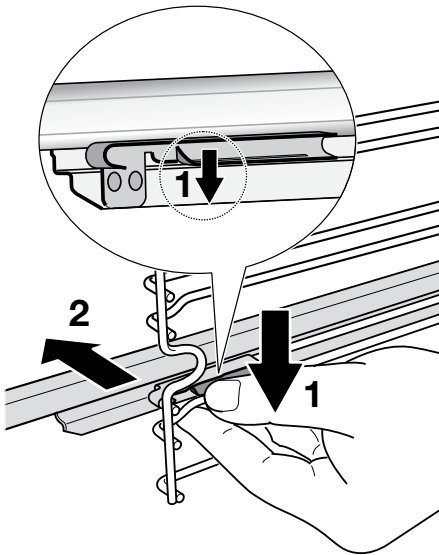

Removing the sliding shelf supports

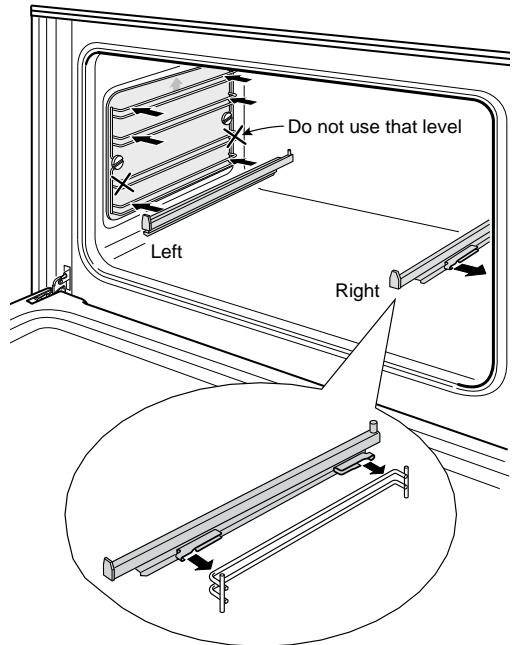

Refitting the sliding shelf supports

CARE AND CLEANING

Removing and refitting the oven door

We recommend removing the door to make cleaning the interior parts of the oven or replacing the light bulb(s) easier.

IMPORTANT!

- **Take care, the oven door is heavy. If you have any doubts, do not attempt to remove the door.**
- **Make sure the oven and all its parts have cooled down. Do not attempt to handle the parts of a hot oven.**

To remove the door

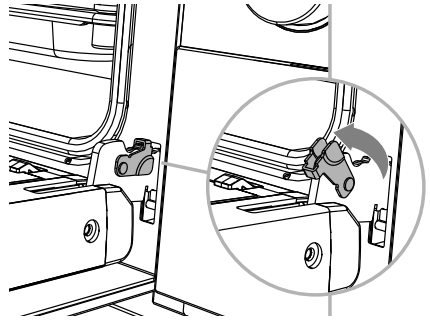
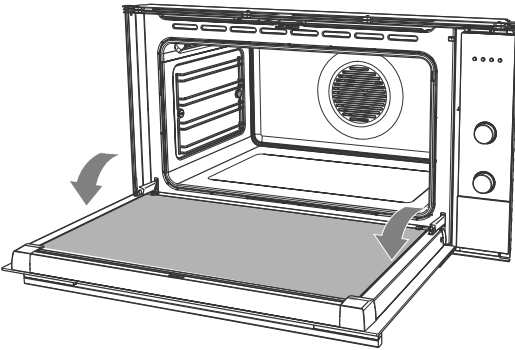

- ① Make sure you have prepared enough space for resting the door and its glass panes on a clean, flat surface.
- ② Open the door to its full extent.
- ③ Open the levers on the left and right hinges to their full extent, as shown.

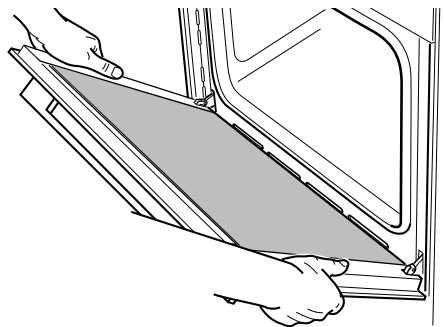
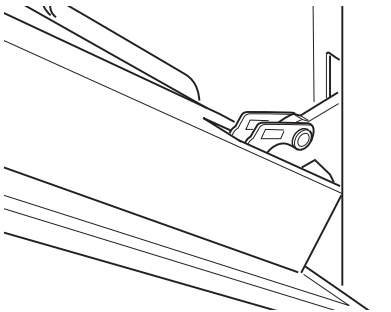

- ④ Gently close the door until the left and right hinge levers are hooked to the door.
- ⑤ Hold the door firmly, as shown.

CARE AND CLEANING

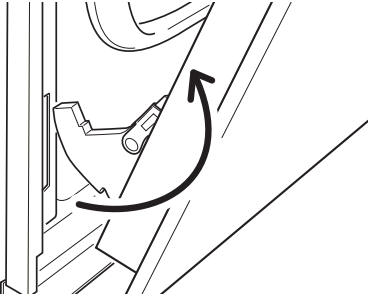

- ⑥ Lift the door and disengage the hinges. Rest the door on a soft surface. Ensure you lay it with the handle side down.

Refit the door

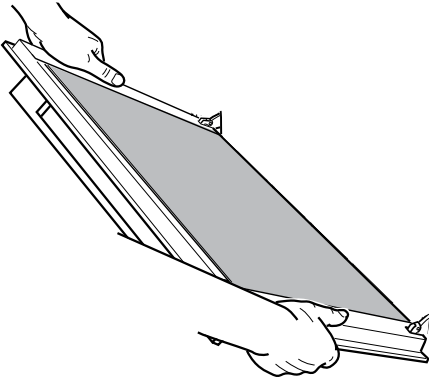

- ① Hold the door firmly.

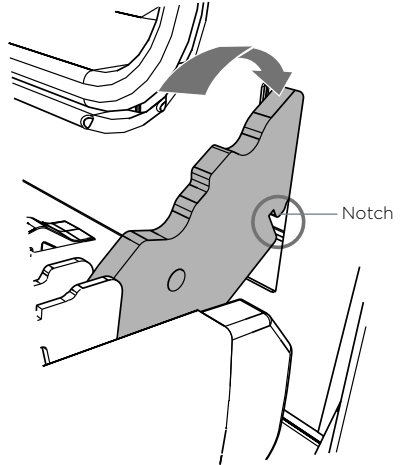

- ② Insert the hinge tongues into the slots, making sure that the notches on both sides drop into place as shown.

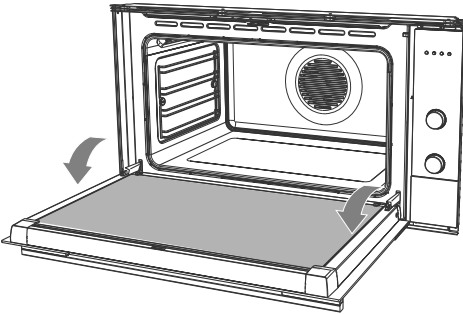

- ③ Open the door to its full extent.

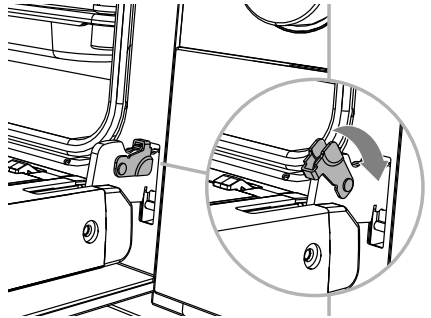

- ④ Fully close the levers on the left and right hinges, as shown.
⑤ Close the door and check that it is properly in place: it should sit square to the oven vent louvres and the control panel.

CARE AND CLEANING

Removing and replacing the inner glass pane

The oven door has two panes of glass. The inner pane can be removed to make cleaning the glass easier.

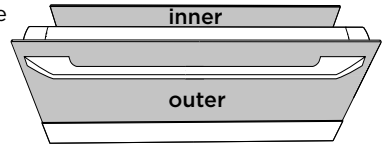

IMPORTANT!

- **Take extreme care when handling the glass pane. Avoid the edges of the glass bumping against any surface. This may result in the glass shattering.**
- **Don't use oven cleaners or any other harsh/abrasive cleaners, cloths, scouring pads, steel wool or sharp metal scrapers to clean the glass surfaces. These scratch the glass which in turn could result in the glass cracking or shattering.**
- **If you notice any sign of damage on any of the glass panes (such as chipping or cracks), do not use the oven. Call your Authorised Repairer or Customer Care.**
- **Make sure you replace the inner glass pane correctly. Do not use the oven without the inner glass pane correctly in place.**
- **If the inner glass pane feels difficult to remove or replace, do not force it. Call your Authorised Repairer or Customer Care for help. Note: service visits providing assistance with using or maintaining the oven are not covered by your warranty.**

To remove the inner glass pane

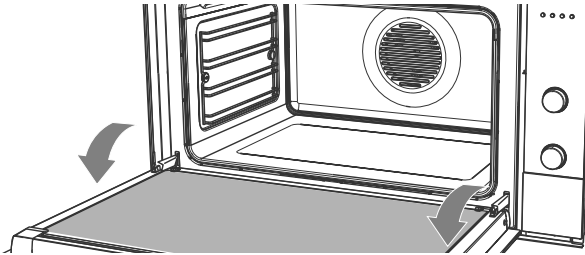

- ① Remove the oven door following the instructions in 'Removing and refitting the oven door'. Lay it on a protected surface with the handle down.

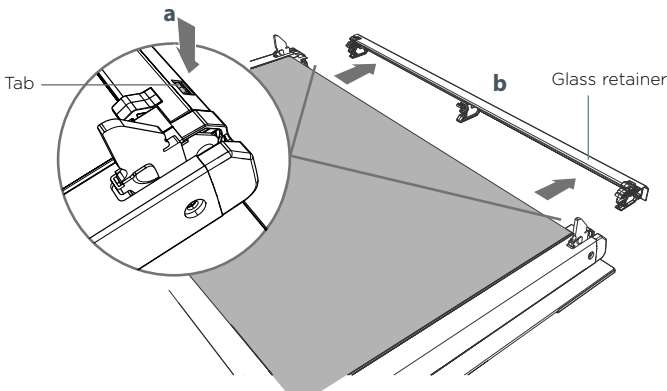

- ② Press down on both tabs (a) to release the glass retainer (b).

CARE AND CLEANING

Replacing the oven light bulbs

The oven light bulbs (12V/20 W halogen) have a very long life, but if you should need to replace one, use only a replacement bulb purchased from your nearest Fisher & Paykel dealer and follow these steps. **Note: oven bulb replacement is not covered by your warranty.**

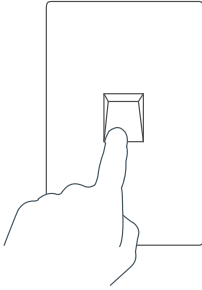

- 1 Allow the oven to cool down, then turn it off at the mains power supply (wall switch).

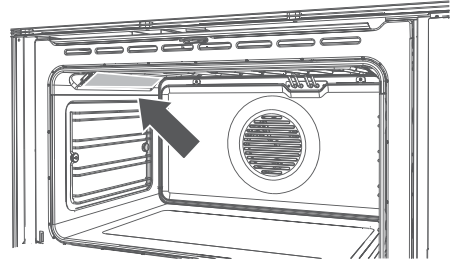

- 2 Remove any oven shelves that may get in the way.

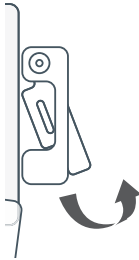

- 3 Using a flat-head screwdriver, twist and lift the retainer clip upwards to release the glass cover. Hold the glass cover to prevent it falling.

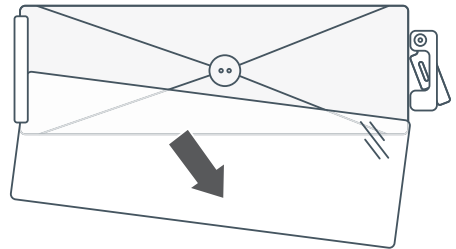

- 4 Carefully lift the glass cover out of the retaining bracket in the back and pull out the faulty bulb.



- 5 Hold the replacement bulb in a soft cloth or tissue (touching the bulb will reduce its life span) and insert it into the socket.

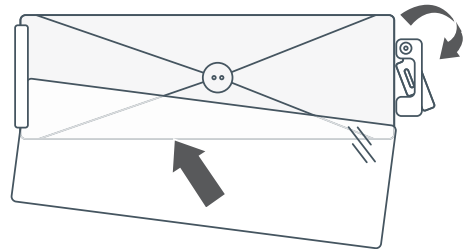

- 6 Reposition the glass cover and twist the retainer clip back in place. Turn the oven back on at the mains power supply (wall switch).

TROUBLESHOOTING

Troubleshooting chart

If there is a problem, check the chart below to see if you can fix it. If the problem cannot be fixed or persists, call your Authorised Repairer or Customer Care.

PROBLEM	POSSIBLE CAUSES	WHAT TO DO
General		
The oven does not work.	No power.	Check that the mains power supply (wall switch) is turned on, the fuse has not tripped and there is no power outage in your area.
The lights do not come on when I open the oven door.	The oven light bulb(s) have blown.	Replace the light bulb(s). See 'Care and cleaning' for instructions.
	The door is not correctly fitted.	See 'Care and cleaning' for instructions on fitting the door correctly.
	The oven is in Sabbath setting and the 'Light off' option has been saved.	To quit Sabbath setting, press and hold the cancel × button. See 'User preference settings' for instructions on changing the 'Light off' option.
The temperature indicator shows --- and the dials and buttons are unresponsive.	The control panel is locked.	Press and hold the select ✓ or cancel × button to unlock the control panel.
The oven is not heating.	The door is not properly closed or it is opened too frequently during cooking.	The heating elements are disabled while the door is open. Make sure the door is properly closed and avoid opening it frequently during cooking.
A glass pane in the oven door has cracked, chipped, or shattered.	Incorrect cleaning or the edge of the glass hitting against something.	You must NOT use the oven. Call your Authorised Repairer or Customer Care.

TROUBLESHOOTING

PROBLEM	POSSIBLE CAUSES	WHAT TO DO
General		
The oven has reached the set temperature but the temperature dial halo is still red (indicating that the oven is not ready to use).	This is normal: when heating up from cold, your oven is designed to initially heat to a temperature somewhat higher than what you have set. This is to provide optimal baking conditions right from the start.	Wait until a long tone sounds and the temperature dial halo turns white: the oven will then be ready to use.
The oven is heating but the display is dark.	The oven is set to 'Display off' option.	To quit the 'Display off' option, press and hold the cancel × button until the display shows the time of day.
	The oven is in Sabbath setting.	To quit Sabbath setting, press and hold the cancel × button until the display shows the time of day.
The oven cancels automatic cooking when I try to adjust the clock setting.	The oven was set for automatic cooking when you were trying to adjust the clock setting.	You can only adjust the clock setting while the oven is not set for automatic cooking. See section 'Setting the clock and first use' for instructions.
The oven beeps when I try to turn the temperature dial OFF or below a certain temperature.	This is normal: for food safety reasons, the oven functions have factory-set minimum temperature settings.	The temperature dial itself cannot be 'turned off'. Selecting Off with the function dial will turn the oven off.
The temperature dial halo never turns white when I use Grill.	This is normal: the halo stays red to indicate that the grill element provides instant radiant heat.	
The rotisserie skewer will not rotate.	The skewer did not fully engage in the rotisserie drive.	Make sure the skewer is pushed fully into the rotisserie drive hole.
	The meat is too heavy.	To get a finish similar to a rotisserie for pieces of meat or poultry heavier than 6 kg, use the grill tray and rack and the Roast function.
The rotisserie skewer stops rotating when I open the door.	This is normal: the rotisserie drive is disabled while the door is open.	

ALERT CODES

If there is a problem, the oven will:

- automatically suspend all oven functions
- beep five times
- display an alert code.

IMPORTANT!

Do not turn off the mains power supply to the oven (wall switch) if you get an alert code, unless the instructions in the chart following specifically instruct you to. There are cooling fans within the oven which are needed to cool the oven's components. Turning off the power while the oven is too hot may damage the oven and its surrounding cabinetry.

What to do if an alert code is displayed

- ① If the beeping hasn't stopped already, press any button to stop it.
- ② Make a note of the alert code displayed. You may need this information.
- ③ Check the chart following to see if you can fix the problem yourself and follow the instructions.
- ④ If you can fix the problem and the alert code does not reappear, you can keep using your oven.

OR

If you can't fix the problem yourself or the alert code reappears and the problem persists: wait until the cooling fans have stopped and the oven has completely cooled down, then turn the power to the oven off at the wall and call your Authorised Repairer or Customer Care with the alert code information.

ALERT CODE	POSSIBLE CAUSES	WHAT TO DO
<i>H</i> 1	The oven has overheated.	<ol style="list-style-type: none">① Allow the oven to cool down.② Once the oven has cooled down and the door has unlocked, the alert code will disappear. You can now use the oven again.
<i>F</i> + number	Technical fault.	<ol style="list-style-type: none">① Note down the alert code.② Wait until the cooling fans have stopped and the oven has completely cooled down.③ Turn the power to the oven off at the wall.④ Call your Authorised Repairer or Customer Care with the alert code information.

WARRANTY AND SERVICE

Before you call for service or assistance ...

Check the things you can do yourself. Refer to the installation instructions and your user guide and check that:

- ① Your product is correctly installed.
- ② You are familiar with its normal operation.

If after checking these points you still need assistance or parts, please refer to the Service & Warranty book for warranty details and your nearest Authorised Service Centre, Customer Care, or contact us through our website www.fisherpaykel.com.

This oven has been designed and constructed in accordance with the following codes and specifications:

In New Zealand and Australia

- AS/NZS 60335-1 General Requirements for Domestic electrical appliances
- AS/NZS 60335-2-6 Particular Requirements for Domestic electrical cooking appliances
- AS/NZS CISPR 14.1 2010 Electromagnetic Compatibility Requirements.

Complete and keep for safe reference:

Model _____
Serial No. _____
Purchase Date _____
Purchaser _____
Dealer _____
Suburb _____
Town _____
Country _____

FISHERPAYKEL.COM

© Fisher & Paykel Appliances 2018. All rights reserved.

The product specifications in this booklet apply to the specific products and models described at the date of issue. Under our policy of continuous product improvement, these specifications may change at any time. You should therefore check with your Dealer to ensure this booklet correctly describes the product currently available.

NZ AU

591670A 07.18