

# Series 9, Contemporary Tall Built-under Dishwasher

Series 9 | Contemporary

Black Glass



Offering a superior wash performance and advanced drying, this tall dishwasher is designed to fit flush under your benchtop.

- Designed to be built under your benchtop, fitting flush with cabinetry for a seamless look
- Eight wash programs from Heavy to Light, including Auto, 60min and Glassware
- Dry+, Sanitise, Half Load and Intensive modifiers provide extra wash options

- Wi-Fi enabled and works with the SmartHQ™ app for remote control and notifications

## DIMENSIONS

Height	857 - 917 mm
Width	597 mm
Depth	574 mm

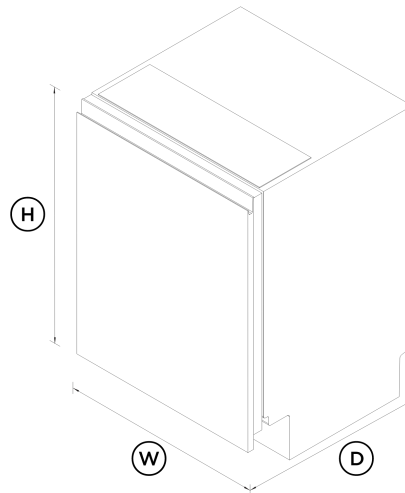

## FEATURES & BENEFITS

### Considered Design

Designed to match our Contemporary style family of products in black glass, this built-under dishwasher has a beautiful matte-black glass finish. Fitting flush with cabinetry, the recessed handle design provides a seamless finish in your kitchen.

### SEAMLESS INTEGRATION

Our built-under dishwashers are installed flush under your benchtop with the option of a custom kickstrip, ensuring minimal gaps.

### Advanced Drying

For beautifully dry dishes every time, this dishwasher features an advanced drying system. It combines fan-assisted drying with an automatic door opening at the cycle's end. The Auto Door Open Dry feature releases excess steam, ensuring dishes are immediately ready for use or storage. An innovative air curtain channels the steam away from the adjacent benchtop, protecting your cabinetry.

### An Exceptional Clean

This dishwasher offers eight wash programs including Glassware and Auto, which automatically senses the optimal wash settings for your dishes. The three-stage filtration system delivers a superior clean, while the rinse aid indicator reminds you to top up for beautifully clean dishes.

### Customise Your Wash

Create the perfect wash with our range of modifiers, from Intensive for a thorough clean to Half Load, ideal for a partial load. The Sanitise modifier provides extra protection, killing 99.9% of bacteria\* in the final rinse, while Dry+ is great for plastic dishes. \*Certified to NSF/ANSI Standard 184

### Quiet Performer

Running at a very low decibel rating, this dishwasher does its job without making a fuss. The combination of clever technology and simple mechanics means greater reliability and superior wash performance, with minimal noise.

### Efficient Performance

With a 4.5 star energy rating and 5.5 star water rating, this dishwasher delivers a powerful wash. Use the Eco wash program for optimal water and energy consumption, or choose when the cycle begins with Delay Start.

**SPECIFICATIONS**

**Accessories (included)**

Cutlery basket	•
Kickstrip	<b>true</b>

**Capacity and loading**

Accommodates round plates up to (lower basket)	<b>325mm</b>
Accommodates round plates up to (top basket)	<b>220mm (with cutlery tray), 280mm (cutlery tray removed)</b>
Adjustable height, foldable cupracks	•
Easy lift adjustable upper basket	•
Fold down tines	•
Fold down wine racks	•
Full width cutlery/utensil tray	•
Large crockery insert in lower basket	•
Place settings	<b>15</b>
Place settings	<b>15</b>
Telescopic slides	•
Wine glass supports	•

**Consumption**

Energy rating	<b>4.5 star</b>
Energy usage	<b>206kWh/year</b>
In-use energy carbon emissions estimate	<b>27.9kgCO2e/year</b>
Water consumption (per wash cycle)	<b>11.1L</b>
Water rating	<b>5.5 star (WELS)</b>

**Controls**

Energy saving delay start option of up to 12 hours	•
Floor light cycle feedback	•
Internal light	•
Intuitive capacitive touch controls	•
Keylock	•
Rinse aid indicator light	•
Smart appliance	•

**Features**

Air curtain for bench protection	•
Aquastop	•
Auto Door Open Dry	•
Fan assisted drying	•
Flood protection	•
Fully independent spray arms	•
Half load option	•
Motor type	<b>BLDC</b>
Three-stage filtration system	•
Variable wash pressure technology	•

**Performance**

Noise emissions	<b>42 dBA</b>
-----------------	---------------

**Power requirements**

Amperage	<b>10A</b>
Supply frequency	<b>50Hz</b>

Supply voltage	<b>220 - 240V</b>
----------------	-------------------

**Product dimensions**

Depth	<b>574 mm</b>
Height	<b>857 - 917 mm</b>
Width	<b>597 mm</b>

**Warranty**

Parts and labour	<b>2 years</b>
------------------	----------------

**Wash Program Modifiers**

Dry +	•
Half load	•
Intensive	•
Sanitise	•
Wash modifiers	<b>4</b>

**Wash Programs**

60 min	•
Auto	•
Eco	•
Glassware	•
Heavy	•
Light	•
Medium	•
Rinse	•
Wash programs	<b>8</b>

**Water connection**

Water pressure	<b>30kPa - 1000 kPa</b>
Water supply	<b>3/4" BSP (20mm) Connector Water Inlet Hose</b>

---

SKU 82439

---

The product dimensions and specifications in this page apply to the specific product and model. Under our policy of continuous improvement, these dimensions and specifications may change at any time. You should therefore check with Fisher & Paykel's Customer Care Centre to ensure this page correctly describes the model currently available. © Fisher & Paykel Appliances Ltd 2020

**Other product downloads available at fisherpaykel.com**

- [↓ Datasheet](#)
- [↓ Energy & Water Label](#)
- [↓ Service & Warranty](#)
- [↓ Installation Guide](#)
- [↓ User Guide](#)
- [↓ Wash Program Data Dishwasher](#)

**Where applicable:**

All appliances use energy, and energy usage typically generates carbon emissions. **Fisher & Paykel Appliances' In-use Energy Carbon Emissions Estimate** indicates carbon emissions from a product's in-use energy. This is calculated either annually or per cycle, using the product's market-specific energy label energy consumption data multiplied by the carbon emissions factor for energy in your country or region.

Our In-use Energy Carbon Emissions Estimate is designed to assist customers in making informed purchasing decisions when comparing different Fisher & Paykel products. For example, a heat pump dryer typically has a lower In-use Energy Carbon Emissions Estimate than a vented dryer.



**A PEACE OF MIND SALE**  
**24 Hours 7 Days a Week Customer Support**  
T 0800 372 273 Wwww.fisherpaykel.com