

FISHER & PAYKEL

WARMING DRAWER

MINIMAL

WB24SMB1-SET

CONTEMPORARY

WB24SDB1-SET, WB30SDB1-SET & WB30SDX1-SET

USER GUIDE

US CA

CONTENTS

Safety and warnings	4
Before you begin	8
Using your Warming Drawer	10
Functions	11
Delayed Start	13
Loading your appliance	14
Using the wire shelf	16
Cooking charts	17
Care and troubleshooting	19
Manufacturer's Warranty and Service guide	20
Customer care	21

Registration

To register your product visit our website: fisherpaykel.com/register

⚠ WARNING!



Electric Shock Hazard

Failure to follow this advice may result in electric shock or death.

- If the product is damaged, switch the appliance off and disconnect it from the power supply to avoid possible electric shock.

⚠ WARNING!



Hot Surface Hazard

Failure to follow this advice could result in burns and scalds.

- To avoid burns and scalds, keep children away from this appliance.
- Surfaces of the appliance may become hot enough to cause burns.
- Do not touch heating elements or interior surfaces of the appliance. Heating elements may be hot, even when they are dark in colour.
- Use protective gloves when handling hot surfaces.
- During and after use, do not touch or let clothing or other flammable materials contact heating elements or interior surfaces of the appliance until they have cooled.

SAFETY AND WARNINGS

⚠ WARNING!



Fire Hazard

Failure to follow this advice may result in overheating, burning, and injury.

- Flammable materials should not be stored in the appliance or near its surface.

⚠ WARNING!



Cut Hazard

Failure to use caution could result in injury.

- Take care: some edges may be sharp.
- Do not put fingers in the drawer when closing.

⚠ WARNING!



Tipping Hazard

This product may tip. Keep children away and take care. Failure to follow this advice may result in injury.

- The drawer must be secured in place by supplied screws.
- Ensure there is a fixed shelf directly above the drawer if it is not installed under another product.

READ AND SAVE THIS GUIDE

WARNING!

To reduce the risk of fire, electrical shock, injury to persons or damage when using the appliance, follow the important safety instructions listed below. Read all the instructions before using the appliance. Use the appliance only for its intended purpose as described in these instructions.

General Use

- This appliance has been designed for use in a normal domestic (residential) environment.
- Do not use the appliance outdoors.
- Children should be supervised to ensure that they do not play with the appliance.
- This appliance can be used by children aged from 8 years and above and persons with reduced physical, sensory or mental capabilities or lack of experience and knowledge if they have been given supervision or instruction concerning use of the appliance in a safe way and understand the hazards involved.
- To avoid hazard due to instability of the appliance, it must be fixed in accordance with installation instructions.
- Keep the operating panel clean and dry. Wash and dry your hands before operating the drawer to ensure the buttons will respond properly.
- Avoid drying food types with high moisture content e.g. tomatoes or pineapple.

Installation

- Ensure your appliance is properly installed and earthed by a qualified technician.
- Ensure this appliance is connected to a circuit which incorporates an isolating switch providing full disconnection from the power supply.
- Do not install or operate the appliance if it is damaged or not working properly. If you receive a damaged product, contact your local dealer or installer immediately.
- Do not install the appliance near a hot gas or electric burner or in a heated oven.

Servicing

- Check the appliance for any damage inside or outside surface of the appliance. Do not use damaged cord or plug. If there is any damage, do not operate the appliance. Contact a Fisher & Paykel trained and supported service technician.
- Do not repair or replace any part of the appliance unless specifically recommended in this user guide. All other servicing must be done by a qualified person or Fisher and Paykel trained and supported service technician.

Cleaning and maintenance

- Ensure the appliance is turned off or set in STANDBY mode before cleaning the drawer.
- Unplug from the power outlet and allow the appliance to cool down after use before cleaning the drawer.
- Cleaning and user maintenance shall not be undertaken by children without supervision.
- Use a moderately damp cloth for cleaning. Do not spray water outside or inside the appliance. Water can cause damage inside the appliance.
- Do not use aggressive or abrasive detergent or sharp metal scrapers for cleaning the glass base of the appliance.

SAFETY AND WARNINGS

Safety

- Do not touch hot surfaces. Use handles or knobs.
- Do not sit or lean on the appliance. Damage to the surface of the glass may cause it to shatter.
- Do not store hazardous objects that can explode like containers with gas or air chambers (e.g spray cans).
- Do not immerse cord, plug or other parts in water or other liquid to protect against electrical shock. Do not let the cord hang over the edge of table or counter, or in a heated oven.
- Do not use accessory attachments that are not recommended.

Packaging disposal

- Remove packaging and recycle materials that can be reused.
- Dispose packaging materials in accordance with local regulations on waste disposal.

WARNING!

This product contains a chemical known to the State of California to cause cancer, birth defects or other reproductive harm.

For more information on these regulations and a list of chemicals, visit:<https://oehha.ca.gov/proposition-65/general-info/proposition-65-plain-language>.

BEFORE YOU BEGIN

- Ensure the installer has completed the final checklist in the installation instructions.
- Read this guide, taking special note of the Safety and warnings section.

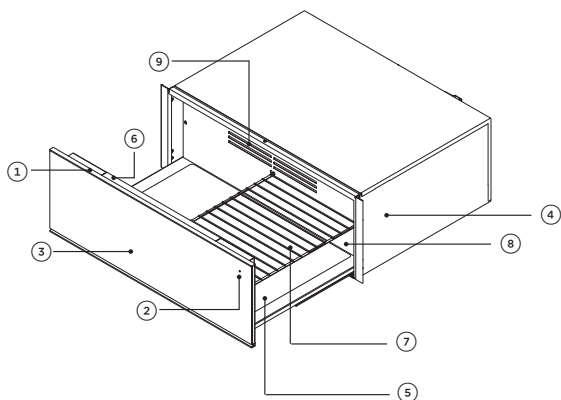

Drawer features & accessories

- ① Control panel
- ② Indicator light
- ③ Push-to-open door*
- ④ Serial plate**
- ⑤ Heated glass base
- ⑥ LED internal lighting
- ⑦ Wire shelf***
- ⑧ Fan Plate
- ⑨ Ventilation slots
- ⑩ Handle**** (not shown)

*Minimal and Contemporary style models only

**Located inside the chassis of the drawer

***30" models only

****Professional style models only

BEFORE YOU BEGIN

Control panel

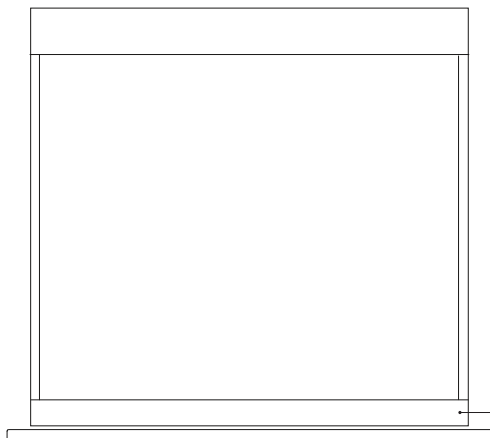
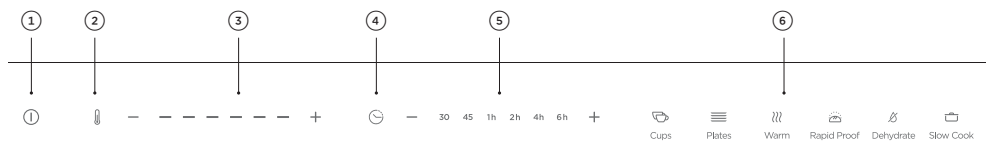

Control panel features

- ① Power On/Off
- ② Temperature indicator
- ③ Temperature controls
- ④ Duration indicator
- ⑤ Duration controls
- ⑥ Heat modes

Using the touch controls

Your Warming Drawer is operated using a touch control panel. To operate the control panel, use the ball of your finger, not its tip. The controls respond to touch, so pressure is not needed.

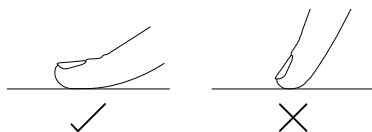

Keep the operating panel clean and dry. Wash and dry your hands before operating the drawer to ensure the buttons will respond properly.

USING YOUR WARMING DRAWER

First time use

If using the Warming Drawer for the first time, three LEDs in temperature controls are illuminated at start up.

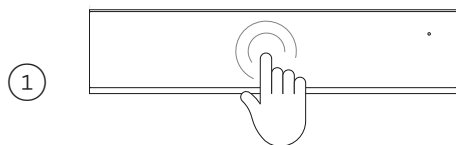

For push-to-open models, touch the centre-front of the drawer to open. Do not force the drawer open.



Touch the ① button to switch the drawer ON.



Select the desired heating function. If no function is selected, the drawer will start at default setting.

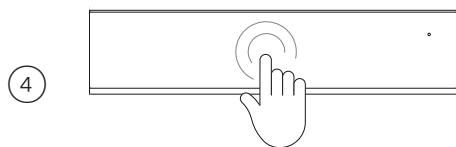

Press the centre of the door to close the drawer. The indicator light will flash if the drawer is not closed.

At the end of a cycle:

A tone will sound and the ① symbol will dim. Use caution when unloading the drawer, the heated glass base and its contents will be hot.

During a cycle

The drawer can be opened at any point during operation. This will pause the programme and the indicator light will flash until the drawer is closed again. To cancel a cycle, touch ① at any time. To turn off the drawer, touch ① for two to three seconds and release.

Standby mode

After 12 hours of continuous use, the drawer automatically switches to standby mode. The ① button is dimmed when in standby mode. Touch ① button to resume drawer use. Do not leave the Warming Drawer unattended for long periods of continuous operation.

FUNCTIONS

Your Warming Drawer is designed to utilise the heated glass base and rear fan in differing heat levels and durations to provide optimal performance. Each function has a default time and temperature setting that illuminates upon selection. These settings can be customised by manually adjusting the duration and temperature controls in place of a pre-set function.

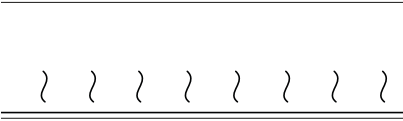

CUPS

Heat circulates from the heated glass base

- Heat is circulated for 30 minutes.
- Heating duration depends on material and thickness of the cups including quantity, height and arrangement.
- Do not place any cups and/or glasses in front of the ventilation slots. This will block the airflow and cause uneven heating.

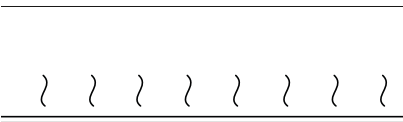

PLATES

Heat circulates from the heated glass base

- Heat is circulated for 45 minutes.
- Heating duration depends on material and thickness of the plates including quantity, height and arrangement.
- Do not place any large plates in front of the ventilation slots. This will block the airflow and cause uneven heating.

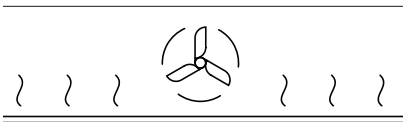

WARM

Heat circulates from the heated glass base and rear fan

- Preheat the drawer for at least 15 minutes before use.
- Heat is produced for 60 minutes.
- Provides constant low heat to keep cooked food hot.
- Do not overfill the drawer to avoid spillage. Cover the food with a heat-resistant lid or aluminum foil to prevent food from drying out.
- This function is not suitable for reheating refrigerated food.

FUNCTIONS

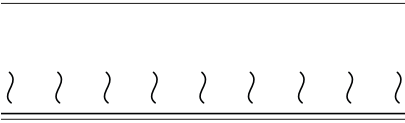

RAPID PROOF

Gentle heat is generated from heated glass base

- Heat is produced for 30 minutes.
- Provides a warm and draft-free environment for proofing dough for bread making or pizza.

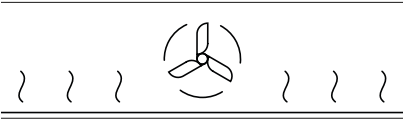

DEHYDRATE

Heat circulates from the heated glass base and rear fan

- Heat is circulated for four hours.
- Provides constant low heat for dehydrating and drying food eg meat, fruit, vegetables and herbs.
- Ideal for preserving food and creating healthy snacks, such as beef jerky, and fruit leather.
- For best results, lay the food flat on a wire shelf and do not overlap.
- If dehydrating meat, turn over halfway through the cooktime to ensure even drying.
- Store dehydrated food in an airtight container after it's completely cooled.

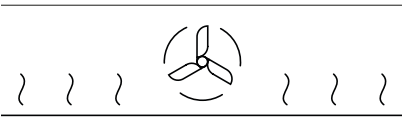

SLOW COOK

Heat circulates from the heated glass base and rear fan

- Heat is circulated for six hours until food is cooked accordingly.
- Ideal for finishing off seared meat at low temperature eg roast meats, casseroles, stews and braises.
- Resting the meat before serving is not necessary since this function uses low temperature. Meat can be carved and served straight from the drawer.

DELAYED START

When using Delayed Start, the Warming Drawer will automatically switch on at a set time and turn off at the end of a cycle.

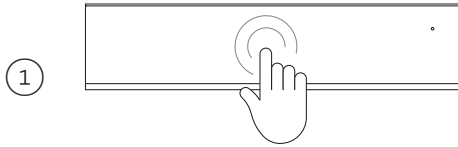

For push-to-open models, press the centre-front of the drawer to open.

Do not force the drawer open.



Touch the ① button and select the desired function.

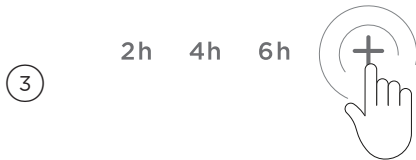

Touch and hold the + button for five seconds to activate **DELAYED START**.



Use + and – to increase or decrease the desired **DELAYED START** time.

Push the drawer closed to start the countdown

During delayed start:

The indicator light will flash until the selected cycle starts. The indicator light will illuminate consistently once the cycle begins

LOADING YOUR APPLIANCE

For WB24SMB1-SET & WB24SDB1-SET models

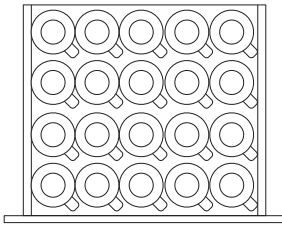

20 Cappuccino cups

Diameter guide
20x Ø3 5/8" (92 mm)

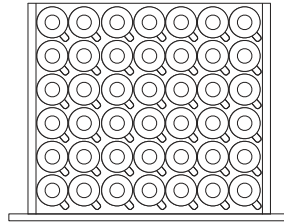

42 Espresso cups

Diameter guide
48x Ø2 1/4" (58mm)

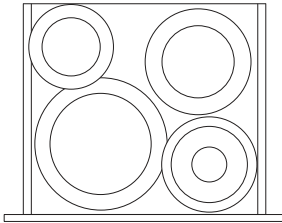
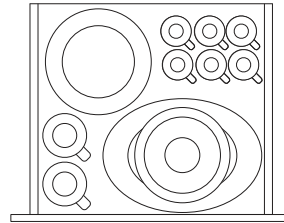

Plate settings

Diameter guide
6x Ø9 13/16" (250mm) Dinner
6x Ø9 1/16" (230mm) Soup bowl
6x Ø7 1/16" (180mm) Bread & Butter
6x Ø6 1/2" (165mm) Saucer



Mixed load

LOADING YOUR APPLIANCE

For WB30SDB1-SET & WB30SDX1-SET models

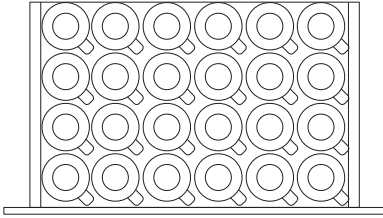

24 Cappuccino cups

Diameter guide
20x Ø3 5/8" (92 mm)

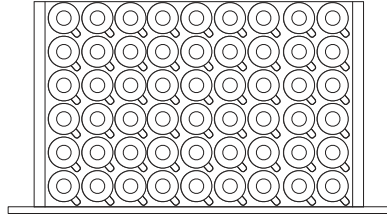

54 Espresso cups

Diameter guide
48x Ø2 1/4" (58mm)

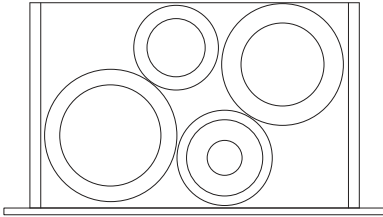
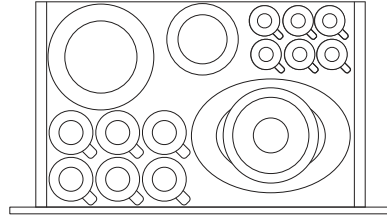

Plate settings

Diameter guide
16x Ø9 13/16" (250mm) Dinner
16x Ø9 1/16" (230mm) Soup
16x Ø7 1/16" (180mm) Bread & Butter
16x Ø6 1/2" (165mm) Saucer



Mixed load

Maximum load

Do not load more than 55lbs (25kg) to prevent damage to the appliance.

Unloading the dishes

Keep dishes in the Warming Drawer until you need to take them out as heated dishes cool down quickly. Always use protective gloves or oven cloths to remove the dishes.

USING THE WIRE SHELF

The wire shelf is available for tall models to increase the loading surface.

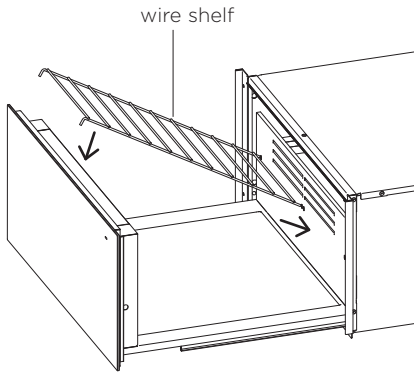

Insert the wire shelf in the left or right hand side of the Warming Drawer.

COOKING CHARTS

The information in these charts is for guidance only. Refer to your recipe or the packaging and be prepared to adjust the cooking times and settings accordingly.

FOOD TYPE	FUNCTION	oz/lb	g/kg	SEAR TIME (mins/side)	INTERNAL TEMP (°F)	INTERNAL TEMP (°C)	TIME
MEAT, BEEF STEAK							
Rare	Slow Cook	3.5 - 10.5oz	100-300g	1-2	120	50	30-60 mins
Medium rare	Slow Cook	3.5 - 10.5oz	100-300g	2-3	130	55	30-60 mins
Medium	Slow Cook	3.5 - 10.5oz	100-300g	3	140	60	30-60 mins
Medium well	Slow Cook	3.5 - 10.5oz	100-300g	3-4	150	65	30-60 mins
Well done	Slow Cook	3.5 - 10.5oz	100-300g	4-5	160	70	30-60 mins
BEEF FILLET							
Medium	Slow Cook	2-4lb	1-2kg	5-8	130	55	4-6 hrs
LAMB SHOULDER							
Medium	Slow Cook	2-4lb	1-3kg	5-8	130	55	4-6 hrs
BONED HAM/ GAMMON							
	Slow Cook	2-4lb	1-3kg	5-8	150	65	4-6 hrs
PULLED PORK							
	Slow Cook	2-4lb	1-3kg	8-10	150	65	4-6 hrs

COOKING CHARTS

FOOD TYPE	FUNCTION	TIME
FRUIT		
Apple, Pear, Banana, Peach, Pineapple, Apricots	Dehydrate	4-8 hrs
VEGETABLES		
Ginger	Dehydrate	4-6 hrs
Carrots, Peas, Beans, Mushrooms, Tomatoes	Dehydrate	4-6 hrs
HERBS		
Rosemary, Dill, Thyme, Bay leaves, Oregano	Dehydrate	2-4 hrs
BREAD DOUGH	Rapid Proof	30 mins
PIZZA DOUGH	Rapid Proof	30 mins

OTHER USES	FUNCTION	TEMPERATURE SETTING	DURATION	RECOMMENDED COOKWARE	TIPS
YOGHURT	Rapid Proof	Low (1)	5-8 hrs	Glass Jars/Ramekins	Covered
MELTING CHOCOLATE	Cups	Low (2)	30 mins	Heatproof Cookware	Uncovered
DISSOLVING GELATINE	Rapid Proof	Low (1)	30 mins	Heatproof Cookware	Uncovered
BATCH COOKING					
Toast, Pancakes, Tortillas	Warm	Medium (3)	1 hr	Heatproof Cookware	Covered



WELLNESS	FUNCTION	TEMPERATURE SETTING	DURATION	RECOMMENDATIONS	TIPS
HEATING WHEAT BAG	Slow Cook	Max (6)	45-60 mins	Place directly on Glass	Slow heating reduces risk of wheat deterioration or burning
HEATING TOWELS	Plates	Medium (3)	45-60 mins	Place directly on Glass	Moisten and roll

CARE AND TROUBLESHOOTING

Cleaning the drawer exterior and interior

- Ensure that the appliance is turned off or set in **STANDBY MODE** before cleaning. Do not use high pressure or steam cleaners.
- Remove any soiling or excess cleaning solution immediately.
- Clean the surfaces with a soft cloth dampened with water and detergent.
- Rub in the direction of the polish lines and dry immediately with a soft cloth.

Troubleshooting

PROBLEM	POSSIBLE CAUSES	SOLUTION
Dishes and/or food remain cold.	The appliance is not switched on	Check the power supply
	The drawer has not been closed	Check that the indicator light is not flashing, if the lamp is flashing ensure the drawer is closed.
Dishes and/or food are not warm enough.	Warming duration too short.	Lengthen the warming duration.
	The drawer is not closed properly.	Close the drawer.
	Temperature is too low.	Select a higher temperature setting.
Internal LED lighting does not illuminate.	Product is in limited feedback mode.	Press and hold  for 10 seconds.
The indicator light flashes regularly and the drawer is closed.	DELAYED START has been set	If not required, cancel function.
	DELAYED START has been set	If not required, cancel function.
The indicator light flashes rapidly and the drawer is open/closed.	Warming Drawer was not switched off.	Touch  button.
	Indicator light is defective.	Call Customer Services.
The drawer cannot be opened or closed.	Push-pull mechanism is damaged	Contact customer support
Internal LED lighting does not illuminate	Drawer is not switched ON. LED is defective.	Contact customer support

MANUFACTURER'S WARRANTY AND SERVICE GUIDE

US



To access your Warranty and Service Guide

Scan the QR code with your smartphone to access your warranty and book a service, refer to your separate warranty and service book or view online at <https://www.fisherpaykel.com/us/help-and-support/warranty-information>

CA



To access your Warranty and Service Guide

Scan the QR code with your smartphone to access your warranty and book a service, refer to your separate warranty and service book or view online at <https://www.fisherpaykel.com/ca/help-and-support/warranty-information>

This product has been designed for use in a domestic (residential) environment. This product is not designed for any commercial use. Any commercial use by the customer will affect this product's Manufacturer's Warranty.

Complete and keep for safe reference:

Model _____

Serial No. _____

Purchase Date _____

Purchaser _____

Dealer _____

City _____

State _____

Zip _____

Country _____

FISHERPAYKEL.COM

© Fisher & Paykel Appliances 2023. All rights reserved.

The models shown in this guide may not be available in all markets
and are subject to change at any time.

The product specifications in this guide apply to the specific products and
models described at the date of issue. Under our policy of continuous product
improvement, these specifications may change at any time.

For current details about model and specification availability in your country,
please go to our website or contact your local Fisher & Paykel dealer.

431027A 12.23