

**FISHER & PAYKEL**

**HEAT PUMP CLOTHES DRYER**

---

DH9060P2 & DH9060PG2 models

**USER GUIDE**

**NZ AU**



## CONTENTS

---

Safety and warnings	5
Control panel	9
Wi-Fi connection & remote mode	12
Dry cycles	14
Dry preparation	15
Getting started quickly	18
Drying cycle options	20
Customising a dry cycle	22
Caring for your dryer	24
Before you call for service	31
Fault codes	33
Troubleshooting	34
Manufacturer's warranty	40
Customer care	42

---

### Registration

To register your product visit our website: [fisherpaykel.com/register](https://fisherpaykel.com/register)



**⚠ WARNING!**



**Electric Shock Hazard**

**Failure to follow this advice may result in electric shock or death.**

- If you are using an extension cord or a portable electrical outlet device (eg multi-socket outlet box), ensure that it is positioned so that it does not come into contact with water or moisture.

**⚠ WARNING!**



**Fire Hazard**

- Only dry fabrics that have been washed with water.
- Do not use heat to dry articles containing foam rubber or similarly textured rubber-like materials, dry on 'Time Dry'.
- Never stop a tumble clothes dryer before the end of the drying cycle unless all items are removed and spread out in order to dissipate the heat.
- A clothes dryer produces combustible lint; the lint filter must be cleaned before each drying cycle.
- Failure to follow the warnings outlined in these user instructions can cause a fire hazard.
- Failure to follow these instructions can result in death or personal injury.

## SAFETY AND WARNINGS

---

### READ AND SAVE THIS GUIDE

When using this appliance, follow basic precautions, including the following:

#### General

- The appliance must not be supplied through an external switching device, such as a timer, or connected to a circuit that is regularly switched on and off by a utility.
- We do not recommend the use of extension cords or portable electrical outlet devices for safety reasons.
- Do not touch or operate the machine with wet hands or with bare-feet.
- A damaged power cord must be replaced by a Fisher & Paykel trained and supported service technician, its service agent or similarly qualified persons in order to avoid a hazard. The appliance must not be operated until it is repaired, as there is risk of electric shock.
- Do not operate this machine if it has been damaged during transport. Contact your Fisher & Paykel dealer or Fisher & Paykel trained and supported service technician.
- This dryer has been designed for domestic use only, not for commercial applications, such as massage/beauty clinics where there may be increased lint accumulation or flammable materials in the atmosphere or load.
- The tumble dryer is intended only for drying textile material washed in water.
- Undergarments that contain metal reinforcements should not be placed in the dryer. Damage to the dryer can result if the metal reinforcements come loose during drying. If you wish to dry these items use a drying rack or place in a garment bag.
- Check and remove all objects from pockets, eg lighters and matches.
- Never dry rubber articles, or any plastic items or film, eg plastic lined tablecloths and baby bibs.
- Clothes should go through the cool down/airing phase in the final part of the cycle. This ensures items are left at a temperature where they will not be damaged. If for any reason the dryer is stopped before the cycle has finished, dry clothes should be removed immediately and not left in the dryer. Clothes should be quickly spread out flat so heat can dissipate, not left bunched up, eg in a clothes basket.
- Do not operate this product without the lint filter in place or allow lint to accumulate in or around the dryer.
- This dryer is not intended for use by persons (including children) with reduced physical, sensory or mental capabilities, or lack of experience and knowledge, unless given supervision or instruction concerning the use of the dryer by a person responsible for their safety.
- Children should be supervised to ensure they do not play with the dryer.
- Unplug the machine from the power supply when it is not in use.
- Do not swing on or put weight on the door.
- In the event of a power outage your dryer will resume automatically when power is restored.
- Never attempt to repair the dryer yourself.
- Do not install the dryer behind a lockable door, sliding door, or behind a door where the hinge is on the opposite side to that of the dryer in such a way that the full opening of the door is inhibited. Ensure the dryer door can always be opened fully.
- The only user-removable parts of the dryer are the filters and drying rack. No other parts are designed to be removed by anyone other than a Fisher & Paykel trained and supported service technician.
- For problems that cannot be solved from information in this user guide, turn off and unplug your dryer and contact a Fisher & Paykel trained and supported service technician.

## SAFETY AND WARNINGS

- Exhaust air must not be discharged into a flue which is used for exhausting fumes from appliances burning gas or other fuels.
- Do not overload your dryer beyond its rated capacity:

MODEL	MAXIMUM CAPACITY (KG)
DH9060P2	9
DH9060PG2	9

\*Capacity refers to the maximum dry weight of items the dryer can dry at any one time

- Never put dripping wet clothes in or on top of the dryer as excess water may cause an electrical hazard.
- Do not under any circumstances dry an electric blanket or any other electrical, plastic or rubber items in your dryer, unless the care label specifically states it is safe to do so. Never dry these items at high temperatures.
- Do not dry curtains in your dryer. Sunlight makes them brittle and they may disintegrate during drying.
- Do not use the water collected in the water tank for drinking or food processing.
- Never run the dryer without the water tank in place.
- If the water tank becomes full, the tumble dryer will pause drying and will sound an alarm. You must empty the water tank before the dryer can continue drying. Empty the tank, replace it back in the housing then press ►|| to resume the cycle.

### Lint

- Accumulated lint in the dryer can become a fire hazard; it also reduces the efficiency of the dryer by causing longer drying times and increased power consumption.
- Clean the lint filter before every load.
- Ensure the area around the dryer is clear of lint.
- At regular intervals have the interior of the dryer cleaned of any accumulated lint. This must be done by a Fisher & Paykel trained and supported service technician. This must be done when the dryer installation is changed from free standing.
- If the lint filter becomes damaged, contact your Fisher & Paykel trained and supported service technician to arrange getting a new filter. Do not operate your dryer with a damaged lint filter or without the filter in place, as this will cause damage to your dryer.

### Spontaneous combustion

To reduce the risk of fire in a tumble dryer the following should be observed:

- Items that have been spotted or soaked with vegetable oil or cooking oil are a fire hazard and should not be placed in a tumble dryer.
- Oil-affected items can ignite spontaneously, especially when exposed to heat sources such as a tumble dryer. The items become warm causing an oxidation reaction in the oil. This oxidation creates heat. If the heat cannot escape the items can become hot enough to catch fire. Piling, stacking or storing oil-affected items can prevent heat from escaping creating a fire hazard.
- If it is unavoidable that fabrics that contain vegetable oil, cooking oil or have been contaminated by hair care products be placed in a tumble dryer, they should first be washed in hot water with extra detergent – this will reduce, but not eliminate the fire hazard. The cool down cycle of the dryer should be used to reduce the temperature of these items. They should not be removed from the tumble dryer and piled or stacked while hot.

## SAFETY AND WARNINGS

---

- Items that have previously been cleaned in, washed in, soaked in or spotted with flammable liquids or solids, eg petrol/gasoline, kerosene, dry cleaning solvents, vegetable or cooking oil, acetone, denatured alcohol, some brands of spot removers, turpentine, waxes and wax removers or other flammable or explosive substances should not be placed in a tumble dryer.
- Do not dry unwashed items in the tumble dryer.
- The dryer is not to be used if industrial chemicals have been used for cleaning.
- Fabric Softeners or similar products should not be used in a tumble dryer to eliminate the effects of static electricity, unless this practice is specifically recommended by the manufacturer of the fabric softener product.
- Rubber backed articles, foam rubber (latex foam), clothes or pillows fitted with foam rubber pads, fibreglass, shoes containing rubber, shower caps, babies waterproof napkin covers and waterproof textiles should not be dried in the dryer. These materials can when heated produce fire by spontaneous combustion.
- When using STREAM REFRESH on unwashed clothing ensure there are no flammable substances on them.

### Disposal

- Extreme care must be taken when disposing of your old appliance to avoid hazards.
- When disposing of the dryer, it is recommended that the door is removed to avoid children getting trapped inside, and that the electrical cable is cut off close to the dryer.



# CONTROL PANEL

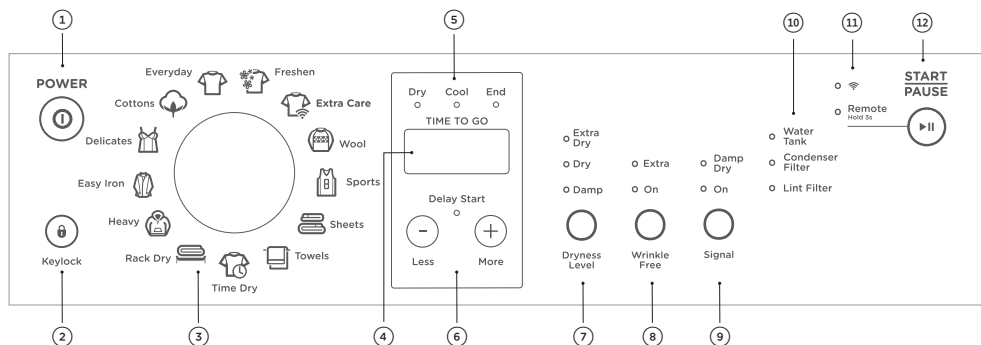

- |   |  |
|---|--|
| ① <b>POWER</b>                              | Press to turn the dryer ON/OFF.  |
| ② <b>Keylock</b>                            | Press and hold to disable all buttons on the display panel, except <b>POWER</b> button. This prevents accidental button presses.   |
| ③ <b>SmartTouch™ control dial</b>           | <p>Rotate to select your desired drying cycle.</p> <ul style="list-style-type: none"> <li>The icon illuminates to indicate the selected drying cycle.</li> </ul>   |
| ④ <b>Digital display screen</b>             | <p>Shows the following:</p> <ul style="list-style-type: none"> <li><b>TIME TO GO</b> - the remaining time in the cycle that is currently running.</li> <li>Delayed start time of dry cycle.</li> <li>Notifications if an error is detected or a warning is necessary.</li> </ul> |
| ⑤ <b>Progress lights</b>                    | <p>The progress lights indicate what part of the cycle the dryer has reached (<b>DRY</b>, <b>COOL</b> or <b>END</b>). All three lights are on at the start of the cycle. The light for the current part of the cycle flashes, and each one goes out as the cycle progresses.</p> |
| ⑥ <b>Delay Start Less/More</b>              | Press <b>MORE +</b> to increase and <b>LESS -</b> to decrease the delay start time.  |
| ⑦ <b>Dryness Level</b>                      | Allows you to select the level of dryness for your load.   |
| ⑧ <b>Wrinkle Free</b>                       | Allows you to select a <b>WRINKLE FREE</b> option for your cycle.  |
| ⑨ <b>Signal</b>                             | <p>This button has two functions:</p> <ul style="list-style-type: none"> <li>Alert you that the dryer has finished.</li> <li>Alert you to remove items once your load reaches the damp dry stage.</li> </ul>   |
| ⑩ <b>Water Tank, Condenser, Lint Filter</b> | The lights will flash when the dryer is switched on as a reminder to empty the water filter, or clean the condenser and lint filter. The warning light will also flash on and off during the cycle if the filters become blocked.  |
| ⑪ <b>WI-FI</b>                              | The LED beside  illuminates when functionality is activated.  |
| ⑫ <b>START/PAUSE</b>                        | Press to start or pause the selected drying cycle.   |

# CONTROL PANEL

## Timed cycles

When a timed cycle is selected the machine dries for the selected time regardless of the level of moisture in the load. It is important to check the items throughout the timed programmes to avoid over drying. Timed cycles include **TIME DRY**, **RACK DRY** and **WOOL**.

Timed programmes of 10 to 150 minutes can be selected using the **MORE +** and **LESS -** buttons.

## Airing/Cool down

Dry      Cool      End  
○          ○          ○

When the dryer has sensed that the load is dry it will automatically go into an airing or cool down cycle. During **COOL** the drum tumbles and cool air is blown through the clothes. This cools the load to reduce creasing if the clothes are left in the dryer.

## Time to go



Your dryer displays approximately how many minutes the cycle you are running has remaining if you have chosen one of the **TIME DRY** cycles. If you have chosen an automatic cycle (ie not **TIME DRY**) the word *AUTO* will appear on the screen until it reaches the cool down phase, at which time the dryer will display how long the cycle has left to go. A number of factors can influence the overall cycle time, eg the fabric type of garments, load size, the wetness of the load, environmental conditions etc.

## CONTROL PANEL

---

### Keylock

Keylock can be used to lock the buttons on your dryer when not in use. This will avoid accidental button pushes.

#### To turn Keylock ON or OFF:

①



Press  for two seconds.

When activated, the  button is illuminated.



#### If Keylock is ON and the dryer is turned OFF:

①



If a button is pressed while **KEYLOCK** is activated, the **KEYLOCK** button will flash.

#### To turn your dryer on:

Press **POWER** , then press and hold the **KEYLOCK**  two seconds. This will activate the control panel. Dry cycles and options can now be selected.

②



#### To stop or power OFF your dryer at any time:

Press **POWER** .

## WI-FI CONNECTION & REMOTE MODE

Your appliance may be connected to your home wireless network and operated remotely using the app. Connect your appliance to ensure it stays up to date with the latest software and features.

### Getting started

- Ensure your home Wi-Fi network and Bluetooth on your mobile device are turned on.
- You will be given step-by-step guidance on your mobile device.
- It may take up to 10 minutes to connect your appliance.

### On your mobile device:



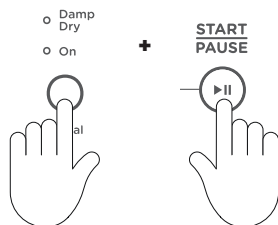

- ① Download the app. Scan the QR code or go to [www.fisherpaykel.com/connect](http://www.fisherpaykel.com/connect)
- ② Register and create an account.
- ③ Add your appliance and set up the Wi-Fi connection.

### Connecting to your home Wi-Fi



Ensure your appliance is powered on.

Press and hold ▶|| and **SIGNAL** buttons until the  LED starts to flash.

Once connected, the  LED will stop flashing and remain illuminated. Follow the instructions in the app to complete the connection.

### Enabling remote mode



Once Wi-Fi setup is complete, press and hold ▶|| for three seconds.

**REMOTE MODE** is now enabled. Certain functions of your appliance can now be accessed via the app.

For safety reasons, **REMOTE MODE** cannot be enabled if the door is open.

## WI-FI CONNECTION & REMOTE MODE

---

### Disabling remote mode



Press and hold ►|| for three seconds.

### Turning off your Wi-Fi

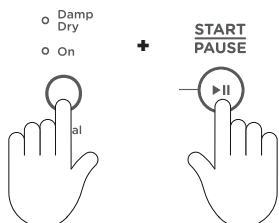













Press and hold ►|| and **SIGNAL** buttons simultaneously for three seconds to disconnect the Wi-Fi and switch off the LED.

Once Wi-Fi is turned off, you must reconnect to your home Wi-Fi and enable **REMOTE MODE** to access certain functions of your appliance via the app.

## DRY CYCLES

Your dryer has a number of dry cycles, selecting the most appropriate cycle for each load will help ensure you get the best drying result.

CYCLE	DESIGNED FOR	MAX LOAD (KG)	DEFAULT DRYNESS LEVEL*
 <b>Everyday</b>	Auto sensing cycle for mixed loads.	9	Dry
 <b>Cottons**</b>	Auto sensing cycle for cotton clothes.	9	Dry
 <b>Delicates</b>	Auto sensing cycle for delicate garments.	4	Dry
 <b>Easy Iron</b>	Auto sensing cycle that leave garments ready to iron with the WRINKLE FREE option automatically selected.	4	Damp/Dry
 <b>Heavy</b>	A longer, auto sensing cycle for durable garments.	9	Dry/ Extra Dry
 <b>Rack Dry</b>	Timed cycle for use with the drying rack, with options from 30 to 150 minutes for items that cannot be tumbled.	3	n/a
 <b>Time Dry</b>	Timed cycle with options from 30 to 150 minutes.	9	n/a
 <b>Towels</b>	Auto sensing cycle for drying bath and beach towels.	6	Dry
 <b>Sheets</b>	Auto sensing cycle with reversing to reduce tangling for large bedding items.	4	Dry
 <b>Sports</b>	Auto sensing cycle designed for sports garments.	4	Dry
 <b>Wool</b>	Timed cycle for use with drying rack, with options from 30 to 150 minutes for washable woollen items that cannot be tumbled.	3	n/a
 <b>Extra Care</b>	Auto sensing cycle for ultra delicate and heat sensitive garments.	1	Dry
 <b>Freshen</b>	A 15 minute cycle with a burst of heat to refresh dry items.	2	n/a

\*Dryness level is only an option on automatic sensing cycles. On **TIME DRY** and the **RACK DRY**

\*\***COTTONS** cycle and **DRY** dryness level is the recommended cycle for everyday cotton items.

## DRY PREPARATION

---

### Sorting

Sort your garments before placing them into the dryer. Sort into loads of similar items, and loads that will likely take similar times to dry. Heavier items (eg towels, and flannelette sheets) are best dried separately from lightweight items (eg synthetics, polyester-cotton sheets and shirts). This prevents the possibility of some items becoming over-dried whilst others are still damp. It will also help to extend the life of your clothing and linen.

Care labels on garments provide valuable information about the fabric type and how the garment should be dried. Always follow the advice on the garment labels. Only dry items in this dryer that have a care label stating tumble drying is suitable.

Drying your clothes as soon as you remove them from the washer will decrease the chance of wrinkles forming, and dye transfer from coloured items to white items from occurring.

Separate coloured items from white/light items where possible, especially when new. Colour run may be an issue, especially if you intend to delay the start of the drying cycle.

<b>SPECIFIC ITEM/DRYING REQUIREMENTS</b>	<b>SUGGESTED CYCLE AND OPTIONS</b>	<b>COMMENTS</b>
Towels	Towels	Towels produce a lot of lint and are best dried on their own.
Sheets, pillowcases, duvet/ doona covers	Sheets	Ensure duvet/doona cover openings are buttoned/ domed before placing in the dryer.
Bulky items - doonas, duvets, sleeping bags, jackets	Sheets	Dry only one bulky item at a time and place a knotted towel into the dryer at the same time to ensure the bulky item moves around evenly.
Business shirts, trousers, other creasables	Easy Iron	<b>WRINKLE FREE</b> is automatically selected to help minimise creasing once the drying cycle has finished.
Woolens, silks	Wool	Designed for items that could be damaged if they are tumbled, eg woolens. Use the drying rack.
Delicates, fine fabrics	Delicate or Rack Dry	You can further reduce the dryness level to damp or use <b>RACK DRY</b> for very delicate items.
Jeans	Heavy	Turn jeans inside out to help maintain their appearance. Dry separately from other items.
Shoes, hats, soft toys or other odd shaped items	Rack Dry	Check on the item regularly throughout the drying cycle. Ensure the rack has been correctly fitted.

## DRY PREPARATION

---

### Before you load

- Check pockets for items that could damage your clothes or get caught in the dryer.
- Close zippers, hooks and eyes, and other fastenings (ie fasten the openings of duvet/doona covers), and remove loose bra wires. These may damage both your dryer and your clothes.
- Items of clothing with screen-printing should be turned inside out to prevent damage to the print.
- Check the lint filter is clean and the water tank is empty (if the dryer is not set up to drain automatically).

### Loading

- Garments need to be loaded correctly to minimise creasing and wrinkling, and to ensure the load is dried evenly.
- Allow enough room in the dryer for clothes to tumble freely. Load the dryer in terms of the space the garments take up when dry, rather than when they are wet.
- Shake clothes out and load individually to help items dry evenly and reduce tangling.
- Dry permanent press garments (business shirts) together on the **EASY IRON** cycle with the **WRINKLE FREE** option on. This will help reduce wrinkling and the need for ironing. Hang garments as soon as the drying cycle is complete to reduce the need for ironing.

### Drying times

- Drying very small loads is inefficient. Try to dry medium to large loads.
- Heavier items (towels, flannelette sheets) will take longer to dry than light items (synthetics and polyester cotton sheets and shirts).
- Drying times can be reduced by spinning the wash load at the highest spin speed suitable for the load type in your washing machine.
- Check bulky items during the cycle to ensure even drying, pause the dryer and reposition the item if necessary.

### Lint

Some items are lint givers, while others are lint collectors. Always dry lint givers and collectors separately.

LINT GIVERS	LINT COLLECTORS
Towels	Synthetics, eg polar fleece
Flannelette sheets	Corduroy
	Polyester cottons

Delicate or easily damaged items (eg nylon stockings, fine fabrics, delicate embroidered fabrics) should be dried separately, using the **DELICATE** or **WOOL** cycle, or if you do not want them tumbled use the **RACK DRY** cycle.



## DRY PREPARATION

### Drying rack

There are many items that would benefit from being dried on a drying rack. For example items such as sport shoes, soft toys, hats and woollen items that may be damaged if they are tumbled.

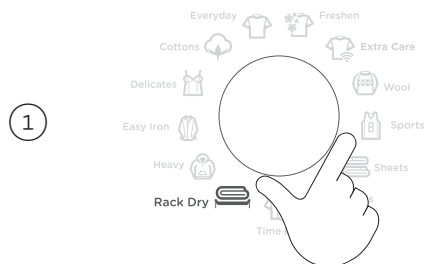

The drying rack is installed in your dryer when it leaves the factory.

When you are using the drying rack you must select the **RACK DRY** or **WOOL** cycle.

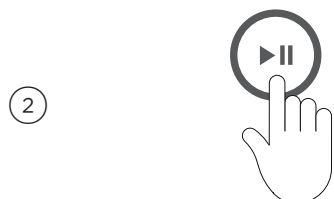

If the rack is not properly installed or if a garment has fallen from it, a user prompt will appear on the digital display screen. Replace the rack and press ▶|| to resume the cycle.

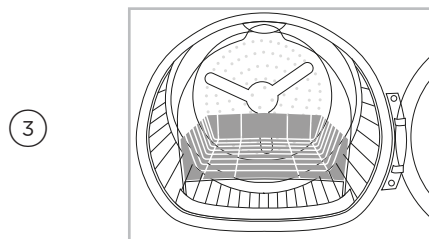

To remove the drying rack, tilt the top of the rack towards you this will detach the legs from the slots in the lint filter, gently remove from the drum.

## GETTING STARTED QUICKLY

Check the lint and condenser filters are clean and replaced correctly before every load. Ensure the water tank is empty or drain hose secure before using your dryer.

Sort and load items into the dryer drum, ensuring no items are in the way of the door. Close the door (you will hear it click shut).

1



Press **POWER**  to activate your dryer.

2



Select your desired drying cycle by turning the SmartTouch™ Control Dial.

3

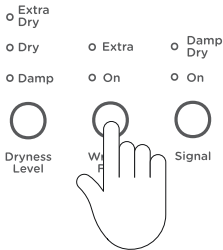

Select your preferred drying options (if you wish to select options different from the default options for the cycle).

If you make an invalid selection the dryer will beep to alert you.

4



Press **▶||** to start the cycle.

## GETTING STARTED QUICKLY

---

4



If you wish to change a cycle or select a different option once a drying cycle has started, press ►|| then select the new cycle or option.

Press ►|| to restart the dryer with the new cycle and/or settings.

When the cycle finishes, your dryer will beep and then turn off automatically. If the **WRINKLE FREE** option has been selected the dryer will rotate the drum periodically blowing cool air into the drum to help minimise wrinkling and creasing of your load.

If you wish to stop the dryer before the cycle has finished you **MUST** remove the clothes **IMMEDIATELY** and spread them out to cool. **DO NOT** leave the clothes in the dryer or bunched up in a clothes basket. Take extreme care as the drum and the load items may be extremely hot.

Failure to follow the advice in this guide may result in damage to your garments and your expectations of drying performance may not be met.

## DRYING CYCLE OPTIONS

All drying cycles default to the recommended options for that cycle based on the average expected load to be dried using that cycle. You can vary the options (eg **DRYNESS LEVEL**, **DRY TEMP**) to create your desired cycle. Some options are not available on some cycles, for clothes care reasons, or because the option is not appropriate for the cycle.

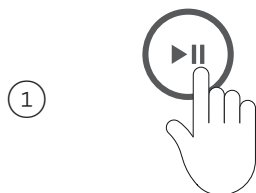

To change a drying option or options you have selected after a cycle has started, press ►|| and select your new setting, then press ►|| again to resume the cycle with the new settings.

### Dryness Level



When your dryer senses that the clothes have dried to the dryness level selected, the dryer will automatically finish the cycle.

Two lights are used to show some dryness levels, eg to achieve the **DAMP DRY** setting both the **DRY** and the **DAMP** lights will be illuminated.

There are five dryness levels that can be selected from **DAMP** through to **EXTRA DRY**. You can alter the dryness level from the default to suit your load depending on how dry you want your items to be.

### Wrinkle Free

To minimise wrinkling, select one of the **WRINKLE FREE** options.

- **ON** provides wrinkle free operation for 1 hour.
- **EXTRA** provides wrinkle free operation for 24 hours.

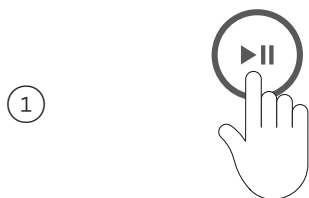

To stop the dryer at any point during the **WRINKLE FREE** stage of the cycle, press ►||. You can then open the dryer door and remove your items.

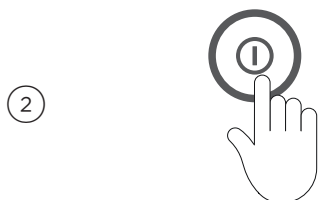

Press **POWER** ① to turn off your dryer.

## DRYING CYCLE OPTIONS

### Signal

The **SIGNAL** option automatically defaults to on for all cycles.

1



To turn the **SIGNAL** off press the **SIGNAL** button twice (no lights will illuminate).

2



To turn the **SIGNAL** on press the **SIGNAL** button once.

### Delay Start

The **DELAY START** option can delay the start of the dry cycle between 15 minutes and 12 hours.

1

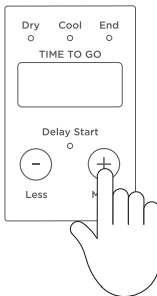

Press **MORE +** to increase the delay time, and **LESS -** to decrease the time, or turn **DELAY START** off.

2



Press **▶||** to confirm your selection and start the countdown. The display screen will show the time until the cycle is set to begin.

Avoid using **DELAY START** for damp, non-colourfast items as this may cause dye run to occur. **DELAY START** is not available for **QUICK 30** and **FRESHEN** cycles.

## CUSTOMISING A DRY CYCLE

After using your dryer a few times you may discover there are some drying options you prefer for some cycles. You can programme your dryer to remember the drying options you prefer for each drying cycle. For instance, you may want to set the **EASY IRON** cycle to a different dryness setting or programme the **EVERYDAY** cycle so it automatically has the **WRINKLE FREE** option selected.

### To customise a cycle



Press **POWER** ① to activate your dryer.



Turn the dial to select the dry cycle you wish to customise.

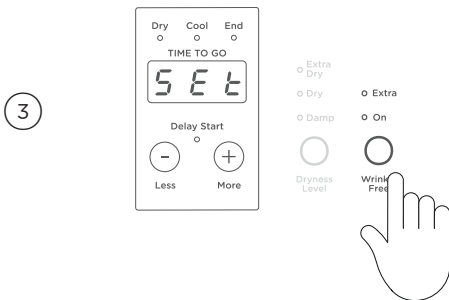

Press the button of the option you want to customise (eg **WRINKLE FREE**) for three seconds. The lights will flash and the display will show **5 E L** to indicate that the dryer is in option adjustment mode.

## CUSTOMISING A DRY CYCLE

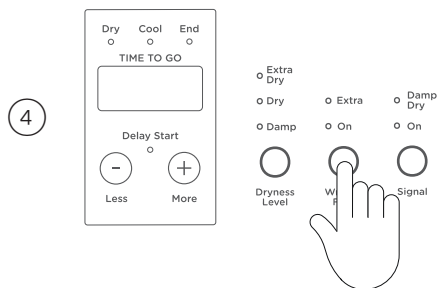

Select your preferred setting for this option. Only a single dry cycle option can be customised at a time.



Press **Lock** once to save your customised cycle. A long beep will sound to confirm that your changes have been saved.

Ensure the customised dry cycle option is saved before customizing any other options.

To customise other dry cycle options or change the saved settings, simply repeat these steps.

### Reset defaults

You can reset your dryer to the default settings it left the factory with:

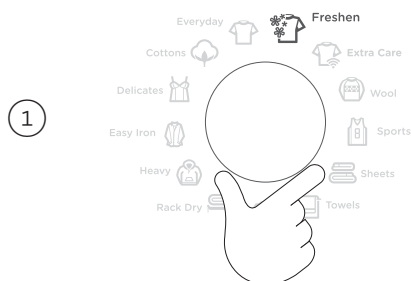

Turn the dial to select the **FRESHEN** cycle.

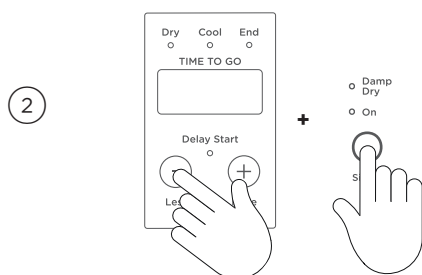

Press **MORE +**, **LESS -** and **SIGNAL** together for three seconds.

Your dryer will now be reset to the default settings it left the factory with.

## CARING FOR YOUR DRYER

---

### When you have finished using your dryer

- Unplug the dryer from the power socket.
- Wipe around the door to remove any remaining condensation and foreign matter.
- Clear the lint and condenser filters and empty the water tank (if not set up to automatically drain).

### Cleaning the control panel and outer surfaces of the dryer

Use a soft damp cloth to wipe all surfaces, then wipe dry. Avoid using chemical or scouring cleaners, as these will damage the paint and plastic surfaces of your dryer.

### Cleaning the inside of your dryer

It is important to occasionally clean the inside of your dryer. If the drum has any residual dirt or lint stuck to it, remove this and wipe it clean with a damp cloth. Do not leave any metal objects in the drum, as these may cause rust.

### Cleaning the filters

#### Cleaning the door lint filter

Lint is generally formed during wearing and washing. Fibres (ie lint) released from the clothes during the drying cycle are collected in the lint filter.

It is important to clean the door lint filter after every load, as the lint produced in the drying process can become a fire hazard if it is allowed to accumulate in or around your dryer.

A warning light will flash at the start of every cycle to remind you to clean the door lint filter, then turns off once you press ►|| to start your cycle. The warning light will flash on and off during the cycle if the door lint filter becomes blocked. When this occurs the lint filter should be cleaned immediately.

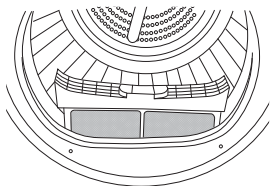

The door lint filter is located in the door opening (at the bottom).



## CARING FOR YOUR DRYER

To clean the door lint filter:

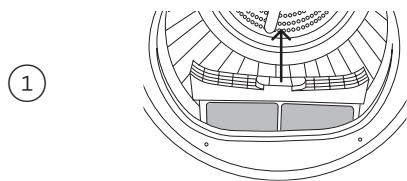

Open the dryer door.

Remove the lint filter by pulling it up and out of the filter slot.

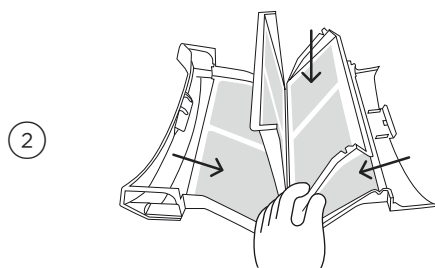

Open it out and wipe the surfaces clean with your hand or a soft cloth.

Close the lint filter and place it back in the opening. Ensure the filter is fitted correctly back in place before operating the dryer.

### Cleaning the condenser filter, foam and evaporator grid

To maintain optimum performance of your dryer the condenser filter, foam and evaporator grid must be cleaned. The condenser filter and lint filter lights will flash when the condenser filter requires cleaning, then turn off once you press ►|| to start your cycle.

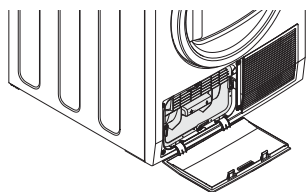

#### Condenser filter

The condenser filter is located below the door on the left-hand side.

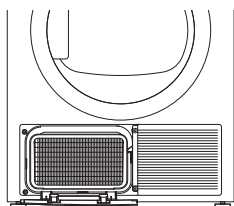

#### Evaporator grid

The evaporator grid is located behind the condenser filter.

## CARING FOR YOUR DRYER

To clean the condenser filter:

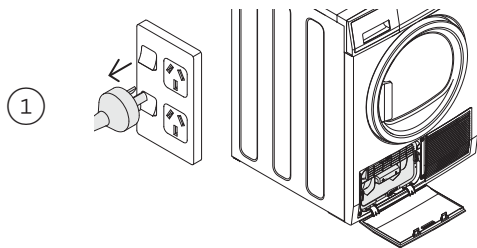

Switch off the power supply and remove the power plug.

Open the condenser filter cover.

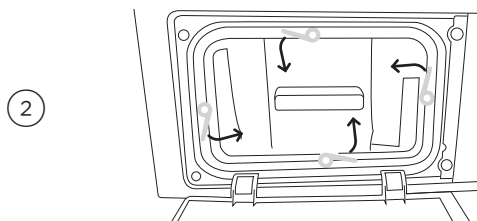

Turn the four condenser lock levers 90° then pull out the condenser filter.

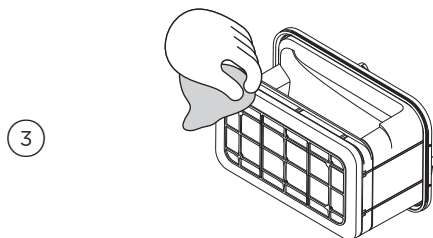

Use your hand, a cloth or a vacuum with a crevice nozzle to remove any lint build-up from the mesh surface of the filter.

## CARING FOR YOUR DRYER

---

To clean the filter foam:

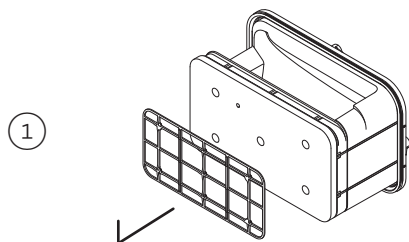

Remove the bracket securing the foam to condenser filter.

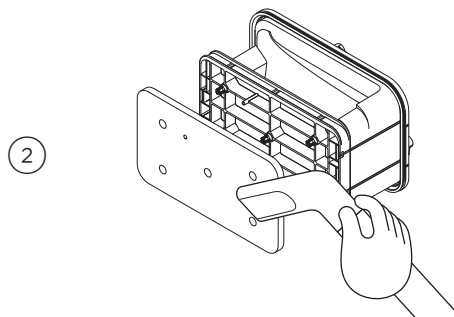

Remove the foam and vacuum lint build-up with a crevice nozzle.

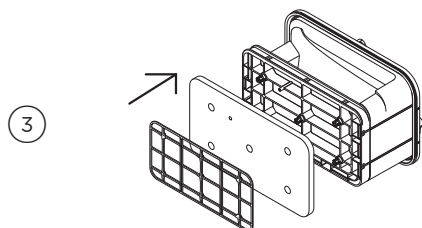

Replace the filter foam and secure with the bracket.

The condenser filter foam should be replaced regularly, three filter foams are provided with your dryer. Further replacement filter foam can be purchased from [fisherpaykel.com](http://fisherpaykel.com) or from your Fisher & Paykel trained and supported service technician.

## CARING FOR YOUR DRYER

---

### To clean the evaporator grid:

With the condenser filter removed you will be able to see the evaporator grid.

**Cut Hazard.** The surface of the evaporator has sharp edges and contact may result in injury. Handle with care when cleaning the grid and always keep blades away from fingers and body.

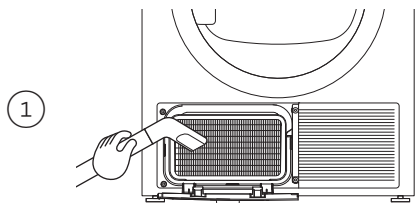

If the surface of the evaporator grid is dirty, clean it carefully with a vacuum cleaner using a dusting brush or a narrow crevice tool. Be gentle and do not bend the fine metal fins.

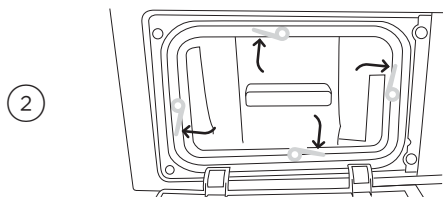

Replace the condenser filter.

Turn the four condenser filter lock levers to lock the condenser filter back in place. Ensure the locks are engaged securely.

Close the condenser filter cover.

## CARING FOR YOUR DRYER

---

### Cleaning the sensors

There are sensors in your dryer that detect whether the laundry is dry or not. These sensors need to be cleaned periodically (we recommend approximately four times a year).

To clean the sensor:

1

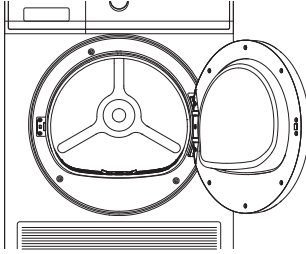

Open the door of your dryer. Allow the dryer to cool if drying has been carried out.

2

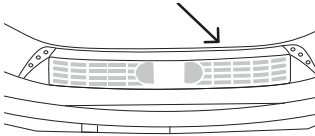

Locate the metal sensors just behind the lint filter.

3

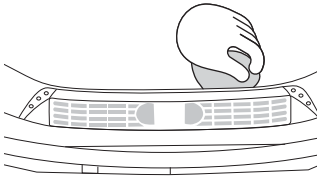

Wipe the sensors with a soft cloth, dampened with vinegar and dry with a clean dry soft cloth.

## CARING FOR YOUR DRYER

---

### Emptying the water collection tank

During the drying cycle, steam condenses into water and is collected in the water tank, located at the top left of the dryer. It is important to empty the water tank after every load.

If the water tank becomes full during operation, the dryer will pause, display a user prompt and beep to alert you.

#### To empty the water tank:

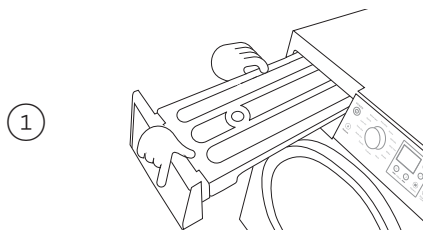

Remove the water tank by holding onto the handle and pulling outwards gently. Ensure the tank is kept level when removed to prevent the water from spilling.

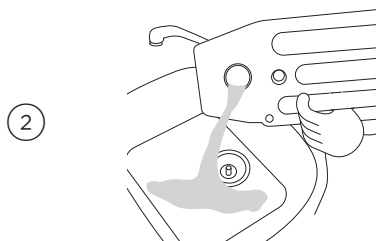

Pour the water down the sink or into a bucket, and then put the tank back in place.

**Never run the dryer without the water tank in place unless the drain hose has been installed.**

You do not need to empty the water tank if you have set up the drain hose to drain the water automatically.

## BEFORE YOU CALL FOR SERVICE

### User warnings

Your dryer is capable of diagnosing a number of its own problems. It will sound a continuous series of beeps and display a user prompt when it has a problem that you can correct yourself. To stop the beeps sounding, press any button on the control panel. Do not try to continue your drying cycle once you stop the noise. You must address the problem the dryer is alerting you to.

Check the below table before you call for service.

PROBLEM	DISPLAYED AS	WHAT TO DO
Keylock is activated	KEY LOC	Press  for two seconds to deactivate the KEYLOCK.
Clean lint filter	<ul style="list-style-type: none"> <li><input type="radio"/> Water Tank</li> <li><input type="radio"/> Condenser Filter</li> <li><input checked="" type="radio"/> Lint Filter</li> </ul>	Refer to page 24 'Cleaning the door lint filter'.
Clean condenser filter	<ul style="list-style-type: none"> <li><input type="radio"/> Water Tank</li> <li><input checked="" type="radio"/> Condenser Filter</li> <li><input type="radio"/> Lint Filter</li> </ul>	Refer to page 25 'Cleaning the condenser filter, foam and evaporator grid'.
The lint and/or condenser filter is blocked and needs to be emptied	c In both lint FLTR	<p>Empty the lint filter and then replace it.</p> <p>Check the lint filter is not damaged.</p> <p>Check there is nothing else stuck in the lint filter holder which may be blocking the air flow.</p> <p>Check the lint filter is in place correctly in your dryer.</p> <p>Clean the condenser filter and the foam filter (refer to 'Caring for your dryer'). Ensure the foam filter has been replaced correctly on the condenser filter. Ensure the condenser filter unit has been placed or replaced correctly into your dryer.</p> <p>If the error continues you may need to replace the filter foam, refer to 'Clean the filter foam' for details.</p>
The water tank is full and needs to be emptied	H2O FULL	<p>Check if the water tank is full.</p> <p>Empty the water tank.</p> <p>If using the drain hose, check whether the water tank or drain hose is blocked.</p> <p>Check the drain hose is still attached at the back of the dryer, and is not kinked or squashed.</p>

## BEFORE YOU CALL FOR SERVICE

---

**The door is  
not closed**

*door*

Close the door fully and press ►II.

Try opening and closing the door again.

Reposition the load, ensure the load is correctly in the drum and that protruding items are not preventing the door from closing.

**The drying  
rack is not  
in place**

*Fit  
rack*

Fit the drying rack.

Once you have addressed the issue the user prompt was alerting you to, try using your dryer as per usual. If the issue persists, call your Fisher & Paykel trained and supported service technician.



## FAULT CODES

---

**When a continuous series of beeps sound, all the lights turn off on the control panel and a number appears on the display, a fault has occurred.** The dryer will automatically enter this mode if a fault occurs. The word **FAULT** will be shown in the control panel display followed by a number. To stop the beeps, press any button then perform the following steps:

- ① Turn your dryer off at the power point.
- ② Wait one minute and turn it back on.
- ③ Check your dryer is installed correctly, refer to your separate installation guide.
- ④ Remove your load from the dryer and retry.
- ⑤ Perform a **TIME DRY** cycle, eg **TIME DRY** for 30 minutes.
- ⑥ If the fault re-occurs repeat steps ① and ②.
- ⑦ If the dryer still will not work call a Fisher & Paykel trained and supported service technician to arrange service, refer to 'Before you call for service'. Record the fault code number displayed and the serial number of your dryer (located on the rear of the dryer, or on the inside of the door below the glass) before calling. The fault code will indicate to the service technician what the problem could potentially be.

If a fault code is being displayed, you can still turn your dryer off by pressing **POWER** ①.

## TROUBLESHOOTING

The following is a list of problems you may encounter when using this appliance and some suggestions that may help to correct the problem. If you still have problems, contact your Fisher & Paykel trained and supported service technician.

PROBLEM	POSSIBLE CAUSES	WHAT TO DO
<b>Pressing POWER ① does not turn on the dryer</b>	Fault with household power supply.	Try plugging in and turning on another electrical device.
<b>Dryer does not heat</b>	Full water tank.	Refer to 'Emptying the water collection tank'.
	The dryer has progressed to <b>COOL</b> .	Check the progress lights - are <b>COOL</b> or <b>END</b> lights illuminated? Refer to 'Control panel'.
<b>Pressing ►II does not start the drying cycle</b>	Dryer door not closed properly.	Open and close the door. Check that the lint filter is correctly in place and not obstructing the door.
	Is the dryer displaying a user warning or fault code?	Refer to 'User warnings' and 'Customising a dry cycle'.
	Water tank full or not properly in place.	Refer to 'Emptying the water collection tank'. Ensure the water tank is properly in place.
	Dryer is overloaded.	Remove some items from the dryer.
	<b>DELAY START</b> function is set.	Refer to 'Delay Start' for more information.
	<b>KEYLOCK</b> is ON.	To disable press <b>🔒</b> for three seconds.
<b>Dryer keeps stopping and starting</b>	The <b>WRINKLE FREE</b> option has been selected.	Refer to 'User warnings' for more information.
<b>Dryer stops working mid-cycle</b>	Power failure.	Press <b>POWER ①</b> and restart the desired cycle.
	Dryer has been paused.	Press <b>►II</b> to restart the cycle.
	Dryer door is open.	Ensure the door is firmly shut.
	Items fell off the rack when using <b>RACK DRY</b> cycles.	Ensure the rack is installed correctly (refer to 'Drying rack') and replace garments that may have fallen from it.

## TROUBLESHOOTING

PROBLEM	POSSIBLE CAUSES	WHAT TO DO
<p><b>Dryer is taking too long.</b></p> <p><b>Results were not satisfactory.</b></p>	Drying cycle selected not appropriate for the load.	Select an appropriate cycle for the load. Refer to 'Drying rack'.
	Dryness level selected not appropriate for the load.	Select a higher dryness level. Refer to 'Lint'.
	Dryer overloaded for the cycle.	Some cycles have a lower max load size. Refer to 'Drying rack'.
		Try dividing the load in half and dry half at a time.
	Lint filter, condenser filter, filter foam or evaporator grid is blocked.	Clean the lint filter, condenser filter, filter foam and evaporator grid. If the problem continues the foam filter may need to be replaced, refer to 'Clean the filter foam'.
	Water tank is full.	Refer to 'Emptying the water collection tank'.
	Environmental conditions may be affecting dryer operation.	In particularly hot or cold conditions the dryer will take longer to dry a load and be less efficient. Ensure the dryer is installed in a well-ventilated, dust-free environment. Do not operate this dryer behind closed doors (ie inside a cupboard).
	Load overly wet at the start of cycle.	Remove more water from the load before placing it in the dryer, eg select a faster spin speed on your washer, if appropriate for your load.
Load was damp dry at the start of cycle.	If the load had been partially air dried, eg has been washed and placed on the line, use a <b>TIME DRY</b> cycle and monitor the dryness of your clothes.	
Dryer not draining water out properly.	Check the drain hose (if connected) for blockages or damage. You may need to call for service refer to 'Before you call for service'.	
Items got tangled.	Try separating items and drying similar items together. Refer to 'Loading' for further tips.	

## TROUBLESHOOTING

PROBLEM	POSSIBLE CAUSES	WHAT TO DO
<b>Dryer is not draining</b>	Drain hose not connected to the water tank.	Ensure the drain hose is connected correctly. Refer to your installation guide for guidance on draining.
	Water tank not in place correctly.	Ensure water tank is properly in place.
	Drain hose or drain blocked or damaged.	Check drain hose (if connected) and drain for blockages or damage.
<b>Clothes getting too hot or damaged</b>	Cycle selected not appropriate for the load.	Ensure the cycle selected is appropriate for items in the load. Refer to 'Drying rack'.
	Items removed from dryer before the end of cycle cool down had finished.	Removing items before cool down may damage clothing if it is not spread out and exposed to air to cool once removed from the dryer.
<b>Dryer is beeping and displaying a code on the digital display</b>	Dryer has a fault.	Try turning the dryer off and waiting one minute before turning it back on. Refer to 'Customising a dry cycle'.
<b>Small puddle of water coming from under the dryer</b>	Water tank not correctly in place.	Ensure the water tank is correctly in place.
	Water tank may need to be emptied.	Refer to 'Emptying the water collection tank'.
	Water tank may be damaged.	Check the water tank for any signs of damage.
	Drain hose may not be attached properly at the dryer end.	Ensure the drain hose is attached properly. Refer to your installation guide for guidance on draining.
	Drain hose could be damaged.	Check the drain hose for damage.
	Drain hose has slipped out of the drain.	Ensure the drain hose is securely fixed in place. Sometimes drain hoses can move or get displaced, which may lead to water draining onto the floor.
	Drain may be blocked.	Check the drain for any blockages.
	Dryer door not closing properly, affecting the seal.	Ensure the dryer door is closed properly and there is nothing obstructing the door opening.
	Inlet hose not correctly tightened.	Check inlet hose and tighten connection if necessary.

## TROUBLESHOOTING

PROBLEM	POSSIBLE CAUSES	WHAT TO DO
Small amount of water in the drum at end of cycle	Water tank needs to be emptied.	Refer to 'Emptying the water collection tank'.
	Environmental conditions may be affecting dryer operation.	If conditions are particularly hot, humid or cold, it is possible vaporised water may re-condense in the drum or on the inside of the door.
Noises	Dryer is overloaded.	Remove some items from the dryer.
	Dryer has a fault.	Continuous beeping or a musical series of beeps with a message displayed on the display. Refer to 'Customising a dry cycle'.
	Beeps signalling the end of a drying cycle.	End of cycle beeps can be turned off. Refer to 'Drying cycle options'.
	Dryer has not been levelled properly.	Refer to your installation guide for guidance on levelling.
	Dryer makes unfamiliar noises.	At the start of the cycle the dryer may make some unfamiliar noises when the compressor turns on. This is normal.
Vibration	Dryer is not installed on a stable surface.	Ensure the dryer is installed on a flat, stable surface. Refer to your installation guide for guidance on levelling.
	Dryer is not level.	Ensure the dryer is correctly levelled. Refer to your installation guide for guidance on levelling.
	Dryer is overloaded.	Remove some items from the dryer.
Creasing	Cycle selection not appropriate for the load.	Select the <b>EASY IRON</b> cycle to minimise creasing.
	Dryer is overloaded.	Remove some items from the dryer.
	<b>DRYNESS LEVEL</b> selected too high for load type.	Try selecting a lower <b>DRYNESS LEVEL</b> .
	<b>WRINKLE FREE</b> option not selected.	Select the <b>WRINKLE FREE</b> option to rotate the load at the end of the drying cycle. Refer to 'User warnings'.
Dye transfer	White/light and coloured items not separated before drying.	Remember to separate white/light and coloured items before placing them in the dryer.
	Wet items left sitting in the dryer for long periods of time before drying.	Refer to 'Sorting' for tips to prevent dye transfer.

## TROUBLESHOOTING

PROBLEM	POSSIBLE CAUSES	WHAT TO DO
<b>Linting</b>	Lint filter not cleaned or replaced.	Ensure the lint filter is cleaned after every cycle and replaced correctly. Refer to 'Cleaning the filters'.
	Loads not sorted correctly.	Dry lint-giving items separately from lint receivers. Also, dry similar colours together, eg light coloured items with light coloured items, dark items with dark items. Refer to 'Sorting', 'Lint'.
	Clothes over dried.	Over drying clothes in the dryer can cause them to attract lint. Use an auto sensing cycle or ensure you check your load if using the time dry cycles to avoid over drying. Refer to 'Drying rack'.
	New items have been dried in the dryer recently.	Clean the lint filter and use <b>TIME DRY</b> cycle to clear any remaining lint from the dryer.
	New towels or flannelette sheets can leave lint in the dryer, which may be picked up by subsequent loads.	
<b>Fabric damage</b>	Instructions on care label not followed.	Follow the instructions on the care label of the items.
	<b>DRYNESS LEVEL</b> selected not appropriate for the fabric type.	Ensure the <b>DRYNESS LEVEL</b> selected is appropriate for the fabric type. Refer to the items care label. Refer to 'Drying rack'.
	Metal parts on the items or in the load.	Fasten zips and other clasps before placing items in the dryer.
	Items not separated or dried on an appropriate cycle for the fabric type.	Dry similar items together. Ensure an appropriate cycle is selected. Refer to 'Drying rack'.
	Items fell off the rack when using <b>RACK DRY</b> .	Ensure the rack is installed correctly (refer to 'Sorting', 'Drying rack') and only one or two garments are placed on the rack at a time.
	Used a <b>TIME DRY</b> cycle and did not monitor the dryness of clothes during the cycle.	Ensure that clothes are checked for dryness during the cycle when using the timed programmes to avoid over drying.

## TROUBLESHOOTING

PROBLEM	POSSIBLE CAUSES	WHAT TO DO
Tangling	Loads not separated during loading.	Try separating out larger items from smaller items.
	Items loaded into the dryer incorrectly.	Load items individually into the dryer. Do not place folded items in the dryer.
	Incorrect cycle selection.	Try using the <b>EASY IRON</b> cycle to dry shirts and the <b>SHEETS</b> cycle to dry sheets. Refer to 'Drying rack'.
	Load size too large.	Try drying smaller load sizes. Some cycles have a lower maximum load size. Refer to 'Drying rack'.
	Delicate items not dried on <b>RACK DRY</b> .	Dry pantyhose, bras, stockings and any other delicate items prone to tangling on the <b>RACK DRY</b> cycle.
	Sheets and duvet/doona covers due to their size, are prone to tangling.	Dry sheets and duvet/doona covers separately from other laundry, apart from towels. Ensure duvet/doona covers are buttoned or fastened closed before drying. Try adding a knotted towel to sheets loads if you are experiencing a lot of tangling.

## MANUFACTURER'S WARRANTY

---

For New Zealand and Australia only. You automatically receive a 2 year Manufacturer's Warranty with the purchase of this heat pump clothes dryer covering parts and labour for servicing within the country of purchase.

### **Fisher & Paykel undertakes to:**

Repair or, at its option, replace without cost to the owner either for material or labour any part of the product, the serial number of which appears on the product, which is found to be defective within TWO YEARS of the date of purchase.

Note: This Manufacturer's Warranty is an extra benefit and does not affect your legal rights.

### **This Manufacturer's Warranty DOES NOT cover**

- Ⓐ Service calls which are not related to any defect in the product. The cost of a service call will be charged if the problem is not found to be a product fault.  
For example:
  - ① Correcting the installation of the product.
  - ② Instructing you how to use the product.
  - ③ Replacing house fuses or correcting house wiring or plumbing.
  - ④ Correcting fault(s) caused by the user.
  - ⑤ Noise or vibration that is considered normal, eg drain/fan sounds, machine noises or user warning beeps.
  - ⑥ Correcting damage caused by pests, eg rats, cockroaches, etc.
  - ⑦ Poor drying performance due to incorrect installation and maintenance eg blocked lint filter, blocked condenser or full water tank.
  - ⑧ Poor drying performance due to incorrect loading, eg overloading or underloading.
  - ⑨ Damage from articles in the drum, eg bra wires, pens, crayons, dye transfer or flammable material.
- Ⓑ Defects caused by factors other than:
  - ① Normal domestic use; or
  - ② Use in accordance with the product's User guide.
- Ⓒ Defects to the product caused by accident, neglect, misuse or 'act of God'.
- Ⓓ The cost of repairs carried out other than by a Fisher & Paykel trained and supported service technician or the cost of correcting such repairs.
- Ⓔ Normal recommended maintenance as set out in the product's User guide.
- Ⓕ Repairs when the appliance has been dismantled, repaired or serviced by other than a Fisher & Paykel trained and supported service technician or the selling dealer.
- Ⓖ Pick-up and delivery.
- Ⓖ Transportation or travelling costs involved in the repair when the product is installed outside the Fisher & Paykel trained and supported service technician's normal service area.

Nothing in this Manufacturer's Warranty is intended to, or does, limit any rights you may have under law to recover the costs of inspecting or returning the goods to us.



## MANUFACTURER'S WARRANTY

---

This product has been designed for use in a normal domestic (residential) environment. This product is not designed for commercial use (whatsoever). Any commercial use by a customer will affect this product's Manufacturer's Warranty.

Service under this Manufacturer's Warranty must be provided by a Fisher & Paykel trained and supported service technician (refer to the 'Before you call for service'). Such service shall be provided during normal business hours. This Manufacturer's Warranty certificate should be shown when making any claim.

### **For Australian Customers**

This Manufacturer's Warranty is an extra benefit and does not affect your legal rights. Our goods come with guarantees that cannot be excluded under the Australian Consumer Law. You are entitled to a replacement or refund for a major failure and for compensation for any other reasonably foreseeable loss or damage. You are also entitled to have the goods repaired or replaced if the goods fail to be of acceptable quality and the failure does not amount to a major failure.

**Please keep this user guide in a safe place.**

## CUSTOMER CARE

---

### **Before you call for service or assistance**

Check the things you can do yourself. Refer to your User guide and check:

- ① Your product is correctly installed.
- ② You are familiar with its normal operation.
- ③ You have read the 'Customising a dry cycle' and 'Troubleshooting' sections.

If after checking these points you still need assistance or parts, please refer to your nearest Fisher & Paykel trained and supported service technician, Customer Care, or contact us through our website [fisherpaykel.com](http://fisherpaykel.com).

### **In New Zealand if you need assistance\***

Call the Fisher & Paykel Customer Care Centre and talk to one of our Customer Care Consultants.

**Toll Free:** 0800 FP CARE or 0800 372 273

**Fax:** (09) 273 0656

**Website:** [fisherpaykel.com](http://fisherpaykel.com)

**Postal address:** Fisher & Paykel Appliances Ltd, PO Box 58550, Botany, Auckland 2163

### **If you need service\***

Fisher & Paykel has a network of Fisher & Paykel trained and supported service technicians that can carry out any service necessary on your appliance. Our Customer Care Centre can recommend a Fisher & Paykel trained and supported service technician in your area.

### **In Australia if you need assistance\***

Call the Fisher & Paykel Customer Care Centre and talk to one of our Customer Care Consultants.

**Toll Free:** 1300 650 590

**Fax:** (07) 3826 9298

**Website:** [fisherpaykel.com](http://fisherpaykel.com)

**Postal address:** Fisher & Paykel Appliances Australia Pty Ltd, PO Box 798, Cleveland QLD 4163

### **If you need service\***

Fisher & Paykel has a network of Fisher & Paykel trained and supported service technicians that can carry out any service necessary on your appliance. Our Customer Care Centre can recommend a Fisher & Paykel trained and supported service technician in your area.

\*If you call, write or contact us via our website please provide: your name and address, model number, serial number, date of purchase and a complete description of the problem. This information is needed in order to better respond to your request for assistance.

**Product details can be found on the rear of the dryer, and/or on the inside of the door below the glass (when the door is open).**

## CUSTOMER CARE

---

### Registration

Register your product with us so we can provide you with the best service possible.  
To register your product visit our website: [fisherpaykel.com/register](http://fisherpaykel.com/register)

Complete and keep for safe reference:

Model \_\_\_\_\_

Serial No. \_\_\_\_\_

Purchase Date \_\_\_\_\_

Purchaser \_\_\_\_\_

Dealer \_\_\_\_\_

Suburb \_\_\_\_\_

Town \_\_\_\_\_

Country \_\_\_\_\_

**FISHERPAYKEL.COM**

© Fisher & Paykel Appliances 2024. All rights reserved.

The models shown in this guide may not be available in all markets  
and are subject to change at any time.

The product specifications in this guide apply to the specific products and  
models described at the date of issue. Under our policy of continuous product  
improvement, these specifications may change at any time.

For current details about model and specification availability in your country,  
please go to our website or contact your local Fisher & Paykel dealer.

**428315B 04.24**