

17.1 cu ft Series 5 Refrigerator Freezer

Series 5 | Contemporary

Stainless Steel | Left hinge



This stylish left hinge refrigerator has a large capacity and comes in timeless stainless steel.

- Brushed metal handles
- ActiveSmart™ helps keep food fresher for longer
- Bottom freezer drawer

DIMENSIONS

Height	67 3/4 "
Width	31 1/8 "
Depth	27 3/8 "

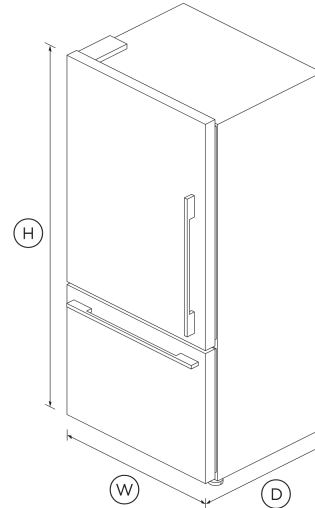

FEATURES & BENEFITS

Activesmart™ Foodcare

ActiveSmart™ Foodcare learns how you live. It's technology which understands how you use your refrigerator and adjusts temperature, airflow and humidity inside to help keep food fresher for longer.

Easy Cleaning

No more permanent dirty marks with our EZKleen feature for stainless steel refrigerators. Anti-fingerprint coating means you simply wipe clean any marks. Spill-safe secure glass shelves easily capture any drips or leaks.

Design Quality

Our refrigerators are designed and built using quality materials. We use real stainless steel on our refrigerators and solid glass for shelving.

Simple Storage

There are multiple storage options for you to choose from. Different sized adjustable shelves and door storage give you plenty of room to stack and pack all your groceries. Storage bins give you full access inside when they're pulled open and can be easily removed to clean.

Clever Energy

Your refrigerator adapts to daily use by cooling and defrosting only when needed. This means your refrigerator uses the energy it needs without compromising on food care.

SPECIFICATIONS

Accessories (sold separately)

Joiner Kit	819264
Surround Kit (Joined left/right pair)	Part number 24476
Surround Kit (Right Hand)	Part number 24475

Capacity

Total gross capacity	17.1 cu ft
Volume freezer	4.8 cu ft
Volume refrigerator	12.3 cu ft

Consumption

Energy rating	Energy star
Energy usage	452kWh/year

In-use energy carbon emissions estimate **55.7kgCO2e/year**

Supply frequency **60 Hz**

Supply voltage **115 V**

Features

Adjustable door shelves	13
Adjustable glass shelves	4
Covered door shelves	2
Door alarm	•
Fruit and vegetable bins	2
LED lighting	•
Smart appliance	•
SmartTouch control panel	•
Stackable bottle holders	2

Product dimensions

Depth	27 3/8 "
Height	67 3/4 "
Minimum air clearance at rear	1 3/16 "
Minimum air clearance each side	1 3/16 "
Width	31 1/8 "

Warranty

Parts and labor	2 years
Sealed system parts & labor	additional 3 years

SKU **26295**

The product dimensions and specifications in this page apply to the specific product and model. Under our policy of continuous improvement, these dimensions and specifications may change at any time. You should therefore check with Fisher & Paykel's Customer Care Centre to ensure this page correctly describes the model currently available. © Fisher & Paykel Appliances Ltd 2020

Other product downloads available at fisherpaykel.com

- [↓ 2D-DWG Freestanding Refrigerator Freezer](#)
- [↓ 2D-DXF Freestanding Refrigerator Freezer](#)
- [↓ Data Sheet Freestanding Refrigerator Freezer](#)
- [↓ Energy Label](#)

- [↓ Service & Warranty](#)
- [↓ Installation Guide - Quick Reference EN](#)
- [↓ Installation Guide Refrigerator Freezer EN](#)
- [↓ Installation Guide - Joiner Kit EN](#)
- [↓ Water Filter Replacement Instructions - Parts 847200 and 847201 - FR](#)
- [↓ Installation Guide - Joiner Kit FR](#)
- [↓ User Guide Refrigerator Freezer EN](#)
- [↓ User Guide Refrigerator Freezer FR](#)

Where applicable:

All appliances use energy, and energy usage typically generates carbon emissions. **Fisher & Paykel Appliances' In-use Energy Carbon Emissions Estimate** indicates carbon emissions from a product's in-use energy. This is calculated either annually or per cycle, using the product's market-specific energy label energy consumption data multiplied by the carbon emissions factor for energy in your country or region.

Our In-use Energy Carbon Emissions Estimate is designed to assist customers in making informed purchasing decisions when comparing different Fisher & Paykel products. For example, a heat pump dryer typically has a lower In-use Energy Carbon Emissions Estimate than a vented dryer.



A PEACE OF MIND SALE
24 Hours 7 Days a Week Customer Support
 T 1.888.936.7872 [Wwww.fisherpaykel.com](http://www.fisherpaykel.com)

Performance

ActiveSmart™ Foodcare	•
Adaptive defrost	•
Frost free freezer	•
Humidity control system	•
Sabbath mode	•

Power requirements

Rated current **10 A**