

Series 11, Integrated Tall Double DishDrawer Dishwasher

Series 11 | Integrated

Panel Ready



<p>Integrates seamlessly into kitchen cabinetry. Each drawer features a premium stainless steel interior and operates independently, for flexible washing.</p>

- Eight wash cycles from Heavy to Light, including Auto, 60min and Glassware
- Tall top drawer fits full-size dinner plates up to 12 1/4 inches, with flexible racking for large cookware

- With soft-close drawers, and knock to pause convenience
- Wi-Fi capability and a SmartHQ™ app for remote control and notifications

DIMENSIONS

Height	34 - 36 3/8 "
Width	23 9/16 "
Depth	22 1/2 "

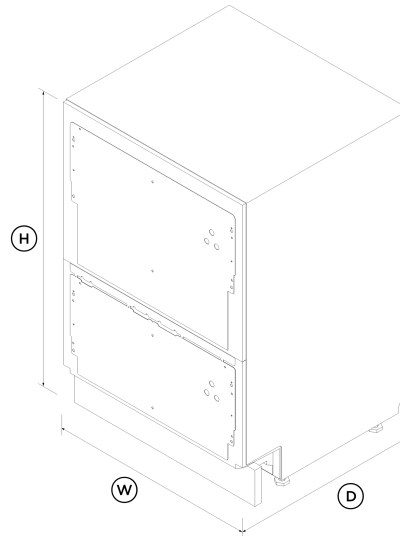

FEATURES & BENEFITS

Seamless Integration

Install your DishDrawer™ Dishwasher into an existing kitchen space or integrate into kitchen cabinetry. The touch-sensitive control panel is located inside this Integrated model, leaving an uninterrupted exterior that blends seamlessly with surrounding cabinetry.

Ease Of Use

DishDrawer™ Dishwashers are beautiful to use with soft-close drawers. The tall top drawer fits your larger plates and dishes up to 12 1/4 inches, while the bottom drawer is ideal for small washes. Flexible racking includes height-adjustable cup racks and wine glass supports.

True Half Load

Both drawers fit a true half load. Each drawer operates independently, so you can wash one load while stacking the other drawer, or wash simultaneously on separate cycles.

Flexible Wash Options

Eight wash programs including Auto, 60min and Glassware, while modifiers such as Sanitize, Dry+ and Quiet provide added wash flexibility. The Quiet wash modifier reduces the noise on some cycles while maintaining performance - perfect for late night washing.

Design Quality

Every detail has been carefully crafted using quality materials, from the easy-to-clean stainless steel interior to the spray arm sensor that detects jams for increased wash confidence.

Knock To Pause

For ease-of-use, these DishDrawer™ Dishwashers have a knock to pause function. A knock on the front panel will pause the dishwasher, which can be restarted by using the start button.

Efficient performance

With a Energy Star Most Efficient rating, this DishDrawer™ Dishwasher is recognised amongst the most energy efficient models on the market.

SPECIFICATIONS

Accessories (included)

Cutlery basket	•
Kickstrip	true
Knife clip and multipurpose clip	•

Accessories (sold separately)

Door panel stainless steel	ADDD24DTPX
Handle kit Classic	AHCL-DDDW-24X
Handle kit Contemporary round, aluminium	AHS-OBDD-60S
Handle kit Contemporary square fine, aluminium	AHD5-OBDD-60SX
Handle kit Contemporary square fine, black	AHD5-OBDD-60SB
Handle kit Contemporary square, aluminium	AHD3-OBDD-60S
Handle kit Professional round flush	AHP3-DWDD-SX
Handle kit Professional round flush, Brass off-stands	AHP3DDDW24BA
Handle kit Professional round flush, Dark Copper off-stands	AHP3DDDW24DC

Capacity and loading

Accommodates round plates up to	12.25" (top) 11" (bottom)
Adjustable height, foldable cupracks	•
Fold down tines	•
Pitch adjustable tines	•
Place settings	14
Place settings	14
Wine glass supports with stemware grippers	•

Consumption

Energy rating	Energy star Most efficient
Energy usage	225kWh/year
In-use energy carbon emissions estimate	82.5kgCO2e/year
Water usage (per wash cycle)	3.1 gal

Controls

Electronic fault/Diagnostic indicator	•
End of cycle beeps	•
Energy saving delay start option of up to 12 hours	•
Internal wash selector	•
Intuitive capacitive touch controls	•
Keylock	•
Knock to pause	•
Rinse aid indicator light	•
Smart appliance	•
Spray arm sensing	•

Features

Fan assisted drying	•
Flood protection	•
Flow through detergent dispenser	•
Internal tub material	Stainless steel
Quiet operation	•
SmartDrive™ technology	•
Soft close drawer	•

Performance

Noise on standard cycle top drawer	44 dBA
------------------------------------	---------------

Power Requirements

Amperage	10A
Rated current	15 A
Supply frequency	60Hz
Supply voltage	100 - 120V

Product Dimensions

Depth	22 1/2 "
Height	34 - 36 3/8 "
Width	23 9/16 "

Warranty

Parts and labor	Limited 2 years
-----------------	------------------------

Wash Program Modifiers

Dry +	•
Quiet	•
Sanitise	•
Wash modifiers	3

Wash Programs

60 min	•
Auto	•

Eco	•
Glassware	•
Heavy	•
Light	•
Medium	•
Rinse	•
Wash programs	8

- [↓](#) Energy Label Double DishDrawer™ Dishwasher
- [↓](#) Service & Warranty
- [↓](#) Planning Guide Integrated Double DishDrawer™
- [↓](#) Planning Guide Professional Style Dial/Handle Accessories
- [↓](#) Specification Guide
- [↓](#) User Guide DishDrawer™ Dishwasher EN
- [↓](#) Guide d'utilisation FR
- [↓](#) Wash Program Data Sheet EN

Water connection

Inlet water temperature	Max 140 °F
Supplied hose to suit 3/8" (9mm) male compression fitting	•
Water pressure	30kPa - 1000 kPa
Water supply	3/8" to suit Male Compression Fitting

Where applicable:

All appliances use energy, and energy usage typically generates carbon emissions. **Fisher & Paykel Appliances' In-use Energy Carbon Emissions Estimate** indicates carbon emissions from a product's in-use energy. This is calculated either annually or per cycle, using the product's market-specific energy label energy consumption data multiplied by the carbon emissions factor for energy in your country or region.

Our In-use Energy Carbon Emissions Estimate is designed to assist customers in making informed purchasing decisions when comparing different Fisher & Paykel products. For example, a heat pump dryer typically has a lower In-use Energy Carbon Emissions Estimate than a vented dryer.

SKU 82162



A PEACE OF MIND SALE
24 Hours 7 Days a Week Customer Support
 T 1.888.936.7872 W www.fisherpaykel.com

The product dimensions and specifications in this page apply to the specific product and model. Under our policy of continuous improvement, these dimensions and specifications may change at any time. You should therefore check with Fisher & Paykel's Customer Care Centre to ensure this page correctly describes the model currently available. © Fisher & Paykel Appliances Ltd 2020

Other product downloads available at fisherpaykel.com

- [↓](#) Wash Program Data Sheet
- [↓](#) 2D-DWG Integrated Double DishDrawer™ Dishwasher
- [↓](#) 2D-DXF Integrated Double DishDrawer™ Dishwasher